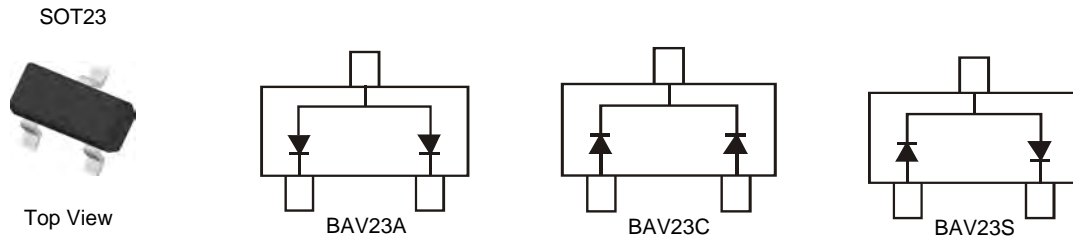

SURFACE MOUNT HIGH VOLTAGE DUAL SWITCHING DIODE
Features

- Fast Switching Speed
- Surface Mount Package Ideally Suited for Automated Insertion
- High Reverse Breakdown Voltage
- Low Leakage Current
- **Lead, Halogen and Antimony Free, RoHS Compliant "Green" Device (Notes 1 and 2)**
- **Qualified to AEC-Q101 Standards for High Reliability**

Mechanical Data

- Case: SOT23
- Case Material: Molded Plastic. UL Flammability Classification Rating 94V-0
- Moisture Sensitivity: Level 1 per J-STD-020
- Lead Free Plating (Matte Tin Finish annealed over Alloy 42 leadframe).
- Polarity: See Diagrams Below
- Weight: 0.008 grams (approximate)

Ordering Information (Note 3)

Part Number	Qualification	Case	Packaging
BAV23A-7-F	Commercial	SOT23	3,000/Tape & Reel
BAV23A-13-F	Commercial	SOT23	10,000/Tape & Reel
BAV23AQ-7-F	Automotive	SOT23	3,000/Tape & Reel
BAV23AQ-13-F	Automotive	SOT23	10,000/Tape & Reel
BAV23C-7-F	Commercial	SOT23	3,000/Tape & Reel
BAV23C-13-F	Commercial	SOT23	10,000/Tape & Reel
BAV23CQ-7-F	Automotive	SOT23	3,000/Tape & Reel
BAV23CQ-13-F	Automotive	SOT23	10,000/Tape & Reel
BAV23S-7-F	Commercial	SOT23	3,000/Tape & Reel
BAV23S-13-F	Commercial	SOT23	10,000/Tape & Reel
BAV23SQ-13-F	Automotive	SOT23	10,000/Tape & Reel

- Notes:
1. No purposefully added lead. Halogen and Antimony Free.
 2. Product manufactured with Date Code V9 (week 33, 2008) and newer are built with Green Molding Compound. Product manufactured prior to Date Code V9 are built with Non-Green Molding Compound and may contain Halogens or Sb₂O₃ Fire Retardants.
 3. For packaging details, go to our website at <http://www.diodes.com>.

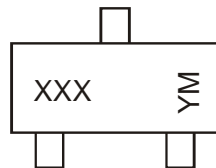
Marking Information

XXX = Product Type Marking Code
 ex. KT7 = BAV23A
 KT6 = BAV23C
 KL31 = BAV23S
 YM = Date Code Marking
 Y = Year (ex: Y = 2011)
 M = Month (ex: 9 = September)

Date Code Key

Year	2003	2004	2005	2006	2007	2008	2009	2010	2011	2012	2013	2014	2015	2016	2017
Code	P	R	S	T	U	V	W	X	Y	Z	A	B	C	D	E

Month	Jan	Feb	Mar	Apr	May	Jun	Jul	Aug	Sep	Oct	Nov	Dec
Code	1	2	3	4	5	6	7	8	9	O	N	D

Maximum Ratings @ $T_A = 25^\circ\text{C}$ unless otherwise specified

Characteristic	Symbol	Value	Unit
Repetitive Peak Reverse Voltage	V_{RRM}	250	V
Working Peak Reverse Voltage	V_{RWM}	200	V
DC Blocking Voltage	V_R	141	V
RMS Reverse Voltage	$V_{R(RMS)}$	141	V
Forward Continuous Current (Note 4)	I_{FM}	400	mA
Non-Repetitive Peak Forward Surge Current	I_{FSM}	@ $t = 1.0\mu\text{s}$	9.0
		@ $t = 100\mu\text{s}$	3.0
		@ $t = 10\text{ms}$	1.7
Repetitive Peak Forward Surge Current (Note 4)	I_{FRM}	625	mA

Thermal Characteristics

Characteristic	Symbol	Value	Unit
Power Dissipation (Note 4)	P_D	350	mW
Thermal Resistance Junction to Ambient Air (Note 4)	$R_{\theta JA}$	357	$^\circ\text{C/W}$
Operating and Storage Temperature Range	T_J, T_{STG}	-65 to +150	$^\circ\text{C}$

Electrical Characteristics @ $T_A = 25^\circ\text{C}$ unless otherwise specified

Characteristic	Symbol	Min	Max	Unit	Test Condition
Reverse Breakdown Voltage (Note 5)	$V_{(BR)R}$	250	—	V	$I_R = 100\mu\text{A}$
Forward Voltage	V_F	—	1.0	V	$I_F = 100\text{mA}$
		—	1.25		$I_F = 200\text{mA}$
Reverse Current (Note 5)	I_R	—	100	nA	$V_R = 200\text{V}, T_J = 25^\circ\text{C}$
		—	100	μA	$V_R = 200\text{V}, T_J = 150^\circ\text{C}$
Total Capacitance	C_T	—	5.0	pF	$V_R = 0, f = 1.0\text{MHz}$
Reverse Recovery Time	t_{rr}	—	50	ns	$I_F = I_R = 30\text{mA}, I_{tr} = 0.1 \times I_R, R_L = 100\Omega$

Notes: 4. Part mounted on FR-4 board with recommended pad layout, which can be found on our website at <http://www.diodes.com>.
5. Short duration pulse test used to minimize self-heating effect.

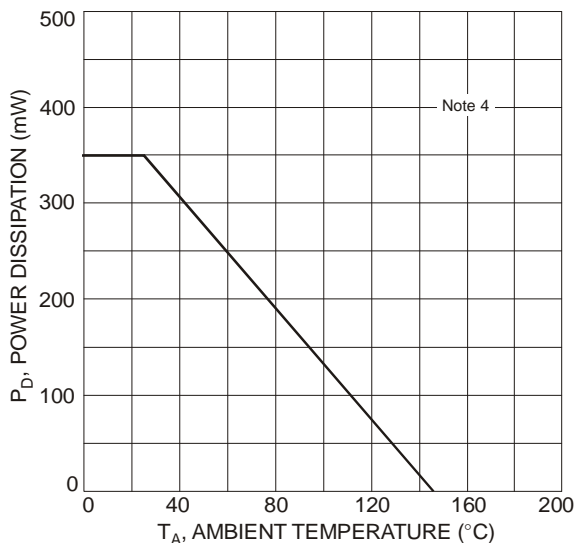

Fig. 1 Power Derating Curve, Total Package

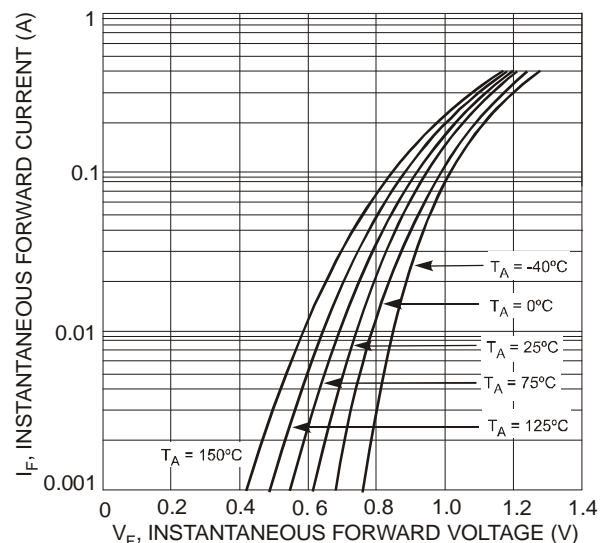

Fig. 2 Typical Forward Characteristics, Per Element

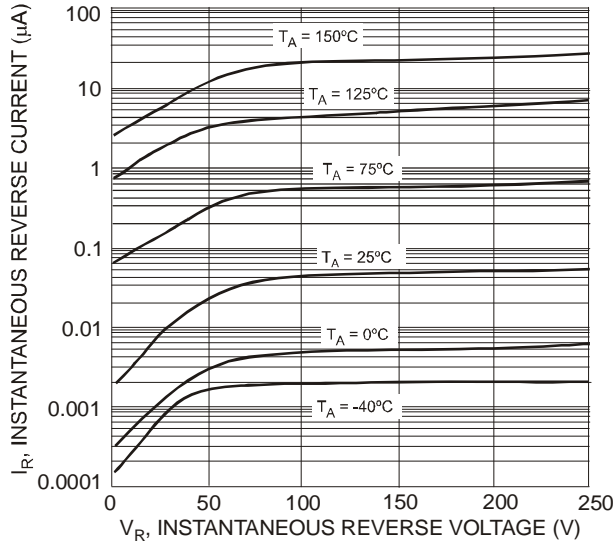

Fig. 3 Typical Reverse Characteristics, Per Element

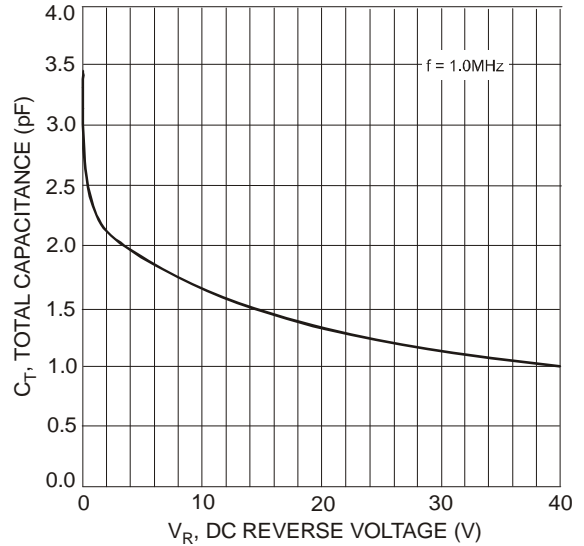
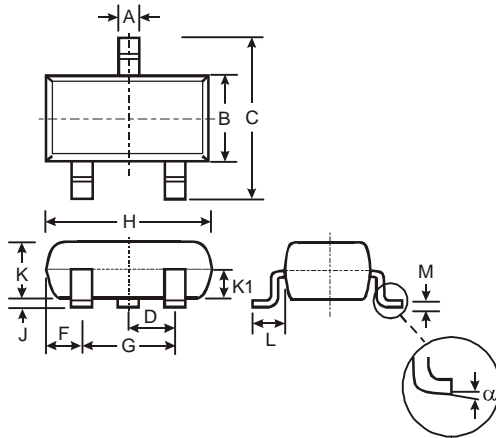

Fig. 4 Total Capacitance vs. Reverse Voltage, Per Element

Package Outline Dimensions



SOT23			
Dim	Min	Max	Typ
A	0.37	0.51	0.40
B	1.20	1.40	1.30
C	2.30	2.50	2.40
D	0.89	1.03	0.915
F	0.45	0.60	0.535
G	1.78	2.05	1.83
H	2.80	3.00	2.90
J	0.013	0.10	0.05
K	0.903	1.10	1.00
K1	-	-	0.400
L	0.45	0.61	0.55
M	0.085	0.18	0.11
α	0°	8°	-
All Dimensions in mm			

Suggested Pad Layout

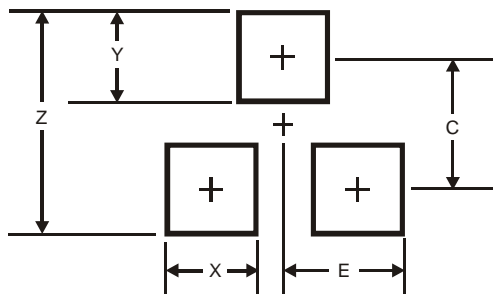

Dimensions	Value (in mm)
Z	2.9
X	0.8
Y	0.9
C	2.0
E	1.35

IMPORTANT NOTICE

DIODES INCORPORATED MAKES NO WARRANTY OF ANY KIND, EXPRESS OR IMPLIED, WITH REGARDS TO THIS DOCUMENT, INCLUDING, BUT NOT LIMITED TO, THE IMPLIED WARRANTIES OF MERCHANTABILITY AND FITNESS FOR A PARTICULAR PURPOSE (AND THEIR EQUIVALENTS UNDER THE LAWS OF ANY JURISDICTION).

Diodes Incorporated and its subsidiaries reserve the right to make modifications, enhancements, improvements, corrections or other changes without further notice to this document and any product described herein. Diodes Incorporated does not assume any liability arising out of the application or use of this document or any product described herein; neither does Diodes Incorporated convey any license under its patent or trademark rights, nor the rights of others. Any Customer or user of this document or products described herein in such applications shall assume all risks of such use and will agree to hold Diodes Incorporated and all the companies whose products are represented on Diodes Incorporated website, harmless against all damages.

Diodes Incorporated does not warrant or accept any liability whatsoever in respect of any products purchased through unauthorized sales channel. Should Customers purchase or use Diodes Incorporated products for any unintended or unauthorized application, Customers shall indemnify and hold Diodes Incorporated and its representatives harmless against all claims, damages, expenses, and attorney fees arising out of, directly or indirectly, any claim of personal injury or death associated with such unintended or unauthorized application.

Products described herein may be covered by one or more United States, international or foreign patents pending. Product names and markings noted herein may also be covered by one or more United States, international or foreign trademarks.

LIFE SUPPORT

Diodes Incorporated products are specifically not authorized for use as critical components in life support devices or systems without the express written approval of the Chief Executive Officer of Diodes Incorporated. As used herein:

A. Life support devices or systems are devices or systems which:

1. are intended to implant into the body, or
2. support or sustain life and whose failure to perform when properly used in accordance with instructions for use provided in the labeling can be reasonably expected to result in significant injury to the user.

B. A critical component is any component in a life support device or system whose failure to perform can be reasonably expected to cause the failure of the life support device or to affect its safety or effectiveness.

Customers represent that they have all necessary expertise in the safety and regulatory ramifications of their life support devices or systems, and acknowledge and agree that they are solely responsible for all legal, regulatory and safety-related requirements concerning their products and any use of Diodes Incorporated products in such safety-critical, life support devices or systems, notwithstanding any devices- or systems-related information or support that may be provided by Diodes Incorporated. Further, Customers must fully indemnify Diodes Incorporated and its representatives against any damages arising out of the use of Diodes Incorporated products in such safety-critical, life support devices or systems.

Copyright © 2011, Diodes Incorporated

www.diodes.com