



FAN4147

Ground Fault Interrupter

Features

- For GFCI and RCD Applications
- Precision Sense Amplifier and Bandgap Reference
- Built-in AC Rectifier
- Built-in Noise Filter
- Low-Voltage SCR Disable
- Direct DC Coupled to Sense Coil
- SCR Gate Driver
- Adjustable Sensitivity
- 400 μ A Quiescent Current
- Minimum External Components
- Meets UL 943 Requirements
- Ideal for 120V or 220V Systems
- Space Saving SuperSOT™ 6-Pin Package

Applications

- GFCI Output Receptacles
- GFCI Circuit Breakers
- Portable GFCI Cords

Description

The FAN4147 is a low-power Ground Fault Interrupter (GFI) controller for detecting hazardous current paths to ground and ground-to-neutral faults. The FAN4147 application circuit opens the load contacts before a harmful shock occurs.

Internally, the FAN4147 contains a diode rectifier, precision bandgap 12V shunt regulator, precision low- V_{OS} offset-sense amplifier, time delay noise filter, window-detection comparators, and an SCR driver. With a minimum number of external components, the FAN4147 detects and protects against a hot-wire-to-ground fault and a neutral-line-to-neutral-load short. The minimal components and the small SuperSOT™ package allow for a small-form-factor, low-cost solution.

The FAN4147 circuitry has a built-in rectifier and shunt regulator that operates with a low quiescent current. This allows for a high-value, low-wattage-series supply resistor. The internal temperature-compensated shunt regulator, sense amplifier, and bias circuitry provide for precision ground-fault detection. The low- V_{OS} offset-sense amplifier allows direct coupling of the sense coil to the amplifier's feedback signal. This eliminates the large 50/60Hz AC-coupling capacitor. The internal delay filter rejects high-frequency noise spikes common with inductive loads. This decreases false nuisance tripping. The internal SCR driver is temperature compensated and designed to satisfy the current requirements for a wide selection of external SCRs.

The minimum number of external components and the 6-pin SuperSOT™ package enable a low-cost, compact design and layout.

Ordering Information

Part Number	Operating Temperature Range	Package	Packing Method
FAN4147SX	-35°C to +85°C	6-Lead SUPERSOT6, JEDEC M0-193, 1.6mm	Tape and Reel

Block Diagram

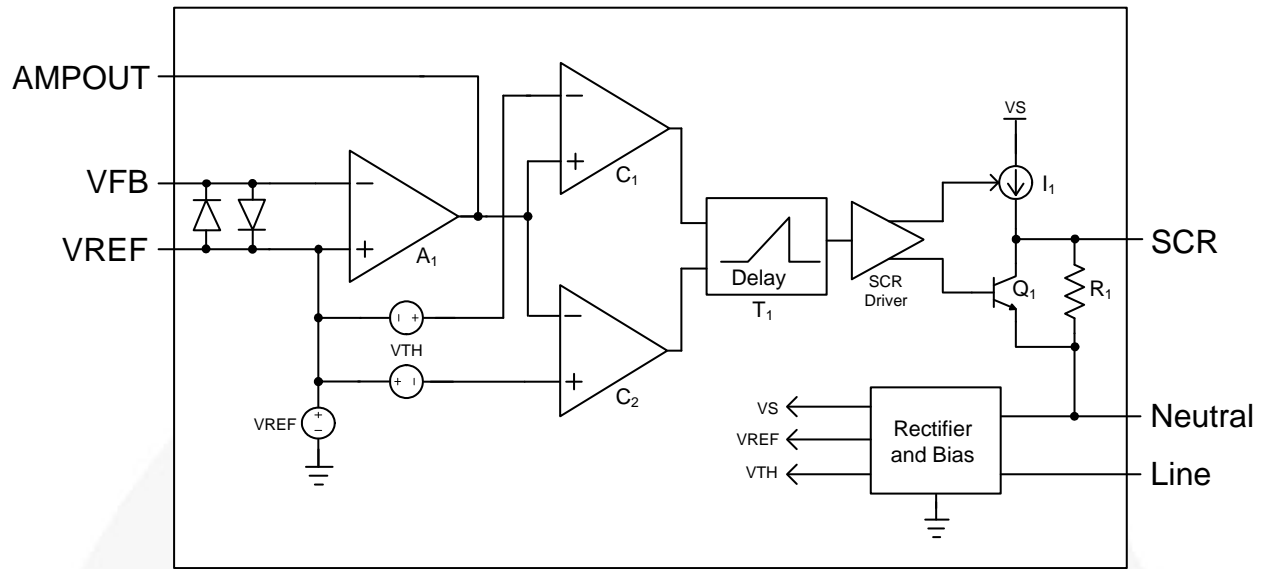

Figure 1. Block Diagram

Typical Application

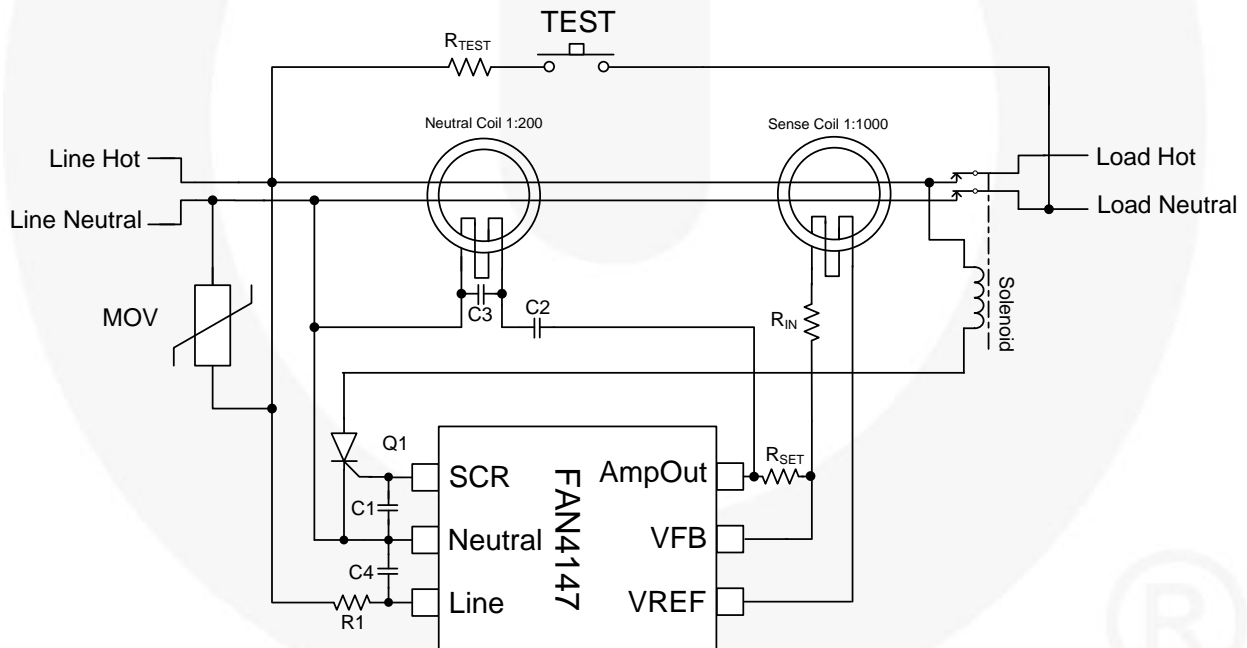

Figure 2. Typical Application⁽¹⁾

Typical Values

R1: 91KΩ □	R _{SET} : 511KΩ □ ⁽²⁾	C1: 22nF	C3=1nF
R _{TEST} : 15KΩ	R _{IN} : 470Ω	C2: 10nF	C4=10nF

Notes:

1. Contact Fairchild for best application practices for nuisance tripping rejection.
2. Exact values depend on sense coil characteristics and application.

Pin Configuration

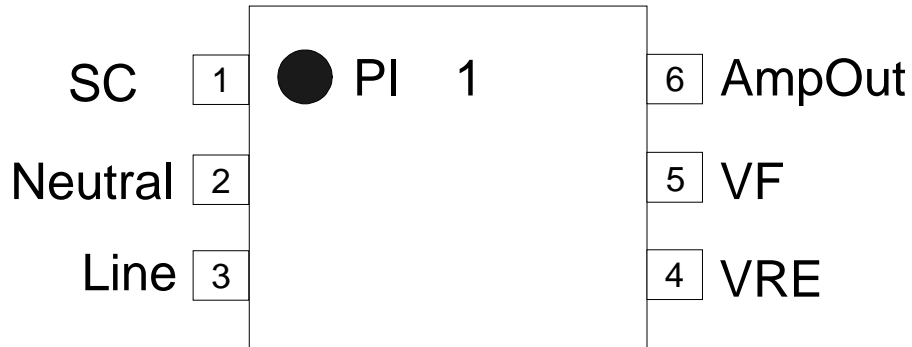

Figure 3. Pin Configuration

Pin Definitions

Pin #	Name	Description
1	SCR	Gate drive for external SCR
2	Neutral	Supply input for FAN4147 circuitry
3	Line	Supply input for FAN4147 circuitry
4	VREF	Non-inverting input for current-sense amplifier
5	VFB	Inverting input for current-sense amplifier
6	AmpOut	An external resistor connected to the VFB pin sets the I_{fault} sensitivity threshold

Absolute Maximum Ratings

Stresses exceeding the absolute maximum ratings may damage the device. The device may not function or be operable above the recommended operating conditions and stressing the parts to these levels is not recommended. In addition, extended exposure to stresses above the recommended operating conditions may affect device reliability. The absolute maximum ratings are stress ratings only.

Symbol	Parameter	Min.	Max.	Unit	
I_{CC}	Continuous Supply Current, Line to Neutral		15	mA	
V_{CC}	Continuous Supply Voltage, Line to Neutral	-1.2	16	V	
	Continuous Voltage to Neutral, All Other Pins	-0.8	15	V	
T_{STG}	Storage Temperature Range	-65	+150	°C	
ESD	Electrostatic Discharge Protection Level	Human Body Model, JESD22-A114		2.5	kV
		Charged Device Model, JESD22-C101		1.0	
		Machine Model, JESD22-A115		0.2	

Recommended Operating Conditions

The Recommended Operating Conditions define conditions for actual device operation. Recommended operating conditions are specified to ensure optimal performance to the datasheet specifications. Fairchild does not recommend exceeding them or designing to Absolute Maximum Ratings. (Unless otherwise specified, refer to figure 2.)

Symbol	Parameter	Conditions	Min.	Typ.	Max.	Unit
DC Electrical Parameters ($T_A=25^\circ\text{C}$, $I_{shunt}=1\text{mA}$)						
V_{REG}	Power Supply Shunt Regulator Voltage	Line to Neutral	12.2	12.7	13.2	V
		Line to Neutral $I_{shunt}=-2\text{mA}$	-0.9	-0.7		V
I_Q	Quiescent Current	Line to Neutral=10V	350	400	450	μA
V_{REF}	Reference Voltage	VREF to Neutral	5.8	6.0	6.2	V
V_{TH}	Trip Threshold	AmpOut to VREF	3.4	3.5	3.6	V
V_{OS}	Amplifier Offset	Gain=1000	-450	0	450	μV
I_{OS}	Amplifier Input Offset ⁽³⁾	Design Value	-50	0	50	nA
G	Amplifier DC Gain ⁽³⁾	Design Value		100		dB
f_{GBW}	Amplifier Gain Bandwidth ⁽³⁾	Design Value		1.5		MHz
V_{SW+}	Amplifier Positive Voltage Swing	AmpOut to VREF, $I_{FAULT}=10\mu\text{A}$	4.0			V
V_{SW-}	Amplifier Negative Voltage Swing	VREF to AmpOut, $I_{FAULT}=-10\mu\text{A}$	4.0			V
I_{SINK}	Amplifier Current Sink	AmpOut= $V_{REF} + 3\text{V}$, $V_{FB}=V_{REF} + 100\text{mV}$	400			μA
I_{SRL}	Amplifier Current Source	AmpOut= $V_{REF} - 3\text{V}$, $V_{FB}=V_{REF} - 100\text{mV}$	400			μA
t_d	Delay Filter	Delay from C_1 trip to SCR L->H	0.7	1.0	1.3	ms
R_{OUT}	SCR Output Resistance	SCR to Neutral=250mV, AmpOut= V_{REF}		0.5	1.0	$\text{K}\Omega$
V_{OUT}	SCR Output Voltage	SCR to Neutral AmpOut= V_{REF}		1	10	mV
		SCR to Neutral AmpOut= $V_{REF} + 4\text{V}$	2.5			V
I_{OUT}	SCR Output Current	SCR to Neutral=1V, AmpOut= $V_{REF} + 4\text{V}$	350	500		μA

Note:

3. Guaranteed by design; not tested in production.

Functional Description

(Refer to Figure 1 and Figure 2.)

The FAN4147 is a GFCI controller for AC ground-fault circuit interrupters. The internal rectifier circuit is supplied from the AC line during the positive half cycle of the AC line voltage. The internal 12V shunt regulator uses a precision temperature-compensated bandgap reference. The combination of precision reference circuitry and precision sense amplifier provides for an accurate ground-fault tolerance. This allows for selection of external components with wider, lower-cost, parameter variations. Due to the low quiescent current, a high-value external series resistor (R1) can be used, which reduces the maximum power wattage required. The 12V shunt regulator generates the reference voltage for the sense amplifier's (A₁) non-inverting input (AC ground reference) and supplies the bias for the delay timer (T₁), comparators (C₁ & C₂), and SCR driver.

The secondary winding of the sense transformer is connected to pin 4 (VREF) and to a resistor R_{IN} directly DC connected to the inverting input of the sense amplifier at pin 5 (VFB). The feedback resistor (R_{SET}) converts the sense transformer's secondary current to a voltage at pin 6 (AmpOut). This voltage is compared to the internal window comparator (C₁ & C₂) and, when the AmpOut voltage exceeds the +/-V_{TH} threshold voltage, the window comparator triggers the internal delay timer. The output of the window comparator must stay HIGH for the duration of the t₁ timer. If the window comparator's output goes LOW, the internal delay timer starts a reset cycle. If the window comparator's output is still HIGH at the end of the t₁ pulse, the SCR driver enables the current source I₁ and disables Q₁. The current source I₁ then enables the external SCR, which energizes the solenoid, opens the contact switches to the load, and removes the hazardous ground fault. The window comparator allows for detection of a positive or negative I_{FAULT} signal independent from the phase of the line voltage.

The sense transformer typically has a toroidal core made of laminated steel rings or solid ferrite material. The secondary of the transformer is typically 800 to 1500 turns of #40 wire wound through the toroid. The primary is typically one to two turns made by passing the AC hot and neutral wires through the center of the toroid. When a ground fault exists, a difference exists between the current flowing in hot and neutral wires. The primary difference current, divided by the primary-to-secondary turns ratio, is the current that flows through the secondary wire of the transformer.

A grounded neutral condition occurs when the neutral-line is grounded at the neutral-load side.

Depending on the resistance of the grounded neutral connection, this condition causes the sense coil to detect a lower ground fault current. The detection of a ground-to-load-neutral fault relies on the principle of positive feedback. When this occurs, the sense and neutral coils are mutually coupled, which produces a positive feedback path around the sense amplifier. This positive feedback causes the sense amplifier to

oscillate. When the peak oscillation voltage exceeds the SCR trigger threshold, the internal delay timer is enabled. Since the amplifier's output signal is crossing the window comparator's trip threshold typically at 6KHz, the delay timer alternates between detection of a fault/no fault. The ratio of the fault/no-fault detection time interval determines if the SCR driver is enabled.

The sensitivity of the grounded neutral detection is changed by the neutral coil turns and C₂, C₃ values.

R_{SET} Resistor Calculation

The AmpOut signal must exceed the window comparator's V_{TH} threshold voltage for longer than the delay timer. Therefore:

$$V_{TH} = I_{FAULT} \times 1.41 \times R_{SET} \times C_{OS} (2\pi \times (t/2P)) / N \quad (1)$$

$$R_{SET} = (V_{TH} \times N) / (1.41 \times I_{FAULT} \times C_{OS} (\pi \times t/P)) \quad (2)$$

where:

$$V_{TH} = 3.5V;$$

$$I_{FAULT} = 5mA \text{ (UL943)};$$

$$t = 1ms \text{ (timer delay)};$$

$$P = \text{Period of the AC Line (1/60Hz)};$$

$$N = \text{Ratio of secondary to primary turns (1000:1)};$$

$$R_{SET} = 505K\Omega \text{ (511K}\Omega \text{ standard 1\% value).}^{(4)}$$

Note:

- In practice, the transformer is non-ideal, so R_{SET} may need to be adjusted by up to 30% to obtain the desired I_{fault} trip threshold.

V_{OS} Trip Threshold Error Calculation

Since the sense coil is DC connected to the feedback of the sense amplifier, the V_{OS} offset introduces an I_{fault} threshold error. This error can be calculated as:

%Error=

$$100 \times (V_{OS} \times R_{SET}) / (R_{IN} + R_{LDC} + R_{LAC}) / V_{TH} \quad (3)$$

where:

$$V_{OS} = +/-450\mu V \text{ (worse case)};$$

$$= +/-150\mu V \text{ (typical)};$$

$$R_{SET} = 511K\Omega;$$

$$R_{IN} = 470\Omega \text{ (typical value)};$$

$$R_{LDC} = 75\Omega \text{ (sense coil secondary DC resistance)};$$

$$R_{LAC} = 1.5K\Omega \text{ (AC}_{(j\omega L)} \text{ impedance of sense coil)} \\ \text{(L= 4H, f= 60Hz)};$$

$$V_{TH} = 3.5V;$$

$$\%Error = +/- 3.2\% \text{ (worst case)}; +/- 1.1\% \text{ (typical).}$$

Typical Performance Characteristics

Unless otherwise specified, results are $T_A=25^\circ\text{C}$ and according to Figure 2 with solenoid disconnected.

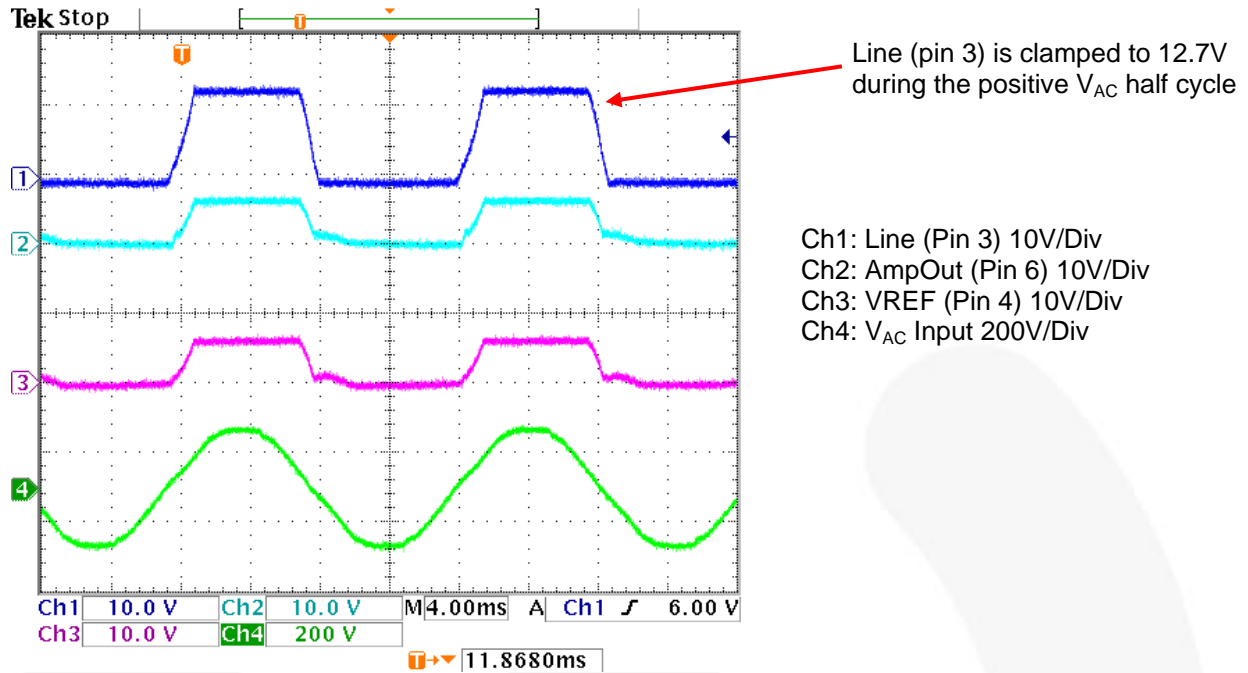

Figure 4. Typical Waveforms with No Ground Fault

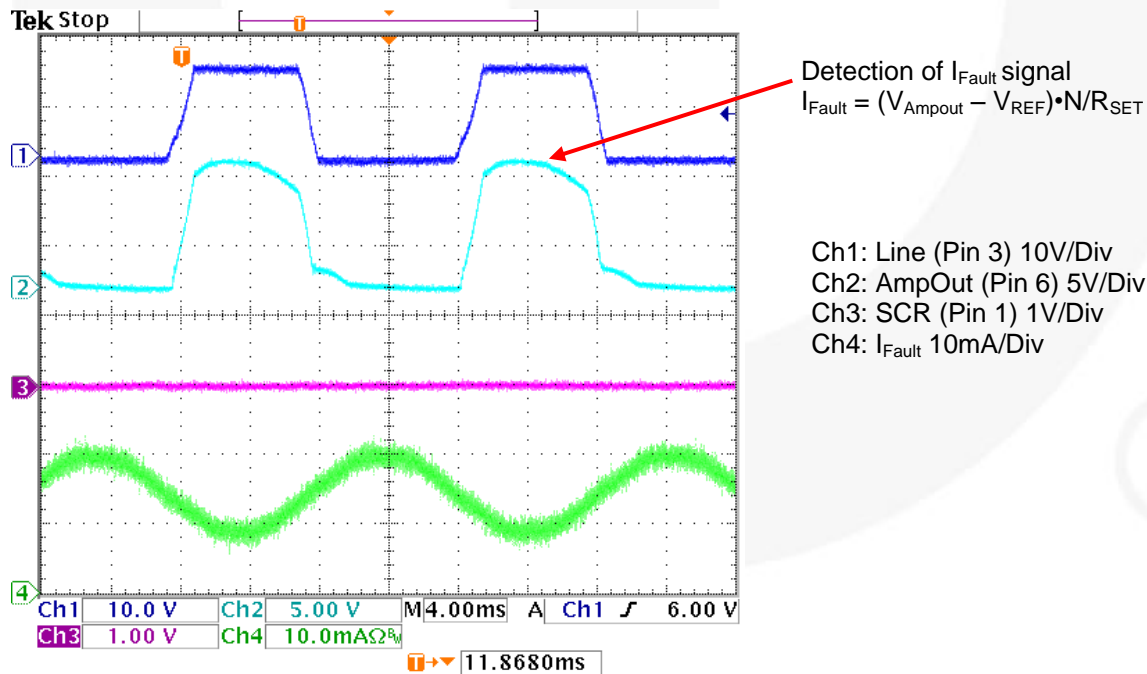

Figure 5. Typical Waveforms with 4mA Ground Fault

Typical Performance Characteristics

Unless otherwise specified, results are $T_A=25^\circ\text{C}$ and according to Figure 2 with solenoid disconnected.

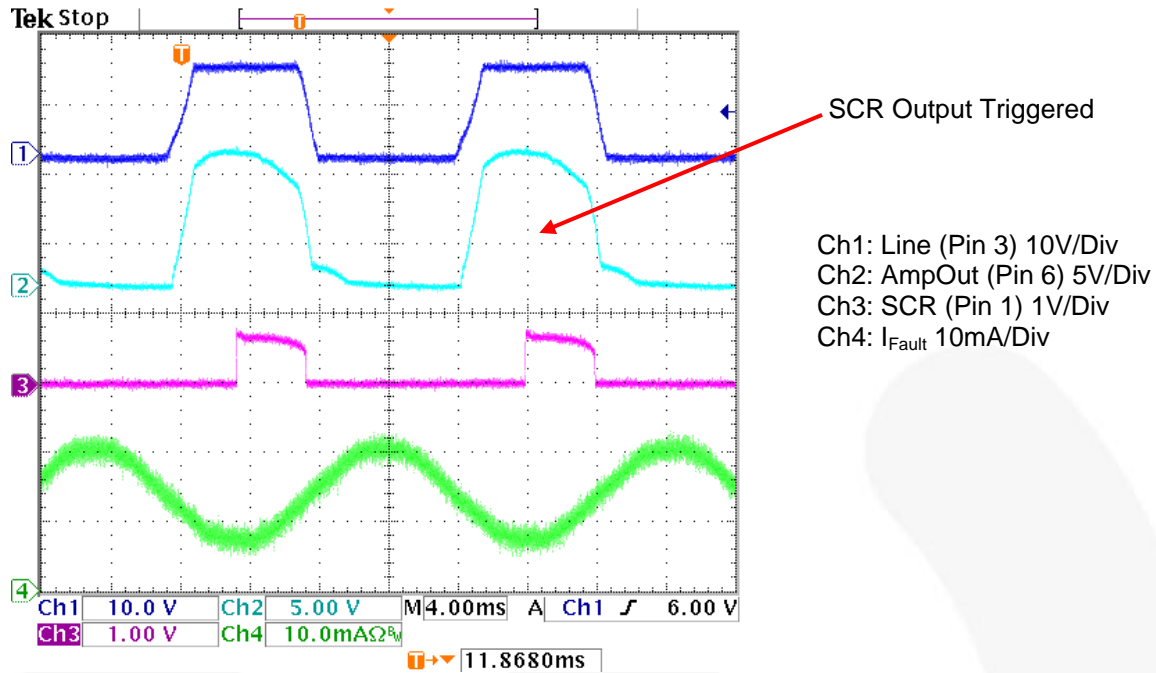

Figure 6. Typical Waveforms with 5mA Ground Fault

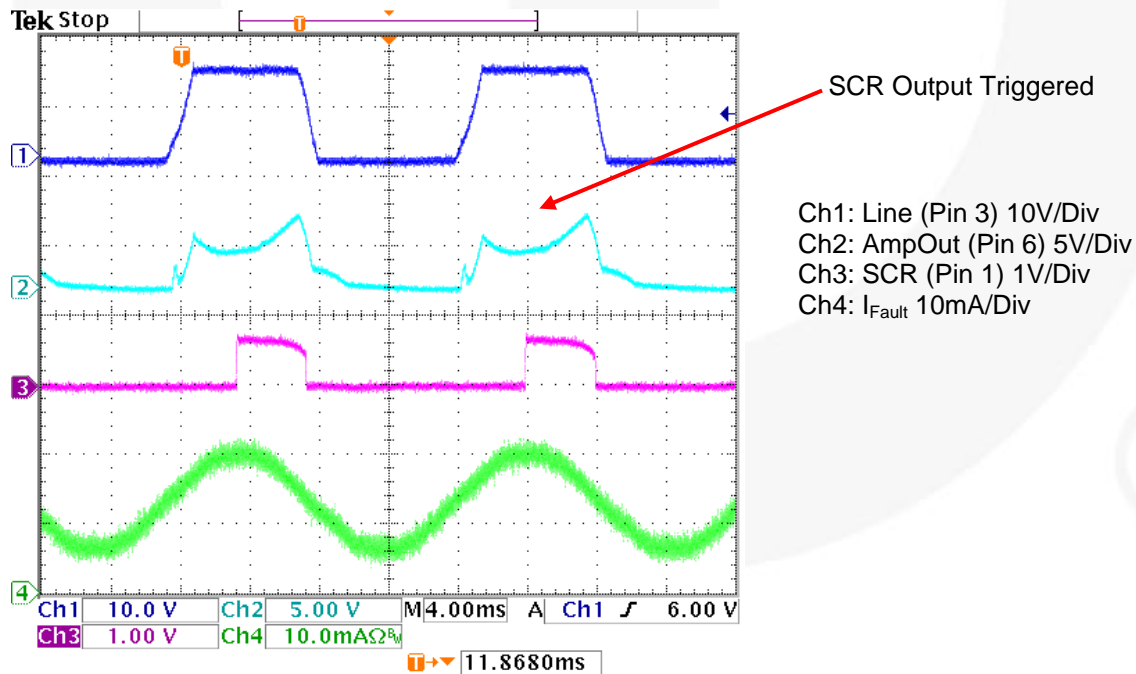

Figure 7. Typical Waveforms with 5mA Ground Fault (Line Polarity Reversal)

Typical Performance Characteristics

Unless otherwise specified, results are $T_A=25^\circ\text{C}$ and according to Figure 2 with solenoid disconnected.

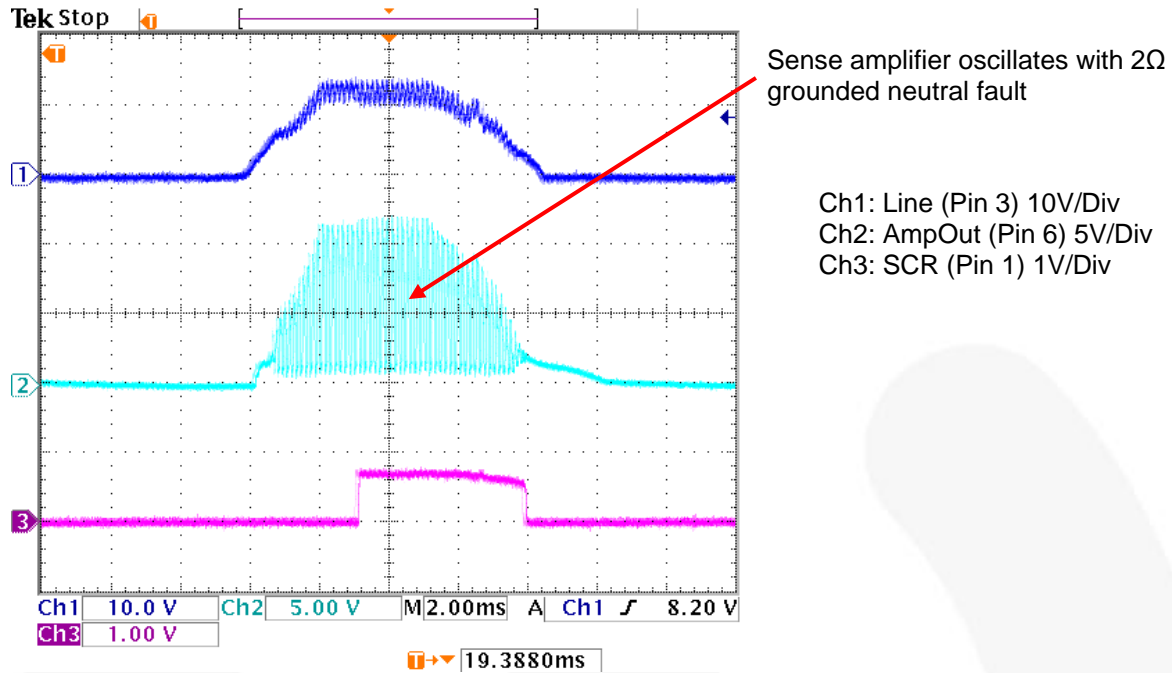

Figure 8. Typical Waveforms for Grounded Neutral Detection

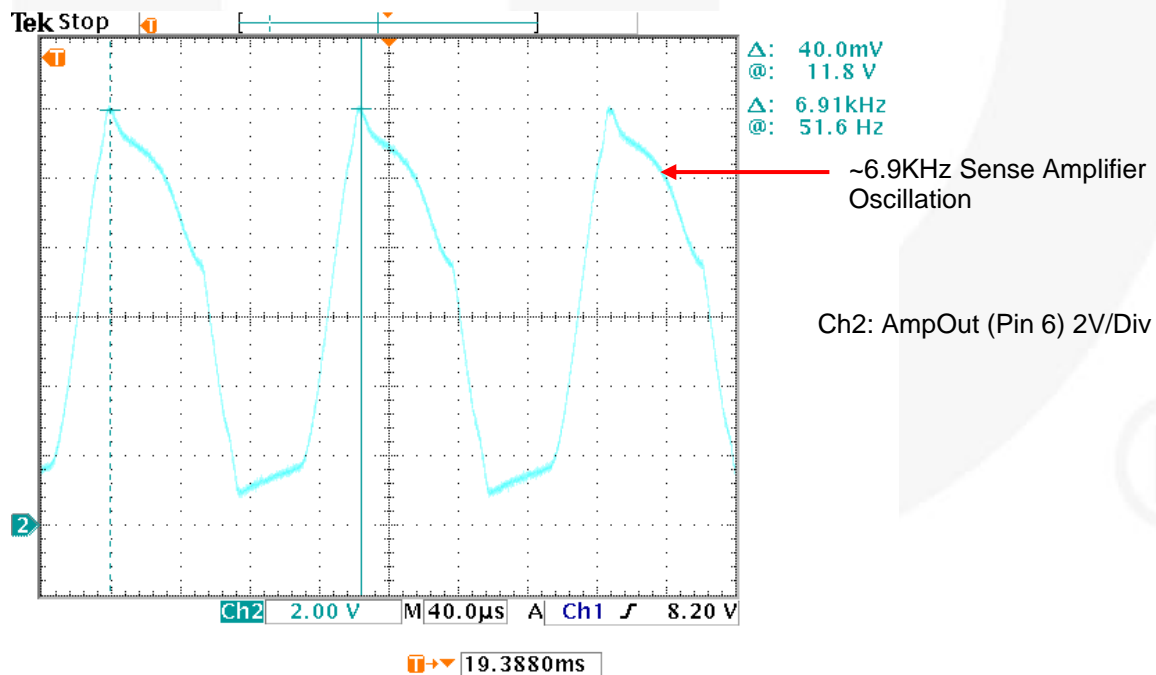
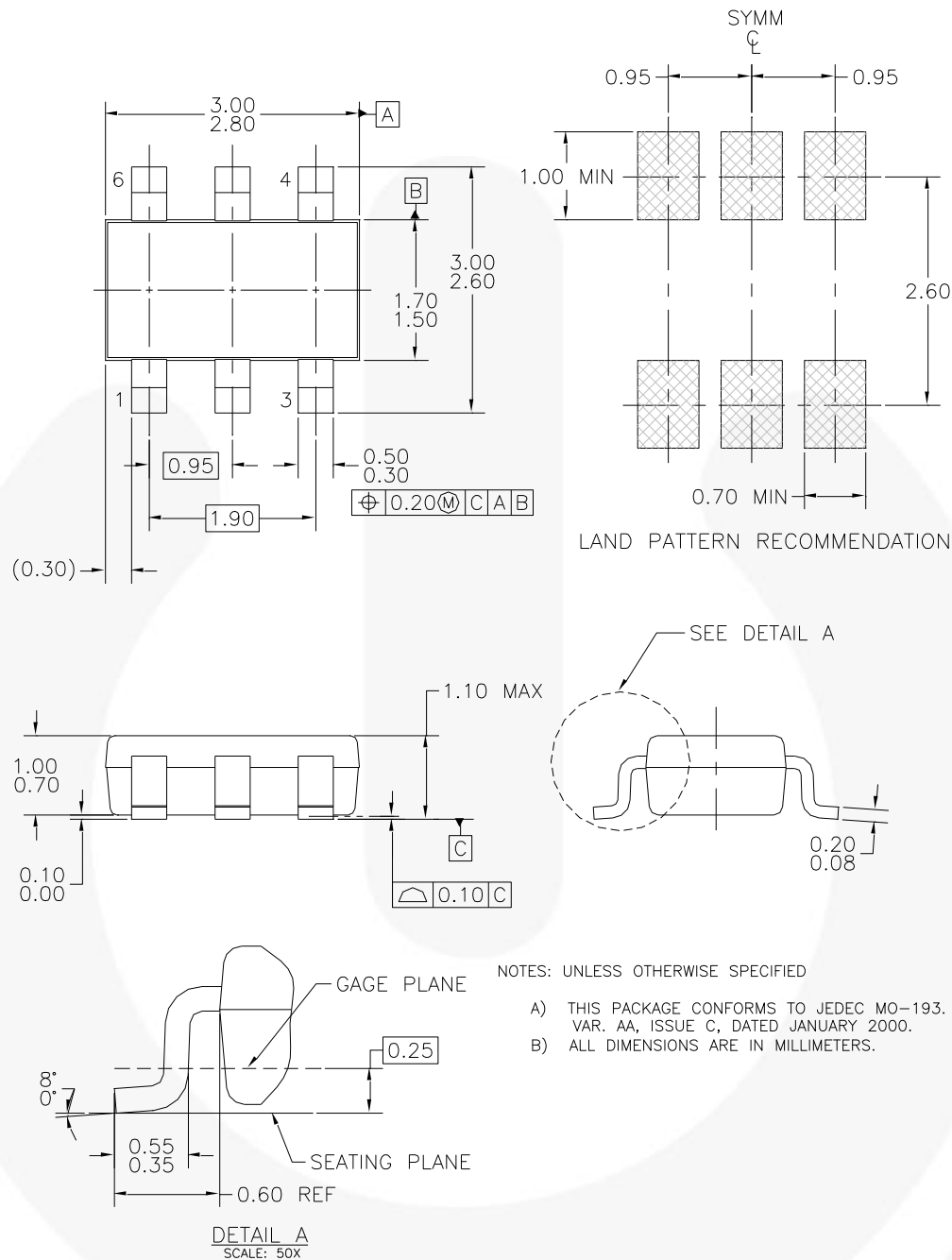

Figure 9. Typical Waveform for Grounded Neutral Detection

Physical Dimensions



MA06AREVD

Figure 10. 6-Lead SUPERSOT™







Package drawings are provided as a service to customers considering Fairchild components. Drawings may change in any manner without notice. Please note the revision and/or date on the drawing and contact a Fairchild Semiconductor representative to verify or obtain the most recent revision. Package specifications do not expand the terms of Fairchild's worldwide terms and conditions, specifically the warranty therein, which covers Fairchild products.

Always visit Fairchild Semiconductor's online packaging area for the most recent package drawings:
<http://www.fairchildsemi.com/packaging/>.



TRADEMARKS

The following includes registered and unregistered trademarks and service marks, owned by Fairchild Semiconductor and/or its global subsidiaries, and is not intended to be an exhaustive list of all such trademarks.

- | | | | |
|-----------------------------------------------------------------------------------|-----------------------------------------------------------------------------------|-----------------------------------------------------------------------------------|--------------------------------------------------------------------------------------------------------------------------------------------------------------------------------------------------------------------------------------------------------------------------------------------------------------------------------------------------------------------------------------------------------------------------------------------------------------------------------------------------------------------------------------|
| AccuPower™ | F-PFS™ | Power-SPM™ |  SYSTEM GENERAL
The Power Franchise®
 TinyBoost™
TinyBuck™
TinyCalc™
TinyLogic®
TINYOPTO™
TinyPower™
TinyPWM™
TinyWire™
TriFault Detect™
TRUECURRENT™*
μSerDes™
 UHC®
Ultra FRFET™
UniFET™
VCX™
VisualMax™
XS™ |
| Auto-SPM™ | FRFET® | PowerTrench® | |
| Build it Now™ | Global Power Resource™ | PowerXS™ | |
| CorePLUS™ | Green FPST™ | Programmable Active Droop™ | |
| CorePOWER™ | Green FPST™ e-Series™ | QFET® | |
| CROSSVOLT™ | Gmax™ | QS™ | |
| CTL™ | GTO™ | Quiet Series™ | |
| Current Transfer Logic™ | IntelliMAX™ | RapidConfigure™ | |
| DEUXPEED® | ISOPLANAR™ |  | |
| Dual Cool™ | MegaBuck™ | Saving our world, 1mW/W/kW at a time™ | |
| EcoSPARK® | MICROCOUPLER™ | SignalWise™ | |
| EfficientMax™ | MicroFET™ | SmartMax™ | |
| ESBC™ | MicroPak™ | SMART START™ | |
|  | MicroPak2™ | SPM® | |
| Fairchild® | MillerDrive™ | STEALTH™ | |
| Fairchild Semiconductor® | MotionMax™ | SuperFET™ | |
| FACT Quiet Series™ | Motion-SPM™ | SuperSOT™-3 | |
| FACT® | OptoHiT™ | SuperSOT™-6 | |
| FAST® | OPTOLOGIC® | SuperSOT™-8 | |
| FastvCore™ | OPTOPLANAR® | SupreMOS® | |
| FETBench™ |  | SyncFET™ | |
| FlashWriter®* | PDP SPM™ | Sync-Lock™ | |
| FPS™ | | | |

* Trademarks of System General Corporation, used under license by Fairchild Semiconductor.

DISCLAIMER

FAIRCHILD SEMICONDUCTOR RESERVES THE RIGHT TO MAKE CHANGES WITHOUT FURTHER NOTICE TO ANY PRODUCTS HEREIN TO IMPROVE RELIABILITY, FUNCTION, OR DESIGN. FAIRCHILD DOES NOT ASSUME ANY LIABILITY ARISING OUT OF THE APPLICATION OR USE OF ANY PRODUCT OR CIRCUIT DESCRIBED HEREIN; NEITHER DOES IT CONVEY ANY LICENSE UNDER ITS PATENT RIGHTS, NOR THE RIGHTS OF OTHERS. THESE SPECIFICATIONS DO NOT EXPAND THE TERMS OF FAIRCHILD'S WORLDWIDE TERMS AND CONDITIONS, SPECIFICALLY THE WARRANTY THEREIN, WHICH COVERS THESE PRODUCTS.

LIFE SUPPORT POLICY

FAIRCHILD'S PRODUCTS ARE NOT AUTHORIZED FOR USE AS CRITICAL COMPONENTS IN LIFE SUPPORT DEVICES OR SYSTEMS WITHOUT THE EXPRESS WRITTEN APPROVAL OF FAIRCHILD SEMICONDUCTOR CORPORATION.

As used herein:

1. Life support devices or systems are devices or systems which, (a) are intended for surgical implant into the body or (b) support or sustain life, and (c) whose failure to perform when properly used in accordance with instructions for use provided in the labeling, can be reasonably expected to result in a significant injury of the user.
2. A critical component in any component of a life support, device, or system whose failure to perform can be reasonably expected to cause the failure of the life support device or system, or to affect its safety or effectiveness.

ANTI-COUNTERFEITING POLICY

Fairchild Semiconductor Corporation's Anti-Counterfeiting Policy. Fairchild's Anti-Counterfeiting Policy is also stated on our external website, www.fairchildsemi.com, under Sales Support.

Counterfeiting of semiconductor parts is a growing problem in the industry. All manufacturers of semiconductor products are experiencing counterfeiting of their parts. Customers who inadvertently purchase counterfeit parts experience many problems such as loss of brand reputation, substandard performance, failed applications, and increased cost of production and manufacturing delays. Fairchild is taking strong measures to protect ourselves and our customers from the proliferation of counterfeit parts. Fairchild strongly encourages customers to purchase Fairchild parts either directly from Fairchild or from Authorized Fairchild Distributors who are listed by country on our web page cited above. Products customers buy either from Fairchild directly or from Authorized Fairchild Distributors are genuine parts, have full traceability, meet Fairchild's quality standards for handling and storage and provide access to Fairchild's full range of up-to-date technical and product information. Fairchild and our Authorized Distributors will stand behind all warranties and will appropriately address any warranty issues that may arise. Fairchild will not provide any warranty coverage or other assistance for parts bought from Unauthorized Sources. Fairchild is committed to combat this global problem and encourage our customers to do their part in stopping this practice by buying direct or from authorized distributors.

PRODUCT STATUS DEFINITIONS

Definition of Terms

Datasheet Identification	Product Status	Definition
Advance Information	Formative / In Design	Datasheet contains the design specifications for product development. Specifications may change in any manner without notice.
Preliminary	First Production	Datasheet contains preliminary data; supplementary data will be published at a later date. Fairchild Semiconductor reserves the right to make changes at any time without notice to improve design.
No Identification Needed	Full Production	Datasheet contains final specifications. Fairchild Semiconductor reserves the right to make changes at any time without notice to improve the design.
Obsolete	Not In Production	Datasheet contains specifications on a product that is discontinued by Fairchild Semiconductor. The datasheet is for reference information only.

Rev. 150