

1-A Dual-HBD (Dual-Half-Bridge Driver)

TLE4207G



Features

- Delivers up to 0.8 A continuous
- Optimized for DC motor management applications
- Very low current consumption in stand-by (Inhibit) mode
- Low saturation voltage; typ.1.2 V total @ 25 °C; 0.4 A
- Output protected against short circuit
- Error flag diagnosis
- Overvoltage lockout and diagnosis
- Undervoltage lockout
- CMOS/TTL compatible inputs with hysteresis
- No crossover current
- Internal clamp diodes
- Overtemperature protection with hysteresis and diagnosis
- Enhanced power PG-DSO-Package
- Green Product (RoHS compliant)
- AEC Qualified

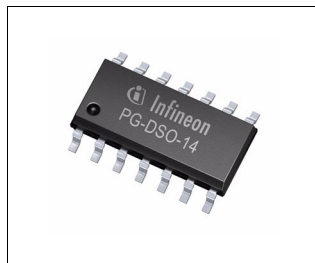

PG-DSO-14

Type	Ordering Code	Package
TLE4207G	on request	PG-DSO-14

Description

The TLE4207G is a protected **Dual-Half-Bridge-Driver** designed specially for automotive and industrial motion control applications.

The part is built using the Infineon bipolar high voltage power technology DOPL.

The actuator (DC motor) can be connected direct between the halfbridges. Operation modes forward (cw), reverse (ccw), brake and high impedance are invoked from a standard interface. The standard enhanced power PG-DSO-14 package meets the application requirements and saves PCB-board space and costs.

Furthermore the built in features like diagnosis, over- and undervoltage-lockout, short-circuit-protection, over-temperature-protection and the very low quiescent current in stand-by mode will open a wide range of automotive and industrial applications.

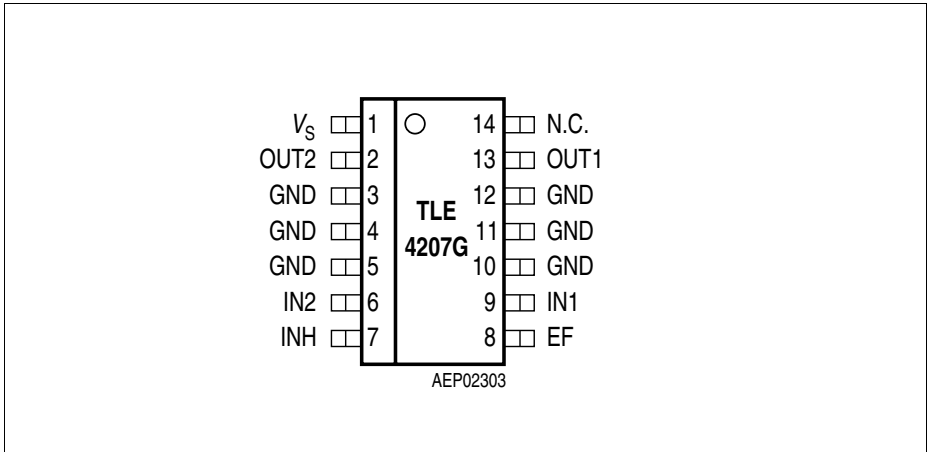

Figure 1 Pin Configuration (top view)

Pin Definitions and Functions

Pin No. PG-DSO-14	Symbol	Function
1	V_S	Power supply voltage; positive reference potential for blocking capacitor
2	OUT2	Power output 2; short circuit protected; with integrated clamp diodes
3, 4, 5, 10, 11, 12	GND	Ground; negative reference potential for blocking capacitor
6	IN2	Input channel 2; controls OUT2 (not inverted)
7	INH	Inhibit input; low = IC in stand-by
8	EF	Error Flag output; open collector; low = error
9	IN1	Input channel 1; controls OUT1 (not inverted)
13	OUT1	Power output 1; short circuit protected; with integrated clamp diodes
14	N.C.	Not connected

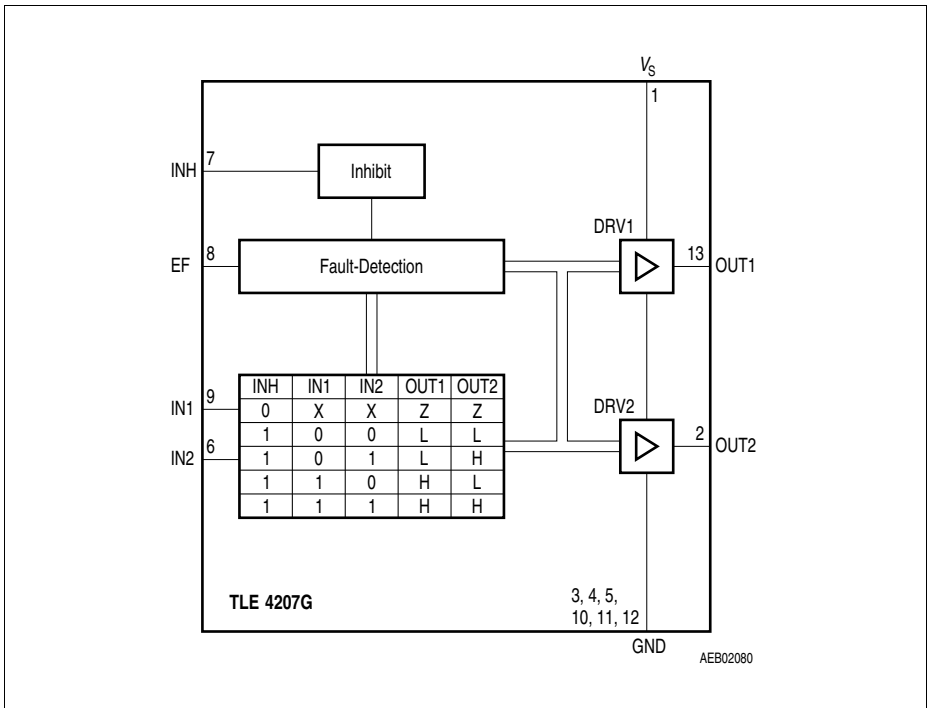

Figure 2 Block Diagram

Functional Truth Table

INH	IN1	IN2	OUT1	OUT2	Mode
0	X	X	Z	Z	Stand-By
1	0	0	L	L	Brake LL
1	0	1	L	H	CW
1	1	0	H	L	CCW
1	1	1	H	H	Brake HH

IN: 0 = Logic LOW
 1 = Logic HIGH
 X = don't care

OUT: Z = Output in tristate condition
 L = Output in sink condition
 H = Output in source condition

Diagnosis

EF	Error
1	no error
0	over temperature
0	over voltage

Electrical Characteristics
Absolute Maximum Ratings

Parameter	Symbol	Limit Values		Unit	Remarks
		min.	max.		

Voltages

Supply voltage	V_S	- 0.3	45	V	-
Supply voltage	V_S	- 1	-	V	$t < 0.5 \text{ s}; I_S > - 2 \text{ A}$
Logic input voltages (IN1; IN2; INH)	V_I	- 5	20	V	$0 \text{ V} < V_S < 45 \text{ V}$
Logic output voltage (EF)	V_{EF}	- 0.3	20	V	$0 \text{ V} < V_S < 45 \text{ V}$

Currents

Output current (cont.)	I_{OUT1-2}	-	-	A	internally limited
Output current (peak)	I_{OUT1-2}	-	-	A	internally limited
Output current (diode)	I_{OUT1-2}	- 1	1	A	-
Output current (EF)	I_{OUT1-2}	- 2	5	mA	-

Temperatures

Junction temperature	T_j	- 40	150	°C	-
Storage temperature	T_{stg}	- 50	150	°C	-

Thermal Resistances

Junction pin	$R_{thj-pin}$	-	25	K/W	measured to pin 5
Junction ambient	R_{thjA}	-	65	K/W	-

Note: Maximum ratings are absolute ratings; exceeding any one of these values may cause irreversible damage to the integrated circuit.

Operating Range

Parameter	Symbol	Limit Values		Unit	Remarks
		min.	max.		
Supply voltage	V_S	$V_{UV\ OFF}$	18	V	After V_S rising above $V_{UV\ ON}$
Supply voltage increasing	V_S	- 0.3	$V_{UV\ ON}$	V	Outputs in tristate
Supply voltage decreasing	V_S	- 0.3	$V_{UV\ OFF}$	V	Outputs in tristate
Logic input voltage (IN1; IN2; INH)	V_I	- 2	18	V	-
Junction temperature	T_j	- 40	150	°C	-

Note: In the operating range the functions given in the circuit description are fulfilled.

Electrical Characteristics

8 V < V_S < 18 V; INH = High; $I_{OUT1-2} = 0$ A; $-40\text{ °C} < T_j < 150\text{ °C}$;
 unless otherwise specified

Parameter	Symbol	Limit Values			Unit	Test Condition
		min.	typ.	max.		

Current Consumption

Quiescent current	I_S	–	20	50	μ A	INH = LOW
Quiescent current	I_S	–	20	30	μ A	INH = LOW; $V_S = 13.2$ V; $T_j = 25\text{ °C}$
Supply current	I_S	–	10	20	mA	–
Supply current	I_S	–	–	30	mA	$I_{OUT1} = 0.4$ A $I_{OUT2} = -0.4$ A
Supply current	I_S	–	–	50	mA	$I_{OUT1} = 0.8$ A $I_{OUT2} = -0.8$ A

Over- and Under Voltage Lockout

UV Switch ON voltage	$V_{UV\ ON}$	–	6.5	7.5	V	V_S increasing
UV Switch OFF voltage	$V_{UV\ OFF}$	5.0	6	–	V	V_S decreasing
UV ON/OFF hysteresis	$V_{UV\ HY}$	–	0.5	–	V	$V_{UV\ ON} - V_{UV\ OFF}$
OV Switch OFF voltage	$V_{OV\ OFF}$	–	20	24	V	V_S increasing
OV Switch ON voltage	$V_{OV\ ON}$	18.0	19.5	–	V	V_S decreasing
OV ON/OFF hysteresis	$V_{OV\ HY}$	–	0.5	–	V	$V_{OV\ OFF} - V_{OV\ ON}$

Electrical Characteristics (cont'd)

8 V < V_S < 18 V; INH = High; $I_{OUT1-2} = 0$ A; $-40\text{ °C} < T_j < 150\text{ °C}$;
 unless otherwise specified

Parameter	Symbol	Limit Values			Unit	Test Condition
		min.	typ.	max.		

Outputs OUT1-2
Saturation Voltages

Source (upper) $I_{OUT} = -0.2$ A	$V_{SAT U}$	–	0.85	1.15	V	$T_j = 25\text{ °C}$
Source (upper) $I_{OUT} = -0.4$ A	$V_{SAT U}$	–	0.90	1.20	V	$T_j = 25\text{ °C}$
Sink (upper) $I_{OUT} = -0.8$ A	$V_{SAT U}$	–	1.10	1.50	V	$T_j = 25\text{ °C}$
Sink (lower) $I_{OUT} = 0.2$ A	$V_{SAT L}$	–	0.15	0.23	V	$T_j = 25\text{ °C}$
Sink (lower) $I_{OUT} = 0.4$ A	$V_{SAT L}$	–	0.25	0.40	V	$T_j = 25\text{ °C}$
Sink (lower) $I_{OUT} = 0.8$ A	$V_{SAT L}$	–	0.45	0.75	V	$T_j = 25\text{ °C}$

Total Drop	$I_{OUT} = 0.2$ A	V_{SAT}	–	1	1.4	V	$V_{SAT} = V_{SAT U} + V_{SAT L}$
Total Drop	$I_{OUT} = 0.4$ A	V_{SAT}	–	1.2	1.7	V	$V_{SAT} = V_{SAT U} + V_{SAT L}$
Total Drop	$I_{OUT} = 0.8$ A	V_{SAT}	–	1.6	2.5	V	$V_{SAT} = V_{SAT U} + V_{SAT L}$

Clamp Diodes

Forward voltage; upper	V_{FU}	–	1	1.5	V	$I_F = 0.4$ A
Upper leakage current	$I_{L KU}$	–	–	5	mA	$I_F = 0.4$ A ¹⁾
Forward voltage; lower	V_{FL}	–	0.9	1.4	V	$I_F = 0.4$ A

Notes see page 10.

Electrical Characteristics (cont'd)

8 V < V_S < 18 V; INH = High; $I_{OUT1-2} = 0$ A; $-40\text{ °C} < T_j < 150\text{ °C}$;
 unless otherwise specified

Parameter	Symbol	Limit Values			Unit	Test Condition
		min.	typ.	max.		

Input-Interface
Logic Inputs IN1; IN2

H-input voltage	V_{IH}	–	2	3	V	–
L-input voltage	V_{IL}	1	1.5	–	V	–
Hysteresis of input voltage	$V_{IH\text{Y}}$	–	0.5	–	V	–
H-input current	I_{IH}	– 2	–	10	μA	$V_I = 5\text{ V}$
L-input current	I_{IL}	– 100	– 20	– 5	μA	$V_I = 0\text{ V}$

Logic Input INH

H-input voltage	V_{IH}	–	2.7	3.5	V	–
L-input voltage	V_{IL}	1	2	–	V	–
Hysteresis of input voltage	$V_{IH\text{Y}}$	–	0.7	–	V	–
H-input current	I_{IH}	–	100	250	μA	$V_{INH} = 5\text{ V}$
L-input current	I_{IL}	– 10	–	10	μA	$V_{INH} = 0\text{ V}$

Error-Flag EF

L-output voltage level	V_{EFL}	–	0.2	0.4	V	$I_{EF} = 2\text{ mA}$
Leakage current	I_{EFLK}	–	–	10	μA	$0\text{ V} < V_{EF} < 7\text{ V}$

Electrical Characteristics (cont'd)

8 V < V_S < 18 V; INH = High; $I_{OUT1-2} = 0$ A; $-40\text{ }^\circ\text{C} < T_j < 150\text{ }^\circ\text{C}$;
 unless otherwise specified

Parameter	Symbol	Limit Values			Unit	Test Condition
		min.	typ.	max.		

Thermal Shutdown

Thermal shutdown junction temperature	T_{jSD}	150	175	200	$^\circ\text{C}$	–
Thermal switch-on junction temperature	T_{jSO}	120	–	170	$^\circ\text{C}$	–
Temperature hysteresis	ΔT	–	30	–	K	–

1) Guaranteed by design.

Note: The listed characteristics are ensured over the operating range of the integrated circuit. Typical characteristics specify mean values expected over the production spread. If not otherwise specified, typical characteristics apply at $T_A = 25\text{ }^\circ\text{C}$ and the given supply voltage.

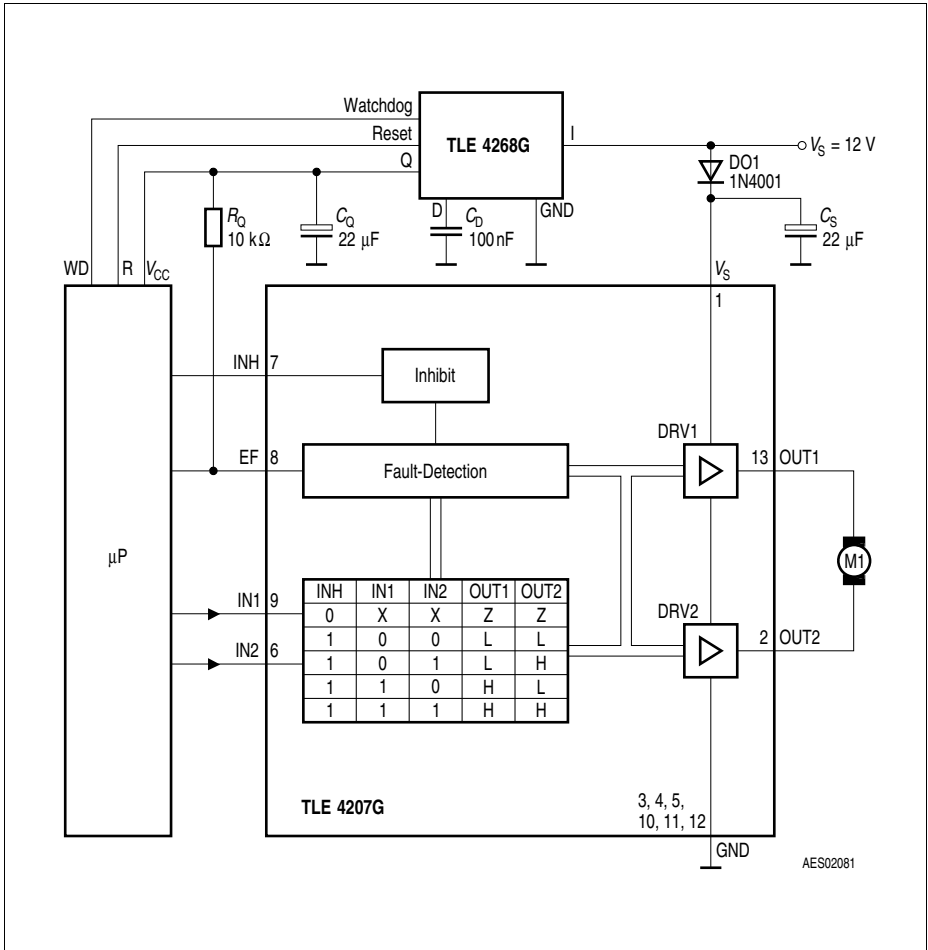
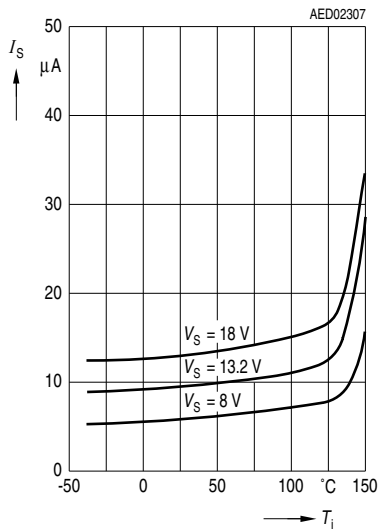

Figure 3 Application Circuit

Diagrams

Quiescent current I_S over Temperature



Saturation Voltage of Source $V_{SAT U}$ over Temperature

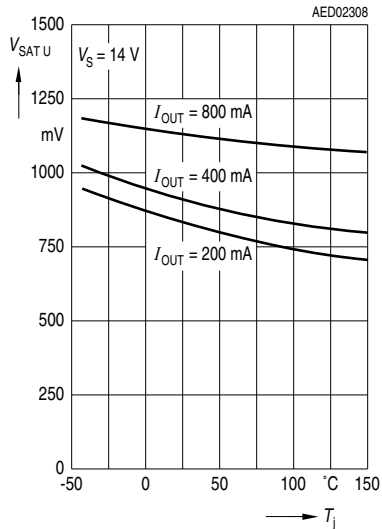

Saturation Voltage of Sink $V_{SAT L}$ over Temperature

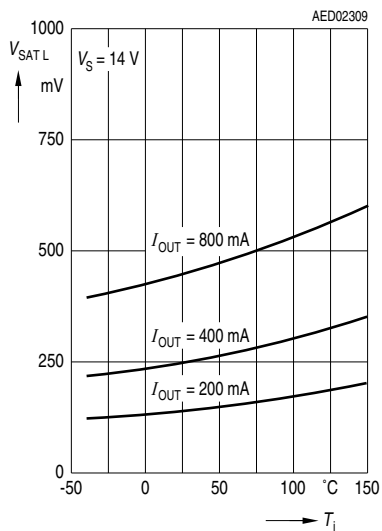

Total Drop at outputs V_{SAT} over Temperature

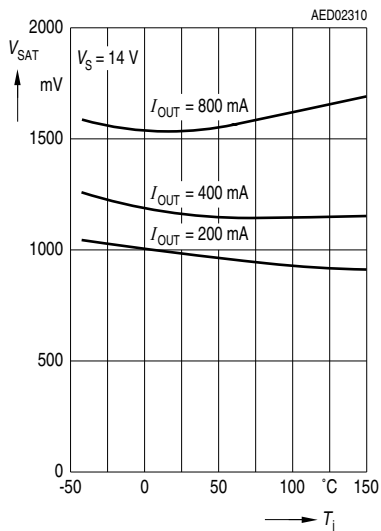

Package Outlines

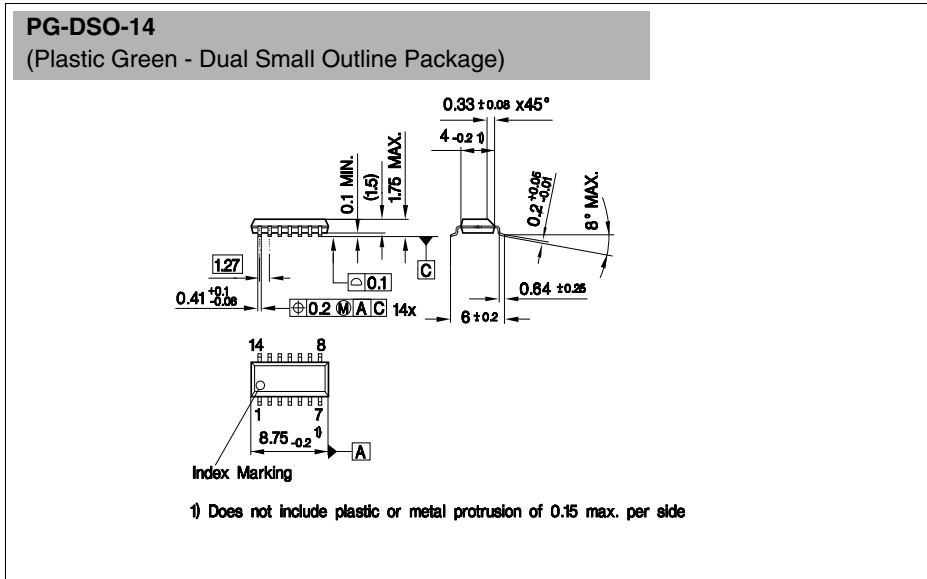

Green Product (RoHS compliant)

To meet the world-wide customer requirements for environmentally friendly products and to be compliant with government regulations the device is available as a green product. Green products are RoHS-Compliant (i.e Pb-free finish on leads and suitable for Pb-free soldering according to IPC/JEDEC J-STD-020).

Sorts of Packing

Package outlines for tubes, trays etc. are contained in our

SMD = Surface Mounted Device

Dimensions in mm

Revision History

Version	Date	Changes
Rev. 1.1	2008-01-08	Initial version of RoHS-compliant derivate of TLE4207G Page 1: added AEC certified statement Page 1 and 13: added RoHS compliance statement and Green product feature Page 1+2: Editorial change: deleted "fully" (The term "fully protected" often leads to misunderstandings as it is unclear with respect to which parameters). Page 1 and 13: Package changed to RoHS compliant version Page 14 and 15: added Revision History, updated Legal Disclaimer
Rev. 1.2	2017-05-19	Removal of package suffix: PG-DSO-14-22 replaced by PG-DSO-14

Edition 2017-05-19

**Published by
Infineon Technologies AG
81726 Munich, Germany**

**© 5/19/17 Infineon Technologies AG
All Rights Reserved.**

Legal Disclaimer

The information given in this document shall in no event be regarded as a guarantee of conditions or characteristics. With respect to any examples or hints given herein, any typical values stated herein and/or any information regarding the application of the device, Infineon Technologies hereby disclaims any and all warranties and liabilities of any kind, including without limitation, warranties of non-infringement of intellectual property rights of any third party.

Information

For further information on technology, delivery terms and conditions and prices, please contact the nearest Infineon Technologies Office (www.infineon.com).

Warnings

Due to technical requirements, components may contain dangerous substances. For information on the types in question, please contact the nearest Infineon Technologies Office.

Infineon Technologies components may be used in life-support devices or systems only with the express written approval of Infineon Technologies, if a failure of such components can reasonably be expected to cause the failure of that life-support device or system or to affect the safety or effectiveness of that device or system. Life support devices or systems are intended to be implanted in the human body or to support and/or maintain and sustain and/or protect human life. If they fail, it is reasonable to assume that the health of the user or other persons may be endangered.