



MIC5233

High Input Voltage Low IQ μ Cap LDO Regulator

General Description

The MIC5233 is a 100mA highly accurate, low dropout regulator with high input voltage and ultra-low ground current. This combination of high voltage and low ground current makes the MIC5233 ideal for multi-cell Li-Ion battery systems.

A μ Cap LDO design, the MIC5233 is stable with either ceramic or tantalum output capacitor. It only requires a 2.2 μ F capacitor for stability.

Features of the MIC5233 include enable input, thermal-shutdown, current-limit, reverse-battery protection, and reverse-leakage protection.

Available in fixed and adjustable output voltage versions, the MIC5233 is offered in the IttyBitty[®] SOT-23-5 and SOT223-3 package with a junction temperature range of -40°C to $+125^{\circ}\text{C}$.

Data sheets and support documentation can be found on Micrel's web site at: www.micrel.com.

Features

- Wide input voltage range: 2.3V to 36V
- Ultra-low ground current: 18 μ A
- Low dropout voltage of 270mV at 100mA
- High output accuracy of $\pm 2.0\%$ over temperature
- μ Cap: stable with ceramic or tantalum capacitors
- Excellent line and load regulation specifications
- Zero shutdown current
- Reverse-battery protection
- Reverse-leakage protection
- Thermal-shutdown and current-limit protection
- IttyBitty[®] SOT-23-5 and SOT-223-3 packages

Applications

- Keep-alive supply in notebook and portable computers
- USB power supply
- Logic supply for high-voltage batteries
- Automotive electronics
- Battery-powered systems
- 3 – 4 cell Li-Ion battery input range

Typical Application

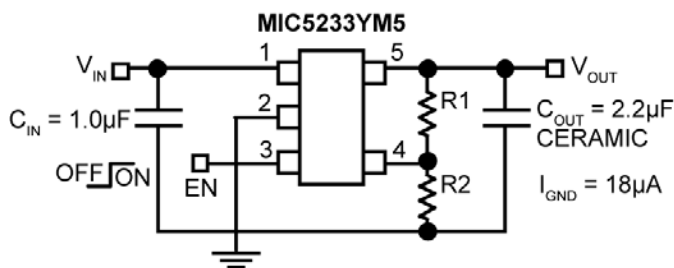

Ultra-Low Current Adjustable Regulator Application

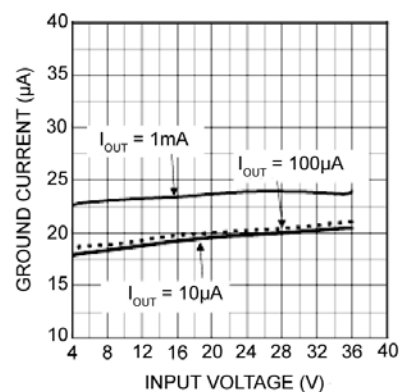

Ground Current vs. Input Voltage

IttyBitty is a registered trademark of Micrel, Inc.

Micrel Inc. • 2180 Fortune Drive • San Jose, CA 95131 • USA • tel +1 (408) 944-0800 • fax +1 (408) 474-1000 • <http://www.micrel.com>

Ordering Information

Part Number	Marking	Voltage	Junction Temperature Range ⁽¹⁾	Package
MIC5233-1.8YM5	L318	1.8V	-40°C to +125°C	SOT-23-5
MIC5233-2.5YM5	L325	2.5V	-40°C to +125°C	SOT-23-5
MIC5233-3.0YM5	L330	3.0V	-40°C to +125°C	SOT-23-5
MIC5233-3.3YM5	L333	3.3V	-40°C to +125°C	SOT-23-5
MIC5233-5.0YM5	L350	5.0V	-40°C to +125°C	SOT-23-5
MIC5233YM5	L3AA	Adjustable	-40°C to +125°C	SOT-23-5
MIC5233-3.3YS	33YS	3.3V	-40°C to +125°C	SOT-223

Note:

- Other voltages available. Contact Micrel for details.

Pin Configuration

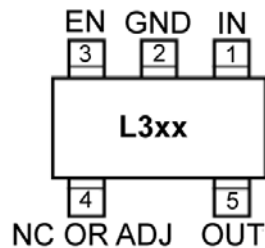

5-Pin SOT-23 (M5)

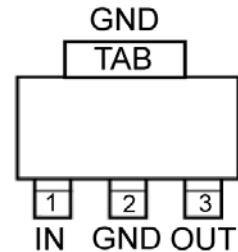

3-Pin SOT-223 (S)

Pin Description

Pin Number SOT-223	Pin Number SOT-23	Pin Name	Pin Function
1	1	IN	Supply Input.
2	2	GND	Ground.
	3	EN	Enable (Input). Logic LOW = shutdown; logic HIGH = enable.
	4	NC	No Connect.
		ADJ	Adjustable (Input). Feedback input; connect to resistive voltage-divider network.
3	5	OUT	Regulator Output.
TAB		GND	Ground.

Absolute Maximum Ratings⁽¹⁾

Input Supply Voltage (V_{IN})	-20V to +38V
Enable Input Voltage (V_{EN})	-0.3V to +38V
Power Dissipation (P_{DIS})	Internally Limited
Junction Temperature (T_J)	-40°C to +125°C
Storage Temperature (T_S)	-65°C to +150°C
ESD Rating ⁽³⁾	ESD Sensitive

Operating Ratings⁽²⁾

Input Supply Voltage (V_{IN})	+2.3V to +36V
Enable Input Voltage (V_{EN})	0V to +36V
Junction Temperature (T_J)	-40°C to +125°C
Package Thermal Resistance	
SOT-23-5 (θ_{JA})	235°C/W
SOT-223 (θ_{JA})	50°C/W

Electrical Characteristics⁽⁴⁾

$T_J = 25^\circ\text{C}$ with $V_{IN} = V_{OUT} + 1\text{V}$; $I_{OUT} = 100\mu\text{A}$; **Bold** values indicate $-40^\circ\text{C} < T_J < +125^\circ\text{C}$; unless otherwise specified.

Parameter	Condition	Min.	Typ.	Max.	Units
Output Voltage Accuracy	Variation from nominal V_{OUT}	-1.0		+1.0	%
		-2.0		+2.0	
Line Regulation	$V_{IN} = V_{OUT} + 1\text{V}$ to 36V		0.04	0.5	%
Load Regulation	$I_{OUT} = 100\mu\text{A}$ to 100mA		0.25	1	%
Dropout Voltage	$I_{OUT} = 100\mu\text{A}$		50		mV
	$I_{OUT} = 50\text{mA}$		230	300	
	$I_{OUT} = 100\text{mA}$		270	400	
Ground Current	$I_{OUT} = 100\mu\text{A}$		18	30	μA
	$I_{OUT} = 50\text{mA}$		0.25	0.70	mA
	$I_{OUT} = 100\text{mA}$		1	2	
Ground Current in Shutdown	$V_{EN} \leq 0.6\text{V}$; $V_{IN} + 36\text{V}$ (SOT-23 package only)		0.1	1	μA
Short-Circuit Current	$V_{OUT} = 0\text{V}$		190	350	mA
Output Leakage, Reverse Polarity Input	Load = 500 Ω ; $V_{IN} = -15\text{V}$		-0.1		μA
Enable Input (SOT-23 Package Only)					
Input LOW Voltage	Regulator OFF			0.6	V
Input HIGH Voltage	Regulator ON	2.0			V
Enable Input Current	$V_{EN} = 0.6\text{V}$; Regulator OFF	-1.0	0.01	1.0	μA
	$V_{EN} = 2.0\text{V}$; Regulator ON		0.1	1.0	
	$V_{EN} = 36\text{V}$; Regulator ON		0.5	2.5	
Start-Up Time	Guaranteed by design		1.7	7	ms

Notes:

- Exceeding the absolute maximum rating may damage the device.
- The device is not guaranteed to function outside its operating rating.
- Devices are ESD sensitive. Handling precautions recommended. Human body model, 1.5k Ω in series with 100pF.
- Specification for packaged product only

Typical Characteristics

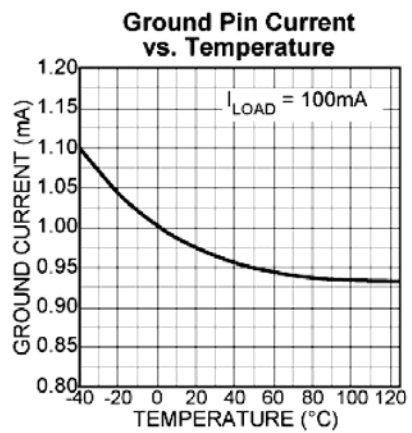
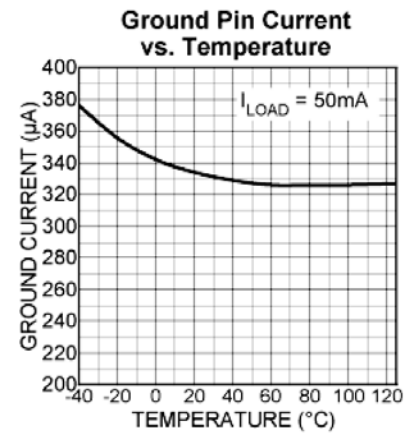
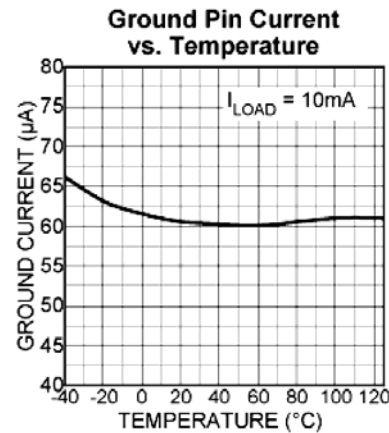
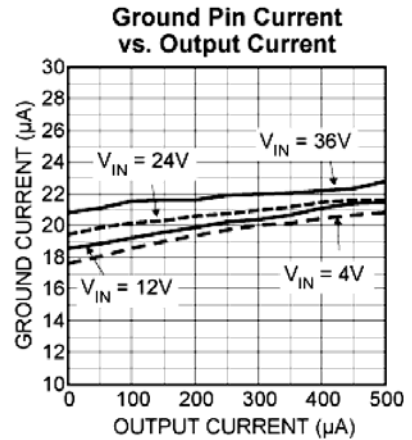
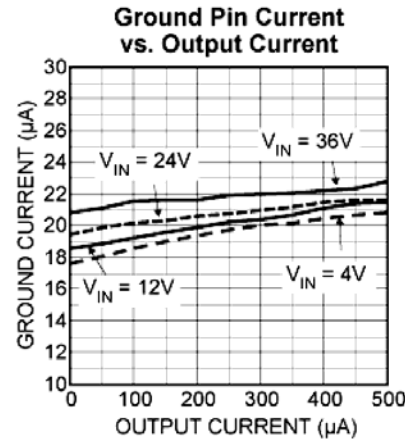
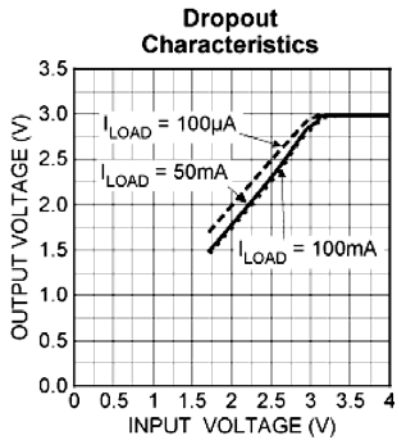
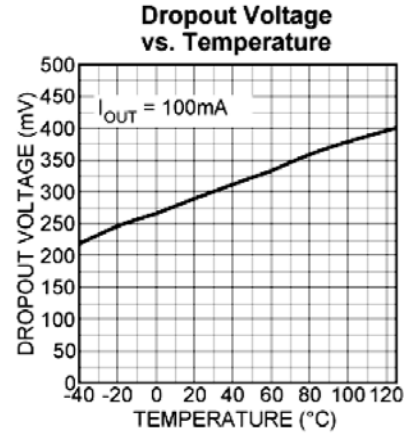
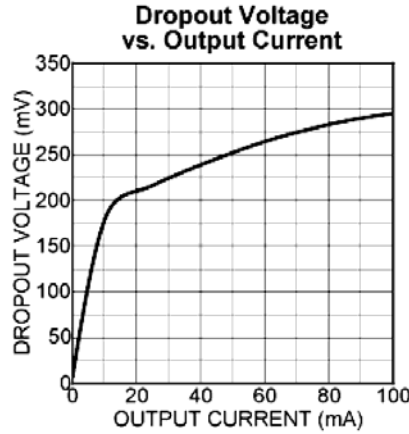
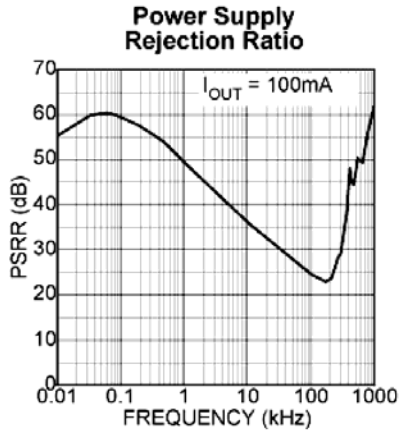

Typical Characteristics (Continued)

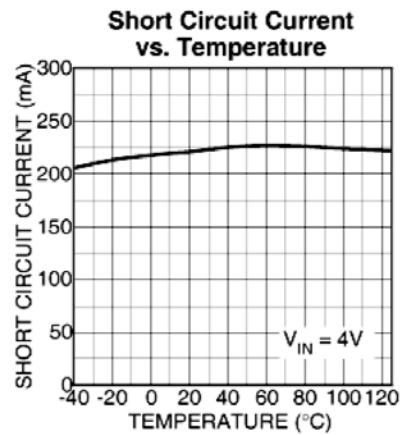
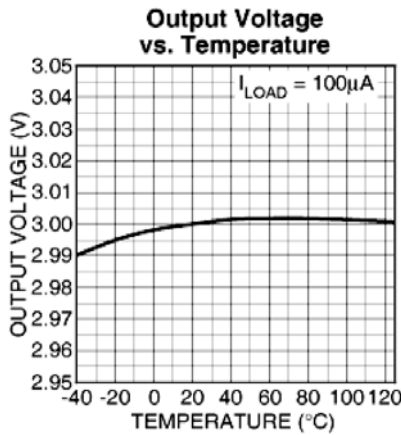
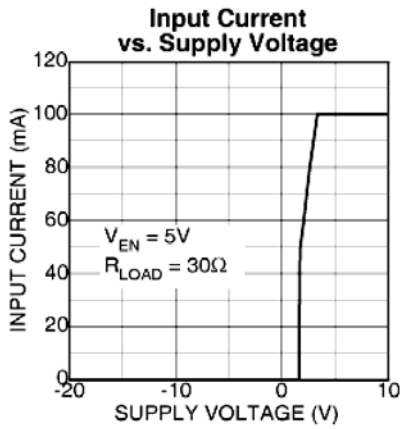
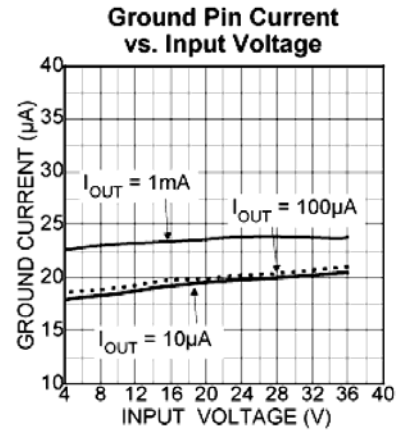
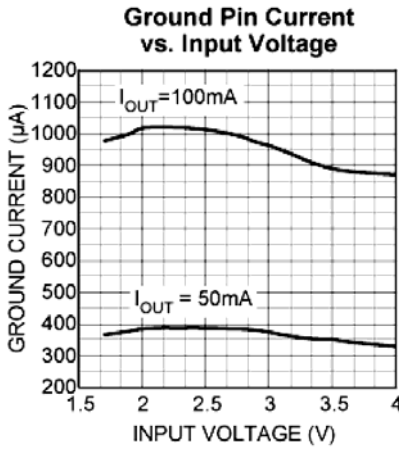
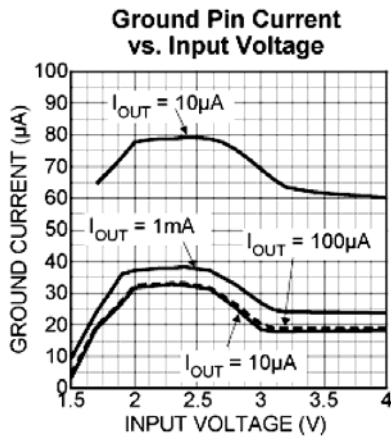

Functional Characteristics

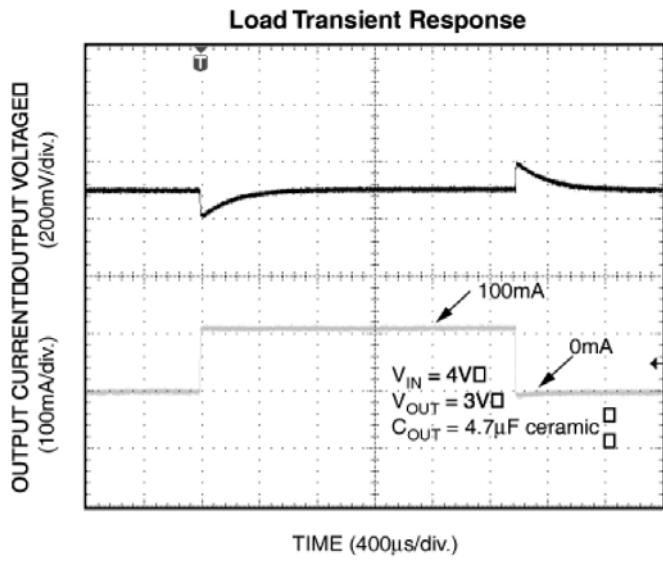

Functional Diagrams

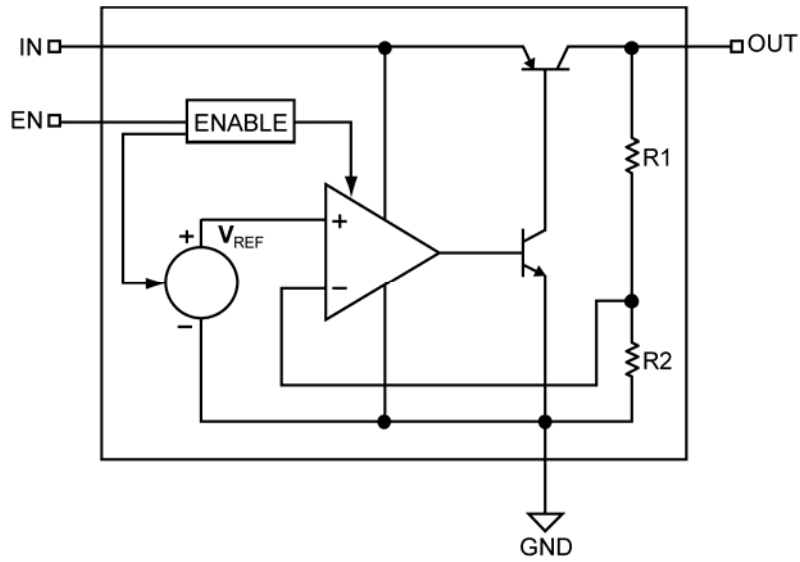

Fixed Output Voltage (M5 Package)

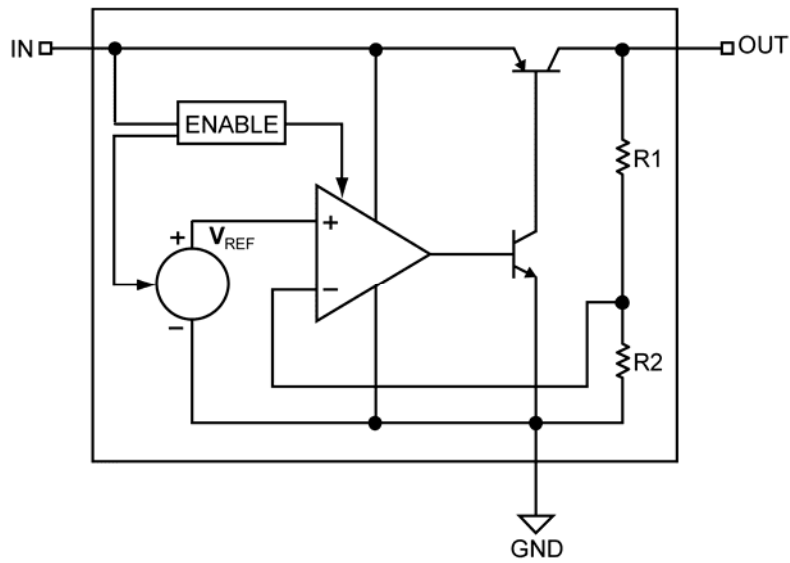

Fixed Output Voltage (S Package)

Functional Diagrams (Continued)

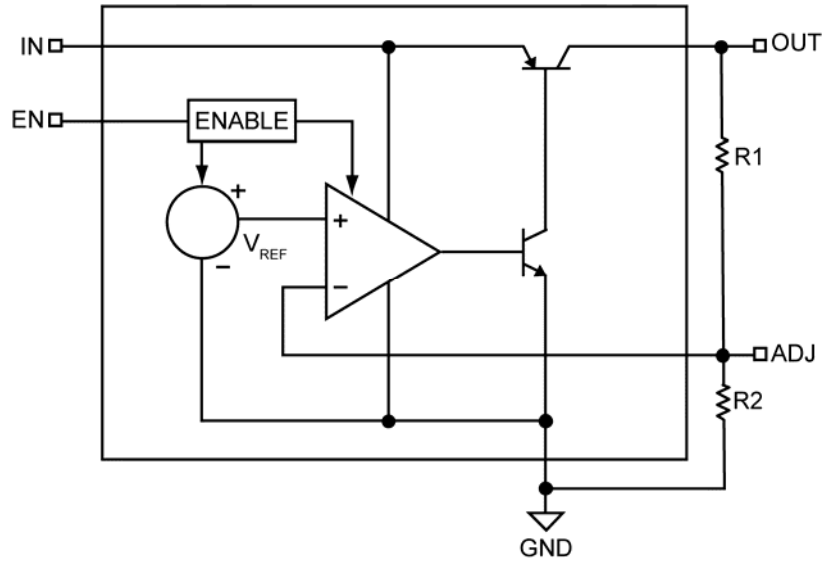

Adjustable Output Voltage

Application Information

Enable/Shutdown

The MIC5233 comes with an active-high enable pin that allows the regulator to be disabled. Forcing the enable pin low disables the regulator and sends it into a “zero” off-mode-current state. In this state, current consumed by the regulator goes nearly to zero. Forcing the enable pin high enables the output voltage.

Input Capacitor

The MIC5233 has high input voltage capability up to 36V. The input capacitor must be rated to sustain voltages that may be used on the input. An input capacitor may be required when the device is not near the source power supply or when supplied by a battery. Small, surface mount, ceramic capacitors can be used for bypassing. A larger value may be required if the source supply has high ripple.

Output Capacitor

The MIC5233 requires an output capacitor for stability. The design requires 2.2 μ F or greater on the output to maintain stability. The design is optimized for use with low-ESR ceramic chip capacitors. High-ESR capacitors may cause high-frequency oscillation. The maximum recommended ESR is 3 Ω . The output capacitor can be increased without limit. Larger valued capacitors help to improve transient response.

X7R/X5R dielectric-type ceramic capacitors are recommended because of their temperature performance. X7R-type capacitors change capacitance by 15% over their operating temperature range and are the most stable type of ceramic capacitors. Z5U and Y5V dielectric capacitors change value by as much as 50% and 60% respectively over their operating temperature ranges. To use a ceramic chip capacitor with Y5V dielectric, the value must be much higher than an X7R ceramic capacitor to ensure the same minimum capacitance over the equivalent operating temperature range.

No-Load Stability

The MIC5233 will remain stable and in regulation with no load unlike many other voltage regulators. This is especially important in CMOS RAM keep-alive applications.

Thermal Consideration

The MIC5233 is designed to provide 100mA of continuous current in a very-small package. Maximum power dissipation can be calculated based on the output current and the voltage drop across the part.

To determine the maximum power dissipation of the package, use the junction-to-ambient thermal resistance of the device and the following Equation 1:

$$P_{D(MAX)} = \left(\frac{T_{J(MAX)} - T_A}{\theta_{JA}} \right) \quad \text{Eq. 1}$$

$T_{J(MAX)}$ is the maximum junction temperature of the die, 125°C, and T_A is the ambient operating temperature. θ_{JA} is layout dependent; Table 1 shows examples of the junction-to-ambient thermal resistance for the MIC5233:

Package	θ_{JA} Recommended Minimum Footprint
SOT-23-5	235°C/W
SOT223	50°C/W

Table 1. SOT23-5 and SOT-223 Thermal Resistance

The actual power dissipation of the regulator circuit can be determined using Equation 2:

$$P_D = (V_{IN} - V_{OUT})I_{OUT} + V_{IN} \times I_{GND} \quad \text{Eq. 2}$$

Substituting $P_{D(MAX)}$ for P_D and solving for the operating conditions that are critical to the application will give the maximum operating conditions for the regulator circuit. For example, when operating the MIC5233-3.0YM5 at 50°C with a minimum footprint layout, the maximum input voltage for a set output current can be determined as follows:

$$P_{D(MAX)} = \left(\frac{125^\circ\text{C} - 50^\circ\text{C}}{235^\circ\text{C/W}} \right) \quad \text{Eq. 3}$$

where $P_{D(MAX)} = 319\text{mW}$.

The junction-to-ambient (θ_{JA}) thermal resistance for the minimum footprint is 235°C/W, from Table 1. It is important that the maximum power dissipation not be exceeded to ensure proper operation. Since the MIC5233 was designed to operate with high input voltages, careful consideration must be given so as not to overheat the device. With very high input-to-output voltage differentials, the output current is limited by the total power dissipation.

Total power dissipation is calculated using the following equation:

$$P_D = (V_{IN} - V_{OUT})I_{OUT} + V_{IN} \times I_{GND} \quad \text{Eq. 4}$$

Due to the potential for input voltages up to 36V, ground current must be taken into consideration.

If we know the maximum load current, we can solve for the maximum input voltage using the maximum power dissipation calculated for a 50°C ambient, 319mW.

$$\begin{aligned} P_{D(MAX)} &= (V_{IN} - V_{OUT})I_{OUT} + V_{IN} \times I_{GND} \\ 319\text{mW} &= (V_{IN} - 3\text{V})100\text{mA} + V_{IN} \times 2.8\text{mA} \quad \text{Eq. 5} \end{aligned}$$

Ground pin current is estimated using the typical characteristics of the device.

$$\begin{aligned} 619\text{mW} &= V_{IN} (102.8\text{mA}) \\ V_{IN} &= 6.02\text{V} \quad \text{Eq. 6} \end{aligned}$$

For higher current outputs only a lower input voltage will work for higher ambient temperatures.

Assuming a lower output current of 10mA, the maximum input voltage can be recalculated:

$$\begin{aligned} 319\text{mW} &= (V_{IN} - 3\text{V})10\text{mA} + V_{IN} \times 0.1\text{mA} \\ 349\text{mW} &= V_{IN} \times 10.1\text{mA} \\ V_{IN} &= 34.9\text{V} \quad \text{Eq. 7} \end{aligned}$$

Maximum input voltage for a 10mA load current at 50°C ambient temperature is 34.9V, utilizing virtually the entire operating voltage range of the device.

Adjustable Regulator Application

The MIC5233BM5 can be adjusted from 1.24V to 20V by using two external resistors (Figure 1). The resistors set the output voltage based on the following equation:

$$V_{OUT} = V_{REF} \left(1 + \left(\frac{R_1}{R_2} \right) \right) \quad \text{Eq. 8}$$

where $V_{REF} = 1.24\text{V}$.

Feedback resistor R2 should be no larger than 300kΩ.

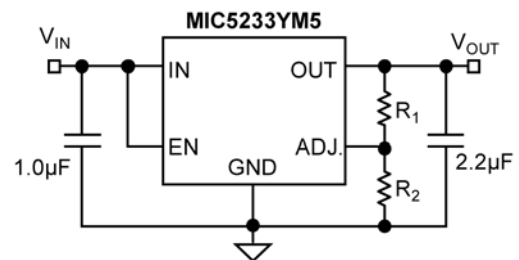
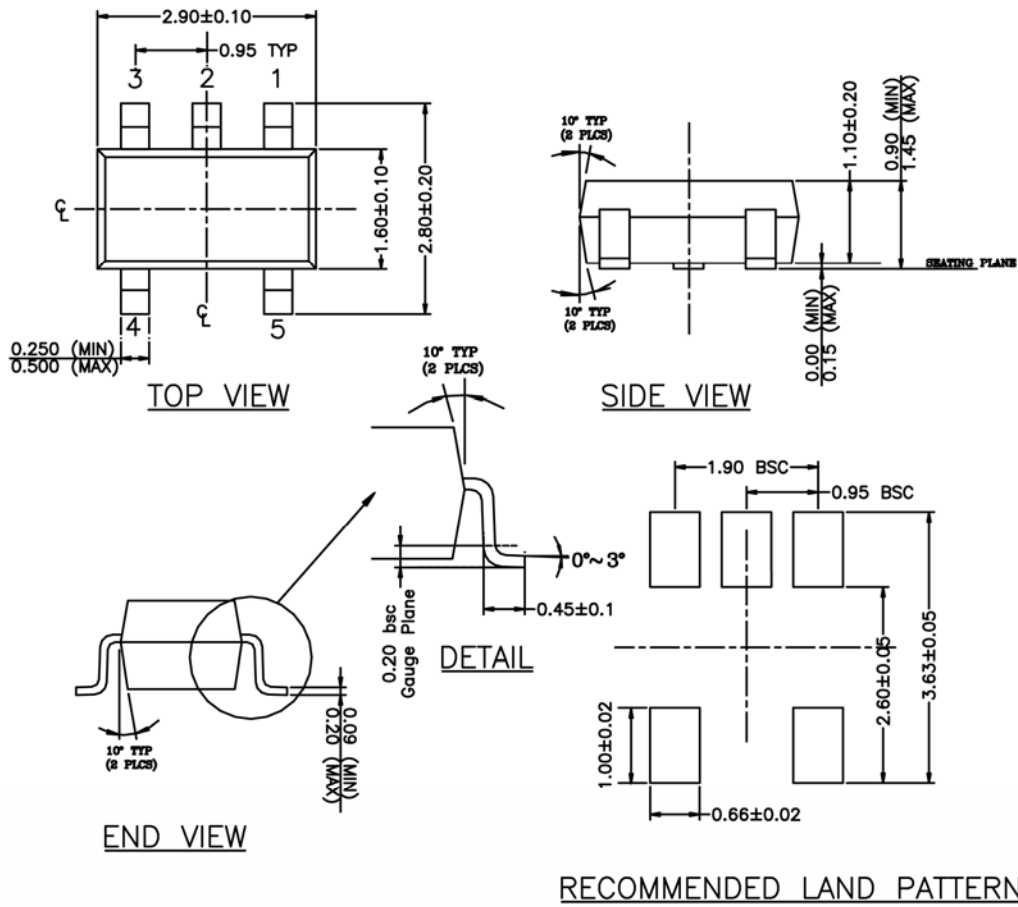

Figure 1. Adjustable Voltage Application

Package Information



- NOTE:
1. PACKAGE OUTLINE EXCLUSIVE OF MOLD FLASH & BURR.
 2. PACKAGE OUTLINE INCLUSIVE OF SOLDER PLATING.
 3. DIMENSION AND TOLERANCE PER ANSI Y14.5M, 1982.
 4. FOOT LENGTH MEASUREMENT BASED ON GAUGE PLANE METHOD.
 5. DIE FACES UP FOR MOLD, AND FACES DOWN FOR TRIM/FORM.
 6. ALL DIMENSIONS ARE IN MILLIMETERS.

5-Pin SOT-23 (M5)

Package Information (Continued)

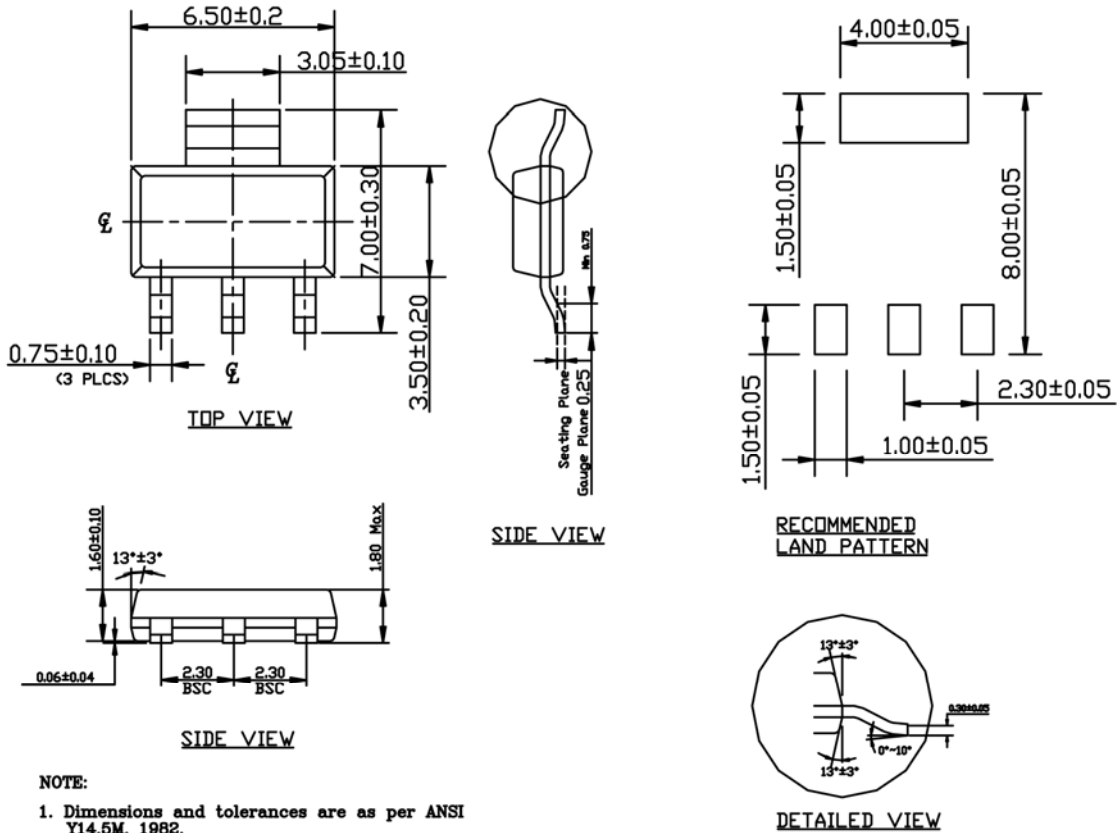

- NOTE:**
1. Dimensions and tolerances are as per ANSI Y14.5M, 1982.
 2. Controlling dimension: Millimeters.
 3. Dimensions are exclusive of mold flash and gate burr.
 4. All specification comply to Jedec spec TO261 Issue C.

3-Pin SOT-223 (S)

MICREL, INC. 2180 FORTUNE DRIVE SAN JOSE, CA 95131 USA
 TEL +1 (408) 944-0800 FAX +1 (408) 474-1000 WEB <http://www.micrel.com>

Micrel makes no representations or warranties with respect to the accuracy or completeness of the information furnished in this data sheet. This information is not intended as a warranty and Micrel does not assume responsibility for its use. Micrel reserves the right to change circuitry, specifications and descriptions at any time without notice. No license, whether express, implied, arising by estoppel or otherwise, to any intellectual property rights is granted by this document. Except as provided in Micrel's terms and conditions of sale for such products, Micrel assumes no liability whatsoever, and Micrel disclaims any express or implied warranty relating to the sale and/or use of Micrel products including liability or warranties relating to fitness for a particular purpose, merchantability, or infringement of any patent, copyright or other intellectual property right.

Micrel Products are not designed or authorized for use as components in life support appliances, devices or systems where malfunction of a product can reasonably be expected to result in personal injury. Life support devices or systems are devices or systems that (a) are intended for surgical implant into the body or (b) support or sustain life, and whose failure to perform can be reasonably expected to result in a significant injury to the user. A Purchaser's use or sale of Micrel Products for use in life support appliances, devices or systems is a Purchaser's own risk and Purchaser agrees to fully indemnify Micrel for any damages resulting from such use or sale.

© 2003 Micrel, Incorporated.