

DATA SHEET

TEA6850

**IF filter / amplifier / demodulator for
FM radio receivers**

Preliminary specification
File under Integrated Circuits, IC01

July 1994

IF filter / amplifier / demodulator for FM radio receivers

TEA6850

FEATURES

- Improved dynamic selectivity and sensitivity because of tunable IF filter
- Fully integrated, frequency matched FM demodulator
- High linearity
- Unweighted level detector output
- Soft mute
- MPX output for RDS and diversity
- Internal source selector.

GENERAL DESCRIPTION

The TEA6850 is a monolithic bipolar integrated circuit for IF filtering, FM demodulation and level detection. Using IF filters tuned by the demodulated signal, dynamic selectivity and sensitivity are improved.

QUICK REFERENCE DATA

SYMBOL	PARAMETER	MIN.	TYP.	MAX.	UNIT
V_P	supply voltage (pin 7)	7	8.5	10	V
I_P	supply current (pin 7)	14	17.5	21	mA
DS200	dynamic selectivity for 200 kHz distance (EMF = 700 μ V; filter bandwidth = 50 kHz)	22	27	–	dB
S/N	signal-to-noise ratio ($\Delta f = \pm 22.5$ kHz; $f_m = 1$ kHz)	61	67	–	dB
THD	total harmonic distortion ($\Delta f = \pm 75$ kHz; $f_m = 1$ kHz)	–	0.3	0.5	%
V_O	AF output signal at pin 4 (RMS value)	180	200	220	mV
T_{amb}	operating ambient temperature	–40	–	+85	$^{\circ}$ C

ORDERING INFORMATION

EXTENDED TYPE NUMBER	PACKAGE			
	PINS	PIN POSITION	MATERIAL	CODE
TEA6850H	44	QFP	plastic	SOT307 ⁽¹⁾

Note

1. SOT307-2; 1996 August 26.

IF filter / amplifier / demodulator for FM
radio receivers

TEA6850

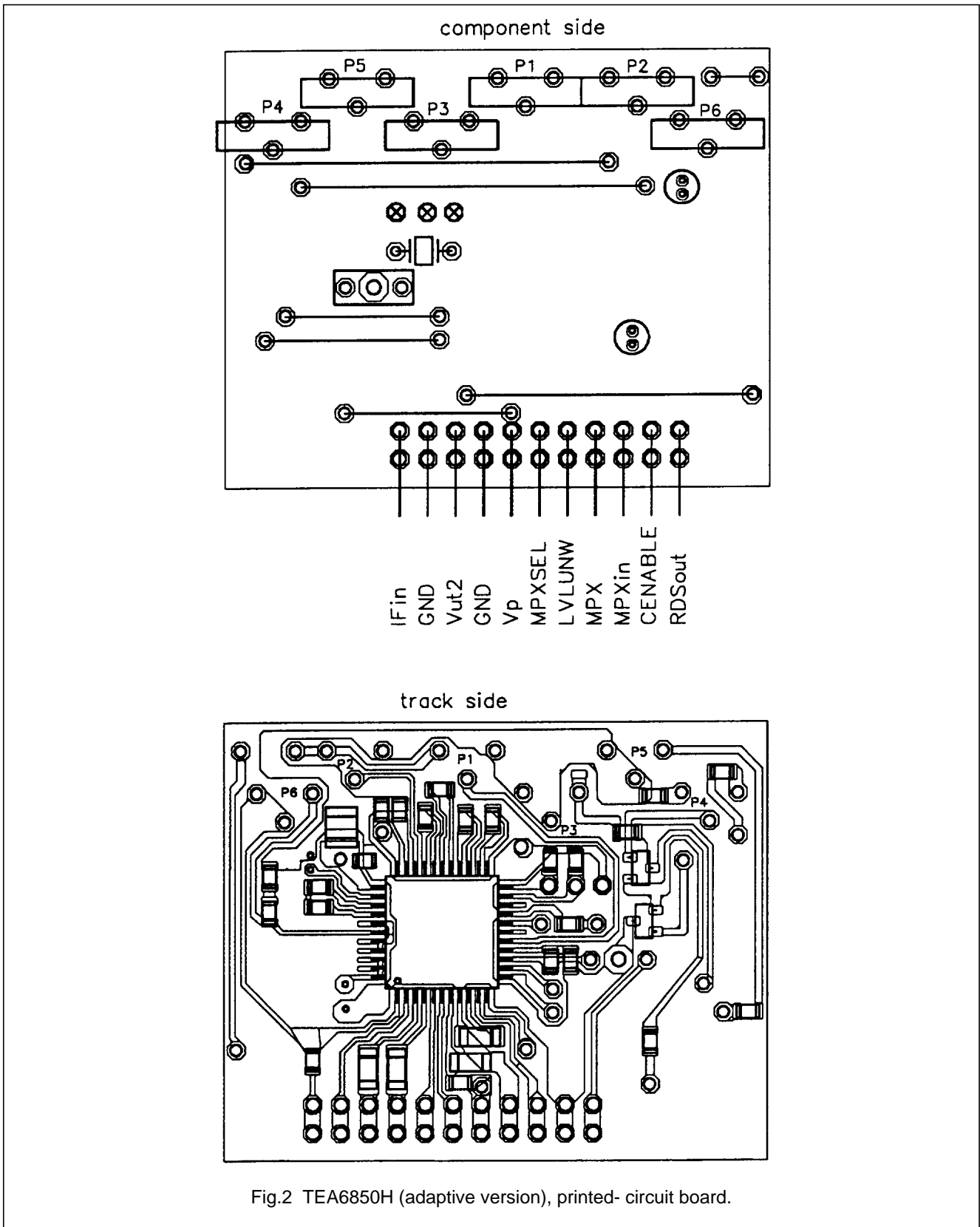

Fig.2 TEA6850H (adaptive version), printed- circuit board.

IF filter / amplifier / demodulator for FM radio receivers

TEA6850

PINNING

SYMBOL	PIN	DESCRIPTION
RDS _{OUT}	1	output for RDS
CENABLE	2	chip enable
MPX _{IN}	3	external audio frequency input (MPX signal)
MPX	4	audio frequency output (MPX signal)
LVLUNW	5	unweighted level output
MPXSEL	6	source selector for MPX signal
V _P	7	supply voltage (8.5 V)
GND	8	ground (0 V)
V _{GAP}	9	internal reference voltage
V _{UT2}	10	reference voltage output
V _{UT1}	11	reference voltage output
IFADJ	12	input for IF filter frequency adjustment
BWADJ	13	input for IF filter bandwidth adjustment
IF _{IN}	14	IF signal input 1
IF _{IN2}	15	IF signal input 2
GAINADJ	16	input for mixer gain adjustment
n.c.	17	not connected
CRYSTAL	18	crystal oscillator input
GND	19	oscillator ground
n.c.	20	not connected
OUT300I	21	IF filter output (0°)
OUT300Q	22	IF filter output (90°)
CLIM1I	23	IF limiter feedback 1
CLIM2I	24	IF limiter feedback 2
CLIM3I	25	IF limiter feedback 3
CLIM4I	26	IF limiter feedback 4
CLIM1Q	27	IF limiter feedback 5
CLIM2Q	28	IF limiter feedback 6
CLIM3Q	29	IF limiter feedback 7
CLIM4Q	30	IF limiter feedback 8
LVLADJ	31	input for level adjustment
LVLWEI	32	weighted level output
IHP60	33	input for high-pass -3 dB adjustment
CHPMUTE	34	output of rectified high-pass signal
CMUTE	35	mute input
DEMOLOOP1	36	demodulator output 1
DEMOLOOP2	37	demodulator output 2
COP2	38	MPX correction output 2
CON2	39	MPX correction input 2
COO1	40	MPX correction output 1

IF filter / amplifier / demodulator for FM
radio receivers

TEA6850

SYMBOL	PIN	DESCRIPTION
CON1	41	MPX correction input 1
IFLOOP1	42	IF loop filter output 1
IFLOOP2	43	IF loop filter output 2
IFLOOP3	44	IF loop filter output 3

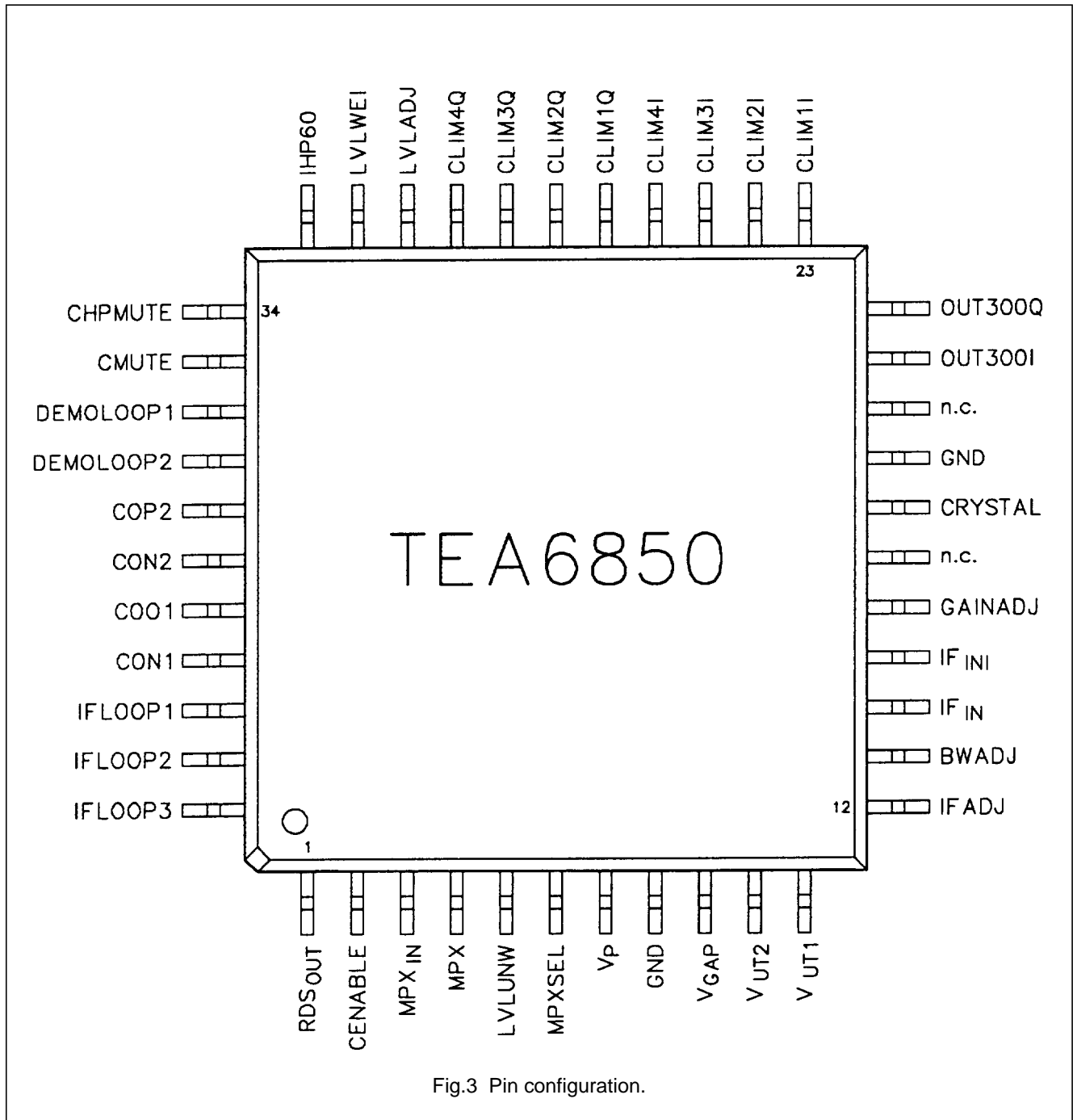

IF filter / amplifier / demodulator for FM radio receivers

TEA6850

FUNCTIONAL DESCRIPTION

The first mixer stage at the input of the circuit is for mixing the 10.7 MHz IF signal to 300 kHz. The IF filter has a resonance frequency of 300 kHz (adjustable), tunable from 50 kHz to 500 kHz, and a bandwidth of about 20 kHz to 80 kHz tunable. Static filter response see Fig.5. The limiter has a gain of approximately 90 dB, which is virtually independent from temperature change. The demodulator is frequency matched with the IF filter.

LIMITING VALUES

In accordance with the Absolute Maximum Rating System (IEC 134).

SYMBOL	PARAMETER	MIN.	MAX.	UNIT
V_P	supply voltage	-0.3	+12	V
I_P	supply current	-	21	mA
T_{stg}	storage temperature	-55	+125	°C
T_{amb}	operating ambient temperature	-40	+85	°C
P_{tot}	total power dissipation	-	252	mW
V_{ESD}	electrostatic handling for all pins (note 1)	-	±300	V

Note to the Limiting Values

1. Charge device model class B: equivalent to discharging a 200 pF capacitor through a 0 Ω series resistor.

THERMAL RESISTANCE

SYMBOL	PARAMETER	THERMAL RESISTANCE
$R_{th\ j-a}$	from junction to ambient in free air	65 K/W

IF filter / amplifier / demodulator for FM radio receivers

TEA6850

DC CHARACTERISTICS

$V_P = 8.5 \text{ V}$; $T_{\text{amb}} = +25 \text{ }^\circ\text{C}$; all voltages referenced to ground unless otherwise specified.

SYMBOL	PARAMETER	MIN.	TYP.	MAX.	UNIT
V_P	supply voltage	7	8.5	10	V
I_P	supply current (TEA6850 enable)	14	17.5	21	mA
I_P	supply current (TEA6850 disable)	320	400	480	μA
V_1	voltage at pin 1	2.1	2.4	2.7	V
V_2	voltage at pin 2	tbn	tbn	tbn	V
V_3	voltage at pin 3	3.3	3.55	3.8	V
V_4	voltage at pin 4	3.3	3.55	3.8	V
V_5	voltage at pin 5	tbn	tbn	tbn	V
V_6	voltage at pin 6	2.1	2.3	2.5	V
V_{12}	voltage at pin 12	0.98	1.08	1.18	V
V_{13}	voltage at pin 13	tbn	tbn	tbn	V
V_{14}	voltage at pin 14	1.8	2	2.2	V
V_{15}	voltage at pin 15	1.8	2	2.2	V
V_{16}	voltage at pin 16	tbn	tbn	tbn	V
V_{18}	voltage at pin 18	3.0	3.3	3.6	V
V_{21}	voltage at pin 21	3.2	3.5	3.8	V
V_{22}	voltage at pin 22	3.2	3.5	3.8	V
V_{23}	voltage at pin 23	3.9	4.2	4.5	V
V_{24}	voltage at pin 24	3.9	4.2	4.5	V
V_{25}	voltage at pin 25	3.9	4.2	4.5	V
V_{26}	voltage at pin 26	3.9	4.2	4.5	V
V_{27}	voltage at pin 27	3.9	4.2	4.5	V
V_{28}	voltage at pin 28	3.9	4.2	4.5	V
V_{29}	voltage at pin 29	3.9	4.2	4.5	V
V_{30}	voltage at pin 30	3.9	4.2	4.5	V
V_{31}	voltage at pin 31	tbn	tbn	tbn	V
V_{32}	voltage at pin 32	tbn	tbn	tbn	V
V_{33}	voltage at pin 33	4.1	4.4	4.7	V
V_{34}	voltage at pin 34	2.7	2.9	3.3	V
V_{35}	voltage at pin 35	2.1	2.4	2.7	V
V_{36}	voltage at pin 36	4.2	4.4	4.6	V
V_{37}	voltage at pin 37	4.2	4.4	4.6	V
V_{38}	voltage at pin 38	2.1	2.4	2.7	V
V_{39}	voltage at pin 39	2.1	2.4	2.7	V
V_{40}	voltage at pin 40	2.1	2.4	2.7	V
V_{41}	voltage at pin 41	2.1	2.4	2.7	V
V_{42}	voltage at pin 42	1.6	1.75	1.9	V
V_{43}	voltage at pin 43	1.6	1.75	1.9	V
V_{44}	voltage at pin 44	1.6	1.75	1.9	V

IF filter / amplifier / demodulator for FM radio receivers

TEA6850

SYMBOL	PARAMETER	MIN.	TYP.	MAX.	UNIT
Reference voltage source					
V ₉	voltage at pin 9	2.4	2.55	2.7	V
V ₁₀	voltage at pin 10	2.95	3.25	3.55	V
V ₁₁	voltage at pin 11	0.98	1.08	1.2	V
TK	temperature coefficient of V ₁₀ and V ₁₁	–	3.3	–	10 ⁻³ /K

AC CHARACTERISTICS

V_P = 8.5 V; T_{amb} = +25 °C; f = 10.7 MHz with f_m = 1 kHz, ±22.5 kHz deviation (Δf = ±22.5 kHz); EMF = 30 mV RMS; 50 μs de-emphasis; filter bandwidth = 50 kHz overall; –6 dB gain from EMF to IF filter output (pins 21 and 22); in noise frequency band for S/N measurements 300 Hz to 15 kHz; S/N stereo measurement with ideal decoder; measurements taken in Fig.4 unless otherwise specified.

SYMBOL	PARAMETER	CONDITIONS	MIN.	TYP.	MAX.	UNIT
DS100	dynamic selectivity for 100 kHz distance	EMF = 700 μV	13	16	–	dB
		EMF = 14 mV	10	12	–	dB
DS200	dynamic selectivity for 200 kHz distance	EMF = 700 μV	22	27	–	dB
		EMF = 14 mV	18	22	–	dB
S/N	signal-to-noise ratio	mono	61	67	–	dB
		stereo	54	57	–	dB
EMF	IF signal	S/N = 26 dB; V ₅ = 5 V	–	20	45	μV
		S/N = 46 dB; V ₅ = 5 V	–	130	370	μV
EMF	input voltage for start of limiting (RMS value)	–3 dB at MPX output; V ₅ = 5V	–	10	20	μV
THD	total harmonic distortion	Δf = 75 kHz	–	0.3	0.5	%
		Δf = 100 kHz	–	0.5	1	%
		f _m = 8 kHz; Δf = 75 kHz	–	3	5	%
D ₅₇	attenuation of third harmonic measured at pin 4	f _m = 19 kHz; Δf = 6.75 kHz; measured at 57 kHz compared to 57 kHz Δf = 2 kHz	14	20	–	dB
EMF	admissible maximum input voltage (RMS value)		300	–	–	mV
A _{14-21,22}	gain to IF filter output (adjustable)		–	–6	–	dB
ΔA _{DC}	downconverter adjustable range		–10	–	+6	dB
V _O	MPX output voltage (RMS value)		180	200	220	mV
ΔV _O	MPX output voltage ripple	1 kHz < f _{mod} < 15 kHz	–	–	±2	dB
		23 kHz < f _{mod} < 53 kHz	–	–	±2	dB

IF filter / amplifier / demodulator for FM radio receivers

TEA6850

SYMBOL	PARAMETER	CONDITIONS	MIN.	TYP.	MAX.	UNIT
RR	power supply ripple rejection	$f = 200 \text{ Hz to } 20 \text{ kHz};$ $V_{rmax} = 100 \text{ mV (on } V_P);$ ripple at MPX output	38	–	–	dB
α_{AM}	AM suppression	$f_{mod} = 400 \text{ Hz};$ modulation = 30%	–	50	–	dB
		$500 \mu\text{V} < \text{EMF} < 100 \text{ mV}$	40	44	–	dB
RDS output (pin 1)						
Z_O	output impedance		–	–	1	k Ω
R_L	load resistance		15	–	–	k Ω
C_L	load capacitance		–	–	50	pF
V_1	RDS signal output voltage	$f_{mod} = 57 \text{ kHz}; \Delta f = 2 \text{ kHz};$ $R_L = \infty; C_L = 0$	4	6	–	mV
t_{switch}	switch on time		–	–	500	ms
10.7 MHz input (pins 14 and 15)						
R_i	input resistance		3.5	5	6.5	k Ω
C_i	input capacitance		–	–	5	pF
V_{14}	residual oscillator signal	$f_{osc}/2 = 11 \text{ mHz}; R_G = 300 \Omega$	–	–	30	μV
Crystal						
f_0	standard frequency		–	22	–	MHz
$\Delta f_0/f_0$	frequency tolerance		–100	–	+100	ppm
C_0	shunt capacitance		–	–	7	pF
R_S	equivalent series resistance		–	–	120	Ω
$\Delta T_0/T_0$	temperature drift	$-40 \text{ }^\circ\text{C} < T < +85 \text{ }^\circ\text{C}$	–50	–	+50	ppm
Oscillator (measured at pin 18)						
V_{18}	22 MHz output level		13	20	40	mV
OUT300Q, I output (pins 21 and 22; $R_{OUT300} = 33 \text{ k}\Omega$; see Fig.4)						
$V_{21,22}$	output voltage	EMF = 75 mV	7	12	14	mV
$ V_{21} - V_{22} $	I, Q output level difference		–	–	1.5	mV
TC	temperature coefficient of output voltage		–	3.3	–	$10^{-3}/\text{K}$
Z_O	output impedance		–	1.26	–	k Ω
Turnable filter ($-40 \text{ }^\circ\text{C} < T < +85 \text{ }^\circ\text{C}$; filter response see Fig.5)						
ΔF_0	frequency temperature shift		–10	0	+10	kHz
ΔB	bandwidth temperature shift		–5	0	+3	kHz
B_{max}	maximum adjustable bandwidth	$V_{13} = 0 \text{ V}$	70	80	–	kHz
B_{min}	minimum adjustable bandwidth		–	20	–	kHz

IF filter / amplifier / demodulator for FM radio receivers

TEA6850

SYMBOL	PARAMETER	CONDITIONS	MIN.	TYP.	MAX.	UNIT
Level amplifier (pin 5; typical curve and adjusting range see Fig.7)						
Z _O	output impedance		8	10	12	kΩ
TC	temperature coefficient of output voltage		–	3.3	–	10 ⁻³ /K
V ₅	output voltage	α = –3 dB for EMF = 200 μV; EMF = 100 μV	2.1	2.35	2.6	V
		EMF = 1 mV	2.95	3.3	3.65	V
S	slope of output voltage	100 μV < EMF < 10 mV	–	950	–	mV/20 dB
V ₅	level shift adjustment range	EMF = 0	±0.5	±1.0	±1.5	V
Soft mute (typical curves see Fig.8)						
level dependence						
EMF	start of mute (α = –3 dB) for IF input (RMS value)		–	200	–	μV
EMF	–3 dB adjustment range for IF input		100	–	300	μV
S _M	mute slope at –15 dB		29	32	35	dB/Dec
V _{MPX} /V _{MPX0}	muting depth	EMF < 5 μV; α = –3 dB for EMF = 200 μV	–35	–32	–29	dB
I ₃₂	charge current	V ₅ = 4.5 V; V ₃₂ = 3.9 V	10	13	17	μA
	discharge current	V ₅ = 4.5 V; V ₃₂ = 5.1 V	20	26	34	μA
τ _{mute}	time constant from unmuted to muted		0.75	1	1.3	ms
τ _{unmute}	time constant from muted to unmuted		1.5	2	2.6	ms
high-pass dependence (see Fig.9)						
V _{MPX} /V _{MPX0}	muting depth		–12	–10	–8	dB
V ₁	voltage at pin 1 (RMS value)	f = 60 kHz; V _{MPX} /V _{MPX0} = –3 dB	165	185	205	mV
I ₃₄	charge current	V ₃₄ = 0 V	140	200	260	μA
	discharge current	V ₃₄ = 5 V	0.7	1	3	μA
ΔV ₄	residual DC offset at MPX output	EMF < 80 μV	–	–	60	mV
		80 μV < EMF < 2 mV	–	–	60	mV
MPX output (pin 4)						
R _O	output resistance		–	–	100	Ω
R _L	load resistance	V ₄ ≤ 1 V	3	–	–	kΩ
C _L	load capacitance		–	–	50	pF
V ₄	clipping DC voltage		1.5	–	7	V
V ₄	residual signal of 300 kHz and higher harmonics (RMS value)		–	–	10	mV

IF filter / amplifier / demodulator for FM
radio receivers

TEA6850

SYMBOL	PARAMETER	CONDITIONS	MIN.	TYP.	MAX.	UNIT
CENABLE (pin 2)						
V ₂	voltage range	chip enable	-0.3	+0.6	+1.1	V
		chip disable	1.9	2.4	5.5	V
R _I	input resistance		100	-	-	kΩ
Source selector isolation (f < 12.5 kHz; mode TEA6850 signal: V ₆ > 1.9 V or pin not connected; mode external signal: V ₆ < 1.1 V)						
V _{MPX} /V _{MPXIN}	isolation of external signal	mode TEA6850 signal; Δf = 0; V _{MPXIN} = 200 mV; f = 12.5 kHz	-70	-80	-	dB
V _{MPX} /V _{MPX0}	isolation of TEA6850 signal	mode external signal; Δf = 22.5 kHz; R _g (pin 3) < 10 kΩ; f _{mod} = 12.5 kHz	-70	-80	-	dB
R _I	input resistance at pin 6	V ₆ > 1.9 V	1	-	-	MΩ
		V ₆ < 1.1 V	3	-	-	kΩ
	input resistance at pin 3		23	30	37	kΩ
I ₆	input current	V _{sselect} < 1.1 V	-	-	20	μA

IF filter / amplifier / demodulator for FM
radio receivers

TEA6850

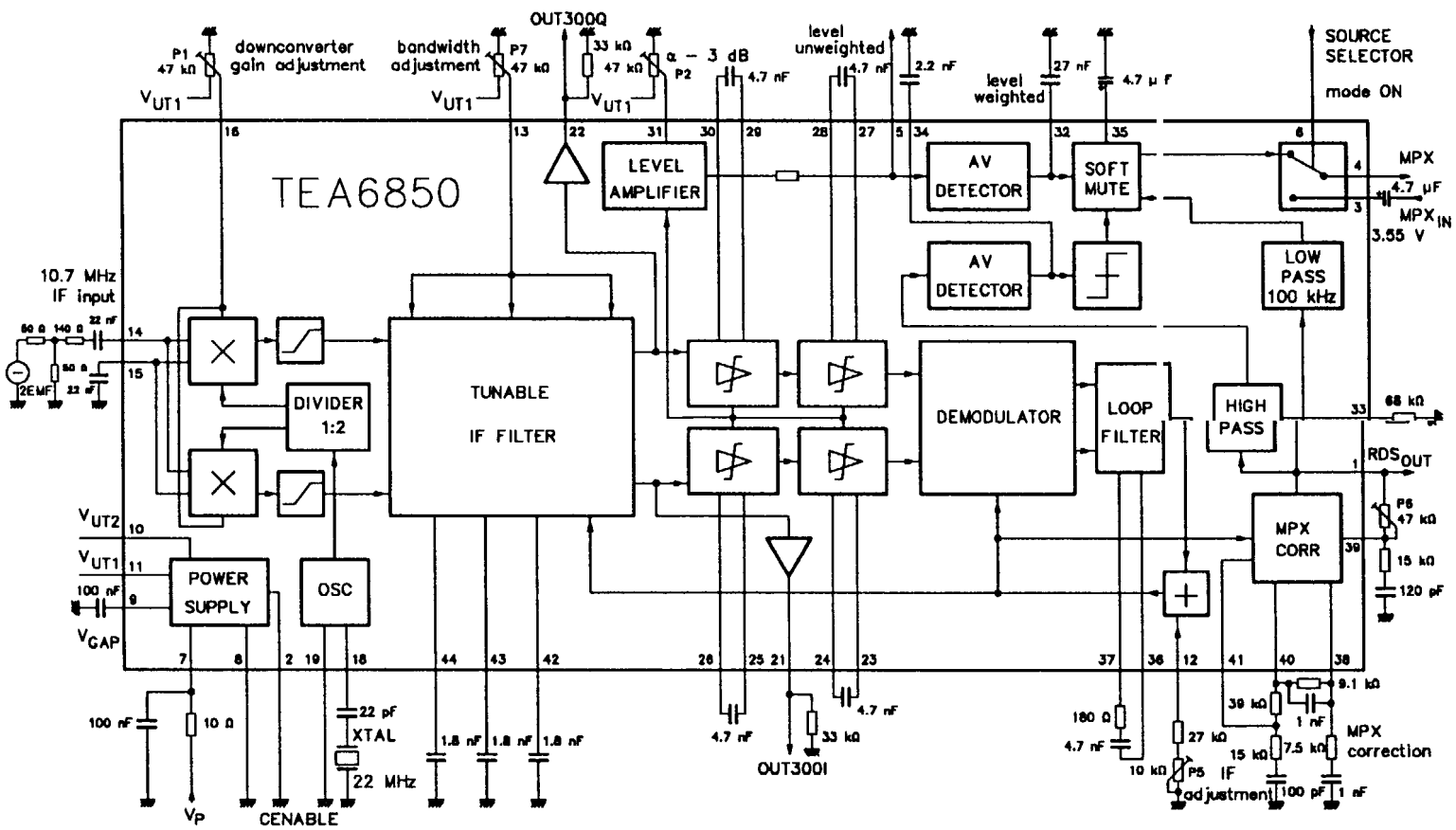

Fig.4 Test circuit.

IF filter / amplifier / demodulator for FM
radio receivers

TEA6850

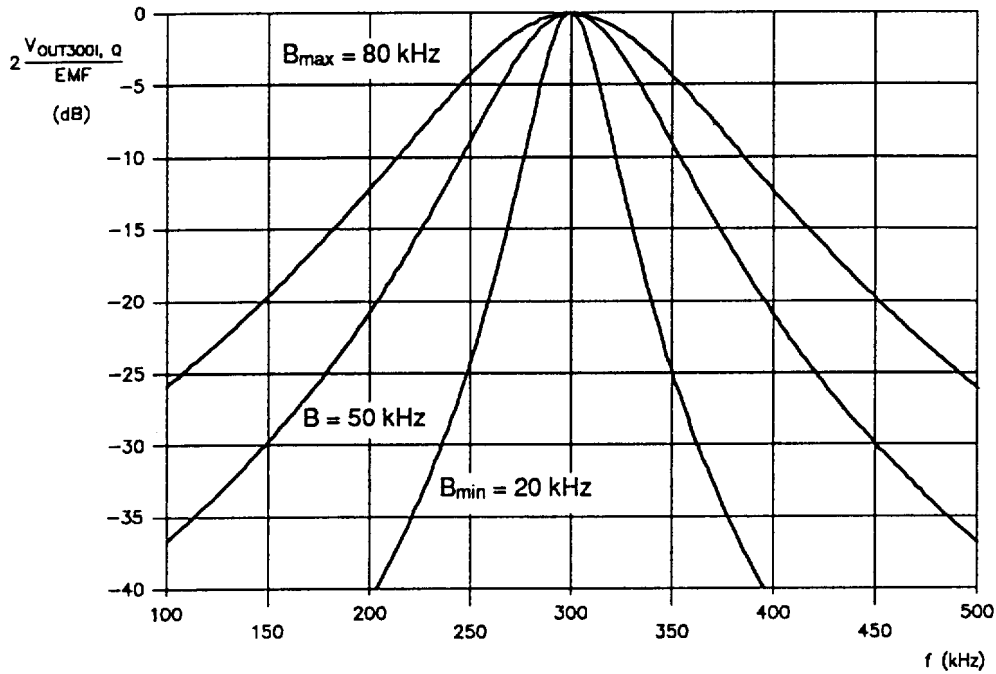

Fig.5 IF filter frequency response.

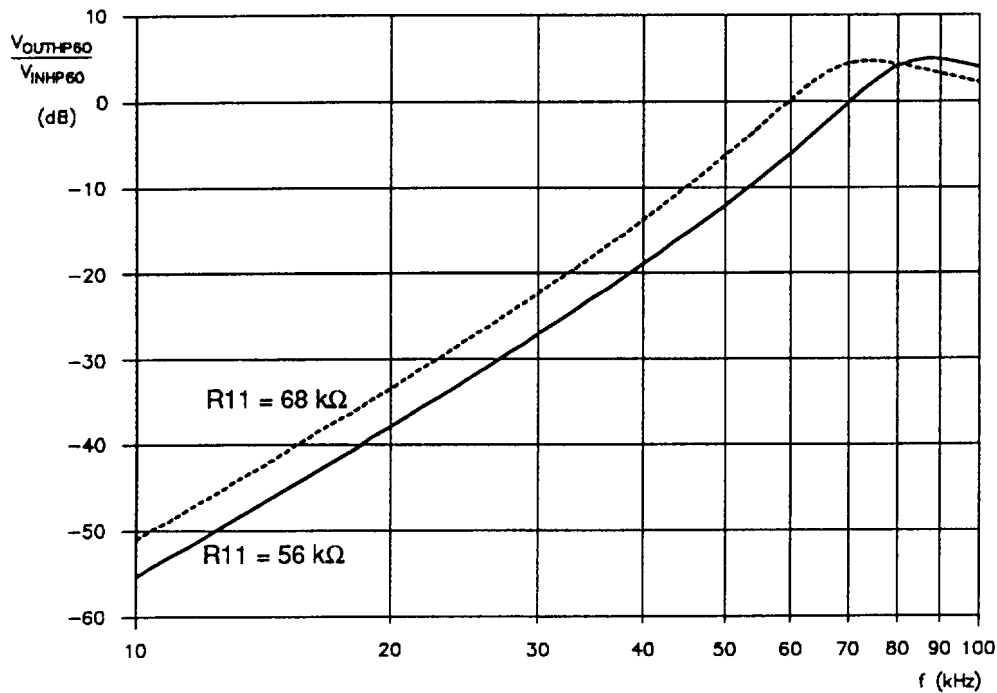

Fig.6 High-pass frequency response (see Fig.1).

IF filter / amplifier / demodulator for FM
radio receivers

TEA6850

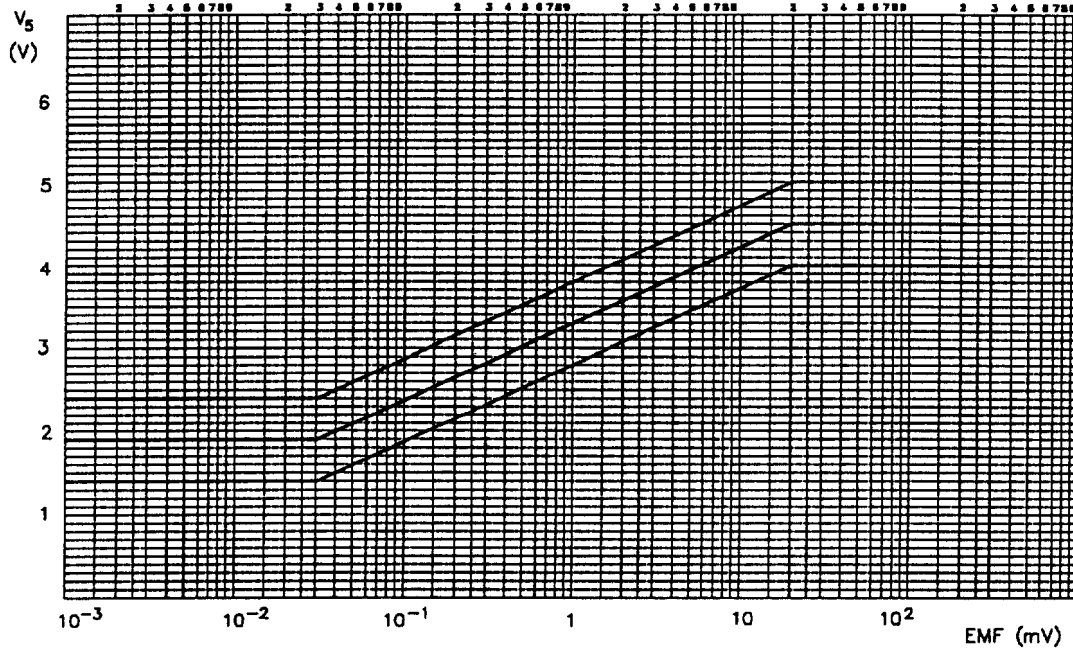

Fig.7 LEVELAMP output voltage.

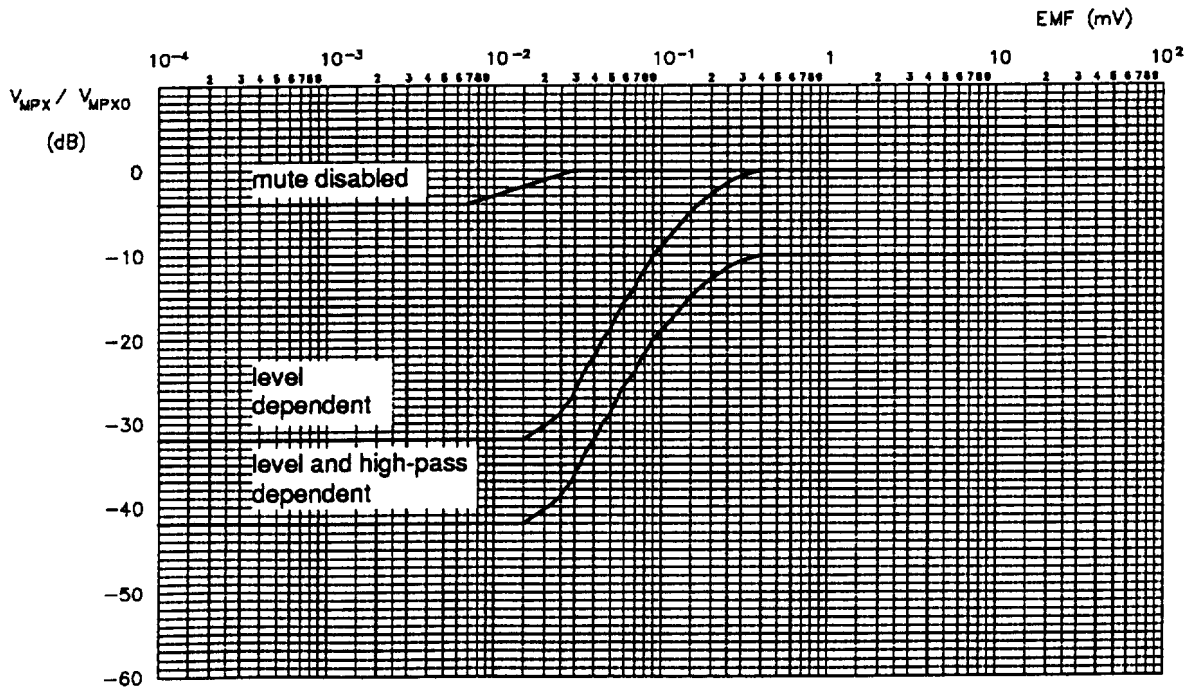

Fig.8 Soft mute curve.

IF filter / amplifier / demodulator for FM
radio receivers

TEA6850

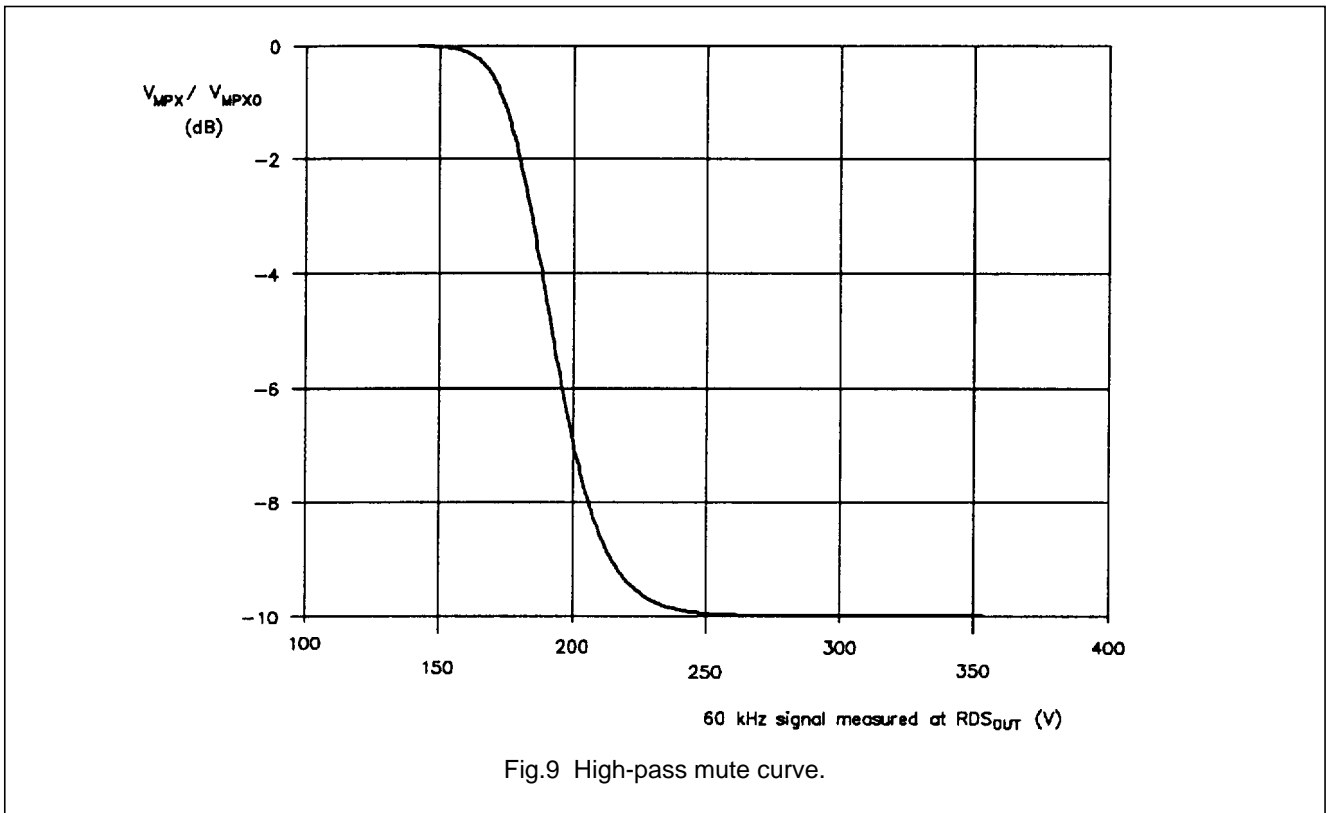

Fig.9 High-pass mute curve.

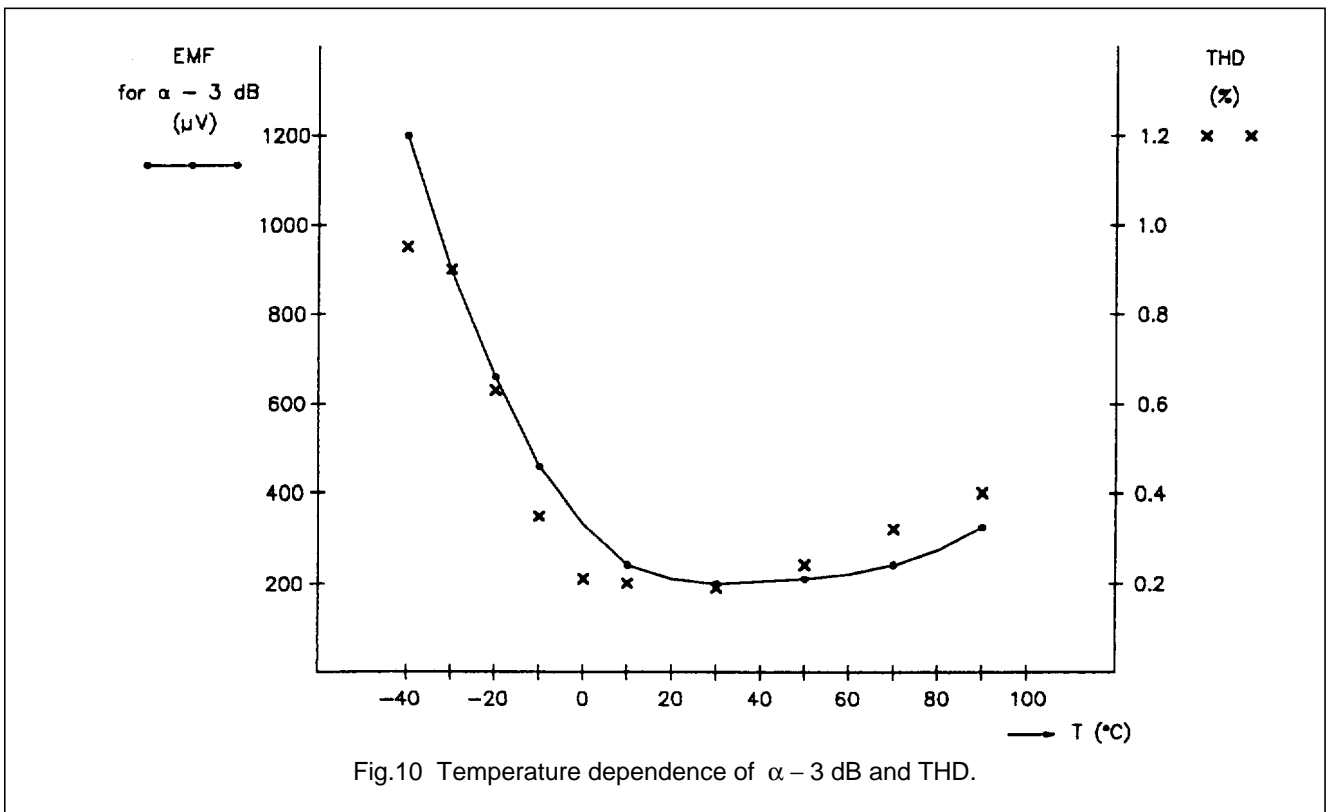

Fig.10 Temperature dependence of $\alpha - 3$ dB and THD.

**IF filter / amplifier / demodulator for FM
radio receivers**

TEA6850**APPENDIX****Alignment procedure for the test circuit (see Fig.4)**

1. Connect a spectrum analyser to pin 21 or pin 22. Set centre frequency to 300 kHz and frequency span from 200 kHz to 400 kHz.
2. Set frequency of RF-generator to 10.7 MHz, EMF-level to 4 mV RMS, modulation frequency to 1 kHz and frequency deviation to 75 kHz.
3. Turn poti P7 in the mid position. Align centre frequency of the tunable IF-filter with poti P5. The alignment is correct, if the spectrum measured at pin 21 is symmetric.
4. Set frequency deviation of RF-generator to zero (EMF = 4 mV RMS). Align the downconverter gain with poti P1. The alignment is correct, if the level at pin 21 is 2 mV RMS.
5. Short pin 36 and pin 37. Set frequency of RF-generator to 10.6 MHz respectively 10.8 MHz (EMF = 4 mV RMS, $\Delta f = 0$). Align bandwidth of the tunable IF-filter with poti P7. The alignment is correct, if the level measured at 200 kHz respectively 400 kHz is 21 dB below the maximum. Remove the short.
6. Set frequency of the RF-generator to 10.7 MHz, EMF-level to 20 mV RMS, modulation frequency to 1 kHz and frequency deviation to 22.5 kHz. Measure level of the 1 kHz signal at pin 4. Set the EMF-level to 200 μ V. Align start of mute ($\alpha - 3$ dB) with poti P2.
7. Set EMF-level back to 20 mV RMS and vary the modulation frequency. Align MPX output voltage ripple (see ΔV_O in the AC CHARACTERISTICS) with poti P6.

IF filter / amplifier / demodulator for FM
radio receivers

TEA6850

PACKAGE OUTLINE

QFP44: plastic quad flat package; 44 leads (lead length 1.3 mm); body 10 x 10 x 1.75 mm

SOT307-2

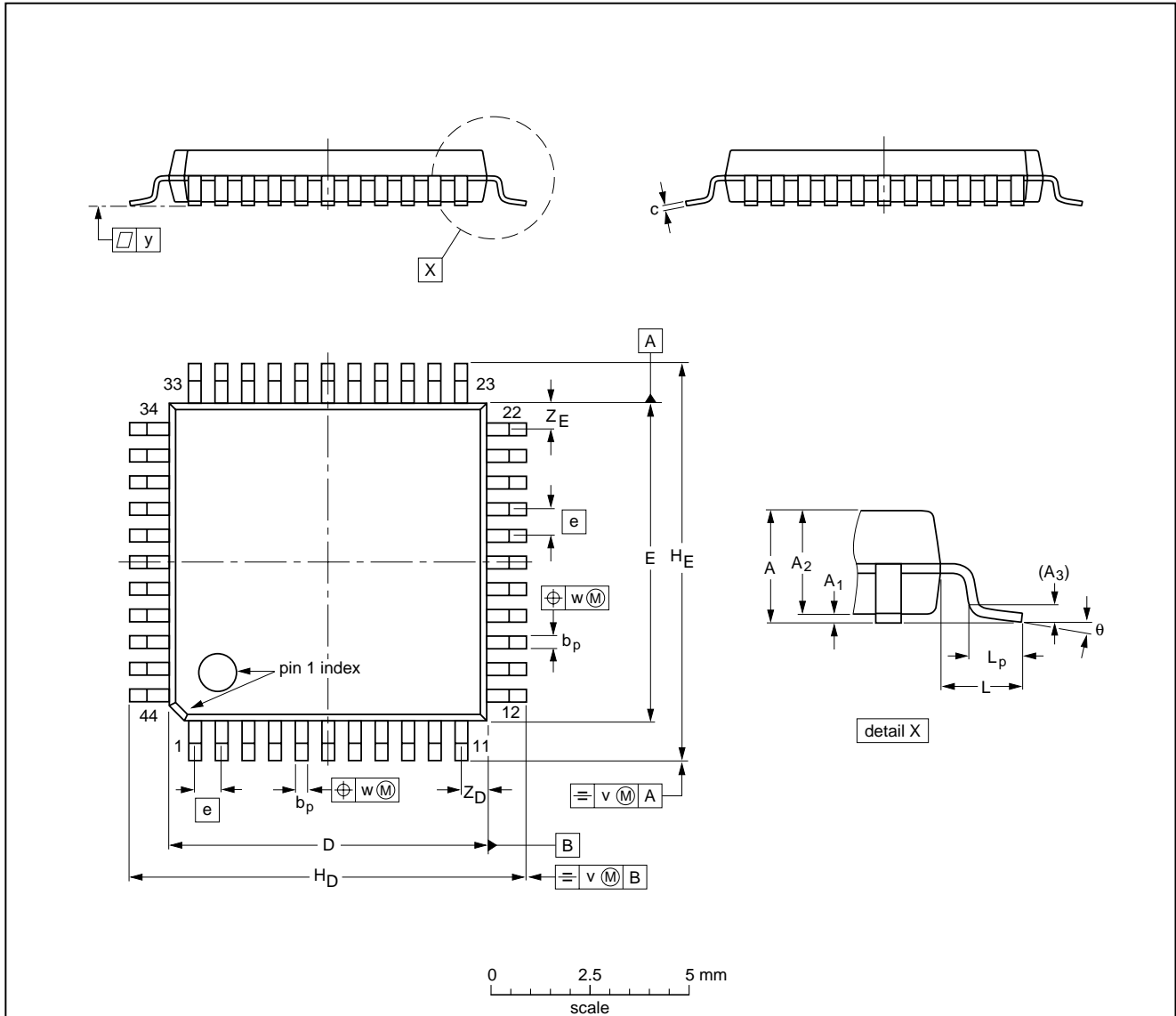

DIMENSIONS (mm are the original dimensions)

UNIT	A max.	A ₁	A ₂	A ₃	b _p	c	D ⁽¹⁾	E ⁽¹⁾	e	H _D	H _E	L	L _p	v	w	y	Z _D ⁽¹⁾	Z _E ⁽¹⁾	θ
mm	2.10	0.25 0.05	1.85 1.65	0.25	0.40 0.20	0.25 0.14	10.1 9.9	10.1 9.9	0.8	12.9 12.3	12.9 12.3	1.3	0.95 0.55	0.15	0.15	0.1	1.2 0.8	1.2 0.8	10° 0°

Note

1. Plastic or metal protrusions of 0.25 mm maximum per side are not included.

OUTLINE VERSION	REFERENCES				EUROPEAN PROJECTION	ISSUE DATE
	IEC	JEDEC	EIAJ			
SOT307-2						95-02-04 97-08-01

IF filter / amplifier / demodulator for FM radio receivers

TEA6850

SOLDERING

Introduction

There is no soldering method that is ideal for all IC packages. Wave soldering is often preferred when through-hole and surface mounted components are mixed on one printed-circuit board. However, wave soldering is not always suitable for surface mounted ICs, or for printed-circuits with high population densities. In these situations reflow soldering is often used.

This text gives a very brief insight to a complex technology. A more in-depth account of soldering ICs can be found in our "IC Package Databook" (order code 9398 652 90011).

Reflow soldering

Reflow soldering techniques are suitable for all QFP packages.

The choice of heating method may be influenced by larger plastic QFP packages (44 leads, or more). If infrared or vapour phase heating is used and the large packages are not absolutely dry (less than 0.1% moisture content by weight), vaporization of the small amount of moisture in them can cause cracking of the plastic body. For more information, refer to the Drypack chapter in our "Quality Reference Handbook" (order code 9397 750 00192).

Reflow soldering requires solder paste (a suspension of fine solder particles, flux and binding agent) to be applied to the printed-circuit board by screen printing, stencilling or pressure-syringe dispensing before package placement.

Several techniques exist for reflowing; for example, thermal conduction by heated belt. Dwell times vary between 50 and 300 seconds depending on heating method. Typical reflow temperatures range from 215 to 250 °C.

Preheating is necessary to dry the paste and evaporate the binding agent. Preheating duration: 45 minutes at 45 °C.

Wave soldering

Wave soldering is **not** recommended for QFP packages. This is because of the likelihood of solder bridging due to closely-spaced leads and the possibility of incomplete solder penetration in multi-lead devices.

If wave soldering cannot be avoided, the following conditions must be observed:

- **A double-wave (a turbulent wave with high upward pressure followed by a smooth laminar wave) soldering technique should be used.**
- **The footprint must be at an angle of 45° to the board direction and must incorporate solder thieves downstream and at the side corners.**

Even with these conditions, do not consider wave soldering the following packages: QFP52 (SOT379-1), QFP100 (SOT317-1), QFP100 (SOT317-2), QFP100 (SOT382-1) or QFP160 (SOT322-1).

During placement and before soldering, the package must be fixed with a droplet of adhesive. The adhesive can be applied by screen printing, pin transfer or syringe dispensing. The package can be soldered after the adhesive is cured.

Maximum permissible solder temperature is 260 °C, and maximum duration of package immersion in solder is 10 seconds, if cooled to less than 150 °C within 6 seconds. Typical dwell time is 4 seconds at 250 °C.

A mildly-activated flux will eliminate the need for removal of corrosive residues in most applications.

Repairing soldered joints

Fix the component by first soldering two diagonally-opposite end leads. Use only a low voltage soldering iron (less than 24 V) applied to the flat part of the lead. Contact time must be limited to 10 seconds at up to 300 °C. When using a dedicated tool, all other leads can be soldered in one operation within 2 to 5 seconds between 270 and 320 °C.

**IF filter / amplifier / demodulator for FM
radio receivers**

TEA6850**DEFINITIONS**

Data sheet status	
Objective specification	This data sheet contains target or goal specifications for product development.
Preliminary specification	This data sheet contains preliminary data; supplementary data may be published later.
Product specification	This data sheet contains final product specifications.
Limiting values	
Limiting values given are in accordance with the Absolute Maximum Rating System (IEC 134). Stress above one or more of the limiting values may cause permanent damage to the device. These are stress ratings only and operation of the device at these or at any other conditions above those given in the Characteristics sections of the specification is not implied. Exposure to limiting values for extended periods may affect device reliability.	
Application information	
Where application information is given, it is advisory and does not form part of the specification.	

LIFE SUPPORT APPLICATIONS

These products are not designed for use in life support appliances, devices, or systems where malfunction of these products can reasonably be expected to result in personal injury. Philips customers using or selling these products for use in such applications do so at their own risk and agree to fully indemnify Philips for any damages resulting from such improper use or sale.

Mouser Electronics

Authorized Distributor

Click to View Pricing, Inventory, Delivery & Lifecycle Information:

[NXP:](#)

[TEA6850HN/V102Y](#) [TEA6850HN/V102K](#)