



SMA3109

ON Semiconductor®

<http://onsemi.com>

MMIC

Amplifier, 3V, 16mA, 0.1 to 3.6GHz, MCPH6

Features

- High Gain : $G_p=23\text{dB typ. @1GHz}$
- Wideband response : $f_u=3.6\text{GHz}$
- Low current : $I_{CC}=16\text{mA typ.}$
- High output power : $P_o(1\text{dB})=4\text{dBm}$
- Port impedance : input/output 50Ω

Specifications

Absolute Maximum Ratings at $T_a=25^\circ\text{C}$

Parameter	Symbol	Conditions	Ratings	Unit
Supply Voltage	V_{CC}		5	V
Circuit Current	I_{CC}		25	mA
Allowable Power Dissipation	P_D		280	mW
Operating Temperature	T_{opr}		-40 to +85	$^\circ\text{C}$
Storage Temperature	T_{stg}		-55 to +150	$^\circ\text{C}$

Stresses exceeding Maximum Ratings may damage the device. Maximum Ratings are stress ratings only. Functional operation above the Recommended Operating Conditions is not implied. Extended exposure to stresses above the Recommended Operating Conditions may affect device reliability.

Package Dimensions

unit : mm (typ)
7022A-018

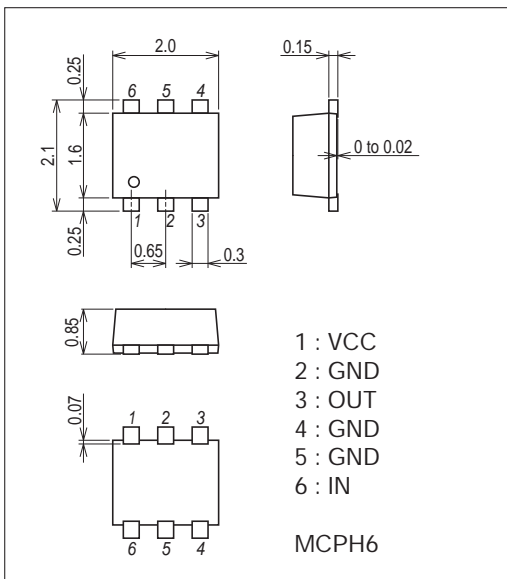

Product & Package Information

- Package : MCPH6
- JEITA, JEDEC : SC82, SC82A, SC88
- Minimum Packing Quantity : 3,000pcs/reel

Type of Taping: TL

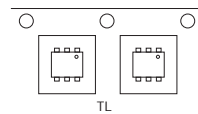

Marking

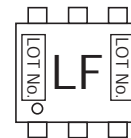

SMA3109

Recommended Operating Conditions at $T_a=25^\circ\text{C}$

Parameter	Symbol	Conditions	Ratings			Unit
			min	typ	max	
Supply Voltage	VCC		2.7	3	3.3	V
Operating Ambient Temperature	Topr		-40	+25	+85	$^\circ\text{C}$

Electrical Characteristics at $T_a=25^\circ\text{C}$, $V_{CC}=3\text{V}$, $Z_s=Z_L=50\Omega$

Parameter	Symbol	Conditions	Ratings			Unit
			min	typ	max	
Circuit Current	ICC		11.5	16.0	20.5	mA
Power Gain	Gp	f=1GHz	21.0	23.0	26.0	dB
		f=2.2GHz	22.0	24.0	27.0	
Isolation	ISL	f=1GHz	27.0	31.5		dB
		f=2.2GHz	27.0	31.5		
Input Return Loss	RLin	f=1GHz	16.0	20.5		dB
		f=2.2GHz	10.0	15.0		
Output Return Loss	RLout	f=1GHz	15.0	20.0		dB
		f=2.2GHz	10.0	14.0		
Noise Figure	NF	f=1GHz		4.3	5.0	dB
		f=2.2GHz		4.3	5.0	
Gain 1dB Compression Output Power	Po(1dB)	f=1GHz	4.0	6.4		dBm
		f=2.2GHz	2.0	4.2		
Upper Limit Operating Frequency	fu	3dB down below flat gain at f =1GHz		3.6		GHz

Note) Pay attention to handling since it is liable to be affected by static electricity due to the high frequency process adopted.

Test Circuit

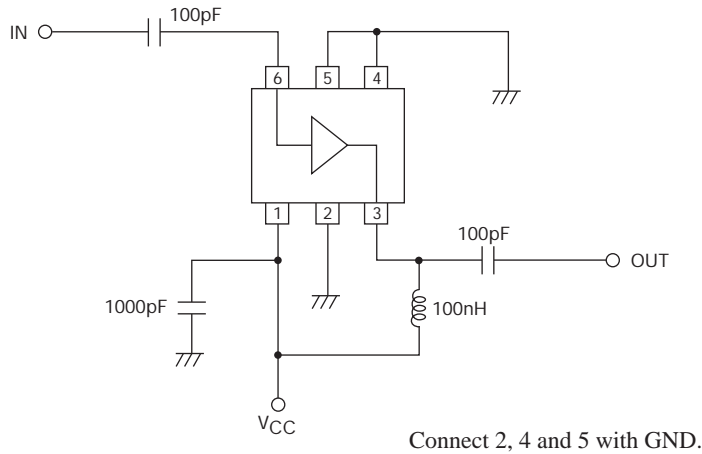

IT15580

Evaluation Board

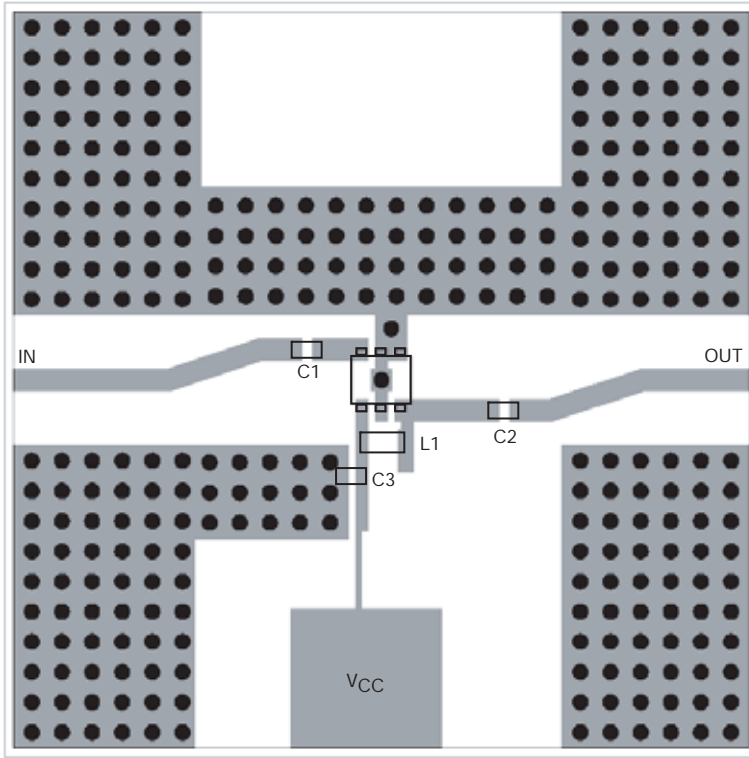

Symbol	Value
C1, C2	100pF
C3	1000pF
L1	100nH

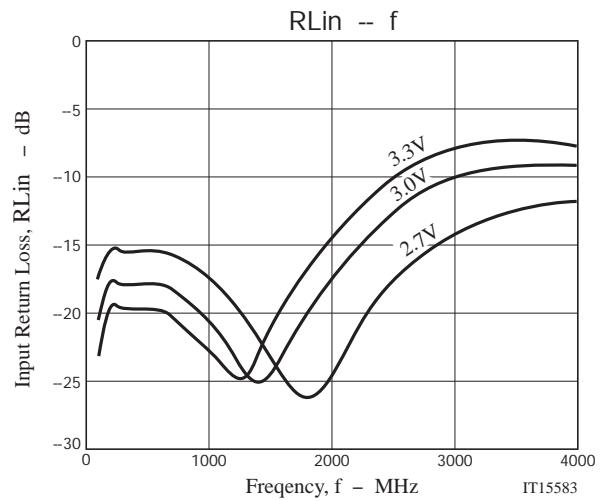
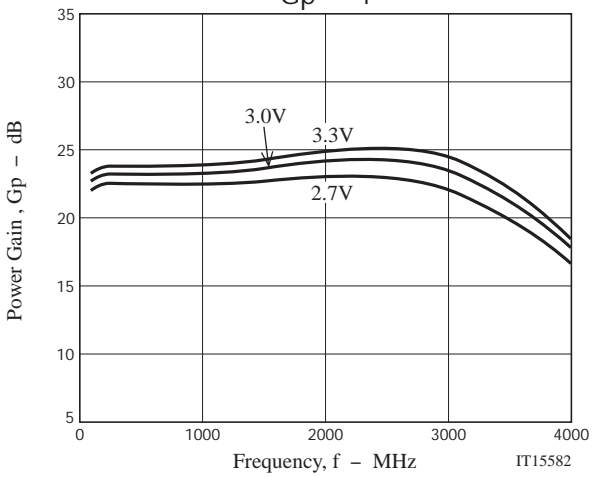
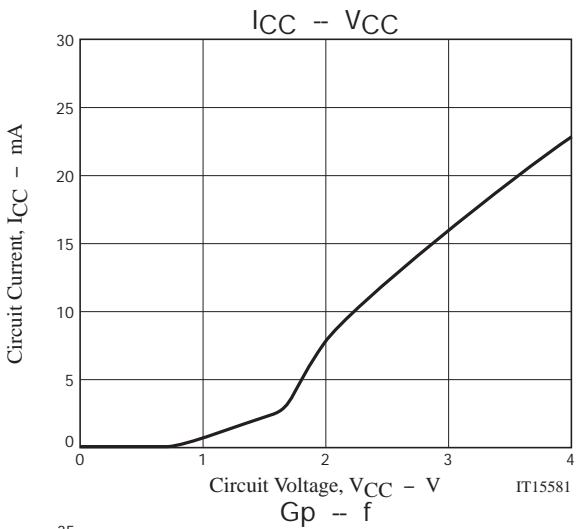

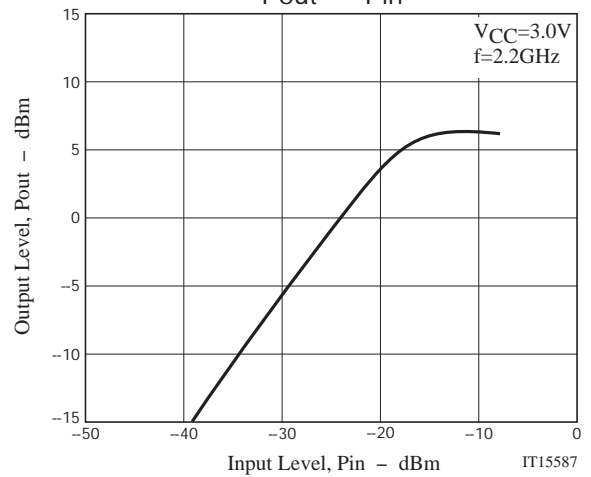
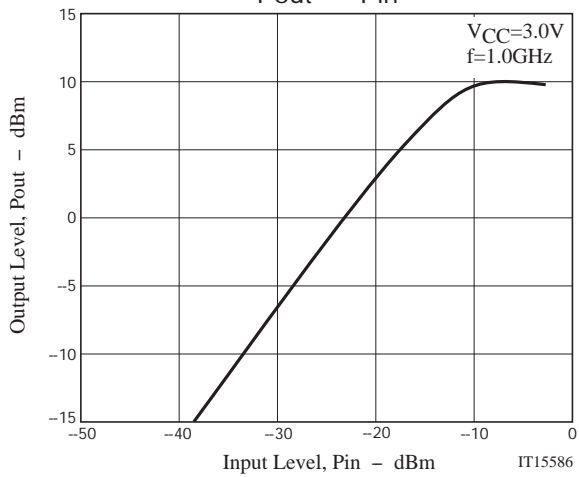
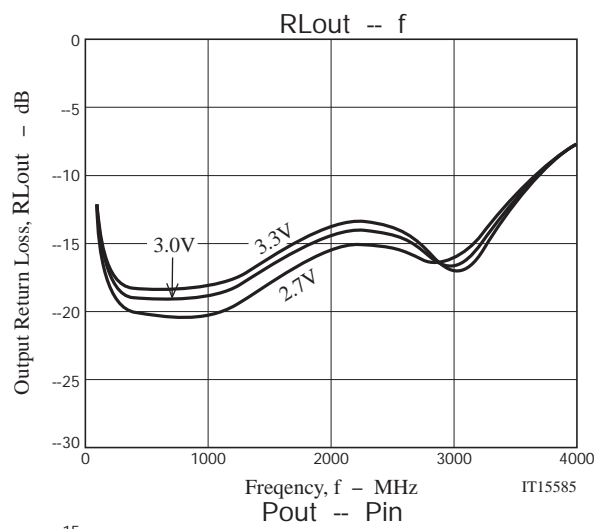
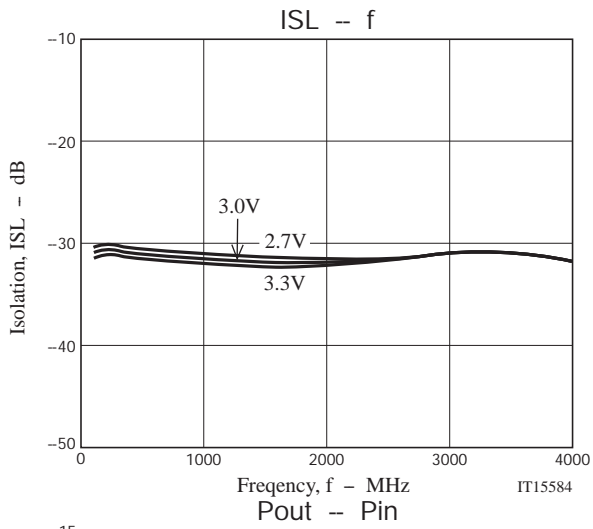

S Parameter
S11

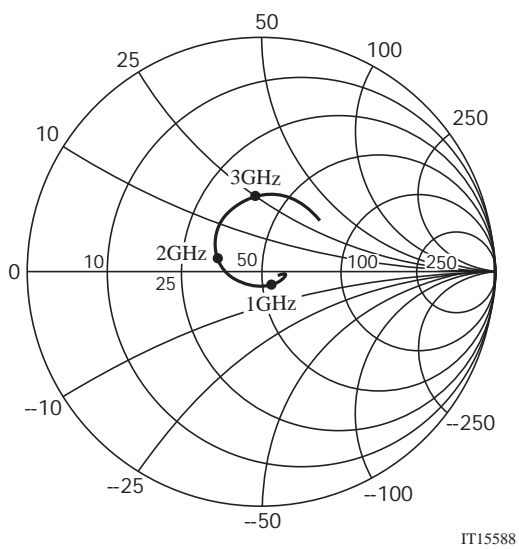

S22

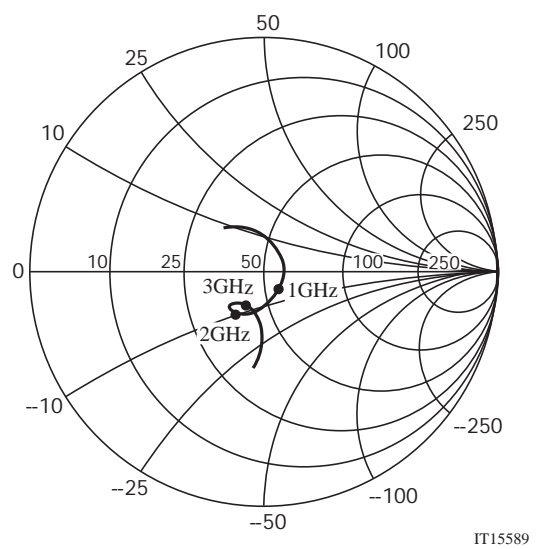

ON Semiconductor and the ON logo are registered trademarks of Semiconductor Components Industries, LLC (SCILLC). SCILLC owns the rights to a number of patents, trademarks, copyrights, trade secrets, and other intellectual property. A listing of SCILLC's product/patent coverage may be accessed at www.onsemi.com/site/pdf/Patent-Marking.pdf. SCILLC reserves the right to make changes without further notice to any products herein. SCILLC makes no warranty, representation or guarantee regarding the suitability of its products for any particular purpose, nor does SCILLC assume any liability arising out of the application or use of any product or circuit, and specifically disclaims any and all liability, including without limitation special, consequential or incidental damages. "Typical" parameters which may be provided in SCILLC data sheets and/or specifications can and do vary in different applications and actual performance may vary over time. All operating parameters, including "Typicals" must be validated for each customer application by customer's technical experts. SCILLC does not convey any license under its patent rights nor the rights of others. SCILLC products are not designed, intended, or authorized for use as components in systems intended for surgical implant into the body, or other applications intended to support or sustain life, or for any other application in which the failure of the SCILLC product could create a situation where personal injury or death may occur. Should Buyer purchase or use SCILLC products for any such unintended or unauthorized application, Buyer shall indemnify and hold SCILLC and its officers, employees, subsidiaries, affiliates, and distributors harmless against all claims, costs, damages, and expenses, and reasonable attorney fees arising out of, directly or indirectly, any claim of personal injury or death associated with such unintended or unauthorized use, even if such claim alleges that SCILLC was negligent regarding the design or manufacture of the part. SCILLC is an Equal Opportunity/Affirmative Action Employer. This literature is subject to all applicable copyright laws and is not for resale in any manner.

Mouser Electronics

Authorized Distributor

Click to View Pricing, Inventory, Delivery & Lifecycle Information:

[ON Semiconductor:](#)

[SMA3109-TL-E](#)