

Very low power module for Bluetooth[®] Smart v4.1

Datasheet - production data



Features

- Bluetooth v4.1 compliant
 - Supports master and slave modes
 - Multiple roles supported simultaneously
- Embedded Bluetooth low energy protocol stack
 - GAP, GATT, SM, L2CAP, LL, RFPHY
- Bluetooth low energy profiles provided separately
- Bluetooth radio performance:
 - Embedded ST BlueNRG-MS
 - Tx power: + 4 dBm
 - Rx sensitivity: - 88 dBm
 - Provides up to 92 dB link budget with excellent link reliability
- Host interface
 - SPI, IRQ, and RESET
 - On-field stack upgrading available via SPI
- AES security co-processor
- Certification
 - CE qualified
 - FCC, IC modular approval certified
 - BQE qualified
- On-board chip antenna
- Operating supply voltage: from 1.7 to 3.6 V
- Operating temperature range: -40 °C to 85 °C

Applications

- Watches
- Fitness, wellness and sports
- Consumer medical
- Security/proximity
- Remote control
- Home and industrial automation
- Assisted living
- Mobile phone peripherals
- PC peripherals

Description

The SPBTLE-RF is an easy to use Bluetooth[®] Smart master/slave network processor module, compliant with Bluetooth v4.1. The SPBTLE-RF B-SmarT module supports multiple roles simultaneously, and can act at the same time as Bluetooth Smart sensor and hub device.

The entire Bluetooth Smart stack and protocols are embedded into SPBTLE-RF B-SmarT module. The external host application processor, where the application resides, is connected to the SPBTLE-RF B-SmarT module through a standard SPI interface.

The SPBTLE-RF B-SmarT module provides a complete RF platform in a tiny form factor. Radio, antenna, high frequency and LPO oscillators are integrated to offer a certified solution to optimize the time to market of the final applications.

The SPBTLE-RF can be powered directly with a standard 3 V coin cell battery, a pair of AAA batteries or any power source from 1.7 to 3.6 V.

Contents

- 1 General description 3**
- 2 Block diagram 4**
- 3 Software architecture 5**
 - 3.1 Bluetooth firmware implementation 5
- 4 Hardware specifications 6**
 - 4.1 Absolute maximum ratings 6
 - 4.2 Recommended operating conditions 6
 - 4.3 Current consumption 6
 - 4.4 Current consumption comparison 7
 - 4.5 Pin assignment 10
 - 4.6 Mechanical dimensions 11
- 5 Hardware design 13**
 - 5.1 Reflow soldering 13
- 6 Regulatory compliance 15**
 - 6.1 FCC certification 15
 - 6.1.1 Labeling instructions 15
 - 6.1.2 Product manual instructions 16
 - 6.2 IC certification 16
 - 6.2.1 Labeling instructions 17
 - 6.2.2 Product manual instructions 18
 - 6.3 CE certification for SPBTLE-RF module 19
 - 6.4 Bluetooth certification 19
- 7 Ordering information 20**
- 8 ECOPACK® 21**
- 9 Traceability 21**
- 10 Revision history 22**



1 General description

The SPBTLE-RF is a single-mode Bluetooth low energy master/slave network processor module compliant with Bluetooth® v4.1.

The SPBTLE-RF B-SmarT module integrates a 2.4 GHz RF radio the ST BlueNRG-MS on which a complete power-optimized stack for Bluetooth single mode protocol runs, providing

- Master, slave role support
- GAP: central, peripheral, observer or broadcaster roles
- ATT/GATT: client and server
- SM: privacy, authentication and authorization
- L2CAP
- Link Layer: AES-128 encryption and decryption

The BlueNRG-MS radio embeds nonvolatile Flash memory allows on-field stack upgrading.

In addition, according the Bluetooth specification v4.1 the SPBTLE-RF B-SmarT module provides:

- Multiple roles simultaneously support
- Support simultaneous advertising and scanning
- Support being slave of up to two masters simultaneously
- Privacy V1.1
- Low duty cycle directed advertising
- Connection parameters request procedure
- LE Ping
- 32 bits UUIDs
- L2CAP connection oriented channels

The SPBTLE-RF B-SmarT module is equipped with Bluetooth low energy profiles in C source code, available for the ST radio BlueNRG-MS.

The external host application processor, where the application resides, is interfaced with the SPBTLE-RF B-SmarT module through an application controller interface protocol, which is based on a standard SPI interface.

The SPBTLE-RF B-SmarT module enables wireless connectivity into electronic devices, not requiring any RF experience or expertise for integration into the final product. The SPBTLE-RF B-SmarT module provides a complete RF platform in a tiny form factor and being a certified solution optimizes the time to market of the final applications.

The SPBTLE-RF B-SmarT module allows applications to meet of the tight advisable peak current requirements imposed with the use of standard coin cell batteries. Optimized results are obtained when the embedded high-efficiency DC-DC step-down converter is used. SPBTLE-RF can be powered directly with a standard 3 V coin cell battery, a pair of AAA batteries or any power source from 1.7 to 3.6 V.

ST may update the FW provided with the modules at any time. ST recommends that users regularly check for documentation and the current FW version available at www.st.com/bluemodules.

2 Block diagram

Figure 1. HW block diagram

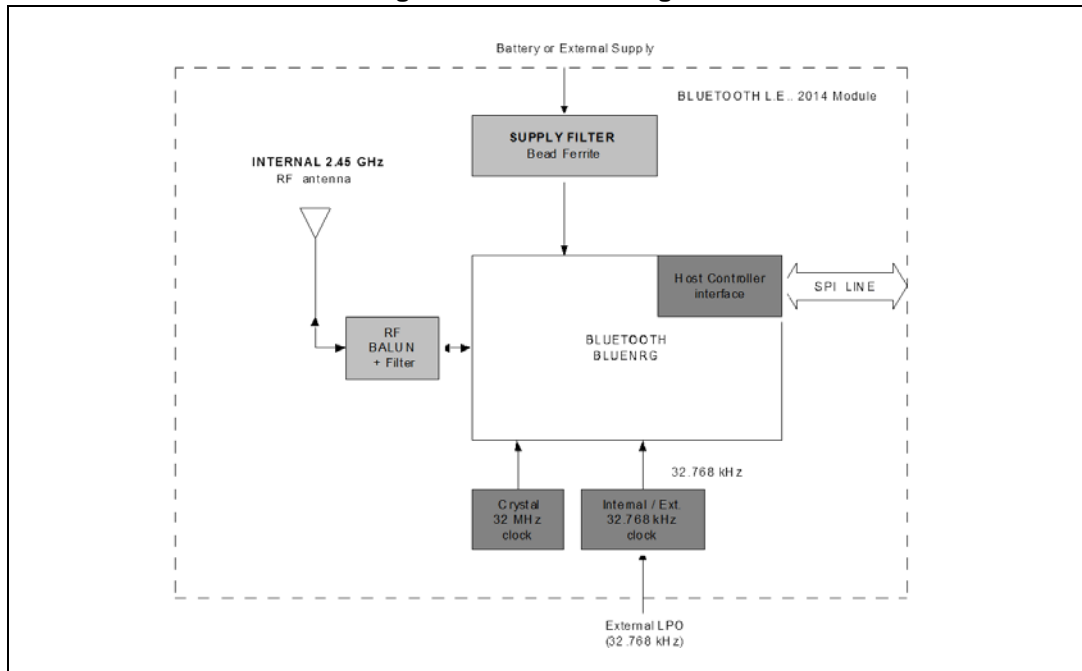

3 Software architecture

3.1 Bluetooth firmware implementation

Figure 2. SPBTLE-RF application block diagram

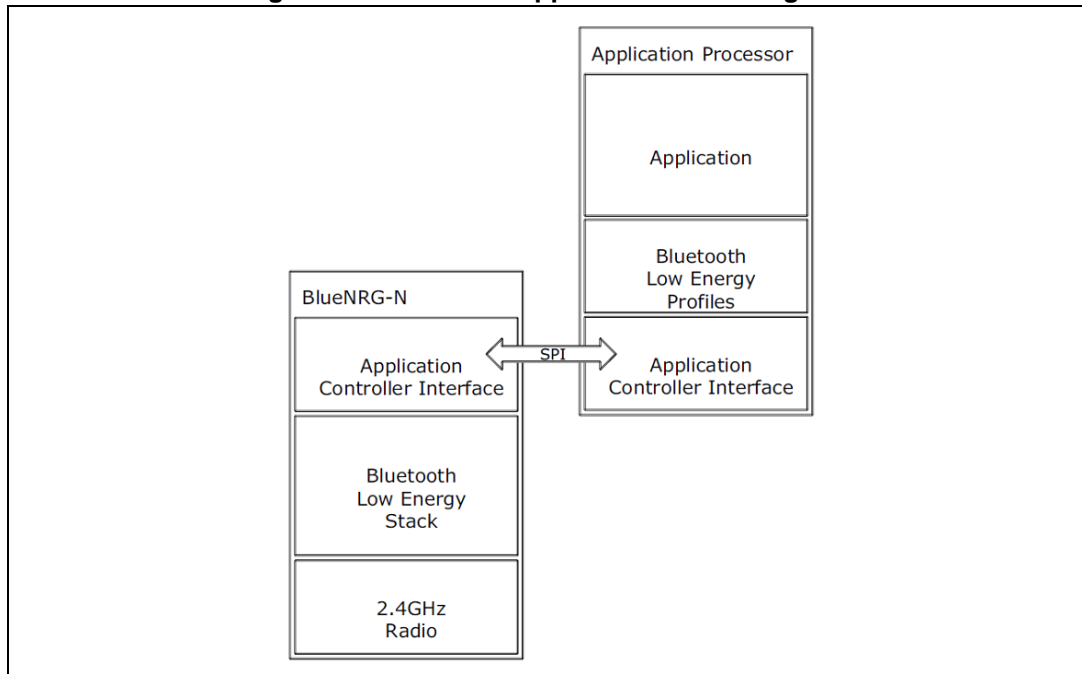

4 Hardware specifications

General conditions (V_{IN} = 3.3 V and 25 °C)

4.1 Absolute maximum ratings

Table 1. Absolute maximum ratings

Rating	Min	Typ.	Max	Unit
Storage temperature range	-40	-	+85	°C
Supply voltage, V_{IN}	-0.3	-	3.9	V
I/O pin Voltage (V_{IO} five-volt tolerant pin)	-0.3	-	3.9	V
RF saturation input power	-	8	-	dBm

4.2 Recommended operating conditions

Table 2. Recommended operating conditions

Rating	Min	Typ.	Max	Unit
Storage temperature range	-40	-	+85	°C
Supply voltage, V_{IN}	1.7	3.3	3.6	V
Signals & I/O pin voltage (according supply voltage)	1.7	-	3.6	V
RF Frequency	2402	-	2480	MHz

4.3 Current consumption

Table 3. Current consumption summary

Symbol	Parameter	Test conditions	Typ.	Unit
I_{DD}	Supply current	Shutdown / STANDBY	1.98	μ A
		Peripheral in advertising (20 ms)	0.850	mA
		Peripheral in advertising (80 ms)	0.250	mA
		Peripheral in connection	0.103	mA
		Central in scan mode	7.72	mA
		Central in connection	0.105	mA

4.4 Current consumption comparison

The measured values reported in table 3 have been compared with the value calculated with the “BlueNRG current consumption estimation tool”, available on ST.com at:

<http://www.st.com/web/en/catalog/tools/PF260405>

The comparison between measured and calculated values is reported in following [Table 4](#).

Table 4. Current consumption comparison summary

Symbol	Parameter	Test conditions	Typ.	Peak	Calculated	Unit	Calculated value reference
I _{DD}	Supply current	Shutdown / STANDBY	1.98		2	μA	BlueNRG-MS Datasheet Table 7
		Peripheral in advertising (20 ms)	0.850	11.5	0.985	mA	Screenshot Figure 3
		Peripheral in advertising (80 ms)	0.250	15.7	0.247	mA	Screenshot Figure 4
		Peripheral in connection	0.103	15	0.119	mA	Screenshot Figure 5
		Central in scan mode	7.72	8.5	7.1 - 7.4	mA	Screenshot Figure 6
		Central in connection	0.105	12.85	0.106	mA	Screenshot Figure 7

For each calculated value refer to the following screenshot

Figure 3. Peripheral in advertising (20 ms)

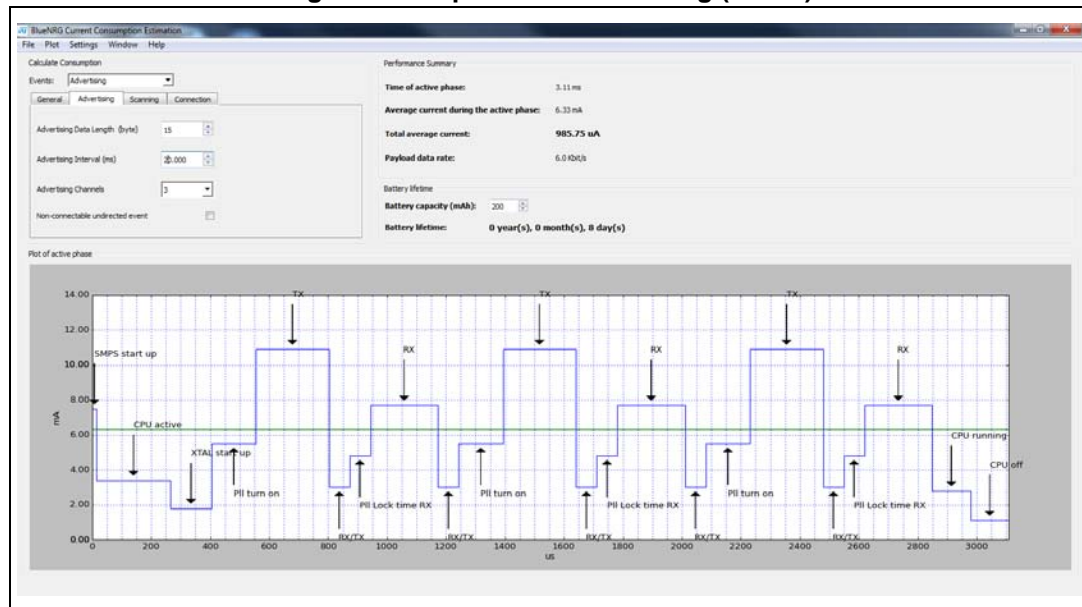

Figure 4. Peripheral in advertising (80 ms)

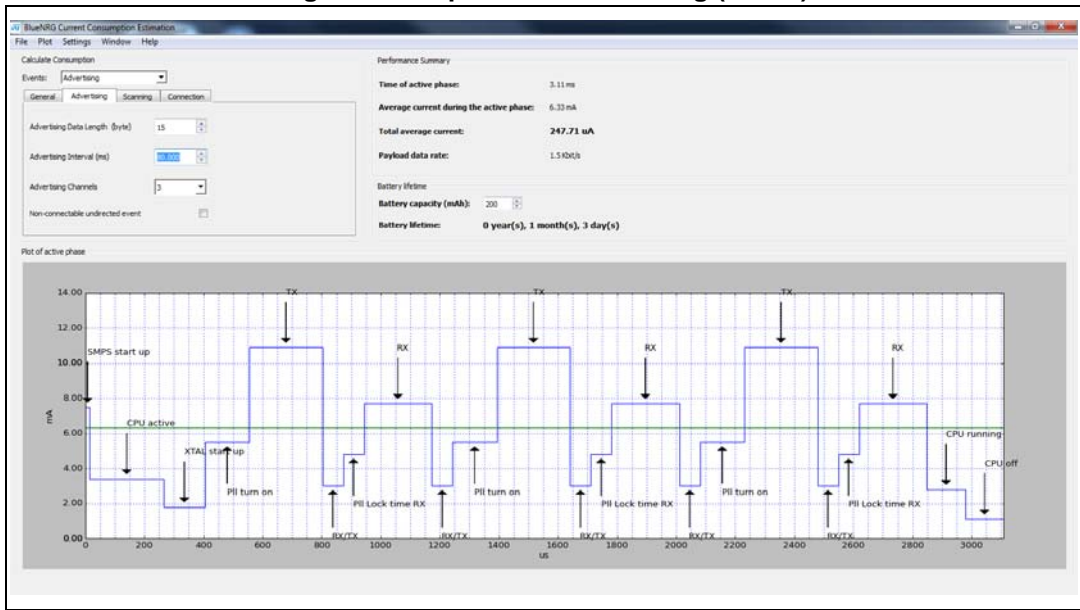

Figure 5. Peripheral in connection

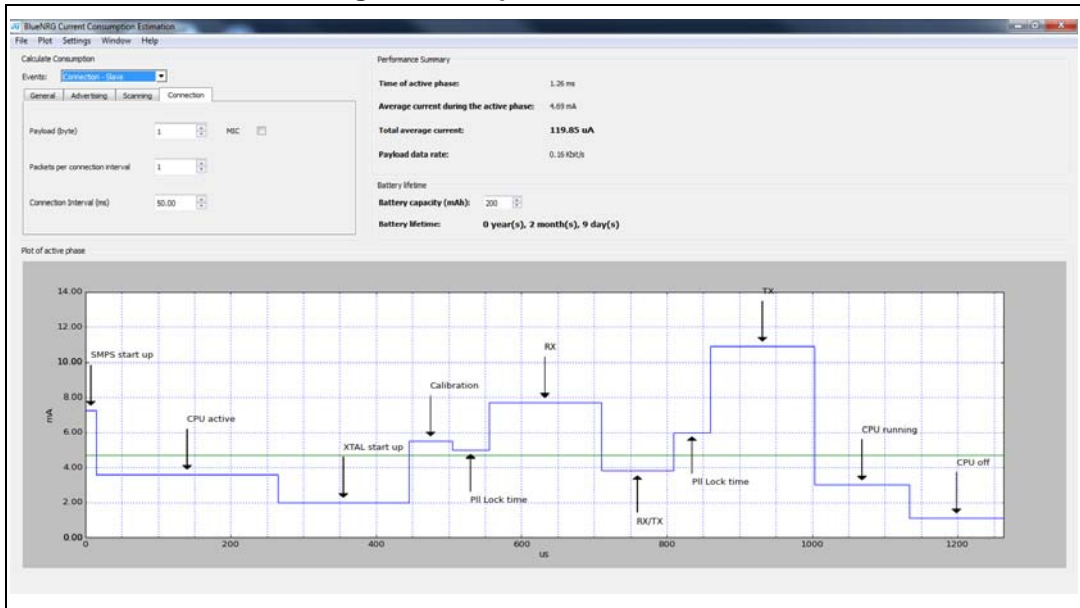

Figure 6. Central in scan mode

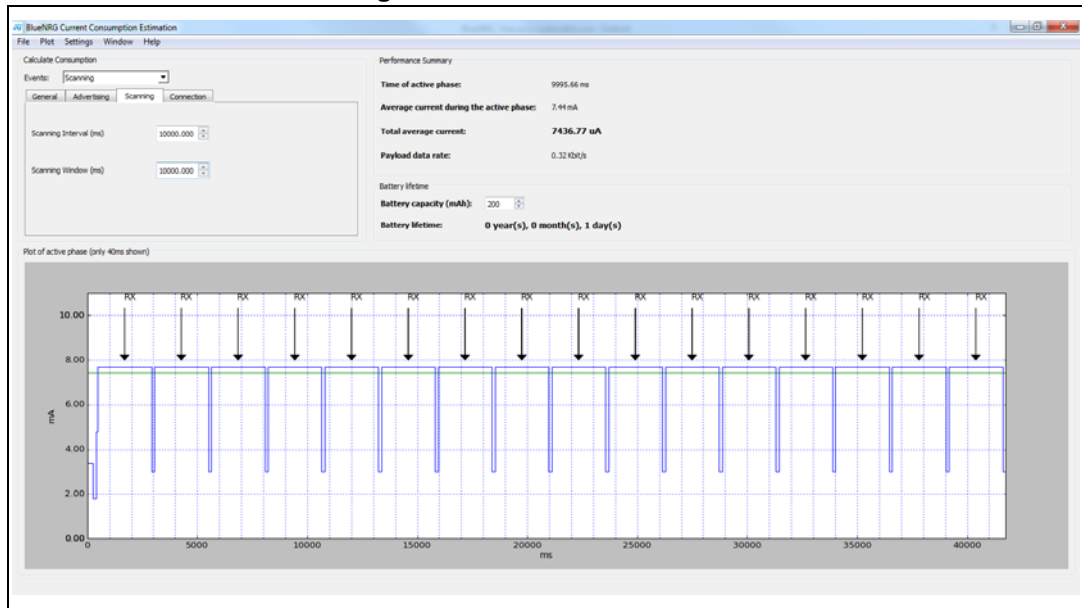
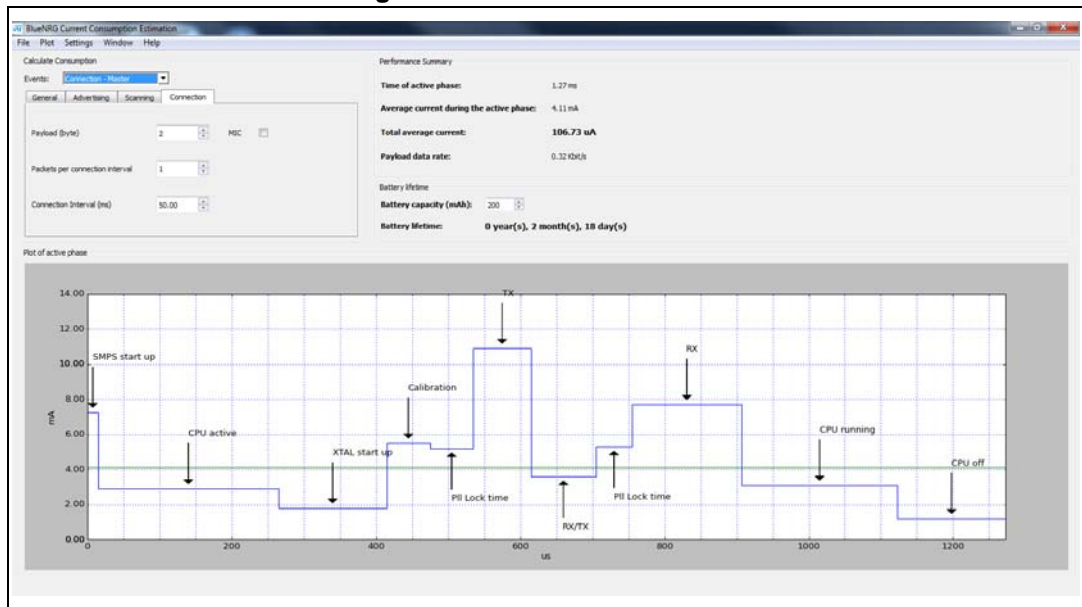

Figure 7. Central in connection



4.5 Pin assignment

Figure 8. Pin connection

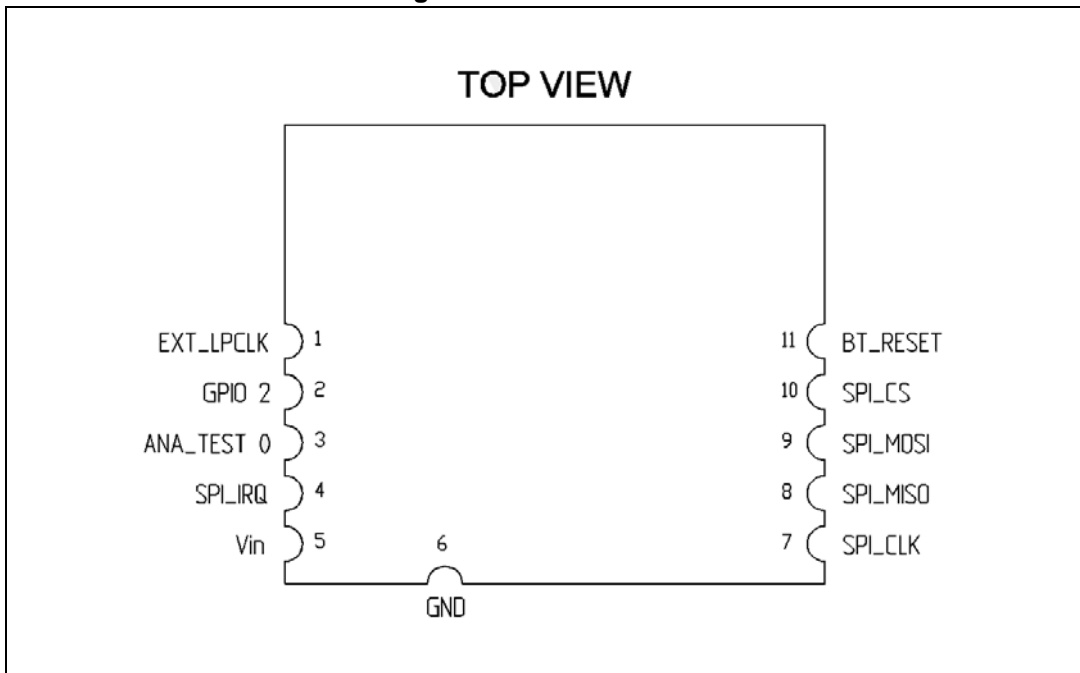

Table 5. Pin assignment

Name	Type	Pin #	Description	V max. Tolerant
SPI Interface				
SPI_IRQ	O	4	SPI IRQ (SLAVE has data for MASTER)	V _{in}
SPI_CLK	I	7	SPI CLOCK (Max. 8 MHz)	V _{in}
SPI_MISO	O	8	SPI MISO (MASTER in / SLAVE out)	V _{in}
SPI_MOSI	I	9	SPI MOSI (MASTER out SLAVE in)	V _{in}
SPI_CS	I	10	SPI "Chip select" (SPI slave select)	V _{in}
Power and ground				
V _{in}		5	V _{in}	(1.7V - 3.6V max.)
GND		6	GND	
Reset				
BT_RESET	I	11	Reset input (active low < 0.35 V _{in})	(1.7V - 3.6V max.)
LPO				
EXT_LPCLK	I	1	Not connected	
GPIO2	I/O	2	Not connected	
ANA TEST 0	I	3	Not connected	

4.6 Mechanical dimensions

Figure 9. Mechanical dimensions

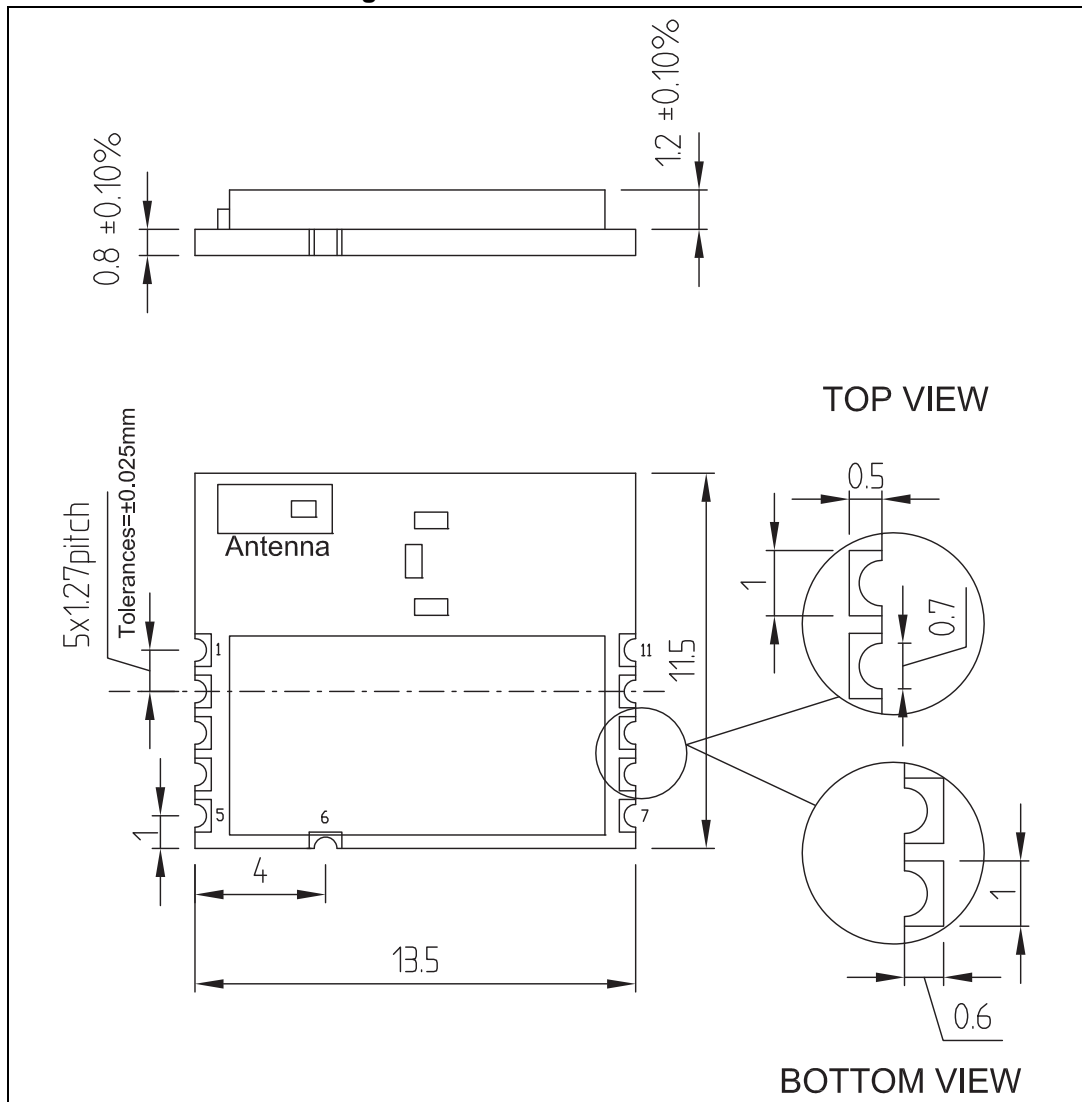
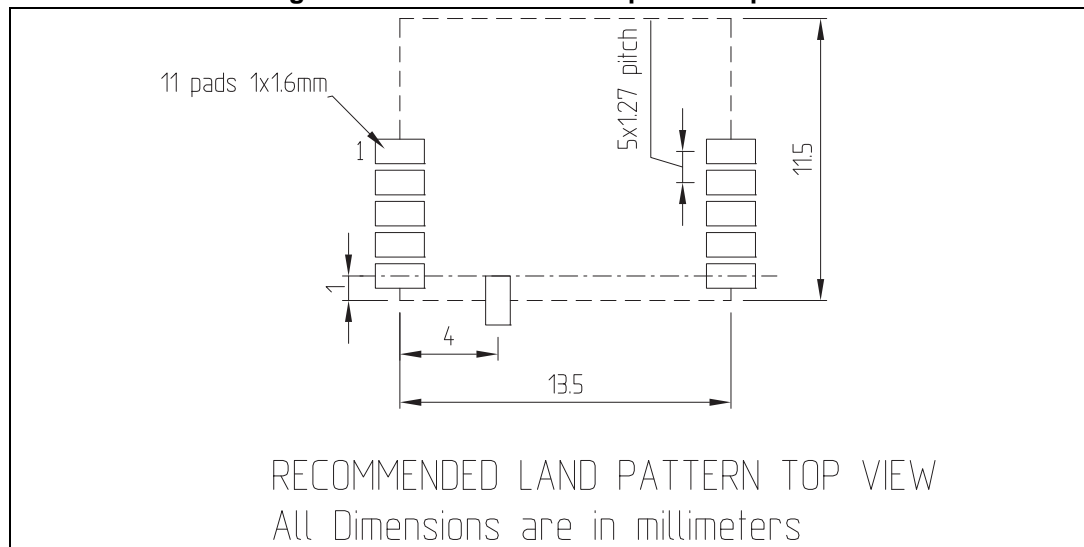

Figure 10. Recommend land pattern top view



5 Hardware design

SPBTLE-RF module supports SPI hardware interfaces.

Note:

- All unused pins should be left floating; do not ground.
- All GND pins must be well grounded.
- The area around the module should be free of any ground planes, power planes, trace routings, or metal for 6 mm from the module antenna position, in all directions.
- Traces should not be routed underneath the module.

5.1 Reflow soldering

The SPBTLE-RF is a high temperature strength surface mount Bluetooth® module supplied on a 11 pin, 4-layer PCB. The final assembly recommended reflow profiles are indicated here below.

Soldering phase has to be executed with care: in order to avoid undesired melting phenomenon, particular attention has to be taken on the set up of the peak temperature.

Here following some suggestions for the temperature profile based on following recommendations.

Table 6. Soldering

Profile feature	PB-free assembly
Average ramp up rate ($T_{S\text{MAX}}$ to T_p)	3°C/ sec max
Preheat	
Temperature min (T_S mn)	150 °C
Temperature max (T_S max)	200 °C
Time (t_S min to t_S max) (t_S)	60-100 sec
Time maintained above:	
Temperature T_L	217 °C
Time t_L	60-70 sec
Peak temperature (T_p)	240 + 0 °C
Time within 5 °C of actual peak temperature (T_p)	10-20 sec
Ramp down rate	6 °C/sec
Time from 25 °C to peak temperature	8 minutes max

Figure 11. Soldering profiles

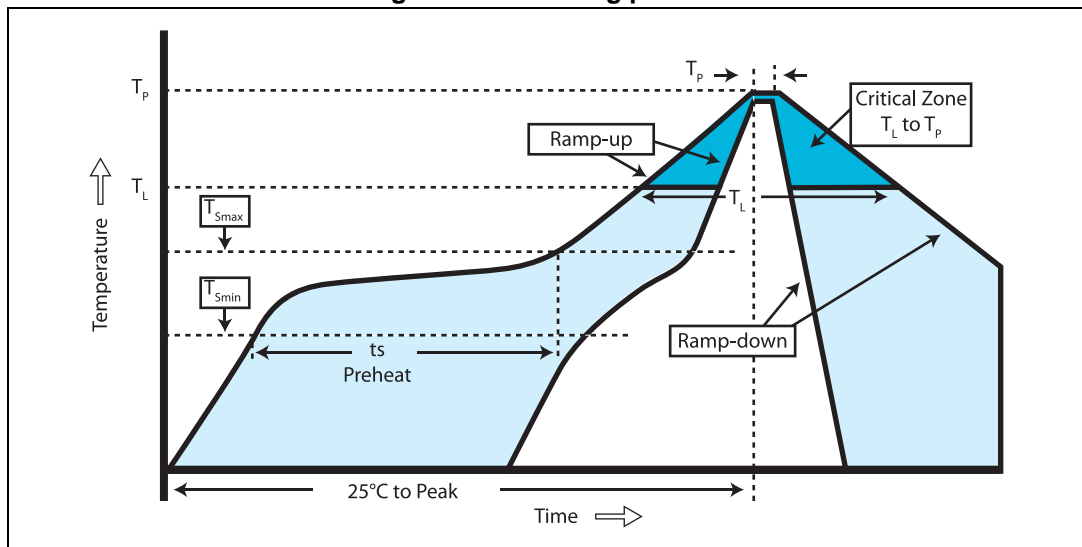

6 Regulatory compliance

6.1 FCC certification

This module has been tested and found to comply with the FCC part 15 rules. These limits are designed to provide reasonable protection against harmful interference in approved installations. This equipment generates, uses, and can radiate radio frequency energy and, if not installed and used in accordance with the instructions, may cause harmful interference to radio communications.

However, there is no guarantee that interference may not occur in a particular installation.

This device complies with part 15 of the FCC rules. Operation is subject to the following two conditions:

1. This device may not cause harmful interference,
and
2. this device must accept any interference received, including interference that may cause undesired operation.

Modifications or changes to this equipment not expressly approved by STMicroelectronics may render void the user's authority to operate this equipment.

Modular approval

FCC ID: S9NSPBTLERF

In accordance with FCC part 15, the SPBTLE-RF is listed as a modular transmitter device.

This module is evaluated for stand-alone use only. Finished products incorporating multiple transmitters must comply with colocation and RF exposure requirements in accordance with FCC multi-transmitter product procedures. Collocated transmitters operating in portable RF Exposure conditions (e.g. <20 cm from persons including but not limited to body worn and hand held devices) may require separate approval.

6.1.1 Labeling instructions

When integrating the SPBTLE-RF into the final product, the OEM must ensure that the FCC labeling requirements are satisfied. A statement must be included on the exterior of the final product which indicates the product includes a certified module. The label should state the following (or similar wording that conveys the same meaning):

Contains FCC ID: S9NSPBTLERF

OR

This product contains FCC ID: S9NSPBTLERF

The OEM must include the following statements on the exterior of the final product unless the product is too small (e.g. less than 4 x 4 inches):

This device complies with Part 15 of the FCC Rules. Operation is subject to the following two conditions:

1. this device may not cause harmful interference,
and
2. this device must accept any interference received, including any interference that may cause undesired operation.

6.1.2 Product manual instructions

This section applies to OEM final products containing the SPBTLE-RF module, subject to FCC compliance. The final product manual must contain the following statement (or a similar statement that conveys the same meaning):

Warning: Changes or modifications not expressly approved by the party responsible for compliance could void the user's authority to operate the equipment. (Part. 15.21)

In the case where an OEM seeks Class B (residential) limits for the final product, the following statement must be included in the final product manual:

Note: This equipment has been tested and found to comply with the limits for a Class B digital device, pursuant to part 15 of the FCC Rules. These limits are designed to provide reasonable protection against harmful interference in a residential installation. This equipment generates, uses and can radiate radio frequency energy and, if not installed and used in accordance with the instructions, may cause harmful interference to radio communications. However, there is no guarantee that interference will not occur in a particular installation. If this equipment does cause harmful interference to radio or television reception, which can be determined by turning the equipment off and on, the user is encouraged to try to correct the interference by one or more of the following measures:

- Reorient or relocate the receiving antenna.
- Increase the separation between the equipment and receiver.
- Connect the equipment into an outlet on a circuit different from that to which the receiver is connected.
- Consult the dealer or an experienced radio/TV technician for help.

In the case where an OEM seeks the lesser category of a Class A digital device for the final product, the following statement must be included in the final product manual:

Note: This equipment has been tested and found to comply with the limits for a Class A digital device, pursuant to part 15 of the FCC Rules. These limits are designed to provide reasonable protection against harmful interference when the equipment is operated in a commercial environment. This equipment generates, uses, and can radiate radio frequency energy and, if not installed and used in accordance with the instruction manual, may cause harmful interference to radio communications. Operation of this equipment in a residential area is likely to cause harmful interference in which case the user will be required to correct the interference at his expense.

6.2 IC certification

The SPBTLE-RF module has been tested and found compliant with the IC RSS-210 rules. These limits are designed to provide reasonable protection against harmful interference in

approved installations. This equipment generates, uses, and can radiate radio frequency energy and, if not installed and used in accordance with the instructions, may cause harmful interference to radio communications.

However, there is no guarantee that interference may not occur in a particular installation.

This device complies with RSS-210 of the IC rules. Operation is subject to the following two conditions:

1. this device may not cause harmful interference,
- and
2. this device must accept any interference received, including interference that may cause undesired operation.

Modifications or changes to this equipment not expressly approved by STMicroelectronics may render void the user's authority to operate this equipment.

Modular approval

IC: 8976C-SPBTLERF

In accordance with IC RSS-210, the SPBTLE-RF is listed as a modular transmitter device.

This module is evaluated for stand-alone use only. Finished products incorporating multiple transmitters must comply with colocation and RF exposure requirements in accordance with IC multi-transmitter product procedures. Collocated transmitters operating in portable RF Exposure conditions (e.g. <20cm from persons including but not limited to body worn and hand held devices) may require separate approval.

6.2.1 Labeling instructions

When integrating the SPBTLE-RF into the final product, the OEM must ensure that the IC labeling requirements are satisfied. A statement must be included on the exterior of the final product which indicates that the product includes a certified module. The label should state the following (or similar wording that conveys the same meaning):

Contains IC: 8976C-SPBTLERF

OR

This product contains IC: 8976C-SPBTLERF

The OEM must include the following statements on the exterior of the final product unless the product is too small (e.g. less than 4 x 4 inches):

This device complies with RSS-210 of the IC Rules. Operation is subject to the following two conditions:

1. this device may not cause harmful interference,
- and
2. this device must accept any interference received, including any interference that may cause undesired operation.

6.2.2 Product manual instructions

This section applies to OEM final products containing the SPBTLE-RF module, subject to IC compliance. The final product manual must contain the following statement (or a similar statement that conveys the same meaning):

Warning: Changes or modifications not expressly approved by the party responsible for compliance could void the user's authority to operate the equipment. (RSS-210)

In the case where an OEM seeks Class B (residential) limits for the final product, the following statement must be included in the final product manual:

Note: This equipment has been tested and found to comply with the limits for a Class B digital device, pursuant to RSS-210 of the IC Rules. These limits are designed to provide reasonable protection against harmful interference in a residential installation. This equipment generates, uses and can radiate radio frequency energy and, if not installed and used in accordance with the instructions, may cause harmful interference to radio communications. However, there is no guarantee that interference will not occur in a particular installation. If this equipment does cause harmful interference to radio or television reception, which can be determined by turning the equipment off and on, the user is encouraged to try to correct the interference by one or more of the following measures:

- Reorient or relocate the receiving antenna.
- Increase the separation between the equipment and receiver.
- Connect the equipment into an outlet on a circuit different from that to which the receiver is connected.
- Consult the dealer or an experienced radio/TV technician for help.

In the case where an OEM seeks the lesser category of a Class A digital device for the final product, the following statement must be included in the final product manual:

Note: This equipment has been tested and found to comply with the limits for a Class A digital device, pursuant to RSS-210 of the IC Rules. These limits are designed to provide reasonable protection against harmful interference when the equipment is operated in a commercial environment. This equipment generates, uses, and can radiate radio frequency energy and, if not installed and used in accordance with the instruction manual, may cause harmful interference to radio communications. Operation of this equipment in a residential area is likely to cause harmful interference in which case the user will be required to correct the interference at his expense.

6.3 CE certification for SPBTLE-RF module

The SPBTLE-RF module has been certified according to the following standards:

- EN 60950-1:2006 + A11:2009 + A12:2011 + A1:2010 + A2:2013 + AC:2011
- ETSI EN 301 489-1 V1.9.2:2011
- ETSI EN 301 489-17 V2.2.1
- ETSI EN 300 328 V1.8.1:2012
- ETSI EN 300 328 V1.9.1 (2015)
- EN62479:2010

CE Expert opinion: 0561-ARSP00053

The module is CE certified:

CE0051

6.4 Bluetooth certification

The module with embedded stack and profile has been qualified in accordance with SIG qualification rules:

- Declaration ID: D028766
- Qualified design ID: 71984
- Product type: End Product
- Core spec version: 4.1
- Product description: Bluetooth Smart v4.1 module

7 Ordering information

Table 7. Ordering information

Order code	Description	Packing	MOQ
SPBTLE-RF	Bluetooth® V4.1 smart module	JEDEC tray	2448 pcs

8 ECOPACK®

In order to meet environmental requirements, ST offers these devices in different grades of ECOPACK® packages, depending on their level of environmental compliance. ECOPACK® specifications, grade definitions and product status are available at: www.st.com. ECOPACK® is an ST trademark.

9 Traceability

Each module is univocally identified by serial number stored in a 2D data matrix laser marked on the bottom side of the module itself.

The serial number has the following format:

Table 8. Traceability information

Letter	Meaning
WW	Week
YY	Year
D	Product ID family
FF	Production panel coordinate identification
NNN	Progressive serial number.

Each module bulk is identified by a bulk ID.

BULK ID and module 2D data matrix are linked by a reciprocal traceability link.

The module 2D data matrix traces the lot number of any raw material used.

10 Revision history

Table 9. Document revision history

Date	Revision	Changes
07-May-2015	1	Initial release.
09-Jul-2015	2	Inserted: <i>Section 4.3</i> and <i>Section 4.4</i> .
03-Nov-2015	3	– Document status promoted from preliminary data to production data. – Added <i>Section 6.4: Bluetooth certification</i> .
17-Dec-2015	4	Updated figure on the cover page.
11-Jan-2016	5	Updated BQE feature on the cover page.
08-Jun-2016	6	Added paragraph regarding firmware update in <i>Section 1: General description</i> .

IMPORTANT NOTICE – PLEASE READ CAREFULLY

STMicroelectronics NV and its subsidiaries ("ST") reserve the right to make changes, corrections, enhancements, modifications, and improvements to ST products and/or to this document at any time without notice. Purchasers should obtain the latest relevant information on ST products before placing orders. ST products are sold pursuant to ST's terms and conditions of sale in place at the time of order acknowledgement.

Purchasers are solely responsible for the choice, selection, and use of ST products and ST assumes no liability for application assistance or the design of Purchasers' products.

No license, express or implied, to any intellectual property right is granted by ST herein.

Resale of ST products with provisions different from the information set forth herein shall void any warranty granted by ST for such product.

ST and the ST logo are trademarks of ST. All other product or service names are the property of their respective owners.

Information in this document supersedes and replaces information previously supplied in any prior versions of this document.

© 2016 STMicroelectronics – All rights reserved

