

# 用于桥接传感器的 ADS123x 2 通道和 4 通道、24 位、Delta-Sigma 模数转换器

## 1 特性

- 适用于桥式传感器的完整前端
- 23.5 位有效分辨率 (增益 = 1)
- 19.2 位无噪声分辨率 (增益 = 64)
- 低噪声 PGA
- 1、2、64 和 128 可选增益
- RMS 噪声：
  - 10SPS 时为 17nV (增益 = 128)
  - 80SPS 时为 44nV (增益 = 128)
- 100dB 同步 50Hz 和 60Hz 抑制
- 灵活的时钟：
  - 低漂移内部振荡器
  - 可选外部晶体
- 可选择 10SPS 或 80SPS 数据速率
- 简单的比例式测量：
  - 最高 5V 的外部电压基准
- 双通道差分输入，带内部温度传感器 (ADS1232)
- 四通道差分输入 (ADS1234)
- 双线串行接口
- 电源电压范围：2.7V 至 5.3V
- 温度范围：-40°C 至 +105°C
- 封装：TSSOP-24 (ADS1232) 或 TSSOP-28 (ADS1234)

## 2 应用

- [称重秤](#)
- [PLC 重量模块](#)
- [压力传感器](#)

## 3 说明

ADS1232 和 ADS1234 (ADS123x) 是精密的 24 位模数转换器 (ADC)。凭借低噪声可编程增益放大器 (PGA)、精密  $\Delta$ - $\Sigma$  ADC 和内部振荡器，ADS123x 为桥式传感器应用 (包括称重秤、应变仪和压力传感器) 提供了一个完整的前端解决方案。

输入多路复用器 (MUX) 接受双路 (ADS1232) 或四路 (ADS1234) 差分输入。ADS1232 还包含一个用于监测环境温度的温度传感器。低噪声 PGA 具有 1、2、64 或 128 的可选择增益，支持  $\pm 2.5V$ 、 $\pm 1.25V$ 、 $\pm 39mV$  或  $\pm 19.5mV$  的满量程差分输入。

$\Delta$ - $\Sigma$  ADC 可提供最高 23.5 位有效分辨率，并支持两种数据速率：10SPS (提供 50Hz 和 60Hz 抑制) 和 80SPS。ADS123x 可以使用振荡器或晶体进行外部计时，也可以通过内部振荡器进行计时。

失调电压校准可按需执行，并且 ADS123x 可被置于低功耗待机模式，或者在断电模式中完全关断。可通过简单的引脚驱动控制来操作 ADS123x，无需对数字寄存器进行编程。

数据通过直接连接至 MSP430 或其他微控制器的一个双线制串行接口输出。

### 器件信息<sup>(1)</sup>

| 器件型号    | 封装         | 封装尺寸 (标称值)      |
|---------|------------|-----------------|
| ADS1232 | TSSOP (24) | 7.80mm × 4.40mm |
| ADS1234 | TSSOP (28) | 9.70mm × 4.40mm |

(1) 如需了解所有可用封装，请参阅产品说明书末尾的封装选项附录。

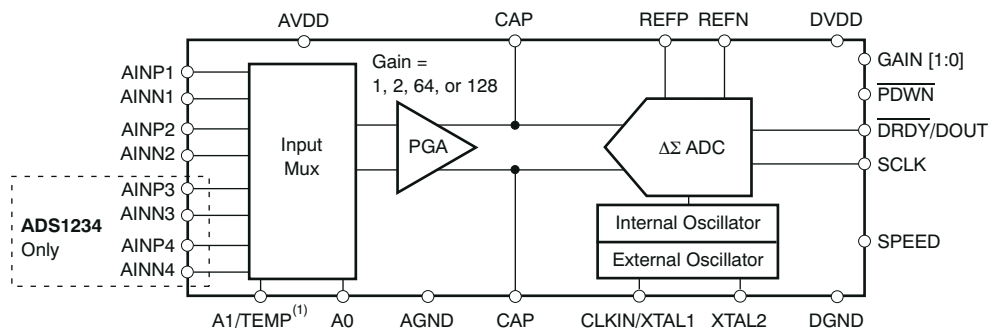

NOTE: (1) A1 for ADS1234, TEMP for ADS1232.

方框图



## Table of Contents

|   |           |   |           |
|---|-----------|---|-----------|
| 1 特性.....                                       | 1         | 8.4 Device Functional Modes.....                                | 25        |
| 2 应用.....                                       | 1         | <b>9 Application and Implementation.....</b>                    | <b>29</b> |
| 3 说明.....                                       | 1         | 9.1 Application Information.....                                | 29        |
| <b>4 Revision History.....</b>                  | <b>2</b>  | 9.2 Typical Application.....                                    | 29        |
| <b>5 Pin Configuration and Functions.....</b>   | <b>4</b>  | <b>10 Power Supply Recommendations.....</b>                     | <b>32</b> |
| <b>6 Specifications.....</b>                    | <b>6</b>  | 10.1 Power-Supply Decoupling.....                               | 32        |
| 6.1 Absolute Maximum Ratings.....               | 6         | <b>11 Layout.....</b>   | <b>33</b> |
| 6.2 ESD Ratings.....                            | 6         | 11.1 Layout Guidelines.....                                     | 33        |
| 6.3 Recommended Operating Conditions.....       | 7         | 11.2 Layout Example.....  | 34        |
| 6.4 Thermal Information.....                    | 7         | <b>12 Device and Documentation Support.....</b>                 | <b>35</b> |
| 6.5 Electrical Characteristics.....             | 8         | 12.1 接收文档更新通知.....  | 35        |
| 6.6 Typical Characteristics.....                | 10        | 12.2 支持资源.....  | 35        |
| <b>7 Parameter Measurement Information.....</b> | <b>15</b> | 12.3 Trademarks.....  | 35        |
| 7.1 Noise Performance.....                      | 15        | 12.4 静电放电警告.....  | 35        |
| <b>8 Detailed Description.....</b>              | <b>16</b> | 12.5 术语表.....   | 35        |
| 8.1 Overview.....                               | 16        | <b>13 Mechanical, Packaging, and Orderable Information.....</b> | <b>35</b> |
| 8.2 Functional Block Diagram.....               | 16        |   |           |
| 8.3 Feature Description.....                    | 16        |   |           |

## 4 Revision History

注：以前版本的页码可能与当前版本的页码不同

| Changes from Revision F (February 2008) to Revision G (January 2021)   | Page |
|--|------|
| • 更新了整个文档的表、图和交叉参考的编号格式.....   | 1    |
| • 添加了器件信息、ESD 等级、建议运行条件和热性能信息表，以及详细说明、应用和实施、电源相关建议、布局、器件和文档支持和机械、封装和可订购信息部分.....   | 1    |
| • Deleted <i>Ordering Information</i> section; all ordering information available in package option addendum located at end of data sheet..... | 4    |
| • Added analog input voltage specification to <i>Absolute Maximum Ratings</i> .....  | 6    |
| • Added digital input voltage specification to <i>Absolute Maximum Ratings</i> .....   | 6    |
| • Deleted momentary input current specification from <i>Absolute Maximum Ratings</i> .....   | 6    |
| • Added input current note to <i>Absolute Maximum Ratings</i> .....  | 6    |
| • Added common-mode voltage condition to Common-Mode Rejection specification in <i>Electrical Characteristics</i> table.....                   | 8    |
| • Deleted power-supply rejection (gain = 1) MIN specification from <i>Electrical Characteristics</i> table.....                                | 8    |
| • Changed power-supply rejection (gain = 1) TYP specification in <i>Electrical Characteristics</i> table.....                                  | 8    |
| • Changed text in <i>Analog Inputs (AINPX, AINNXX)</i> section.....  | 16   |
| • Added <i>ADS1232 Input Channel Selection With A0 and TEMP</i> table.....   | 16   |
| • Deleted link to <i>Using the MSC121x as a High-Precision Intelligent Temperature Sensor</i> .....  | 17   |
| • Changed 10 SPS - 3-dB frequency from 3.32 Hz to 2.4 Hz, and 80 SPS - 3-dB frequency from 11.64 Hz to 19 Hz.....                              | 21   |
| • Changed <i>Power-Up Sequence</i> section.....  | 27   |
| • Deleted Thermocouple application from <i>Application Information</i> .....   | 29   |
| • Deleted RTDs and Thermistor application from <i>Application Information</i> .....  | 29   |
| • Added weigh scale application to <i>Application Information</i> .....  | 29   |

| Changes from Revision E (October 2007) to Revision F (February 2008)  | Page |
|---|------|
| • Changed $\Delta V$ condition in Common-Mode Rejection specification in <i>Electrical Characteristics</i> table..... | 8    |
| • Changed AVDD to deltaV in Power-Supply Rejection section in <i>Electrical Characteristics</i> table.....            | 8    |

---

**Changes from Revision D (September 2007) to Revision E (October 2007) Page**

- Corrected unit values in *Electrical Characteristics* table.....8

---

**Changes from Revision C (June 2006) to Revision D (September 2007) Page**

- Deleted Logic Level  $V_{IH}$  row for CLKIN/XTAL test condition in *Electrical Characteristics* table.....8
- Added offset drift and gain drift histogram plots (图 6-9 to 图 6-16) to *Typical Characteristics* .....10
- Changed difference voltage output for PGA = 2 from 323.4mV to 223.4mV in *Temperature Sensor* section..17
- Added text to *Voltage Reference Inputs* section regarding reference and drift noise.....19
- Changed  $Z_{EFF}$  equation.....19
- Changed *Simplified Reference Input Circuitry* figure .....19
- Changed 图 8-4 .....20
- Changed text in *Settling Time* section.....22
- Changed 图 8-7 .....22
- Changed 图 8-8 .....22
- Deleted 2nd sentence of *Serial Clock Input* section.....23
- Added *Power-Up Sequence* section, with new text and two new figures.....27
- Changed *Weigh-Scale Application* figure .....29

---

**Changes from Revision B (September 2005) to Revision C (June 2006) Page**

- Deleted last row from *Absolute Maximum Ratings* table.....6
  - Changed *Analog Inputs* section of *Electrical Characteristics* table.....8
  - Changed the typical value in last row of *Voltage Reference Input* section of *Electrical Characteristics* table....8
  - Added note 1 to 表 7-1, 表 7-2, 表 7-3, and 表 7-4.....15
  - Changed fourth sentence in *Temperature Sensor* section.....17
  - Added fifth and sixth sentences to *Temperature Sensor* section.....17
  - Added fourth and fifth sentences to *Low-Noise PGA* section.....18
  - Changed 图 8-2.....18
  - Changed  $t_{11}$  to  $t_{10}$  in third paragraph of *Standby Mode* section.....25
  - Changed min and max variables of  $t_{10}$  row in table below 图 8-12.....25
  - Changed *Wake-Up Timing From Power-Down Mode* figure.....27
  - Added last row and second footnote to table below *Wake-Up Timing From Power-Down Mode* figure.....27
-

## 5 Pin Configuration and Functions



图 5-1. ADS1232 PW Package, 24-Pin TSSOP, Top View



图 5-2. ADS1234 PW Package, 28-Pin TSSOP, Top View

表 5-1. Pin Functions

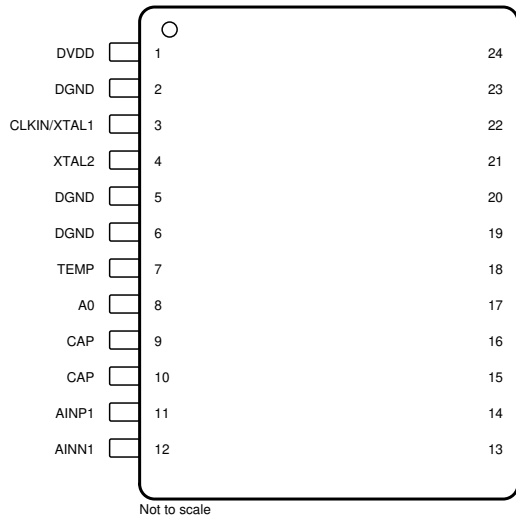
| NAME        | PIN     |         | TYPE           | DESCRIPTION   |
|-------------|---------|---------|----------------|---|
|             | ADS1232 | ADS1234 |                |   |
| A0          | 8       | 8       | Digital input  | Input MUX select pins. See 表 8-1 and 表 8-2 for more information.  |
| A1          | —       | 7       | Digital input  | Input MUX select pins. See 表 8-1 and 表 8-2 for more information.  |
| AGND        | 17      | 21      | Analog         | Analog ground   |
| AINN1       | 12      | 12      | Analog input   | Negative analog input channel 1   |
| AINN2       | 13      | 17      | Analog input   | Negative analog input channel 2   |
| AINN3       | —       | 14      | Analog input   | Negative analog input channel 3   |
| AINN4       | —       | 15      | Analog input   | Negative analog input channel 4   |
| AINP1       | 11      | 11      | Analog input   | Positive analog input channel 1   |
| AINP2       | 14      | 18      | Analog input   | Positive analog input channel 2   |
| AINP3       | —       | 13      | Analog input   | Positive analog input channel 3   |
| AINP4       | —       | 16      | Analog input   | Positive analog input channel 4   |
| AVDD        | 18      | 22      | Analog         | Analog power supply: 2.7 V to 5.3 V   |
| CAP         | 9, 10   | 9, 10   | Analog         | PGA bypass, connect a 0.1-μF capacitor to pins 9 and 10   |
| CLKIN/XTAL1 | 3       | 3       | Digital input  | External crystal connection 1, or external clock input, or tie low to activate internal oscillator. See the <a href="#">Clock Sources</a> section for more information.   |
| DGND        | 2, 5, 6 | 2, 5, 6 | Digital        | Digital ground  |
| DRDY/DOUT   | 24      | 28      | Digital output | Dual-purpose output:<br><i>Data ready</i> indicates valid data by going low.<br><i>Data output</i> outputs data, MSB first, on the first rising edge of SCLK.             |
| DVDD        | 1       | 1       | Digital        | Digital power supply: 2.7 V to 5.3 V  |
| GAIN0       | 19      | 23      | Digital input  | Gain select pins. See the <a href="#">Low-Noise PGA</a> section for more information.   |
| GAIN1       | 20      | 24      | Digital input  | Gain select pins. See the <a href="#">Low-Noise PGA</a> section for more information.   |
| REFN        | 15      | 19      | Analog input   | Negative reference input  |
| REFP        | 16      | 20      | Analog input   | Positive reference input  |
| PDWN        | 22      | 26      | Digital input  | Power-down: hold this pin low to power down and reset the ADC. Toggle the pin at device power-up. See the <a href="#">Power-Up Sequence</a> section for more information. |

**表 5-1. Pin Functions (continued)**

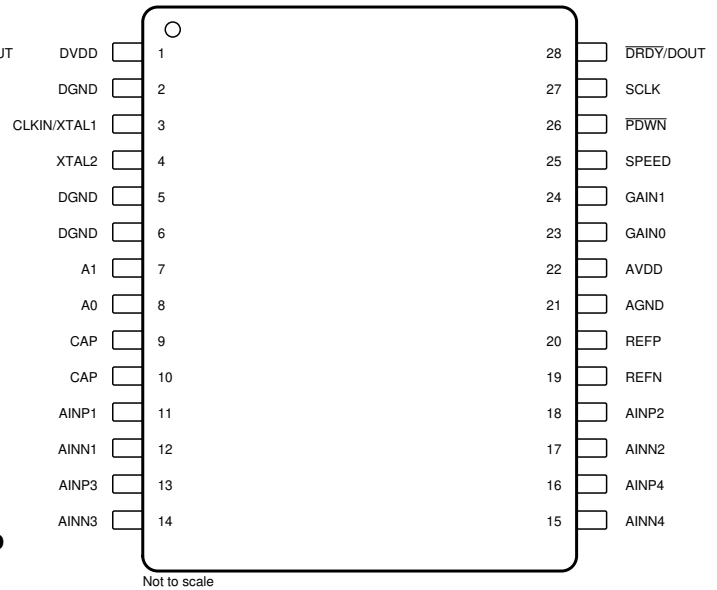
| NAME  | PIN     |         | TYPE          | DESCRIPTION  |
|-------|---------|---------|---------------|--|
|       | ADS1232 | ADS1234 |               |  |
| SCLK  | 23      | 27      | Digital input | Serial clock: clock out data on the rising edge. Also used to initiate offset calibration and standby modes. See the <a href="#">Offset Calibration Mode</a> and <a href="#">Standby Mode With Offset-Calibration</a> sections for more information. |
| SPEED | 21      | 25      | Digital input | Data rate select. See the <a href="#">Data Rate</a> section for more information.  |
| TEMP  | 7       | —       | Digital input | Temperature sensor select. See <a href="#">表 8-1</a> for more information.   |
| XTAL2 | 4       | 4       | Digital       | External crystal connection 2  |

## 6 Specifications

### 6.1 Absolute Maximum Ratings

over operating ambient temperature range (unless otherwise noted)<sup>(1)</sup>

|                       |  | MIN        | MAX        | UNIT |
|-----------------------|--|------------|------------|------|
| Power-supply voltage  | AVDD to AGND   | - 0.3      | 6          | V    |
|                       | DVDD to DGND   | - 0.3      | 6          |      |
|                       | AGND to DGND   | - 0.3      | 0.3        |      |
| Analog input voltage  | AINNx, AINPx, REFP, REFN   | AGND - 0.3 | AVDD + 0.3 | V    |
| Digital input voltage | A0, A1, CLKIN/XTAL1, XTAL2, DRDY/DOUT, GAIN0, GAIN1, PWDN, SCLK, SPEED | DGND - 0.3 | DVDD + 0.3 | V    |
| Input current         | Continuous, all pins except power-supply pins <sup>(2)</sup>           | - 10       | 10         | mA   |
| Temperature           | Junction, T <sub>J</sub>   |            | 150        | °C   |
|                       | Storage, T <sub>stg</sub>  | - 60       | 150        |      |

- (1) Stresses beyond those listed under *Absolute Maximum Ratings* may cause permanent damage to the device. These are stress ratings only, which do not imply functional operation of the device at these or any other conditions beyond those indicated under *Recommended Operating Conditions*. Exposure to absolute-maximum-rated conditions for extended periods may affect device reliability.
- (2) Input and output pins are diode-clamped to the internal power supplies. Limit the input current to 10 mA in the event the analog input voltage exceeds AVDD + 0.3 V or AGND - 0.3 V, or if the digital input voltage exceeds DVDD + 0.3 V or DGND - 0.3 V.

### 6.2 ESD Ratings

|                    |                         |  | VALUE | UNIT |
|--------------------|-------------------------|--|-------|------|
| V <sub>(ESD)</sub> | Electrostatic discharge | Human-body model (HBM), per ANSI/ESDA/JEDEC JS-001 <sup>(1)</sup>              | ±1000 | V    |
|                    |                         | Charged-device model (CDM), per JEDEC specification JESD22-C101 <sup>(2)</sup> | ±500  |      |

- (1) JEDEC document JEP155 states that 500-V HBM allows safe manufacturing with a standard ESD control process.
- (2) JEDEC document JEP157 states that 250-V CDM allows safe manufacturing with a standard ESD control process.

### 6.3 Recommended Operating Conditions

over operating ambient temperature range (unless otherwise noted)

|                                     |                               |                                     | MIN                             | NOM    | MAX                | UNIT |
|-------------------------------------|-------------------------------|-------------------------------------|---------------------------------|--------|--------------------|------|
| <b>POWER SUPPLY</b>                 |                               |                                     |                                 |        |                    |      |
|                                     | Analog power supply           | AVDD to AGND                        | 2.7                             |        | 5.3                | V    |
|                                     | Digital power supply          | DVDD to DGND                        | 2.7                             |        | 5.3                | V    |
| <b>ANALOG INPUTS</b>                |                               |                                     |                                 |        |                    |      |
|                                     | Full-scale input voltage      | $V_{(AINPx)} - V_{(AINNx)}$         | $\pm 0.5 V_{REF} / \text{Gain}$ |        |                    | V    |
|                                     | Common-mode input range       | Gain = 1 and 2                      | AGND - 0.1                      |        | AVDD + 0.1         | V    |
|                                     |                               | Gain = 64 and 128                   | AGND + 1.5                      |        | AVDD - 1.5         |      |
| <b>VOLTAGE REFERENCE INPUTS</b>     |                               |                                     |                                 |        |                    |      |
| $V_{REF}$                           | Voltage reference input       | $V_{REF} = V_{(REFP)} - V_{(REFN)}$ | 1.5                             | AVDD   | AVDD + 0.1         | V    |
| $V_{(REFN)}$                        | Negative reference input      |                                     | AGND - 0.1                      |        | $V_{(REFP)} - 1.5$ | V    |
| $V_{(REFP)}$                        | Positive reference input      |                                     | $V_{(REFN)} + 1.5$              |        | AVDD + 0.1         | V    |
| <b>EXTERNAL CLOCK INPUT</b>         |                               |                                     |                                 |        |                    |      |
| $f_{CLK}$                           | External clock frequency      |                                     | 0.2                             | 4.9152 | 8                  | MHz  |
| <b>SERIAL INTERFACE CLOCK INPUT</b> |                               |                                     |                                 |        |                    |      |
| $f_{(SCLK)}$                        | Serial clock frequency        |                                     |                                 |        | 5                  | MHz  |
| <b>DIGITAL INPUTS</b>               |                               |                                     |                                 |        |                    |      |
|                                     | Input voltage                 |                                     | DGND                            |        | DVDD + 0.1         | V    |
| <b>TEMPERATURE</b>                  |                               |                                     |                                 |        |                    |      |
| $T_A$                               | Operating ambient temperature |                                     | - 40                            |        | 105                | °C   |

### 6.4 Thermal Information

| THERMAL METRIC <sup>(1)</sup> |  | ADS1232    | ADS1234    | UNIT |
|-------------------------------|--|------------|------------|------|
|                               |  | PW (TSSOP) | PW (TSSOP) |      |
|                               |  | 24 PINS    | 28 PINS    |      |
| $R_{\theta JA}$               | Junction-to-ambient thermal resistance       | 82.4       | 74.3       | °C/W |
| $R_{\theta JC(top)}$          | Junction-to-case (top) thermal resistance    | 25.5       | 21.9       | °C/W |
| $R_{\theta JB}$               | Junction-to-board thermal resistance         | 38.1       | 32.9       | °C/W |
| $\psi_{JT}$                   | Junction-to-top characterization parameter   | 1.3        | 1.1        | °C/W |
| $\psi_{JB}$                   | Junction-to-board characterization parameter | 37.6       | 32.4       | °C/W |

(1) For more information about traditional and new thermal metrics, see the [Semiconductor and IC Package Thermal Metrics application report](#).

## 6.5 Electrical Characteristics

minimum and maximum specifications apply from  $T_A = -40^\circ\text{C}$  to  $+105^\circ\text{C}$ ; typical specifications are at  $T_A = 25^\circ\text{C}$ ; all specifications are at  $AVDD = DVDD = V_{(REFP)} = 5\text{ V}$ ,  $V_{(REFN)} = \text{AGND}$ , and  $f_{\text{CLK}} = 4.9152\text{ MHz}$  (unless otherwise noted)

| PARAMETER                      |  | TEST CONDITIONS  | MIN   | TYP      | MAX   | UNIT                    |
|--------------------------------|--|--|---|----------|-------|-------------------------|
| <b>ANALOG INPUTS</b>           |  |  |   |          |       |                         |
|                                | Differential input current                 | Gain = 1   |   | ±3       |       | nA                      |
|                                |  | Gain = 2   |   | ±6       |       |                         |
|                                |  | Gain = 64, 128   |   | ±3.5     |       |                         |
| <b>SYSTEM PERFORMANCE</b>      |  |  |   |          |       |                         |
|                                | Resolution                                 | No missing codes   | 24  |          |       | Bits                    |
| $f_{\text{DATA}}$              | Data rate                                  | Internal oscillator, SPEED = high  | 78  | 80       | 82.4  | SPS                     |
|                                |  | Internal oscillator, SPEED = low   | 9.75  | 10       | 10.3  |                         |
|                                |  | External oscillator, SPEED = high  | $f_{\text{CLK}} / 61,440$                         |          |       |                         |
|                                |  | External oscillator, SPEED = low   | $f_{\text{CLK}} / 491,520$                        |          |       |                         |
|                                | Digital filter settling time               | Full settling, readings synchronized with A0, A1 pins  |   | 4        |       | Conversions             |
| INL                            | Integral nonlinearity                      | Differential input, end-point fit, gain = 1, 2   | - 0.001   | ±0.0002  | 0.001 | % of FSR <sup>(1)</sup> |
|                                |  | Differential input, end-point fit, gain = 64, 128  |   | ±0.0004  |       |                         |
|                                | Input offset error <sup>(2)</sup>          | Gain = 1   | - 5   | ±0.2     | 5     | ppm of FS               |
|                                |  | Gain = 128   | - 1   | ±0.02    | 1     |                         |
|                                | Input offset drift                         | Gain = 1   |   | ±0.3     |       | µV/°C                   |
|                                |  | Gain = 128   |   | ±10      |       | nV/°C                   |
|                                | Gain error <sup>(3)</sup>                  | Gain = 1   | - 0.02  | ±0.001   | 0.02  | %                       |
|                                |  | Gain = 128   | - 0.1   | ±0.01    | 0.1   |                         |
|                                | Gain drift                                 | Gain = 1   |   | ±0.2     |       | ppm/°C                  |
|                                |  | Gain = 128   |   | ±2.5     |       |                         |
| NMRR                           | Normal-mode rejection ratio <sup>(4)</sup> | Internal oscillator, $f_{\text{DATA}} = 10\text{ SPS}$<br>$f_{\text{IN}} = 50\text{ Hz or }60\text{ Hz, } \pm 1\text{ Hz}$ | 100   | 110      |       | dB                      |
|                                |  | External oscillator, $f_{\text{DATA}} = 10\text{ SPS}$<br>$f_{\text{IN}} = 50\text{ Hz or }60\text{ Hz, } \pm 1\text{ Hz}$ | 120   | 130      |       |                         |
| CMRR                           | Common-mode rejection ratio                | At DC, gain = 1, $\Delta V = 1\text{ V}$ , $V_{\text{CM}} = AVDD / 2$  | 95  | 110      |       | dB                      |
|                                |  | At DC, gain = 128, $\Delta V = 0.1\text{ V}$ , $V_{\text{CM}} = AVDD / 2$  | 95  | 110      |       |                         |
| $e_n$                          | Input-referred noise                       |  | See the <a href="#">Noise Performance</a> section |          |       |                         |
| PSRR                           | Power-supply rejection                     | AVDD, at DC, gain = 1, $\Delta V = 1\text{ V}$   |   | 85       |       | dB                      |
|                                |  | AVDD, at DC, gain = 128, $\Delta V = 0.1\text{ V}$   | 100   | 120      |       |                         |
| <b>VOLTAGE REFERENCE INPUT</b> |  |  |   |          |       |                         |
|                                | Input current                              |  |   | 10       |       | nA                      |
| <b>DIGITAL LOGIC LEVELS</b>    |  |  |   |          |       |                         |
| $V_{\text{IH}}$                | High-level input voltage                   |  | 0.7 DVDD  |          |       | V                       |
| $V_{\text{IL}}$                | Low-level input voltage                    |  |   | 0.2 DVDD |       | V                       |
| $V_{\text{OH}}$                | High-level output voltage                  | $I_{\text{OH}} = 1\text{ mA}$  | DVDD - 0.4  |          |       | V                       |
| $V_{\text{OL}}$                | Low-level output voltage                   | $I_{\text{OL}} = 1\text{ mA}$  |   | 0.2 DVDD |       | V                       |
|                                | Input leakage current                      | $0\text{ V} < V_{\text{IN}} < DVDD$  | - 10  |          | 10    | µA                      |



## 6.5 Electrical Characteristics (continued)

minimum and maximum specifications apply from  $T_A = -40^\circ\text{C}$  to  $+105^\circ\text{C}$ ; typical specifications are at  $T_A = 25^\circ\text{C}$ ; all specifications are at  $\text{AVDD} = \text{DVDD} = V_{(\text{REFP})} = 5\text{ V}$ ,  $V_{(\text{REFN})} = \text{AGND}$ , and  $f_{\text{CLK}} = 4.9152\text{ MHz}$  (unless otherwise noted)

| PARAMETER           |                          | TEST CONDITIONS                                | MIN | TYP  | MAX  | UNIT          |
|---------------------|--------------------------|--|-----|------|------|---------------|
| <b>POWER SUPPLY</b> |                          |  |     |      |      |               |
| $I_{(\text{AVDD})}$ | Analog supply current    | Normal mode, AVDD = 3 V, gain = 1, 2           |     | 600  | 1300 | $\mu\text{A}$ |
|                     |                          | Normal mode, AVDD = 3 V, gain = 64, 128        |     | 1350 | 2500 |               |
|                     |                          | Normal mode, AVDD = 5 V, gain = 1, 2           |     | 650  | 1300 |               |
|                     |                          | Normal mode, AVDD = 5 V, gain = 64, 128        |     | 1350 | 2500 |               |
|                     |                          | Standby mode                                   |     | 0.1  | 1    |               |
|                     |                          | Power-down                                     |     | 0.1  | 1    |               |
| $I_{(\text{DVDD})}$ | Digital supply current   | Normal mode, DVDD = 3 V, gain = 1, 2           |     | 60   | 95   | $\mu\text{A}$ |
|                     |                          | Normal mode, DVDD = 3 V, gain = 64, 128        |     | 75   | 120  |               |
|                     |                          | Normal mode, DVDD = 5 V, gain = 1, 2           |     | 95   | 130  |               |
|                     |                          | Normal mode, DVDD = 5 V, gain = 64, 128        |     | 75   | 120  |               |
|                     |                          | Standby mode, SCLK = high, DVDD = 3 V          |     | 45   | 80   |               |
|                     |                          | Standby mode, SCLK = high, DVDD = 5 V          |     | 65   | 80   |               |
|                     |                          | Power-down                                     |     | 0.2  | 1.3  |               |
| $P_D$               | Power dissipation, total | Normal mode, AVDD = DVDD = 3 V, gain = 1, 2    |     | 2    | 4.2  | $\text{mW}$   |
|                     |                          | Normal mode, AVDD = DVDD = 5 V, gain = 1, 2    |     | 3.7  | 7.2  |               |
|                     |                          | Normal mode, AVDD = DVDD = 3 V, gain = 64, 128 |     | 4.3  | 7.9  |               |
|                     |                          | Normal mode, AVDD = DVDD = 5 V, gain = 64, 128 |     | 7.1  | 13.1 |               |
|                     |                          | Standby mode, AVDD = DVDD = 5 V                |     | 0.3  | 0.4  |               |

- (1) FSR = full-scale range =  $V_{\text{REF}} / \text{Gain}$ .
- (2) Input offset error specified after calibration. Recalibration minimizes these errors to the level of noise at any temperature.
- (3) Gain errors are calibrated at the factory (AVDD = 5 V, all gains,  $T_A = 25^\circ\text{C}$ ).
- (4) Specification is assured by the combination of design and final production test.

## 6.6 Typical Characteristics

at  $T_A = 25^\circ\text{C}$ ,  $AVDD = DVDD = V_{(REFP)} = 5\text{ V}$ , and  $V_{(REFN)} = \text{AGND}$  (unless otherwise noted)



图 6-1. Noise Plot



图 6-2. Noise Plot

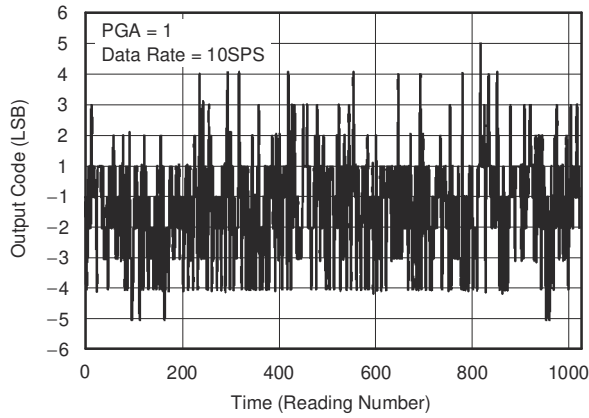

图 6-3. Noise Histogram

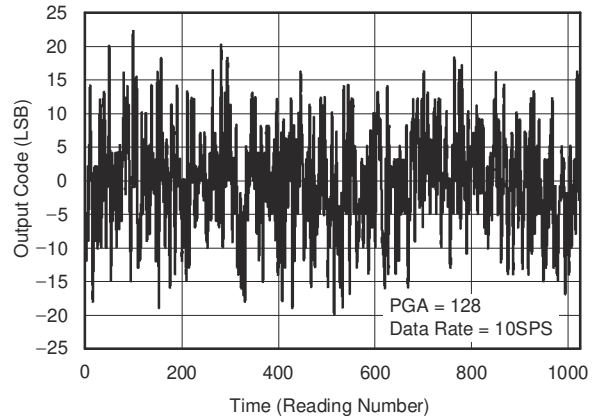

图 6-4. Noise Histogram

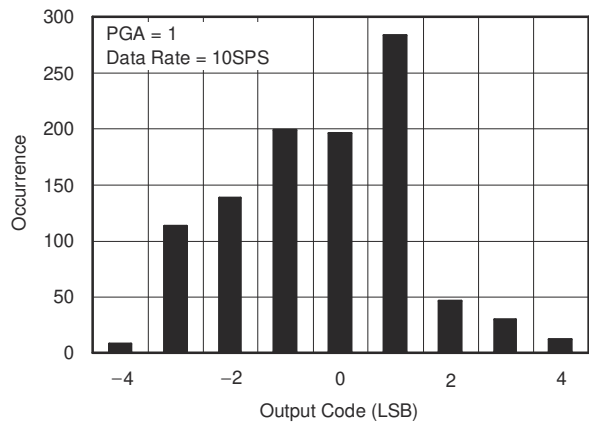

图 6-5. Noise Plot

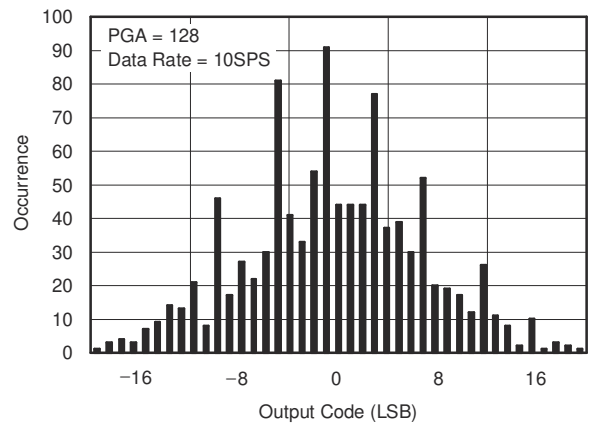

图 6-6. Noise Plot

## 6.6 Typical Characteristics (continued)

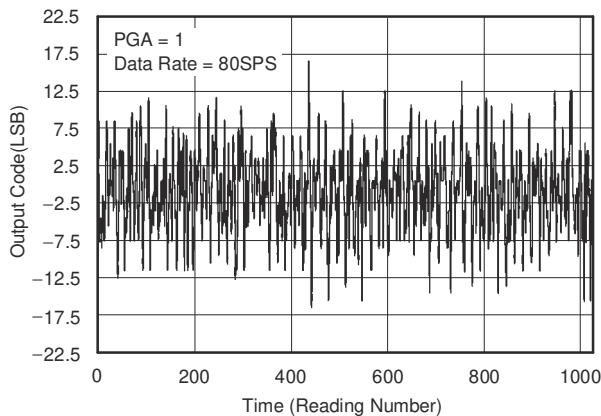
at  $T_A = 25^\circ\text{C}$ ,  $AVDD = DVDD = V_{(REFP)} = 5\text{ V}$ , and  $V_{(REFN)} = \text{AGND}$  (unless otherwise noted)

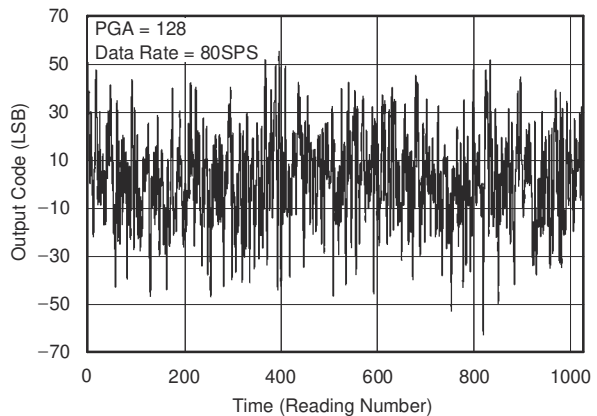

图 6-7. Noise Histogram



图 6-8. Noise Histogram

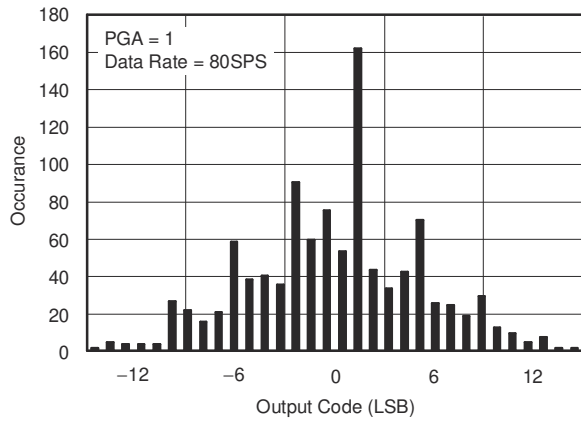

图 6-9. Offset Drift (-40°C to +25°C)

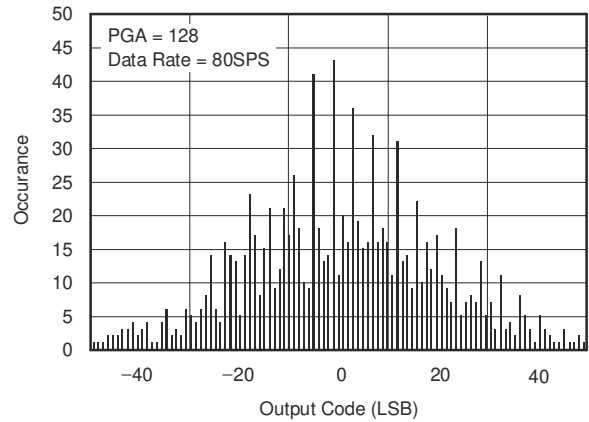

图 6-10. Offset Drift (25°C to 105°C)

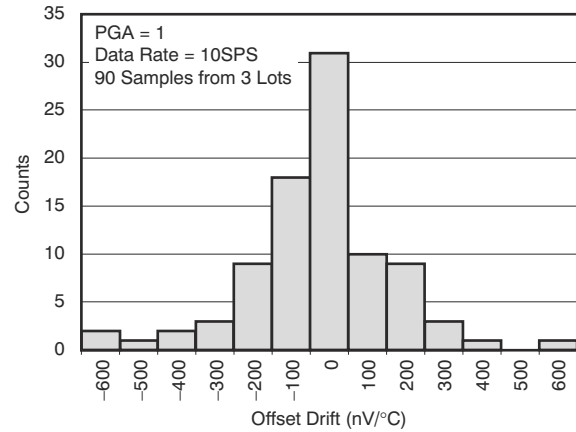

图 6-11. Gain Drift (-40°C to +25°C)

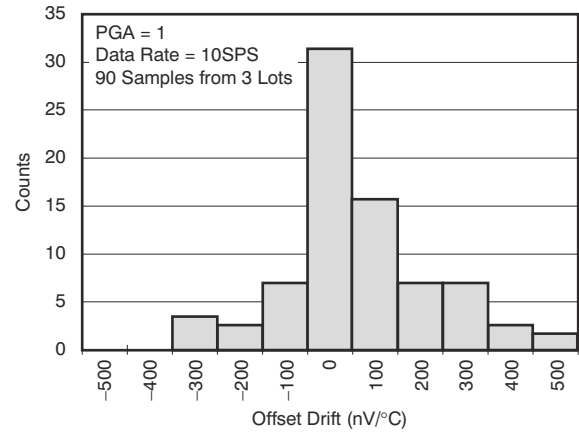

图 6-12. Gain Drift (25°C to 105°C)

## 6.6 Typical Characteristics (continued)

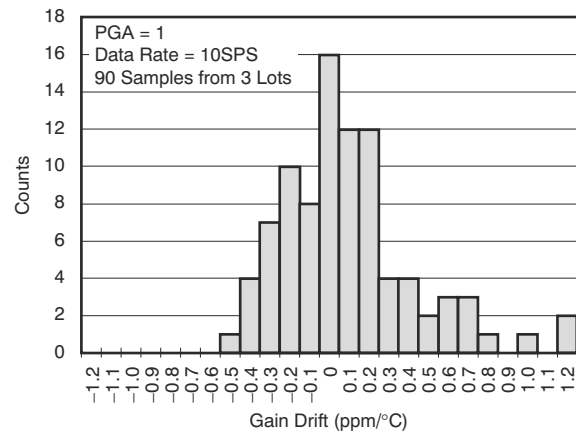
at  $T_A = 25^\circ\text{C}$ ,  $AVDD = DVDD = V_{(REFP)} = 5\text{ V}$ , and  $V_{(REFN)} = \text{AGND}$  (unless otherwise noted)

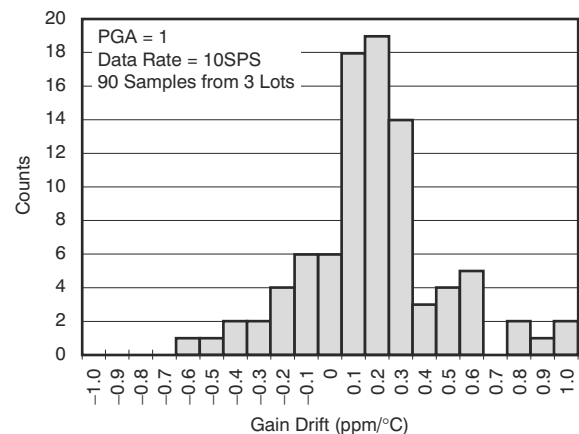

图 6-13. Offset Drift (-40°C to +25°C)



图 6-14. Offset Drift (25°C to 105°C)

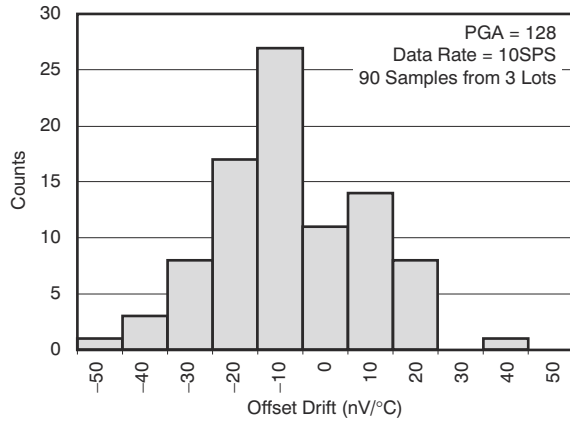

图 6-15. Gain Drift (-40°C to +25°C)

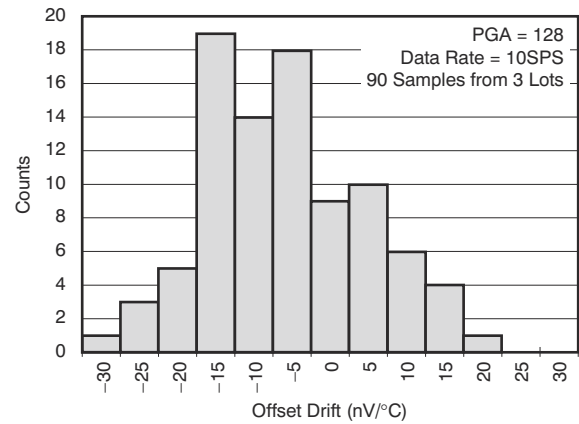

图 6-16. Gain Drift (25°C to 105°C)

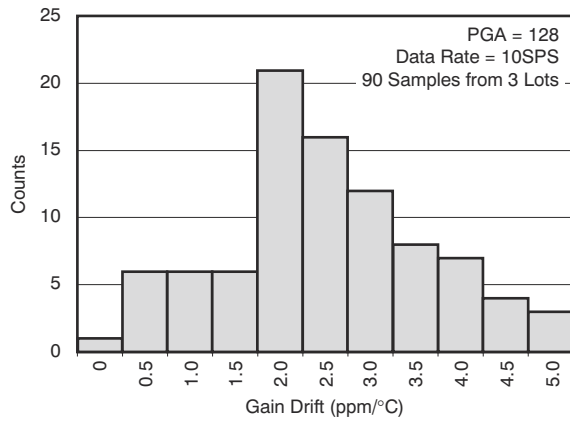

图 6-17. Offset vs Temperature

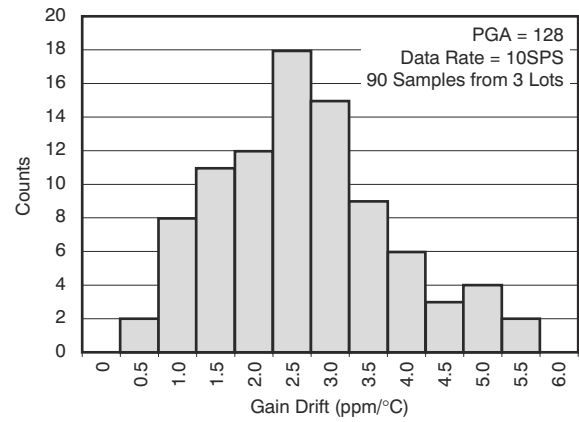

图 6-18. Gain Error vs Temperature

## 6.6 Typical Characteristics (continued)

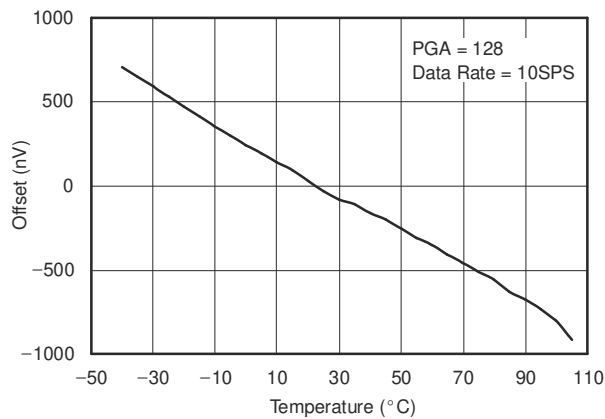
at  $T_A = 25^\circ\text{C}$ ,  $AVDD = DVDD = V_{(REFP)} = 5\text{ V}$ , and  $V_{(REFN)} = \text{AGND}$  (unless otherwise noted)

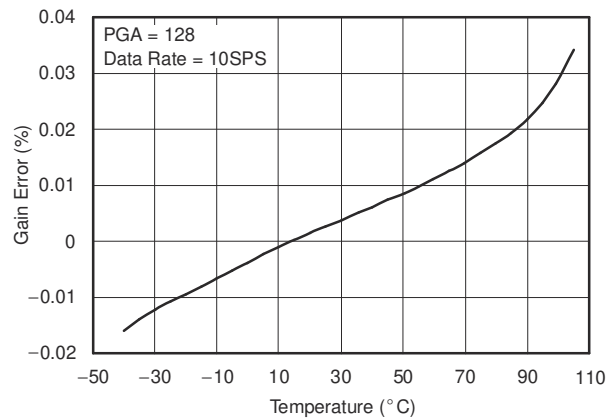

图 6-19. Noise vs Input Signal



图 6-20. Noise vs Input Signal

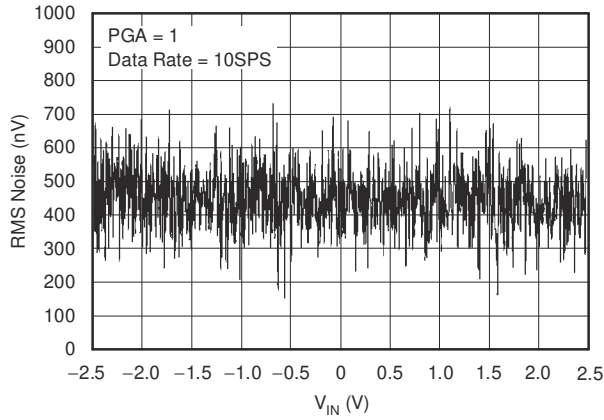

图 6-21. Integral Nonlinearity vs Input Signal

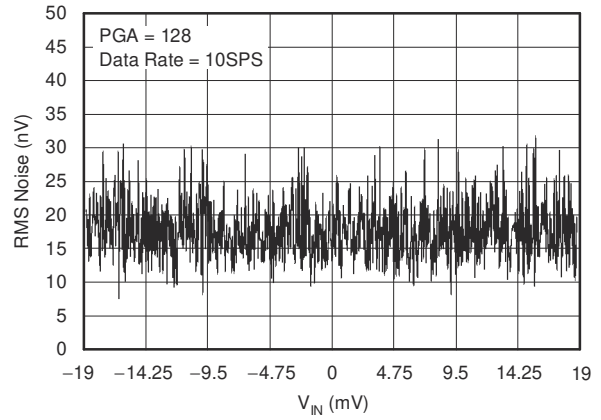

图 6-22. Integral Nonlinearity vs Input Signal

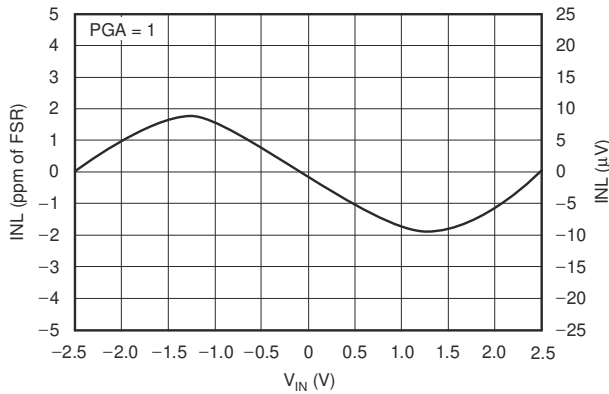

图 6-23. Analog Supply Current vs Temperature

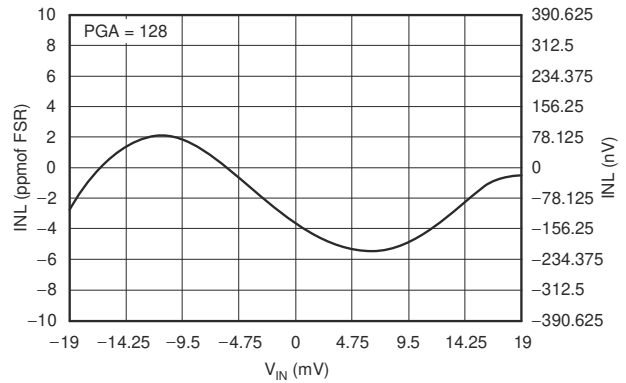

图 6-24. Digital Supply Current vs Temperature

### 6.6 Typical Characteristics (continued)

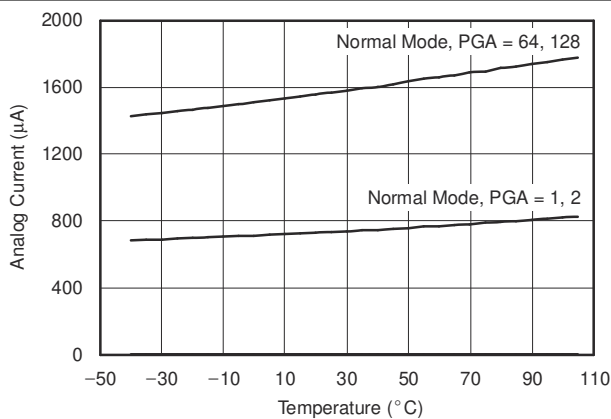
at  $T_A = 25^\circ\text{C}$ ,  $AVDD = DVDD = V_{(REFP)} = 5\text{ V}$ , and  $V_{(REFN)} = \text{AGND}$  (unless otherwise noted)

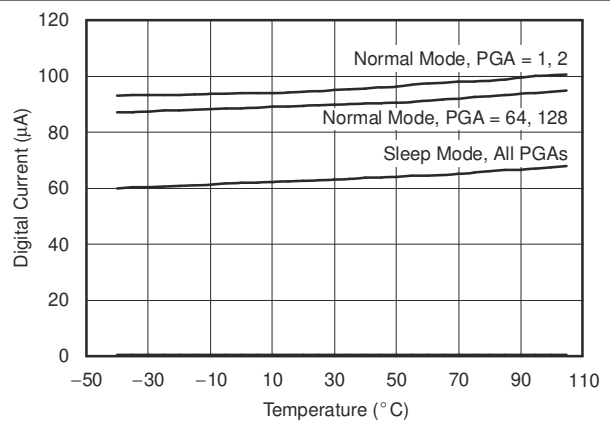

图 6-25. Data Rate vs Temperature

## 7 Parameter Measurement Information

### 7.1 Noise Performance

The ADS123x offer outstanding noise performance that can be optimized for a given full-scale range using the programmable gain amplifier (PGA). 表 7-1 through 表 7-4 summarize the typical noise performance with inputs shorted externally for different gains, data rates, and voltage reference values. The RMS and peak-to-peak noise data are referred to the input.

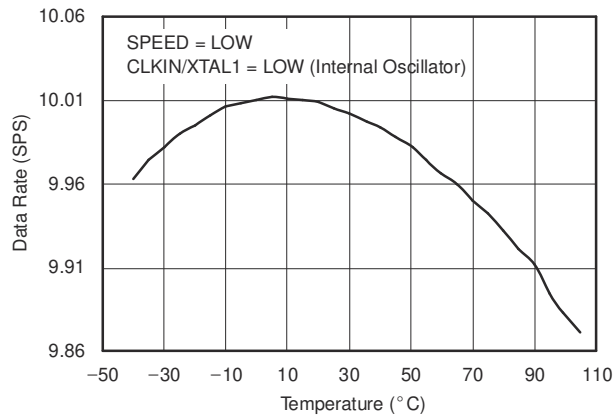
The effective resolution of the ADC is defined as:

$$\text{Effective Resolution (Bits)} = \ln(\text{FSR} / \text{RMS Noise}) / \ln(2) \quad (1)$$

The noise-free resolution of the ADC is defined as:

$$\text{Noise-Free Resolution (Bits)} = \ln(\text{FSR} / \text{Peak-to-Peak Noise}) / \ln(2) \quad (2)$$

where

- FSR = full-scale range =  $V_{\text{REF}} / \text{gain}$

**表 7-1. AVDD = 5 V, V<sub>REF</sub> = 5 V, Data Rate = 10 SPS**

| GAIN | RMS NOISE | PEAK-TO-PEAK NOISE <sup>(1)</sup> | EFFECTIVE RESOLUTION (Bits) | NOISE-FREE RESOLUTION (Bits) |
|------|-----------|-----------------------------------|-----------------------------|------------------------------|
| 1    | 420 nV    | 1.79 μV                           | 23.5                        | 21.4                         |
| 2    | 270 nV    | 900 nV                            | 23.1                        | 21.4                         |
| 64   | 19 nV     | 125 nV                            | 22.0                        | 19.2                         |
| 128  | 17 nV     | 110 nV                            | 21.1                        | 18.4                         |

(1) Peak-to-peak noise data are based on direct measurement.

**表 7-2. AVDD = 5 V, V<sub>REF</sub> = 5 V, Data Rate = 80 SPS**

| GAIN | RMS NOISE | PEAK-TO-PEAK NOISE <sup>(1)</sup> | EFFECTIVE RESOLUTION (Bits) | NOISE-FREE RESOLUTION (Bits) |
|------|-----------|-----------------------------------|-----------------------------|------------------------------|
| 1    | 1.36 μV   | 8.3 μV                            | 21.8                        | 19.2                         |
| 2    | 850 nV    | 5.5 μV                            | 21.5                        | 18.8                         |
| 64   | 48 nV     | 307 nV                            | 20.6                        | 18                           |
| 128  | 44 nV     | 247 nV                            | 19.7                        | 17.2                         |

(1) Peak-to-peak noise data are based on direct measurement.

**表 7-3. AVDD = 3 V, V<sub>REF</sub> = 3 V, Data Rate = 10 SPS**

| GAIN | RMS NOISE | PEAK-TO-PEAK NOISE <sup>(1)</sup> | EFFECTIVE RESOLUTION (Bits) | NOISE-FREE RESOLUTION (Bits) |
|------|-----------|-----------------------------------|-----------------------------|------------------------------|
| 1    | 450 nV    | 2.8 μV                            | 22.6                        | 20                           |
| 2    | 325 nV    | 1.8 μV                            | 22.1                        | 19.7                         |
| 64   | 20 nV     | 130 nV                            | 21.2                        | 18.5                         |
| 128  | 18 nV     | 115 nV                            | 20.3                        | 17.6                         |

(1) Peak-to-peak noise data are based on direct measurement.

**表 7-4. AVDD = 3 V, V<sub>REF</sub> = 3 V, Data Rate = 80 SPS**

| GAIN | RMS NOISE | PEAK-TO-PEAK NOISE <sup>(1)</sup> | EFFECTIVE RESOLUTION (Bits) | NOISE-FREE RESOLUTION (Bits) |
|------|-----------|-----------------------------------|-----------------------------|------------------------------|
| 1    | 2.2 μV    | 12 μV                             | 20.4                        | 17.9                         |
| 2    | 1.2 μV    | 6.8 μV                            | 20.2                        | 17.8                         |
| 64   | 54 nV     | 340 nV                            | 19.7                        | 17.1                         |
| 128  | 48 nV     | 254 nV                            | 18.9                        | 16.5                         |

(1) Peak-to-peak noise data are based on direct measurement of 1024 samples.

## 8 Detailed Description

### 8.1 Overview

The ADS1232 and ADS1234 (ADS123x) are highly integrated, 24-bit ADCs that include an input multiplexer, low-noise PGA, third-order delta-sigma ( $\Delta \Sigma$ ) modulator, and fourth-order digital filter. With input-referred RMS noise down to 17 nV, the ADS123x are ideally suited for measuring the very low signals produced by bridge sensors in applications such as weigh scales, strain gauges, and pressure sensors.

Clocking can be supplied by an external oscillator, an external crystal, or by a precision internal oscillator. Data can be output at 10 SPS for excellent 50-Hz and 60-Hz rejection, or at 80 SPS when higher speeds are needed. The ADS123x are easy to configure, and all digital control is accomplished through dedicated pins; there are no registers to program. A simple two-wire serial interface retrieves the data.

### 8.2 Functional Block Diagram

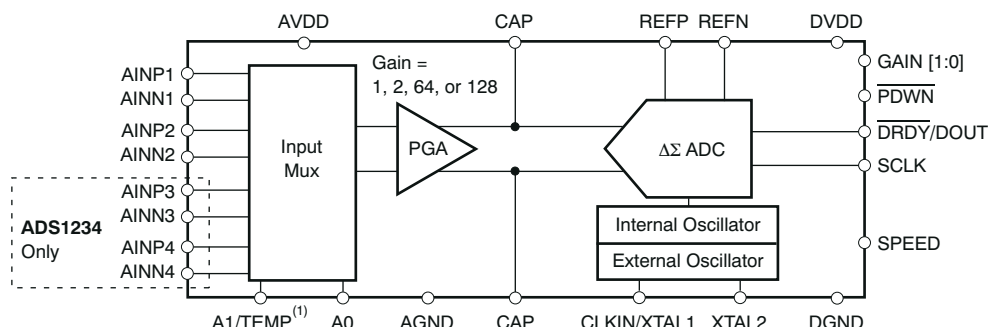

NOTE: (1) A1 for ADS1234, TEMP for ADS1232.

### 8.3 Feature Description

#### 8.3.1 Analog Inputs (AINPX, AINNX)

The input signal to be measured is applied to the input pins AINPx and AINNx. The positive internal input is generalized as AINP, and the negative internal input generalized as AINN. The signal is selected through the input MUX, which is controlled by pins A0 and TEMP (ADS1232) and pins A0 and A1 (ADS1234), as shown in [表 8-1](#) and [表 8-2](#).

The ADS123x accept differential input signals, but can also accept single-ended signals. When measuring single-ended signals, it is permissible to connect the negative input (AINNx) to ground only for gain = 1 or 2. When using gain = 64 or 128, connect AINNx to a level-shift voltage equal to mid-AVDD supply to comply with the input range requirement. Connect the signal to the positive input (AINPx). When the ADS123x are configured this way, only half of the converter full-scale range is used because only positive digital output codes are produced.

The analog and reference inputs are protected by ESD diodes. See [图 8-3](#) for the similar connection of the ESD diodes for the analog inputs.

表 8-1. ADS1232 Input Channel Selection With A0 and TEMP

| MUX PINS |    | SELECTED ANALOG INPUTS |                    |
|----------|----|------------------------|--------------------|
| TEMP     | A0 | POSITIVE INPUT         | NEGATIVE INPUT     |
| 0        | 0  | AINP1                  | AINN1              |
| 0        | 1  | AINP2                  | AINN2              |
| 1        | x  | Temperature sensor     | Temperature sensor |



表 8-2. ADS1234 Input Channel Selection With A0 and A1

| MUX PINS |    | SELECTED ANALOG INPUTS |                |
|----------|----|------------------------|----------------|
| A1       | A0 | POSITIVE INPUT         | NEGATIVE INPUT |
| 0        | 0  | AINP1                  | AINN1          |
| 0        | 1  | AINP2                  | AINN2          |
| 1        | 0  | AINP3                  | AINN3          |
| 1        | 1  | AINP4                  | AINN3          |

### 8.3.2 Temperature Sensor (ADS1232 Only)

On-chip diodes provide temperature-sensing capability. By setting the TEMP pin high, the selected analog inputs are disconnected and the inputs to the ADC are connected to the anodes of two diodes scaled to 1x and 80x in current and size, as shown in 图 8-1. By measuring the difference in voltage of these diodes, temperature changes can be inferred from a baseline temperature. Typically, the difference in diode voltage is 111.7 mV at 25°C with a temperature coefficient of 379  $\mu\text{V}/^\circ\text{C}$ . With PGA gain = 1 and 2, the difference voltage output from the PGA is 111.7 mV and 223.4 mV, respectively. The temperature sensor function is impossible to use with PGA gain = 64 and 128.



图 8-1. Measurement of the Temperature Sensor in the Input Multiplexer

### 8.3.3 Low-Noise PGA

The ADS123x feature a low-drift, low-noise PGA that provides a complete front-end solution for bridge sensors. A simplified diagram of the PGA is shown in 图 8-2. The PGA consists of two chopper-stabilized amplifiers (A1 and A2) and three accurately matched resistors ( $R_1$ ,  $R_{F1}$ , and  $R_{F2}$ ), which construct a differential front-end stage with a gain of 64, followed by gain stage A3. The PGA inputs are equipped with an EMI filter, as shown in 图 8-2. The cut-off frequency of the EMI filter is 19.6 MHz. If the PGA gain is set to 1 or 2, the gain-of-64 stage is bypassed and shut down to save power. With the combination of both gain stages, the PGA gain can be set to 64 or 128. The PGA gain of the ADS123x is set to 1, 2, 64, or 128 by pins GAIN1 (MSB) and GAIN0 (LSB). 表 8-3 shows the gain setting of the PGA.

表 8-3. PGA Gain

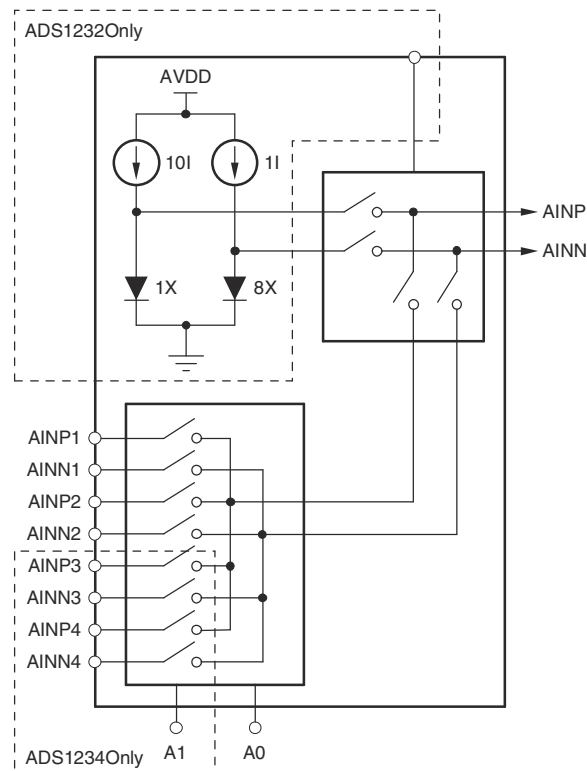
| GAIN[1:0] INPUT PINS | PGA GAIN |
|----------------------|----------|
| 00                   | 1        |
| 01                   | 2        |
| 10                   | 64       |
| 11                   | 128      |

By using AVDD as the reference input, the bipolar input ranges from  $\pm 2.5$  V to  $\pm 19.5$  mV, while the unipolar ranges from 2.5 V to 19.5 mV. When the PGA gain is set to 1 or 2, the absolute inputs can go rail-to-rail without significant performance degradation. However, the inputs of the ADS123x are protected with internal diodes connected to the power-supply rails. These diodes clamp the applied signal to prevent damage to the input circuitry. On the other hand, when the PGA gain is set to 64 or 128, the operating input range is limited to (AGND + 1.5 V) to (AVDD - 1.5 V), in order to prevent saturating the differential front-end circuitry and degrading performance.



图 8-2. Simplified Diagram of the PGA

#### 8.3.3.1 PGA Bypass Capacitor

By applying a 0.1- $\mu$ F external capacitor ( $C_{EXT}$ ) across two PGA output pins (pins 9 and 10) and the combination of the internal 2-k $\Omega$  resistor ( $R_{INT}$ ), a low-pass filter, with a corner frequency of 720 Hz, is created to band limit the signal path prior to the modulator input. This low-pass filter serves two purposes. First, the input signal is band-limited to prevent aliasing, as well as to filter high-frequency noise. Second, the low-pass filter attenuates the chopping residue from the PGA (for gains of 64 and 128 only) to improve temperature drift performance. High-quality capacitors (such as high-k ceramic or tantalum capacitors) are not required for a general application. However, high-quality capacitors, such as C0G dielectric ceramic or poly, are recommended for high-linearity applications.

### 8.3.4 Voltage Reference Inputs (REFP, REFN)

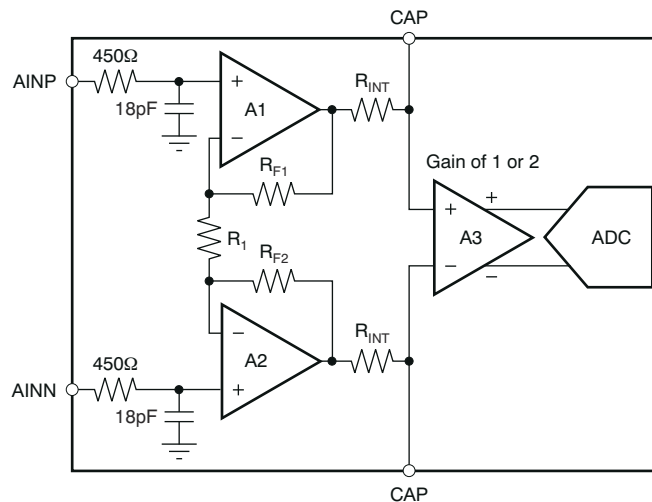
The voltage reference used by the modulator is generated from the voltage difference between pins REFP and REFN:  $V_{REF} = V_{(REFP)} - V_{(REFN)}$ . The reference inputs use a structure similar to that of the analog inputs. In order to increase the reference input impedance, a switching buffer circuitry is used to reduce the input equivalent capacitance. The reference drift and noise impact ADC performance. In order to achieve best results, pay close attention to the reference noise and drift specifications. A simplified diagram of the circuitry on the reference inputs is shown in 图 8-3. The switches and capacitors can be modeled with an effective impedance of:

$$Z_{EFF} = \frac{1}{2f_{MOD}C_{BUF}}$$

where

- $f_{MOD}$  = modulator sampling frequency =  $f_{CLK} / 64 = (76.8 \text{ kHz})$
- $C_{BUF}$  = input capacitance of the buffer

For the ADS123x:

$$Z_{EFF} = \frac{1}{(2)(76.8\text{kHz})(13\text{fF})} = 500\text{M}\Omega$$



图 8-3. Simplified Reference Input Circuitry

ESD diodes protect the reference inputs. To prevent these diodes from turning on, make sure the voltages on the reference pins do not go below AGND by more than 100 mV; and likewise, do not exceed AVDD by 100 mV:

$$\text{AGND} - 100 \text{ mV} < V_{(REFP)} \text{ or } V_{(REFN)} < \text{AVDD} + 100 \text{ mV}$$

### 8.3.5 Clock Sources

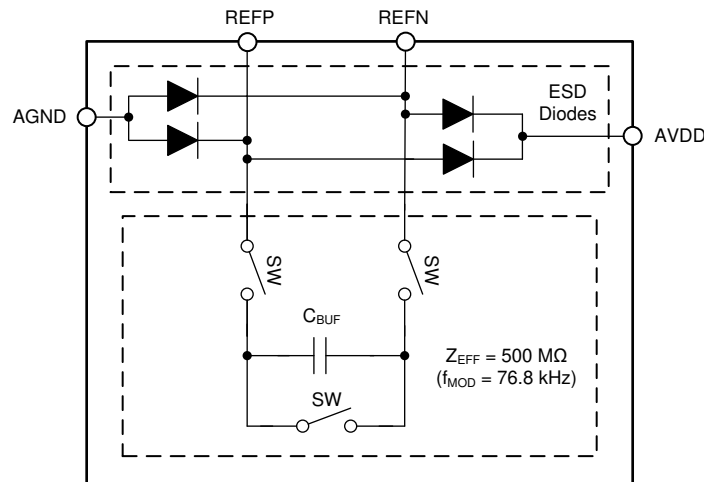
The ADS123x can use an external clock source, external crystal, or internal oscillator to accommodate a wide variety of applications. 图 8-4 shows the equivalent circuitry of the clock source. The CLK\_DETECT block determines whether a crystal oscillator or external clock signal is applied to the CLKIN/XTAL1 pin so that the internal oscillator is bypassed or activated. When the CLKIN/XTAL1 pin frequency is above approximately 200 kHz, the CLK\_DETECT output goes low and shuts down the internal oscillator. When the CLKIN/XTAL1 pin frequency is below approximately 200 kHz, the CLK\_DETECT output goes high and activates the internal oscillator. Connect the CLKIN/XTAL1 pin to ground when the internal oscillator is chosen.



图 8-4. Equivalent Circuitry of the Clock Source

For crystal operation, connect the 4.9152-MHz crystal across the CLKIN/XTAL1 and XTAL2 pins. 表 8-4 shows the recommended crystal part numbers. As a result of the low-power design of the internal parallel-resonant circuit, both the CLKIN/XTAL1 and XTAL2 pins are only for use with the external crystal; do not use these pins as clock output drivers for external circuitry. No external capacitors are used with the crystal. Place the crystal as close as possible to the device pins in order to reduce board stray capacitance and in order to help ensure proper crystal operation.

表 8-4. Recommended Crystals

| MANUFACTURER | FREQUENCY  | PART NUMBER |
|--------------|------------|-------------|
| ECS          | 4.9152 MHz | ECS-49-20-1 |
| ECS          | 4.9152 MHz | ECS-49-20-4 |

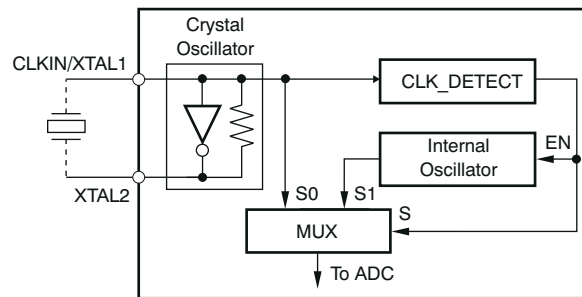
An external clock oscillator can be used by driving the CLKIN/XTAL1 pin from the oscillator output and leave XTAL2 disconnected.

### 8.3.6 Digital Filter Frequency Response

The ADS123x use a sinc<sup>4</sup> digital filter with the frequency response ( $f_{CLK} = 4.9152\text{ MHz}$ ) shown in 图 8-5. The frequency response repeats at multiples of the modulator sampling frequency of 76.8 kHz. The overall response is that of a low-pass filter with a -3-dB cutoff frequency of 2.4 Hz with the SPEED pin tied low (10-SPS data rate) and 19 Hz with the SPEED pin tied high (80-SPS data rate).



图 8-5. Digital Filter Frequency Response

To better demonstrate the response at lower frequencies, 图 8-6(a) illustrates the response out to 100 Hz, when the data rate = 10 SPS. Notice that signals at multiples of 10 Hz are rejected, and therefore, simultaneous rejection of 50 Hz and 60 Hz interference is achieved.

The benefit of using a sinc<sup>4</sup> filter is that every frequency notch has four zeros at the same location. This response, combined with the low-drift internal oscillator, provides an excellent normal-mode rejection of line-cycle interference.

图 8-6(b) shows the plot enlarged for both 50-Hz and 60-Hz notches with the SPEED pin tied low (10-SPS data rate). With only a  $\pm 3\%$  variation of the internal oscillator, over 100 dB of normal-mode rejection is achieved.

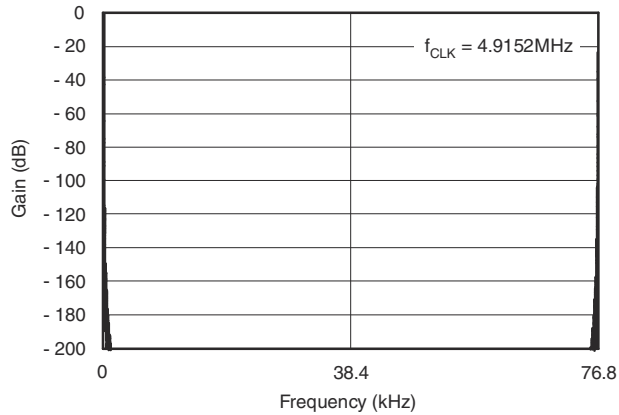

图 8-6. Digital Filter Frequency Response to 100 Hz

The ADS123x data rate and frequency response scale directly with clock frequency. For example, if  $f_{CLK}$  increases from 4.9152 MHz to 6.144 MHz when the SPEED pin is tied high, the data rate increases from 80 SPS to 100 SPS, while filter notches also increase from 80 Hz to 100 Hz. Frequency scaling is only possible when the external clock source is applied.

### 8.3.7 Settling Time

After changing the input multiplexer, the first data are fully settled. In both ADS123x devices, the digital filter is allowed to settle after toggling either the A1 or A0 pin. Toggling any of these digital pins holds the  $\overline{\text{DRDY}}/\text{DOUT}$  line high until the digital filter is fully settled. For example, if A0 changes from low to high, selecting a different input channel,  $\overline{\text{DRDY}}/\text{DOUT}$  immediately goes high, and  $\overline{\text{DRDY}}/\text{DOUT}$  goes low when fully settled data are ready for retrieval. There is no need to discard any data. 图 8-7 shows the timing of the  $\overline{\text{DRDY}}/\text{DOUT}$  line as the input multiplexer changes.

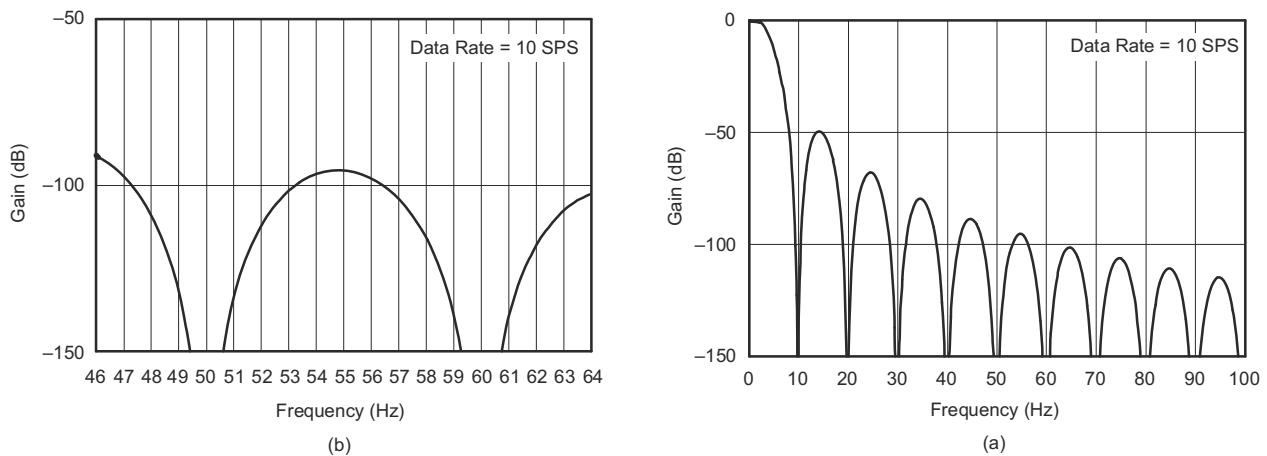
In certain instances, large or abrupt input changes require four data cycles to settle. One example of such a change is an external multiplexer in front of the ADS123x, which can cause large changes in input voltage simply by switching input channels. Another example is toggling the TEMP pin, which switches the internal AINP, AINN signals to connect to either the external AINPx, AINNx pins or to the TEMP diode (see 图 8-1).

To acquire fully settled data after an input step change, five readings are required. Five readings are required because if the change in input occurs in the middle of the first conversion, four additional full conversions of the fully settled input are required to get fully settled data. Discard the first four readings because they contain only partially settled data. 图 8-8 illustrates the settling time for the ADS123x in continuous conversion mode.



图 8-7. Example of Settling Time After Changing the Input Multiplexer

表 8-5. Timing Requirements for 图 8-7

| PARAMETER <sup>(1)</sup> |   | MIN       | MAX | UNIT    |
|--------------------------|---|-----------|-----|---------|
| $t_s$                    | Setup time for changing the A1 or A0 pins                       | 40        | 50  | $\mu s$ |
| $t_1$                    | Settling time ( $\overline{\text{DRDY}}/\text{DOUT}$ held high) | SPEED = 1 | 51  | ms      |
|                          |   | SPEED = 0 | 401 | ms      |

(1) Values given for  $f_{\text{CLK}} = 4.9152 \text{ MHz}$ . For different  $f_{\text{CLK}}$  frequencies, scale proportional to CLK period. Expect a  $\pm 3\%$  variation when an internal oscillator is used.

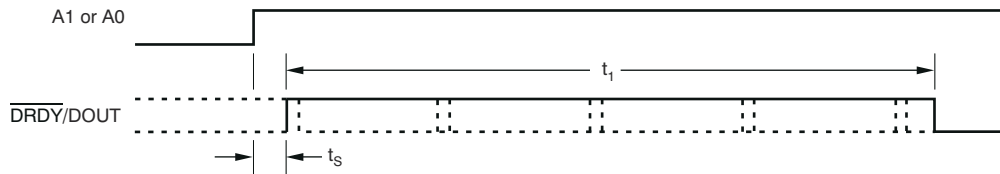

图 8-8. Settling Time in Continuous Conversion Mode

### 8.3.8 Data Rate

The ADS123x data rate is set by the SPEED pin, as shown in 表 8-6. When SPEED is low, the data rate is nominally 10 SPS. This data rate provides the lowest noise, and also has excellent rejection of both 50-Hz and 60-Hz line-cycle interference. For applications requiring fast data rates, setting SPEED high selects a data rate of 80 SPS.

表 8-6. Data Rate Settings

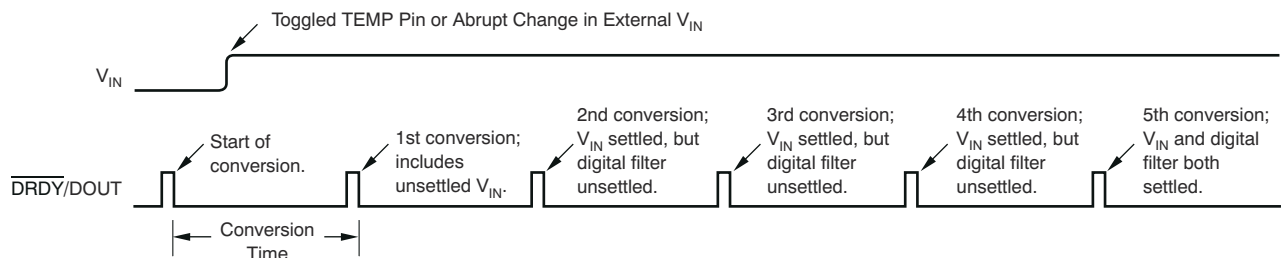
| SPEED<br>PIN | DATA RATE                                    |                            |
|--------------|--|----------------------------|
|              | INTERNAL OSCILLATOR<br>OR 4.9152-MHz CRYSTAL | EXTERNAL<br>OSCILLATOR     |
| 0            | 10 SPS                                       | $f_{\text{CLK}} / 491,520$ |
| 1            | 80 SPS                                       | $f_{\text{CLK}} / 61,440$  |

### 8.3.9 Data Format

The ADS123x output 24 bits of data in binary two's complement format. The least significant bit (LSB) has a weight of  $0.5 V_{\text{REF}} / (2^{23} - 1)$ . The positive full-scale input produces an output code of 7FFFFFFh and the negative full-scale input produces an output code of 800000h. The output clips at these codes for signals exceeding full-scale. 表 8-7 summarizes the ideal output codes for different input signals.

表 8-7. Ideal Output Code Versus Input Signal<sup>(1)</sup>

| INPUT SIGNAL $V_{\text{IN}}$<br>(AINP - AINN)        | IDEAL OUTPUT CODE |
|--|-------------------|
| $\geq 0.5 V_{\text{REF}} / \text{Gain}$              | 7FFFFFFh          |
| $(0.5 V_{\text{REF}} / \text{Gain}) / (2^{23} - 1)$  | 000001h           |
| 0  | 000000h           |
| $(-0.5 V_{\text{REF}} / \text{Gain}) / (2^{23} - 1)$ | FFFFFFh           |
| $\leq -0.5 V_{\text{REF}} / \text{Gain}$             | 800000h           |

(1) Excludes effects of noise, INL, offset, and gain errors.

### 8.3.10 Data Ready and Data Output ( $\overline{\text{DRDY}}/\text{DOUT}$ )

This digital output pin serves two purposes. First,  $\overline{\text{DRDY}}/\text{DOUT}$  indicates when new data are ready by going low. Afterwards, on the first rising edge of SCLK, the  $\overline{\text{DRDY}}/\text{DOUT}$  pin changes function and begins outputting the conversion data, most significant bit (MSB) first. Data are shifted out on each subsequent SCLK rising edge. After all 24 bits have been retrieved, the pin can be forced high with an additional SCLK.  $\overline{\text{DRDY}}/\text{DOUT}$  then remains high until new data are ready. This configuration is useful when polling on the status of  $\overline{\text{DRDY}}/\text{DOUT}$  to determine when to begin data retrieval.

### 8.3.11 Serial Clock Input (SCLK)

This digital input shifts serial data out with each rising edge. This input has built-in hysteresis, but care must be taken to ensure a clean signal. Glitches or slow-rising signals can cause unwanted additional shifting. For this reason, make sure the rise-and-fall times of SCLK are less than 50 ns.

### 8.3.12 Data Retrieval

The ADS123x continuously converts the analog input signal. To retrieve data, wait until  $\overline{\text{DRDY}}/\text{DOUT}$  goes low, as shown in [图 8-9](#). After  $\overline{\text{DRDY}}/\text{DOUT}$  goes low, begin shifting out the data by applying SCLKs. Data are shifted out MSB first. Not all 24 bits of data are required to be shifted out, but the data must be retrieved before new data are updated (within  $t_7$ ) or else the data are overwritten. Avoid data retrieval during the update period ( $t_6$ ).  $\overline{\text{DRDY}}/\text{DOUT}$  remains at the state of the last bit shifted out until taken high (see  $t_6$ ), indicating that new data are being updated. To avoid having  $\overline{\text{DRDY}}/\text{DOUT}$  remain in the state of the last bit, the user can shift SCLK to force  $\overline{\text{DRDY}}/\text{DOUT}$  high, as shown in [图 8-10](#). This technique is useful when a host controlling the device is polling  $\overline{\text{DRDY}}/\text{DOUT}$  to determine when data are ready.



图 8-9. Data Retrieval Timing

表 8-8. Timing Requirements for [图 8-9](#)

| PARAMETER |  | MIN       | TYP  | MAX | UNIT          |
|-----------|--|-----------|------|-----|---------------|
| $t_2$     | $\overline{\text{DRDY}}/\text{DOUT}$ low to first SCLK rising edge | 0         |      |     | ns            |
| $t_3$     | SCLK positive or negative pulse width                              | 100       |      |     | ns            |
| $t_4$     | SCLK rising edge to new data bit valid: propagation delay          |           |      | 50  | ns            |
| $t_5$     | SCLK rising edge to old data bit valid: hold time                  | 0         |      |     | ns            |
| $t_6$ (1) | Data updating: no readback allowed                                 | 39        |      |     | $\mu\text{s}$ |
| $t_7$ (1) | Conversion time (1/data rate)                                      | SPEED = 1 | 12.5 |     | ms            |
|           |  | SPEED = 0 | 100  |     |               |

(1) Values given for  $f_{\text{CLK}} = 4.9152 \text{ MHz}$ . For different  $f_{\text{CLK}}$  frequencies, scale proportional to the CLK period.

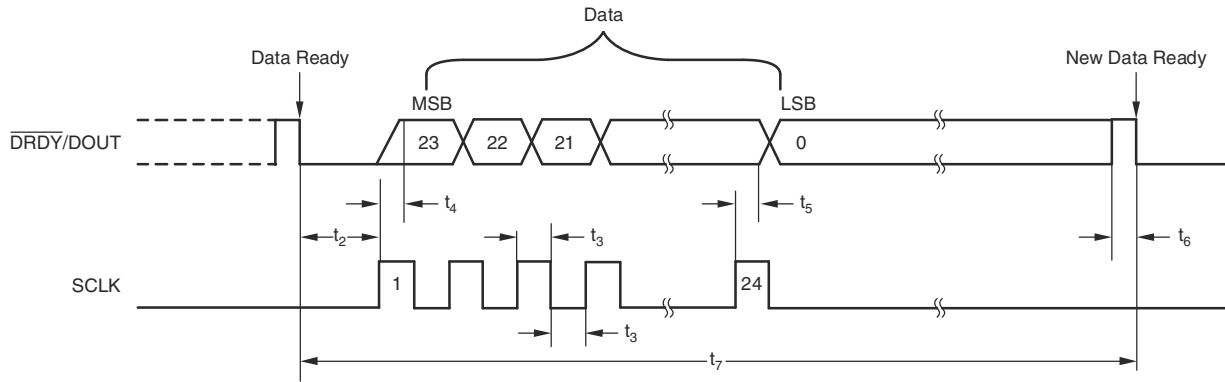

图 8-10. Data Retrieval With  $\overline{\text{DRDY}}/\text{DOUT}$  Forced High Afterwards



## 8.4 Device Functional Modes

In addition to the active conversion mode, the device has other functional modes: offset calibration mode (to calibrate the ADC internal offset), standby mode (saving power when not converting), and a power-down mode (for complete device shutdown).

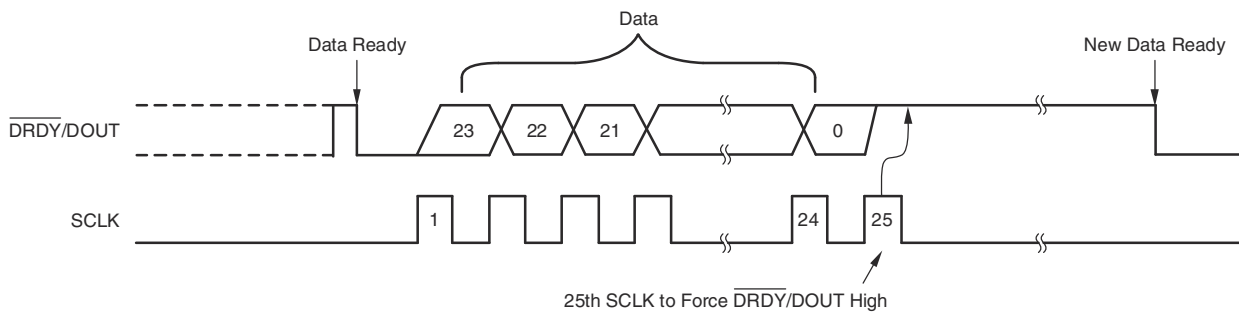
### 8.4.1 Offset Calibration Mode

Offset calibration can be initiated at any time to remove the ADS123x offset error. To initiate offset calibration, apply at least two additional SCLKs after retrieving 24 bits of data. 图 8-11 shows the timing pattern. The 25th SCLK sends  $\overline{DRDY}/DOUT$  high. The falling edge of the 26th SCLK begins the calibration cycle. Additional SCLK pulses can be sent after the 26th SCLK; however, minimize activity on SCLK during offset calibration for best results. The analog input pins are disconnected within the ADC and the appropriate signal is applied internally to perform the calibration.

When the calibration is completed,  $\overline{DRDY}/DOUT$  goes low, indicating that new data are ready. The first conversion after a calibration is fully settled and valid for use. The offset calibration takes exactly the same time as specified in ( $t_8$ ) right after the falling edge of the 26th SCLK.



图 8-11. Offset-Calibration Timing

表 8-9. Timing Requirements for 图 8-11

| PARAMETER |                                    | MIN                | MAX    | UNIT   |
|-----------|------------------------------------|--------------------|--------|--------|
| $t_8$ (1) | First data ready after calibration | SPEED = 1 (80 SPS) | 101.28 | 101.29 |
|           |                                    | SPEED = 0 (10 SPS) | 801.02 | 801.03 |

(1) Values given for  $f_{CLK} = 4.9152$  MHz. For different  $f_{CLK}$  frequencies, scale proportional to the CLK period. Expect a  $\pm 3\%$  variation when the internal oscillator is used.

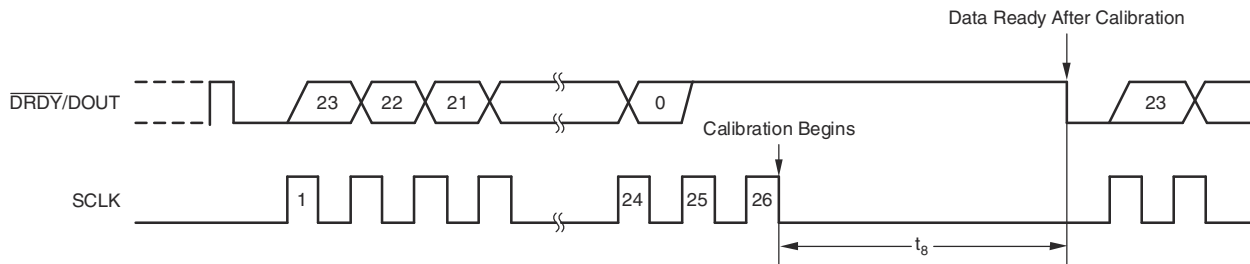
### 8.4.2 Standby Mode

Standby mode dramatically reduces power consumption by shutting down most of the circuitry. In standby mode, the entire analog circuitry is powered down and only the clock source circuitry is awake to reduce the wake-up time from the standby mode. To enter standby mode, simply hold SCLK high after  $\overline{DRDY}/DOUT$  goes low; see 图 8-12. Standby mode can be initiated at any time during readback; all 24 bits of data are not required to be retrieved beforehand.

When  $t_{10}$  has passed with SCLK held high, standby mode activates.  $\overline{DRDY}/DOUT$  stays high when standby mode begins. SCLK must remain high to stay in standby mode. To exit standby mode (wakeup), set SCLK low. The first data after exiting standby mode is valid.



图 8-12. Standby Mode Timing (Can be Used for Single Conversions)

表 8-10. Timing Requirements for 图 8-12

| PARAMETER    |  | MIN       | MAX   | UNIT  |
|--------------|--|-----------|-------|-------|
| $t_9$ (1)    | SCLK high after $\overline{\text{DRDY}}/\text{DOUT}$ goes low to activate standby mode | SPEED = 1 | 0     | 12.44 |
|              |  | SPEED = 0 | 0     | 99.94 |
| $t_{10}$ (1) | Standby mode activation time   | SPEED = 1 | 12.46 | ms    |
|              |  | SPEED = 0 | 99.96 |       |
| $t_{11}$ (1) | Data ready after exiting standby mode  | SPEED = 1 | 52.51 | 52.51 |
|              |  | SPEED = 0 | 401.8 | 401.8 |

(1) Values given for  $f_{\text{CLK}} = 4.9152$  MHz. For different  $f_{\text{CLK}}$  frequencies, scale proportional to the CLK period. Expect a  $\pm 3\%$  variation when an internal oscillator is used.

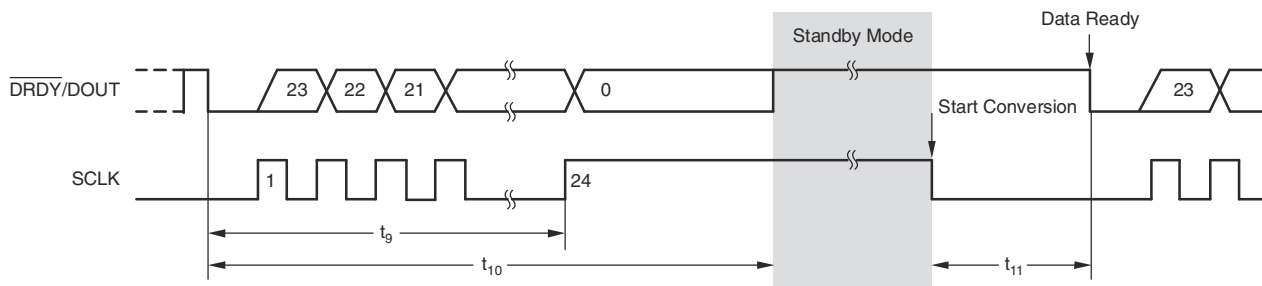
### 8.4.3 Standby Mode With Offset-Calibration

Offset-calibration can be set to run immediately after exiting standby mode. This feature is useful when the ADS123x is put in standby mode for long periods of time, and offset-calibration is desired afterwards to compensate for temperature or supply voltage changes.

To force an offset-calibration with standby mode, shift 25 SCLKs and take the SCLK pin high to enter standby mode. Offset-calibration then begins after wake-up; 图 8-13 shows the appropriate timing. Note the extra time needed after wake-up for calibration before data are ready. The first data after standby mode with offset-calibration is fully settled and can be used right away.



图 8-13. Standby Mode With Offset-Calibration Timing (Can be Used for Single Conversions)

表 8-11. Timing Requirements for 图 8-13

| PARAMETER    |   | MIN       | MAX | UNIT |
|--------------|---|-----------|-----|------|
| $t_{12}$ (1) | Data ready after exiting standby mode and calibration | SPEED = 1 | 103 | 103  |
|              |   | SPEED = 0 | 803 | 803  |

(1) Values given for  $f_{\text{CLK}} = 4.9152$  MHz. For different  $f_{\text{CLK}}$  frequencies, scale proportional to CLK period. Expect a  $\pm 3\%$  variation when an internal oscillator is used.

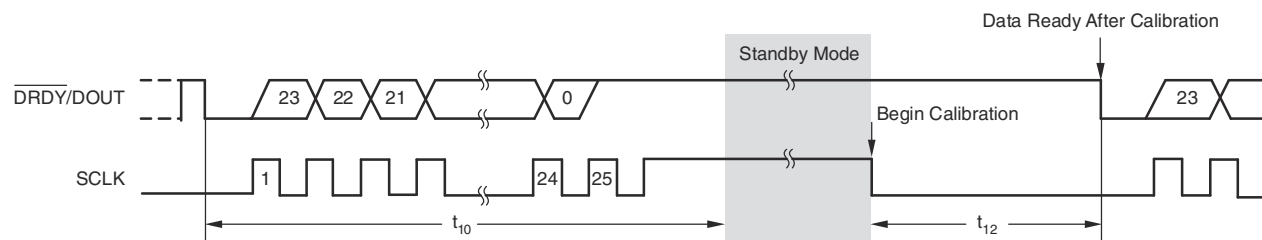
### 8.4.4 Power-Down Mode

Power-down mode shuts down the entire ADC circuitry and reduces the total power consumption close to zero. To enter power-down mode, hold the  $\overline{\text{PDOWN}}$  pin low. Power-down mode also resets the entire circuitry to free the ADC circuitry from locking up to an unknown state. Power-down mode can be initiated at any time during readback; not all 24 bits of data must be retrieved beforehand. 图 8-14 shows the wake-up timing from power-down mode.



图 8-14. Wake-Up Timing From Power-Down Mode

表 8-12. Timing Requirements for 图 8-14

| PARAMETER                      |                                    | MIN                               | TYP  | UNIT |
|--------------------------------|------------------------------------|-----------------------------------|------|------|
| t <sub>13</sub>                | Wake-up time after power-down mode | Internal clock                    | 7.95 | μs   |
|                                |                                    | External clock                    | 0.16 | μs   |
|                                |                                    | Crystal oscillator <sup>(1)</sup> | 5.6  | ms   |
| t <sub>14</sub> <sup>(2)</sup> | PDWN pulse duration                | 26                                |      | μs   |

(1) No capacitors on CLKIN/XTAL1 or XTAL2 outputs.

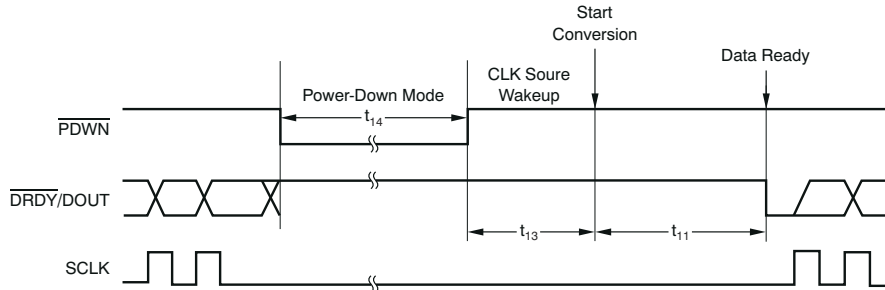
(2) Value given for  $f_{\text{CLK}} = 4.9152$  MHz. For different  $f_{\text{CLK}}$  frequencies, the scale is proportional to the CLK period except for a  $\pm 3\%$  variation when an internal oscillator is used.

### 8.4.5 Power-Up Sequence

When powering up the ADS123x, follow the prescribed  $\overline{\text{PDOWN}}$  pin sequence as shown in 图 8-15. At power-up, hold the  $\overline{\text{PDOWN}}$  pin low until after AVDD and DVDD have stabilized above the minimum specified voltage levels. After an initial delay where  $\overline{\text{PDOWN}}$  must be held low ( $t_{15}$ ), take  $\overline{\text{PDOWN}}$  high then toggle  $\overline{\text{PDOWN}}$  low to high with pulse durations ( $t_{16}$  and  $t_{17}$ ) as shown in 图 8-15 and 表 8-13. The ADC then begins operation as shown in 图 8-14 and 表 8-12. Control  $\overline{\text{PDOWN}}$  by the host processor to provide the required power-on timing.



图 8-15. Power-Up Timing Sequence

表 8-13. Power-up Timing Requirements for 图 8-15

| PARAMETER       |  | MIN <sup>(1)</sup> | UNIT |
|-----------------|--|--------------------|------|
| t <sub>15</sub> | Delay time, $\overline{\text{PDOWN}}$ high after AVDD, DVDD stable | 10                 | μs   |
| t <sub>16</sub> | Pulse duration, $\overline{\text{PDOWN}}$ high                     | 26                 | μs   |
| t <sub>17</sub> | Pulse duration, $\overline{\text{PDOWN}}$ low                      | 26                 | μs   |

(1)  $f_{\text{CLK}} = 4.9152$  MHz. For  $f_{\text{CLK}} < 4.9152$  MHz, adjust the  $\overline{\text{PDOWN}}$  delay time and pulse duration accordingly.

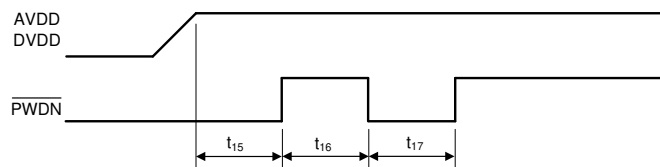
### 8.4.6 Summary of Serial Interface Waveforms

图 8-16 summarizes the serial interface waveforms.

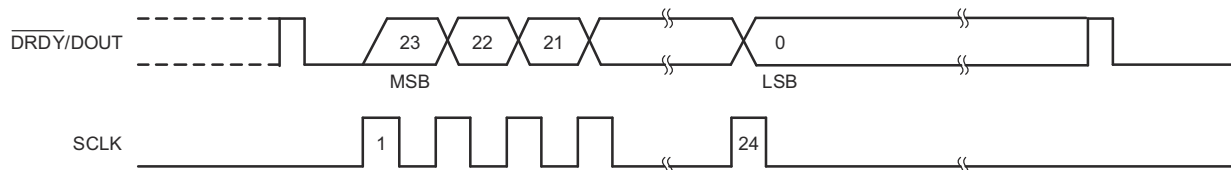

(a) Data Retrieval

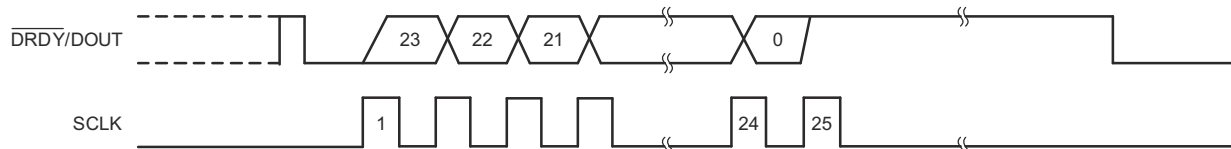

(b) Data Retrieval with  $\overline{\text{DRDY}}/\text{DOUT}$  Forced High Afterwards

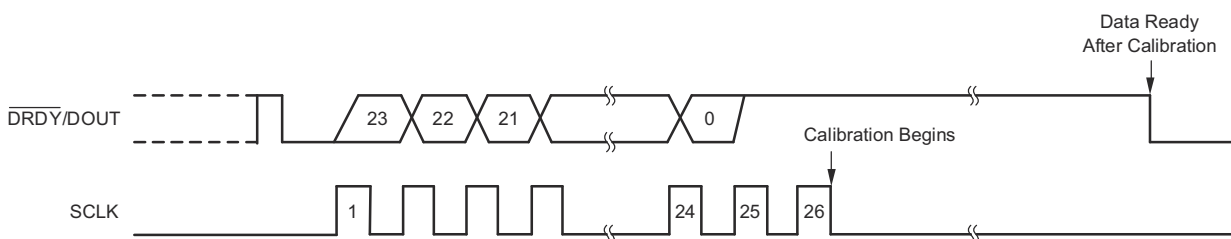

(c) Offset-Calibration Timing

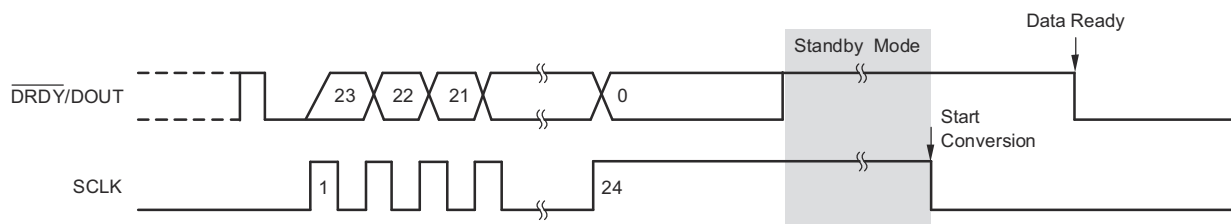

(d) Standby Mode/Single Conversions

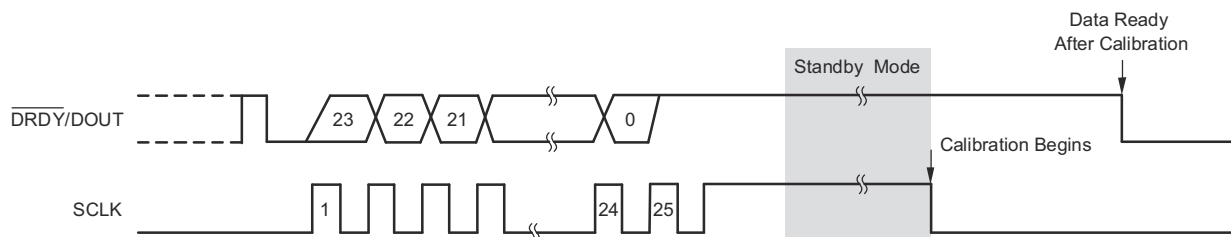

(e) Standby Mode/Single Conversions with Offset Calibration

图 8-16. Summary of Serial Interface Waveforms

## 9 Application and Implementation

### Note

Information in the following applications sections is not part of the TI component specification, and TI does not warrant its accuracy or completeness. TI's customers are responsible for determining suitability of components for their purposes, as well as validating and testing their design implementation to confirm system functionality.

### 9.1 Application Information

The ADS123x devices are high-resolution, 24-bit ADCs with an integrated low-noise PGA. Best performance is achieved by following the guidelines and recommendations described in the [Typical Application](#) section.

### 9.2 Typical Application

图 9-1 shows a circuit diagram of the ADS1232 as part of a weigh scale system. In this setup, the ADS1232 is configured to channel 1 input, gain = 128, and 10 SPS data rate. Gain = 128 is selected by tying the GAIN[1:0] pins to logic high (3 V in this example). Input channel 1 and data rate = 10 SPS are selected by tying input channel select pins A0 and TEMP to ground, and by tying the data rate select pin SPEED to ground. The unused channel 2 inputs are tied to ground.

The internal oscillator is selected by grounding the CLKIN/XTAL1 pin. The other clock options are 1) 4.9152-MHz crystal across the CLKIN/XTAL1 and XTAL2 pins, or 2) apply a clock to the CLKIN/XTAL1 pin (pin XTAL2 unconnected). The PWDN pin of the ADC is routed to the controller because this pin must be toggled after the ADC is powered. The bridge excitation voltage is connected to the ADC reference input pins (REFP, REFN). Not shown in 图 9-1 are R-C input filters for the signal and reference inputs. If these filters are used, match the filter time constants to maintain cancellation of noise common to both signal and reference inputs.



图 9-1. Weigh-Scale Application

## 9.2.1 Design Requirements

表 9-1 summarizes the design performance goals. 表 9-2 summarizes the system design parameters.

表 9-1. Design Goals

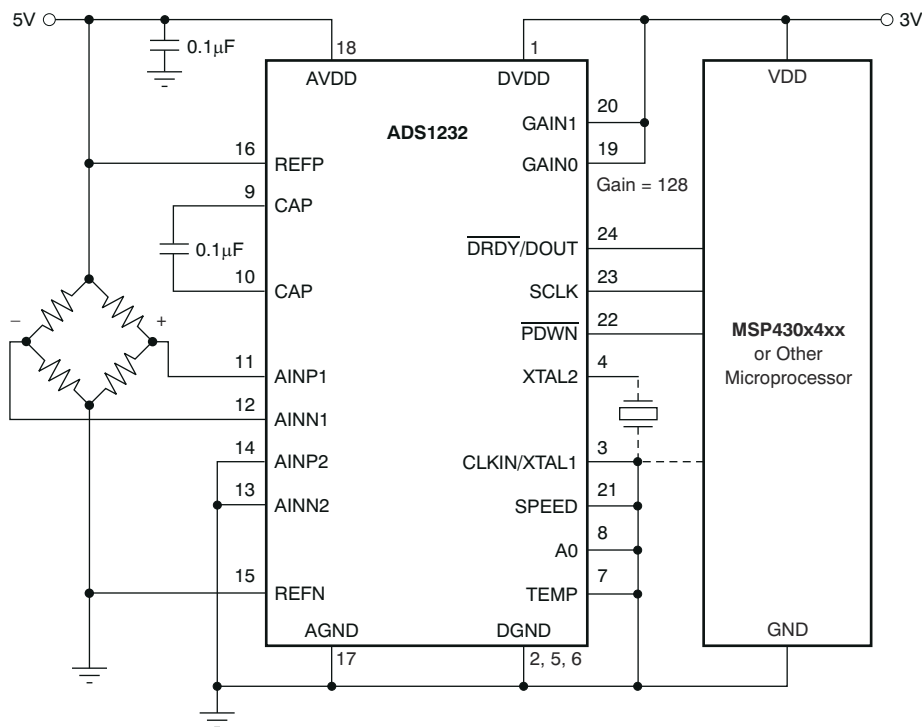
| DESIGN GOAL                     | VALUE   |
|---------------------------------|---|
| Noise-free resolution           | 80,000 counts / 130,000 counts (post averaging) |
| Sample rate                     | 10 SPS  |
| Input step settling time        | 500 ms / 900 ms (post averaging)                |
| 50-Hz and 60-Hz noise rejection | >100 dB   |

表 9-2. Design Parameters

| DESIGN PARAMETERS                            | DESIGN VALUE |
|--|--------------|
| Bridge resistance                            | 1 k $\Omega$ |
| Bridge excitation voltage                    | 5 V          |
| Load cell sensitivity                        | 2 mV/V       |
| Bridge full-scale output                     | 10 mV        |
| ADC analog power supply                      | 5 V          |
| Host controller and ADC digital power supply | 3 V          |

## 9.2.2 Detailed Design Procedure

Common performance metrics of a weigh scale are noise-free resolution (or counts) and offset and gain stability (drift) after calibrating the weigh scale. 表 7-1 to 表 7-4 illustrate ADC noise performance expressed as an input-referred quantity over gain, data rate, and analog supply voltage.

In this design example, the ADC analog supply voltage (5 V) is used as the bridge excitation voltage. 5-V excitation optimizes the bridge signal output compared to 3-V excitation and also has the benefit of optimizing the ADC conversion noise. Gain = 128 is selected because it also provides optimal noise performance. The front end circuitry of the ADC easily accommodates the 10-mV bridge output. In summary, the ADC configuration that yields the highest resolution while achieving the sample rate and settling time requirements is AVDD = 5 V, bridge excitation = 5 V, gain = 128, and sample rate = 10 SPS.

Signal-to-noise performance is improved by using a higher gauge-factor bridge (example 3 mV/V bridge), or by increasing the excitation voltage. If the excitation voltage > 5 V, a voltage divider is required to reduce the voltage at the ADC reference inputs.

Noise-free counts are improved by post averaging the data (for example, a moving-average filter performed in the microcontroller). A moving average filter reduces noise by a factor of  $\sqrt{N}$ , where N is the number of readings averaged. However, a moving average filter increases the input step settling time due to the latency caused by averaging.

The other key performance attributes are DC offset and gain drift, and 50-Hz and 60-Hz noise rejection. 图 6-14 and 图 6-16 illustrate the distributions of offset and gain drift performance. 50-Hz and 60-Hz noise rejection is described in 图 8-6. The ADC provides over 100-dB rejection with  $\pm 3\%$  variation of the ADC clock frequency.

## 9.2.3 Application Curves

To evaluate the ADC's noise performance, four fixed-value, 1-k $\Omega$  low-drift precision resistors are connected in a bridge arrangement to simulate a bridge sensor. The simulator provides the same thermal noise generated by a physical bridge. One of the four bridge resistors is modified to 1.008 k $\Omega$  in order to provide a 10-mV output signal. The 10-mV signal is typical of a 2-mV/V load cell using 5-V excitation.

图 9-2 shows the ADC performance with data taken over a 60-second period. The 60-second period reveals true ADC peak-to-peak noise performance. 图 9-3 shows the same conversion data processed by an external moving average filter (average x4). The noise-free resolution of the ADC is approximately 85,000 counts. Over the same 60-second period, the moving average filter improves noise-free resolution to 135,000 counts. The noise-free resolution (bits) corresponding to unfiltered and filtered data are 16.3 bits and 17.1 bits. See 方程式 2 to calculate noise-free resolution in bits. In order to evaluate the actual noise-free resolution of the system, the 10-mV signal is used in the calculation, rather than the full input range of the ADC ( $39\text{ mV} = V_{\text{REF}} / 128$ ),

As shown in the noise plots, the moving average filter reduces noise by approximately one-half. As a consequence of the post filter operation, the input step settling time increases from 500 ms to 900 ms (500 ms because of the ADC settling response time, 400 ms because of the post-averaging filter).

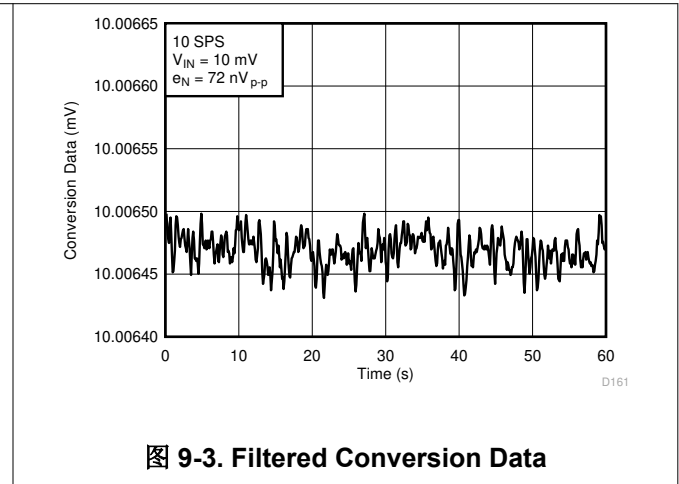
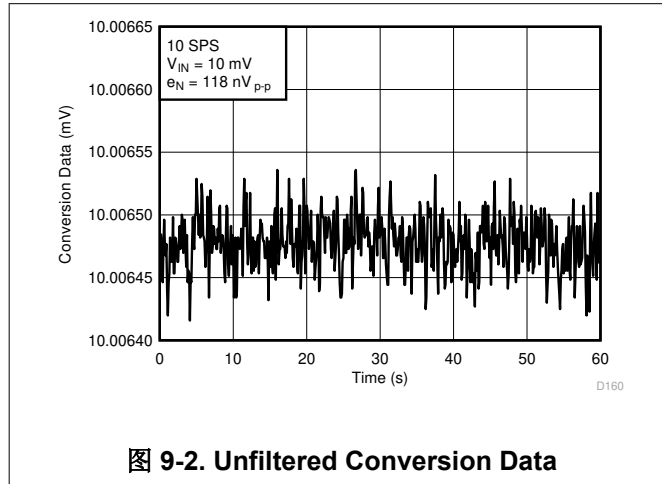

## 10 Power Supply Recommendations

At device power-on, follow the  $\overline{\text{PWDN}}$  pin toggle sequence as detailed in the [Power-Up Sequence](#) section.

The ADC has an analog power supply (AVDD) and digital power supply (DVDD). The supply range is 2.7 V to 5.25 V. The analog and digital supplies can be tied together, however the digital power supply must be clean and free of glitches and transients, which can be generated by the operation of LEDs, relays, and so forth. The bridge excitation voltage is often the same as the ADC supply voltage, so it is important the supply voltage is free of transients.

Voltage ripple produced by switching power supplies can also degrade ADC performance. The use a low-dropout regulator (LDOs) can reduce voltage ripple caused by switching power supplies.

### 10.1 Power-Supply Decoupling

Good power-supply decoupling is important in order to achieve rated performance. The power supplies must be decoupled close to the power-supply pins using short, direct connections to ground. For both analog and digital power supplies, connect a 0.1- $\mu\text{F}$  capacitor (X7R-dielectric ceramic) from the power-supply pins to the ground plane.



## 11 Layout

Good layout practices are crucial to realize the full-performance of the ADC. Poor grounding can quickly degrade the noise performance. The following layout guidelines help provide the best results.

### 11.1 Layout Guidelines

For best performance, dedicate a PCB layer to a ground plane and do not route any other signal traces on this layer. However, depending on space limitations, a dedicated ground plane may not be practical. If a continuous ground plane is not possible, connect the individual plane segments in one place at the ADC.

Route digital traces away from the PGA output pins (CAP) and away from all analog inputs and associated components in order to minimize interference. Maintain differential trace routing for the input signal and reference signal to minimize RFI susceptibility.

Use C0G capacitors for analog and reference input filters and the PGA output capacitor in high-linearity applications. High-K type capacitors (such as Y5V and X7R) should be avoided. Place supply bypass and the PGA bypass capacitors as close as possible to the device pins using short, direct traces. For optimum performance, use low-impedance connections (such as multiple vias) on the ground-side connections of the bypass capacitors.

Avoid long traces on  $\overline{\text{DRDY}}/\text{DOUT}$ , because high trace capacitance can lead to increased ADC noise. Use a series resistor or a local buffer if long traces are used. When applying an external clock, be sure the clock is free of overshoot and glitches. A source-termination resistor placed at the clock buffer helps control reflections and overshoot. Glitches present on the clock signal can lead to increased noise and possible mis-operation and must be avoided.

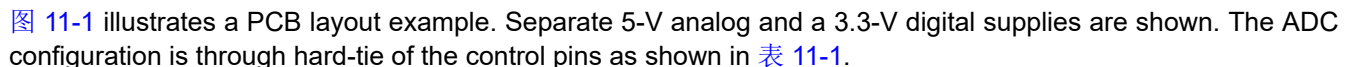
 **图 11-1** illustrates a PCB layout example. Separate 5-V analog and a 3.3-V digital supplies are shown. The ADC configuration is through hard-tie of the control pins as shown in **表 11-1**.

**表 11-1. Layout Example Pin Connections**

| MODE               | PIN CONTROL | VOLTAGE |
|--------------------|-------------|---------|
| Data rate = 10 SPS | SPEED       | 0 V     |
| Gain = 128         | GAIN[1:0]   | 3.3 V   |
| Input = channel 1  | A0, TEMP    | 0 V     |

## 11.2 Layout Example



图 11-1. ADS1232 Layout Example

## 12 Device and Documentation Support

### 12.1 接收文档更新通知

要接收文档更新通知，请导航至 [ti.com](http://ti.com) 上的器件产品文件夹。点击 [订阅更新](#) 进行注册，即可每周接收产品信息更改摘要。有关更改的详细信息，请查看任何已修订文档中包含的修订历史记录。

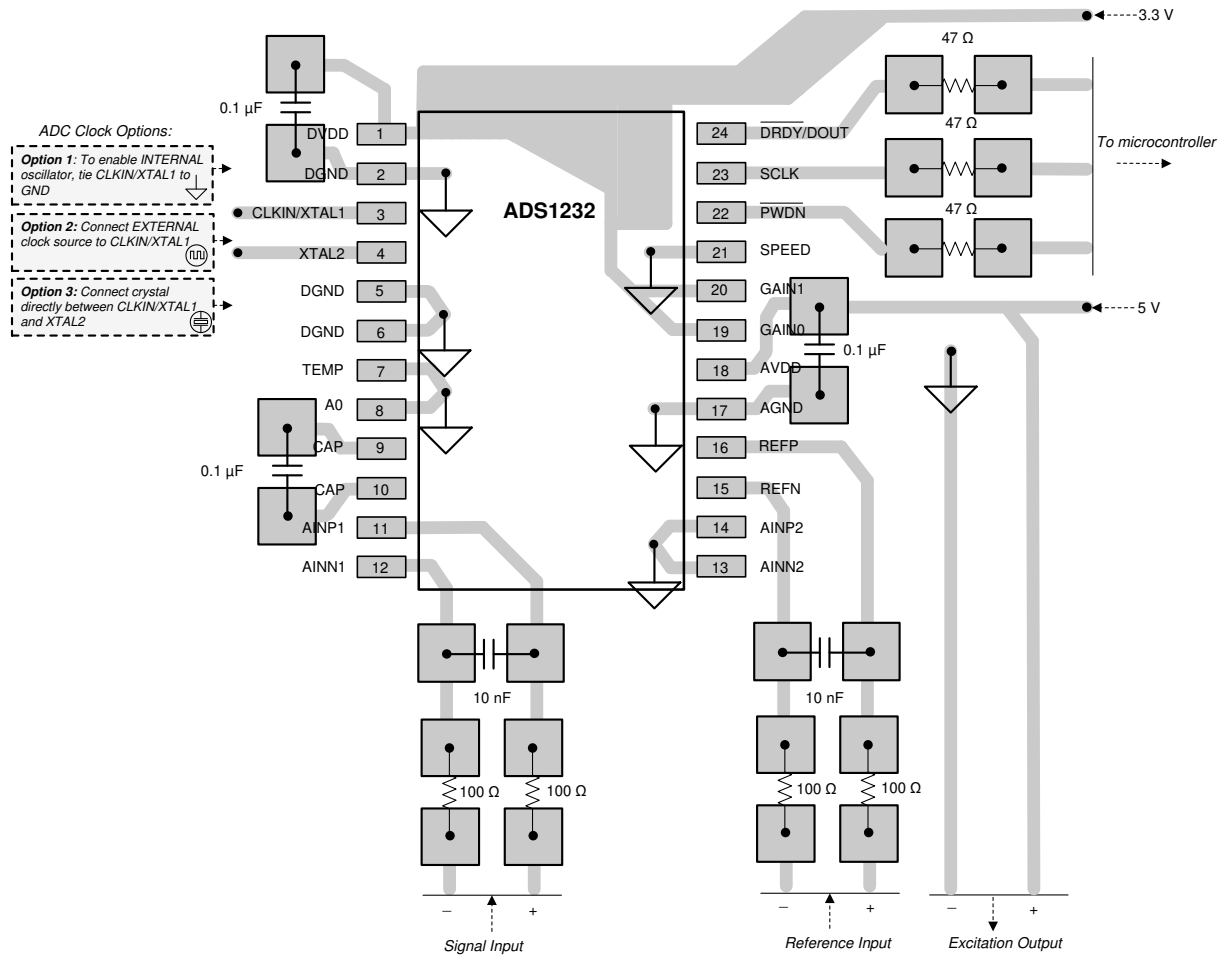
### 12.2 支持资源

**TI E2E™ 支持论坛** 是工程师的重要参考资料，可直接从专家获得快速、经过验证的解答和设计帮助。搜索现有解答或提出自己的问题可获得所需的快速设计帮助。

链接的内容由各个贡献者“按原样”提供。这些内容并不构成 TI 技术规范，并且不一定反映 TI 的观点；请参阅 TI 的《[使用条款](#)》。

### 12.3 Trademarks

TI E2E™ is a trademark of Texas Instruments.  
所有商标均为其各自所有者的财产。

### 12.4 静电放电警告



静电放电 (ESD) 会损坏这个集成电路。德州仪器 (TI) 建议通过适当的预防措施处理所有集成电路。如果不遵守正确的处理和安装程序，可能会损坏集成电路。

ESD 的损坏小至导致微小的性能降级，大至整个器件故障。精密的集成电路可能更容易受到损坏，这是因为非常细微的参数更改都可能会导致器件与其发布的规格不相符。

### 12.5 术语表

**TI 术语表**      本术语表列出并解释了术语、首字母缩略词和定义。

## 13 Mechanical, Packaging, and Orderable Information

The following pages include mechanical, packaging, and orderable information. This information is the most current data available for the designated devices. This data is subject to change without notice and revision of this document. For browser-based versions of this data sheet, refer to the left-hand navigation.

**PACKAGING INFORMATION**

| Orderable Device | Status<br>(1) | Package Type | Package Drawing | Pins | Package Qty | Eco Plan<br>(2) | Lead finish/<br>Ball material<br>(6) | MSL Peak Temp<br>(3) | Op Temp (°C) | Device Marking<br>(4/5) | Samples                 |
|------------------|---------------|--------------|-----------------|------|-------------|-----------------|--------------------------------------|----------------------|--------------|-------------------------|-------------------------|
| ADS1232IPW       | ACTIVE        | TSSOP        | PW              | 24   | 60          | RoHS & Green    | NIPDAU                               | Level-2-260C-1 YEAR  | -40 to 105   | ADS1232                 | <a href="#">Samples</a> |
| ADS1232IPWG4     | ACTIVE        | TSSOP        | PW              | 24   | 60          | RoHS & Green    | NIPDAU                               | Level-2-260C-1 YEAR  | -40 to 105   | ADS1232                 | <a href="#">Samples</a> |
| ADS1232IPWR      | ACTIVE        | TSSOP        | PW              | 24   | 2000        | RoHS & Green    | NIPDAU                               | Level-2-260C-1 YEAR  | -40 to 105   | ADS1232                 | <a href="#">Samples</a> |
| ADS1232IPWRG4    | ACTIVE        | TSSOP        | PW              | 24   | 2000        | RoHS & Green    | NIPDAU                               | Level-2-260C-1 YEAR  | -40 to 105   | ADS1232                 | <a href="#">Samples</a> |
| ADS1234IPW       | ACTIVE        | TSSOP        | PW              | 28   | 50          | RoHS & Green    | NIPDAU                               | Level-2-260C-1 YEAR  | -40 to 105   | ADS1234                 | <a href="#">Samples</a> |
| ADS1234IPWG4     | ACTIVE        | TSSOP        | PW              | 28   | 50          | RoHS & Green    | NIPDAU                               | Level-2-260C-1 YEAR  | -40 to 105   | ADS1234                 | <a href="#">Samples</a> |
| ADS1234IPWR      | ACTIVE        | TSSOP        | PW              | 28   | 2000        | RoHS & Green    | NIPDAU                               | Level-2-260C-1 YEAR  | -40 to 105   | ADS1234                 | <a href="#">Samples</a> |

(1) The marketing status values are defined as follows:

**ACTIVE:** Product device recommended for new designs.

**LIFEBUY:** TI has announced that the device will be discontinued, and a lifetime-buy period is in effect.

**NRND:** Not recommended for new designs. Device is in production to support existing customers, but TI does not recommend using this part in a new design.

**PREVIEW:** Device has been announced but is not in production. Samples may or may not be available.

**OBSOLETE:** TI has discontinued the production of the device.

(2) **RoHS:** TI defines "RoHS" to mean semiconductor products that are compliant with the current EU RoHS requirements for all 10 RoHS substances, including the requirement that RoHS substance do not exceed 0.1% by weight in homogeneous materials. Where designed to be soldered at high temperatures, "RoHS" products are suitable for use in specified lead-free processes. TI may reference these types of products as "Pb-Free".

**RoHS Exempt:** TI defines "RoHS Exempt" to mean products that contain lead but are compliant with EU RoHS pursuant to a specific EU RoHS exemption.

**Green:** TI defines "Green" to mean the content of Chlorine (Cl) and Bromine (Br) based flame retardants meet JS709B low halogen requirements of <=1000ppm threshold. Antimony trioxide based flame retardants must also meet the <=1000ppm threshold requirement.

(3) MSL, Peak Temp. - The Moisture Sensitivity Level rating according to the JEDEC industry standard classifications, and peak solder temperature.

(4) There may be additional marking, which relates to the logo, the lot trace code information, or the environmental category on the device.

(5) Multiple Device Markings will be inside parentheses. Only one Device Marking contained in parentheses and separated by a "~" will appear on a device. If a line is indented then it is a continuation of the previous line and the two combined represent the entire Device Marking for that device.

<sup>(6)</sup> Lead finish/Ball material - Orderable Devices may have multiple material finish options. Finish options are separated by a vertical ruled line. Lead finish/Ball material values may wrap to two lines if the finish value exceeds the maximum column width.

**Important Information and Disclaimer:**The information provided on this page represents TI's knowledge and belief as of the date that it is provided. TI bases its knowledge and belief on information provided by third parties, and makes no representation or warranty as to the accuracy of such information. Efforts are underway to better integrate information from third parties. TI has taken and continues to take reasonable steps to provide representative and accurate information but may not have conducted destructive testing or chemical analysis on incoming materials and chemicals. TI and TI suppliers consider certain information to be proprietary, and thus CAS numbers and other limited information may not be available for release.

In no event shall TI's liability arising out of such information exceed the total purchase price of the TI part(s) at issue in this document sold by TI to Customer on an annual basis.

**TAPE AND REEL INFORMATION**

**QUADRANT ASSIGNMENTS FOR PIN 1 ORIENTATION IN TAPE**



\*All dimensions are nominal

| Device      | Package Type | Package Drawing | Pins | SPQ  | Reel Diameter (mm) | Reel Width W1 (mm) | A0 (mm) | B0 (mm) | K0 (mm) | P1 (mm) | W (mm) | Pin1 Quadrant |
|-------------|--------------|-----------------|------|------|--------------------|--------------------|---------|---------|---------|---------|--------|---------------|
| ADS1232IPWR | TSSOP        | PW              | 24   | 2000 | 330.0              | 16.4               | 6.95    | 8.3     | 1.6     | 8.0     | 16.0   | Q1            |
| ADS1234IPWR | TSSOP        | PW              | 28   | 2000 | 330.0              | 16.4               | 6.9     | 10.2    | 1.8     | 12.0    | 16.0   | Q1            |

**TAPE AND REEL BOX DIMENSIONS**

\*All dimensions are nominal

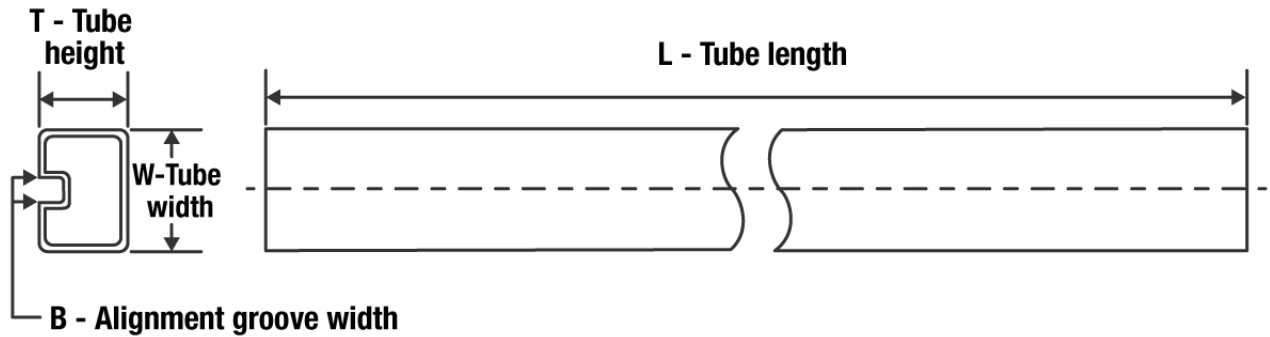
| Device      | Package Type | Package Drawing | Pins | SPQ  | Length (mm) | Width (mm) | Height (mm) |
|-------------|--------------|-----------------|------|------|-------------|------------|-------------|
| ADS1232IPWR | TSSOP        | PW              | 24   | 2000 | 350.0       | 350.0      | 43.0        |
| ADS1234IPWR | TSSOP        | PW              | 28   | 2000 | 350.0       | 350.0      | 43.0        |

**TUBE**

\*All dimensions are nominal

| Device       | Package Name | Package Type | Pins | SPQ | L (mm) | W (mm) | T (μm) | B (mm) |
|--------------|--------------|--------------|------|-----|--------|--------|--------|--------|
| ADS1232IPW   | PW           | TSSOP        | 24   | 60  | 530    | 10.2   | 3600   | 3.5    |
| ADS1232IPWG4 | PW           | TSSOP        | 24   | 60  | 530    | 10.2   | 3600   | 3.5    |
| ADS1234IPW   | PW           | TSSOP        | 28   | 50  | 530    | 10.2   | 3600   | 3.5    |
| ADS1234IPWG4 | PW           | TSSOP        | 28   | 50  | 530    | 10.2   | 3600   | 3.5    |



PW0024A

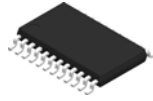

# PACKAGE OUTLINE

## TSSOP - 1.2 mm max height

SMALL OUTLINE PACKAGE

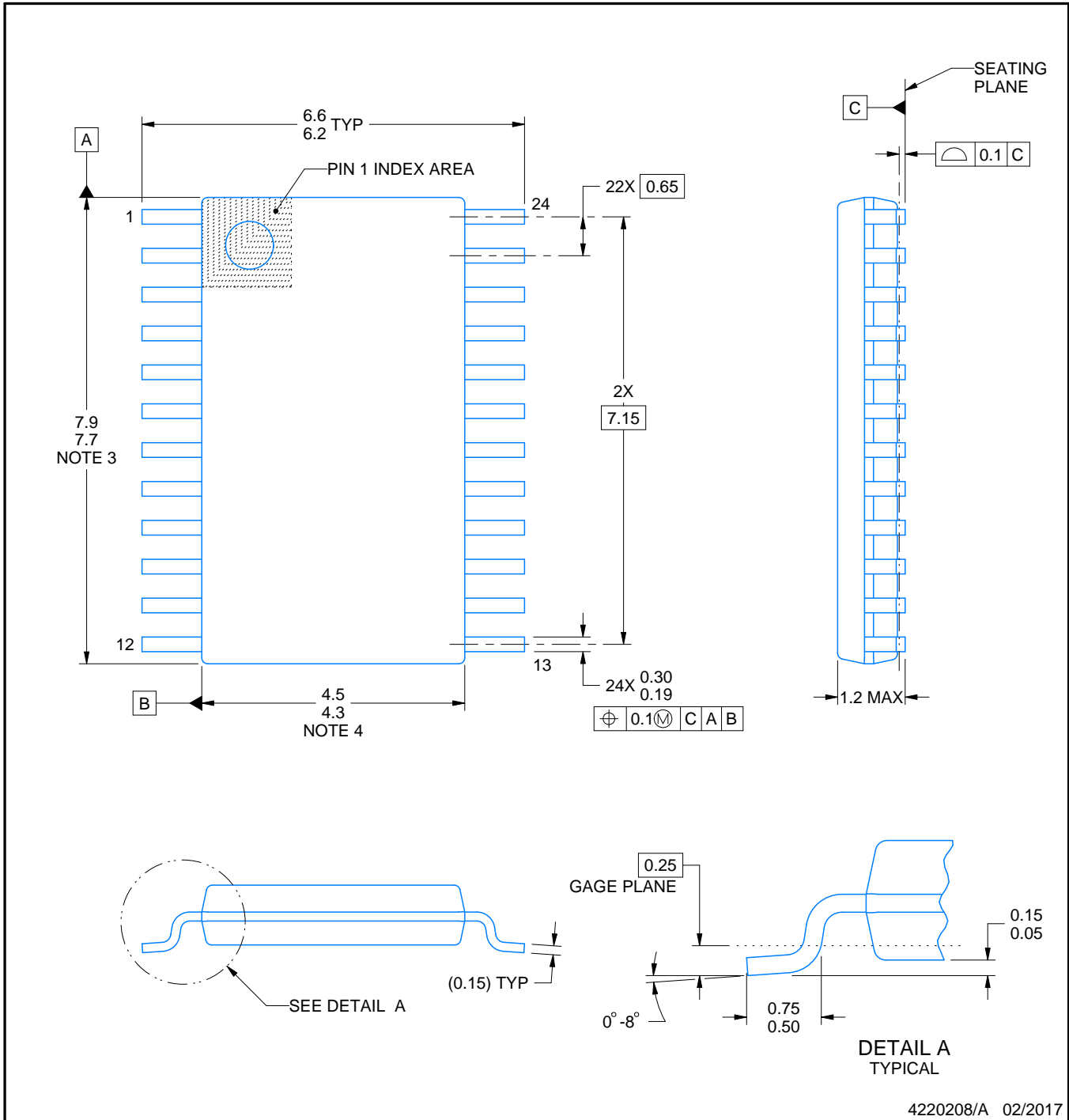

NOTES:

1. All linear dimensions are in millimeters. Any dimensions in parenthesis are for reference only. Dimensioning and tolerancing per ASME Y14.5M.
2. This drawing is subject to change without notice.
3. This dimension does not include mold flash, protrusions, or gate burrs. Mold flash, protrusions, or gate burrs shall not exceed 0.15 mm per side.
4. This dimension does not include interlead flash. Interlead flash shall not exceed 0.25 mm per side.
5. Reference JEDEC registration MO-153.

# EXAMPLE BOARD LAYOUT

PW0024A

TSSOP - 1.2 mm max height

SMALL OUTLINE PACKAGE

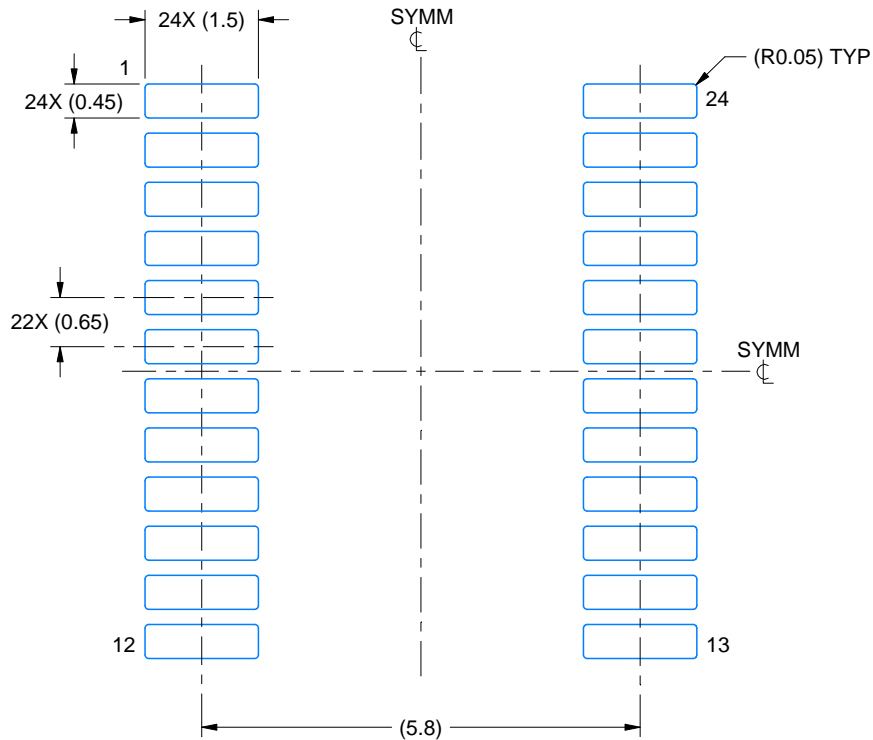

LAND PATTERN EXAMPLE  
EXPOSED METAL SHOWN  
SCALE: 10X

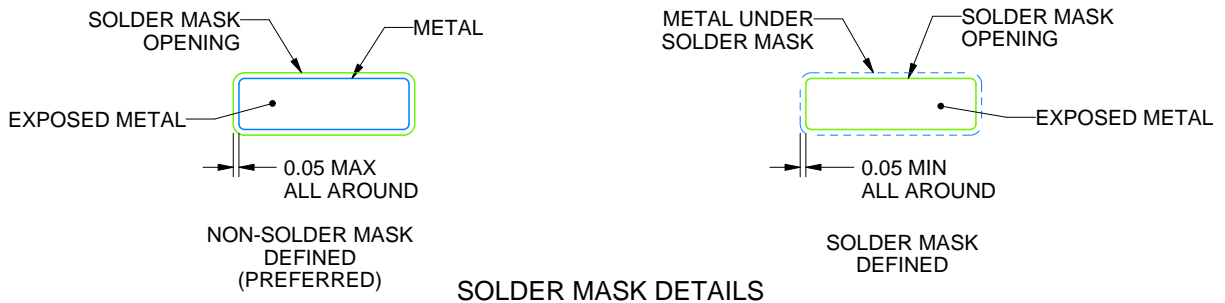

SOLDER MASK DETAILS

4220208/A 02/2017

NOTES: (continued)

- 6. Publication IPC-7351 may have alternate designs.
- 7. Solder mask tolerances between and around signal pads can vary based on board fabrication site.

# EXAMPLE STENCIL DESIGN

PW0024A

TSSOP - 1.2 mm max height

SMALL OUTLINE PACKAGE



NOTES: (continued)

8. Laser cutting apertures with trapezoidal walls and rounded corners may offer better paste release. IPC-7525 may have alternate design recommendations.
9. Board assembly site may have different recommendations for stencil design.

# MECHANICAL DATA

PW (R-PDSO-G28)

PLASTIC SMALL OUTLINE

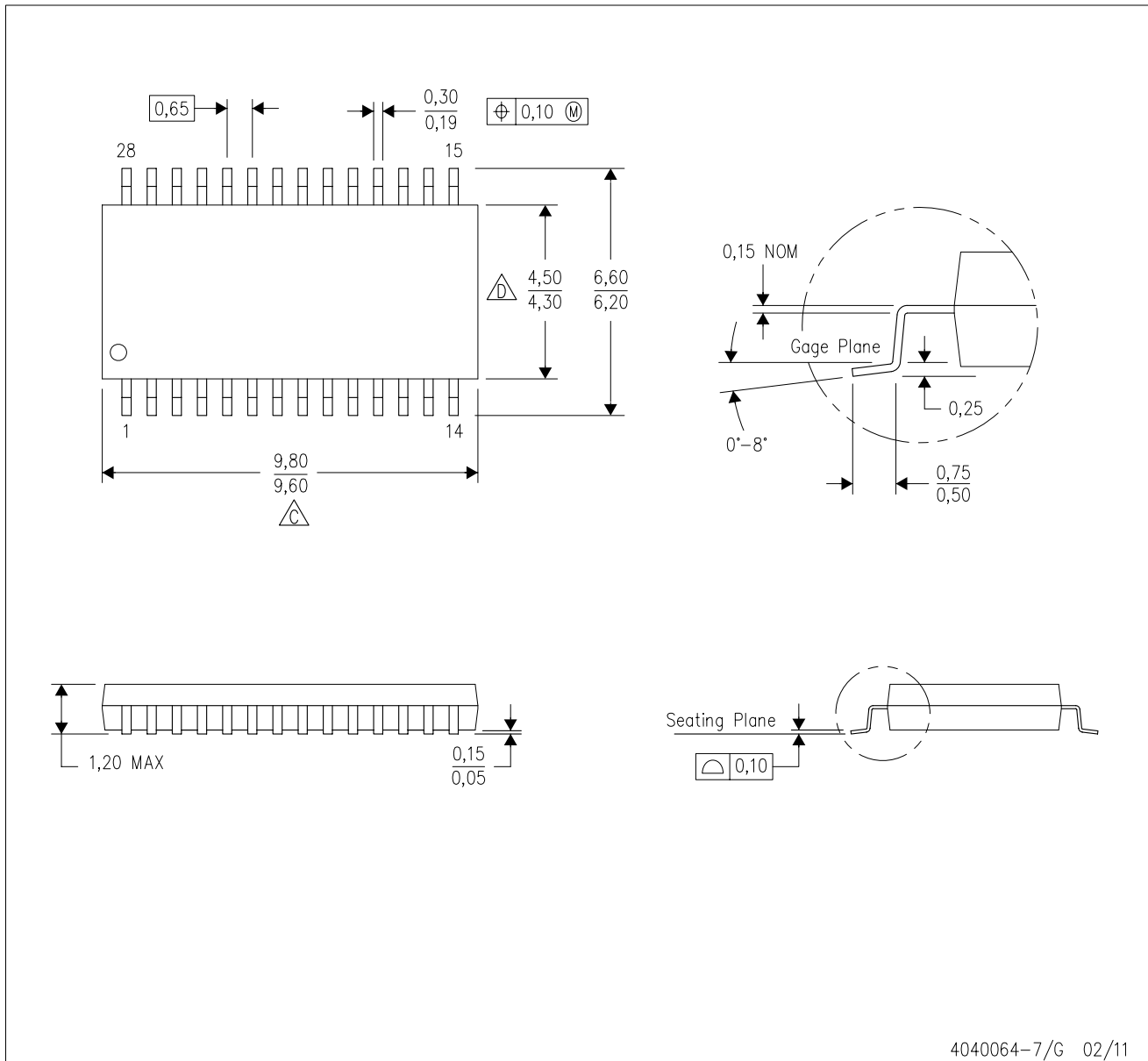

4040064-7/G 02/11

- NOTES:
- A. All linear dimensions are in millimeters. Dimensioning and tolerancing per ASME Y14.5M-1994.
  - B. This drawing is subject to change without notice.
  - C. Body length does not include mold flash, protrusions, or gate burrs. Mold flash, protrusions, or gate burrs shall not exceed 0,15 each side.
  - D. Body width does not include interlead flash. Interlead flash shall not exceed 0,25 each side.
  - E. Falls within JEDEC MO-153

PW (R-PDSO-G28)

PLASTIC SMALL OUTLINE

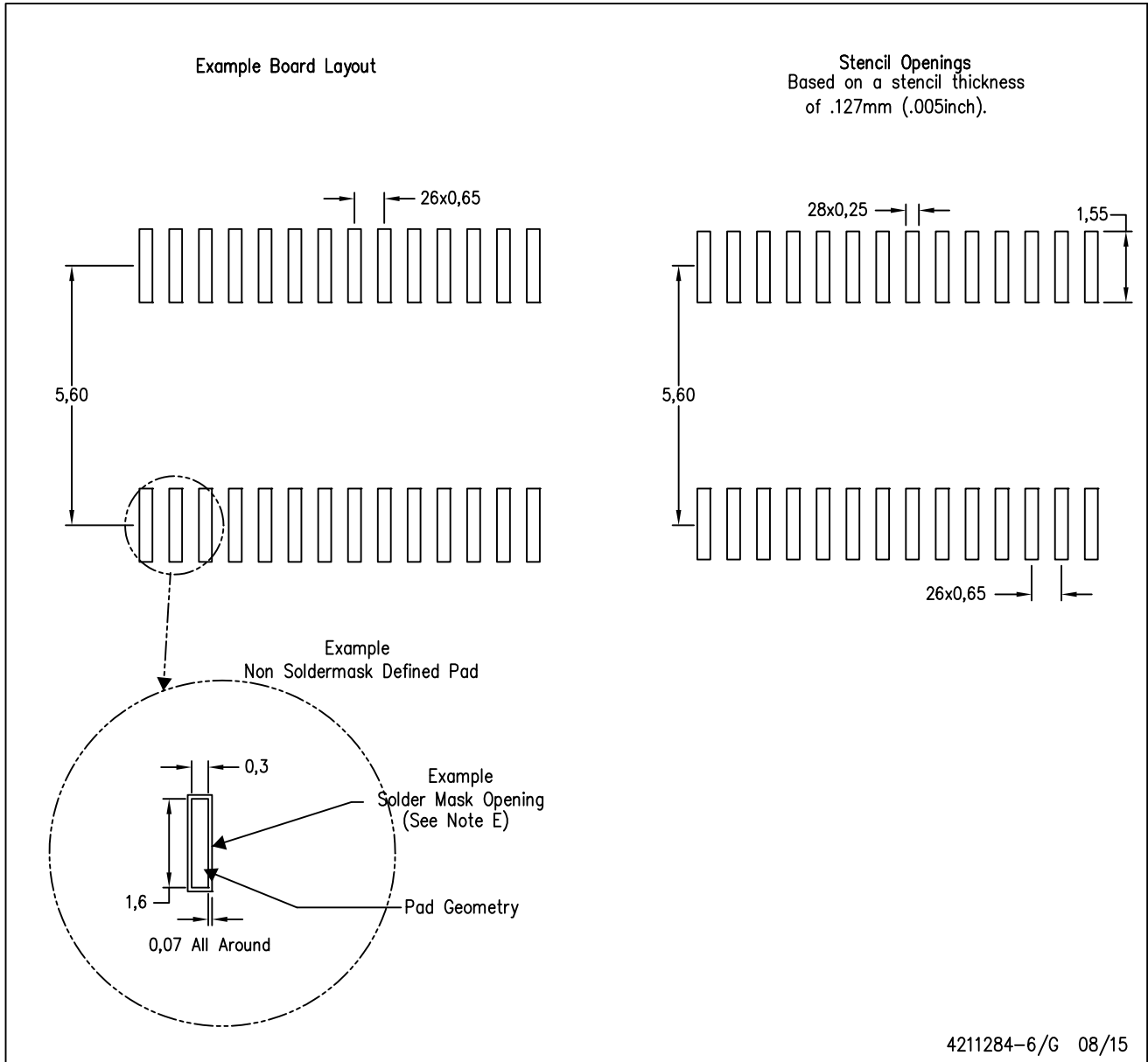

- NOTES:
- A. All linear dimensions are in millimeters.
  - B. This drawing is subject to change without notice.
  - C. Publication IPC-7351 is recommended for alternate design.
  - D. Laser cutting apertures with trapezoidal walls and also rounding corners will offer better paste release. Customers should contact their board assembly site for stencil design recommendations. Refer to IPC-7525 for other stencil recommendations.
  - E. Customers should contact their board fabrication site for solder mask tolerances between and around signal pads.

## 重要声明和免责声明

TI“按原样”提供技术和可靠性数据（包括数据表）、设计资源（包括参考设计）、应用或其他设计建议、网络工具、安全信息和其他资源，不保证没有瑕疵且不做任何明示或暗示的担保，包括但不限于对适销性、某特定用途方面的适用性或不侵犯任何第三方知识产权的暗示担保。

这些资源可供使用 TI 产品进行设计的熟练开发人员使用。您将自行承担以下全部责任：(1) 针对您的应用选择合适的 TI 产品，(2) 设计、验证并测试您的应用，(3) 确保您的应用满足相应标准以及任何其他功能安全、信息安全、监管或其他要求。

这些资源如有变更，恕不另行通知。TI 授权您仅可将这些资源用于研发本资源所述的 TI 产品的应用。严禁对这些资源进行其他复制或展示。您无权使用任何其他 TI 知识产权或任何第三方知识产权。您应全额赔偿因在这些资源的使用中对 TI 及其代表造成的任何索赔、损害、成本、损失和债务，TI 对此概不负责。

TI 提供的产品受 [TI 的销售条款](#) 或 [ti.com](#) 上其他适用条款/TI 产品随附的其他适用条款的约束。TI 提供这些资源并不会扩展或以其他方式更改 TI 针对 TI 产品发布的适用的担保或担保免责声明。

TI 反对并拒绝您可能提出的任何其他或不同的条款。

邮寄地址：Texas Instruments, Post Office Box 655303, Dallas, Texas 75265

Copyright © 2022，德州仪器 (TI) 公司