

CD4017B, CD4022B Types

CMOS Counter/Dividers

High-Voltage Types (20-Volt Rating)

CD4017B—Decade Counter with
10 Decoded Outputs

CD4022B—Octal Counter with
8 Decoded Outputs

■ CD4017B and CD4022B are 5-stage and 4-stage Johnson counters having 10 and 8 decoded outputs, respectively. Inputs include a CLOCK, a RESET, and a CLOCK INHIBIT signal. Schmitt trigger action in the CLOCK input circuit provides pulse shaping that allows unlimited clock input pulse rise and fall times.

These counters are advanced one count at the positive clock signal transition if the CLOCK INHIBIT signal is low. Counter advancement via the clock line is inhibited when the CLOCK INHIBIT signal is high. A high RESET signal clears the counter to its zero count. Use of the Johnson counter configuration permits high-speed operation, 2-input decode-gating and spike-free decoded outputs. Anti-lock gating is provided, thus assuring proper counting sequence. The decoded outputs are normally low and go high only at their respective decoded time slot. Each decoded output remains high for one full clock cycle. A CARRY-OUT signal completes one cycle every 10 clock input cycles in the CD4017B or every 8 clock input cycles in the CD4022B and is used to ripple-clock the succeeding device in a multi-device counting chain.

Features:

- Fully static operation
- Medium-speed operation . . .
10 MHz (typ.) at $V_{DD} = 10\text{ V}$
- Standardized, symmetrical output characteristics
- 100% tested for quiescent current at 20 V
- 5-V, 10-V, and 15-V parametric ratings
- Meets all requirements of JEDEC Tentative Standard No. 13A, "Standard Specifications for Description of 'B' Series CMOS Devices"

Applications:

- Decade counter/decimal decode display (CD4017B)
- Binary counter/decoder
- Frequency division
- Counter control/timers
- Divide-by-N counting
- For further application information, see ICAN-6166 "COS/MOS MSI Counter and Register Design and Applications"

The CD4017B and CD4022B types are supplied in 16-lead hermetic dual-in-line ceramic packages (F3A suffix), 16-lead dual-in-line plastic package (E suffix), 16-lead small-outline packages (NSR suffix), and 16-lead thin shrink small-outline packages (PW and PWR suffixes). The CD4017B types also are supplied in 16-lead small-outline packages (M and M96 suffixes).

RECOMMENDED OPERATING CONDITIONS

For maximum reliability, nominal operating conditions should be selected so that operation is always within the following ranges:

CHARACTERISTICS	V_{DD} (V)	LIMITS		UNITS
		Min.	Max.	
Supply-Voltage Range (For T_A = Full Package-Temperature Range)		3	18	V
Clock Input Frequency, f_{CL}	5	—	2.5	MHz
	10	—	5	
	15	—	5.5	
Clock Pulse Width, t_W	5	200	—	ns
	10	90	—	
	15	60	—	
Clock Rise & Fall Time, t_{rCL} , t_{fCL}	5	UNLIMITED*		
	10			
	15			
Clock Inhibit Setup Time, t_s	5	230	—	ns
	10	100	—	
	15	70	—	
Reset Pulse Width, t_{RW}	5	260	—	ns
	10	110	—	
	15	60	—	
Reset Removal Time, t_{rem}	5	400	—	ns
	10	280	—	
	15	150	—	

*Only if Pin 14 is used as the clock input. If Pin 13 is used as the clock input and Pin 14 is tied high (for advancing count on negative transition of the clock), rise and fall time should be $\leq 15\ \mu\text{s}$.

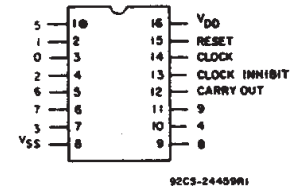
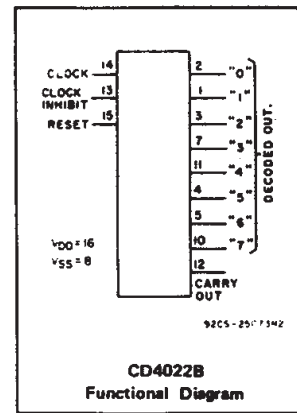
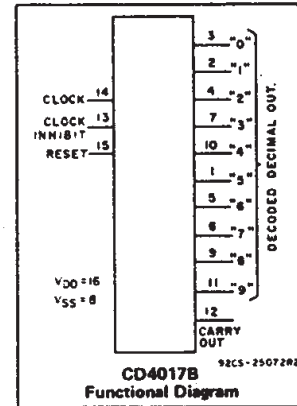

TOP VIEW
CD4017B
TERMINAL DIAGRAM

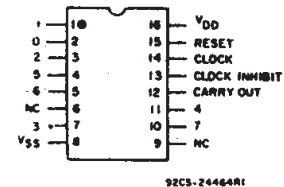

TOP VIEW
NC - no connection
CD4022B
TERMINAL DIAGRAM

3
COMMERCIAL CMOS
HIGH VOLTAGE ICs

CD4017B, CD4022B Types



Fig. 2 - Timing diagram for CD4017B.

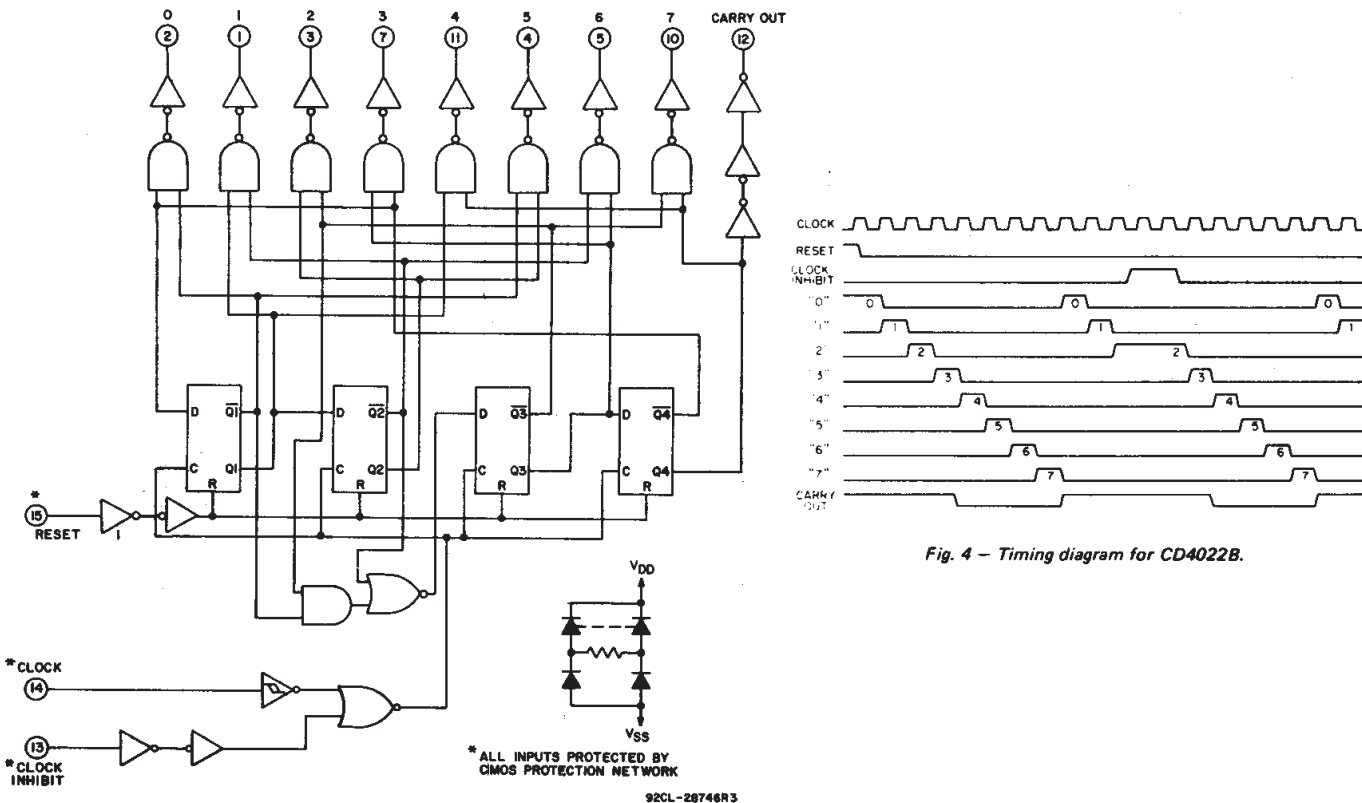

Fig. 4 - Timing diagram for CD4022B.

Fig. 3 - Logic diagram for CD4022B.

CD4017B, CD4022B Types

MAXIMUM RATINGS, Absolute-Maximum Values:

DC SUPPLY-VOLTAGE RANGE, (V_{DD})

Voltages referenced to V_{SS} Terminal) -0.5V to +20V

INPUT VOLTAGE RANGE, ALL INPUTS -0.5V to V_{DD}+0.5V

DC INPUT CURRENT, ANY ONE INPUT ±10mA

POWER DISSIPATION PER PACKAGE (P_D):

For T_A = -55°C to +100°C 500mW

For T_A = +100°C to +125°C Derate Linearity at 12mW/°C to 200mW

DEVICE DISSIPATION PER OUTPUT TRANSISTOR

FOR T_A = FULL PACKAGE-TEMPERATURE RANGE (All Package Types) 100mW

OPERATING-TEMPERATURE RANGE (T_A) -55°C to +125°C

STORAGE TEMPERATURE RANGE (T_{stg}) -65°C to +150°C

LEAD TEMPERATURE (DURING SOLDERING):

At distance 1/16 ± 1/32 inch (1.59 ± 0.79mm) from case for 10s max +265°C

STATIC ELECTRICAL CHARACTERISTICS

CHARACTERISTIC	CONDITIONS			LIMITS AT INDICATED TEMPERATURES (°C)							UNITS
	V _O (V)	V _{IN} (V)	V _{DD} (V)	-55	-40	+85	+125	+25			
								Min.	Typ.	Max.	
Quiescent Device Current, I _{DD} Max.	-	0.5	5	5	5	150	150	-	0.04	5	μA
	-	0.10	10	10	10	300	300	-	0.04	10	
	-	0.15	15	20	20	600	600	-	0.04	20	
	-	0.20	20	100	100	3000	3000	-	0.08	100	
Output Low (Sink) Current I _{OL} Min.	0.4	0.5	5	0.64	0.61	0.42	0.36	0.51	1	-	mA
	0.5	0.10	10	1.6	1.5	1.1	0.9	1.3	2.6	-	
	1.5	0.15	15	4.2	4	2.8	2.4	3.4	6.8	-	
Output High (Source) Current, I _{OH} Min.	4.6	0.5	5	-0.64	-0.61	-0.42	-0.36	-0.51	-1	-	mA
	2.5	0.5	5	-2	-1.8	-1.3	-1.15	-1.6	-3.2	-	
	9.5	0.10	10	-1.6	-1.5	-1.1	-0.9	-1.3	-2.6	-	
	13.5	0.15	15	-4.2	-4	-2.8	-2.4	-3.4	-6.8	-	
Output Voltage: Low-Level, V _{OL} Max.	-	0.5	5	0.05				-	0	0.05	V
	-	0.10	10	0.05				-	0	0.05	
	-	0.15	15	0.05				-	0	0.05	
Output Voltage: High-Level, V _{OH} Min.	-	0.5	5	4.95				4.95	5	-	V
	-	0.10	10	9.95				9.95	10	-	
	-	0.15	15	14.95				14.95	15	-	
Input Low Voltage V _{IL} Max.	0.5, 4.5	-	5	1.5				-	-	1.5	V
	1.9	-	10	3				-	-	3	
	1.5, 13.5	-	15	4				-	-	4	
Input High Voltage, V _{IH} Min.	0.5, 4.5	-	5	3.5				3.5	-	-	V
	1.9	-	10	7				7	-	-	
	1.5, 13.5	-	15	11				11	-	-	
Input Current I _{IN} Max.	-	0.18	18	±0.1	±0.1	±1	±1	-	±10 ⁻⁵	±0.1	μA

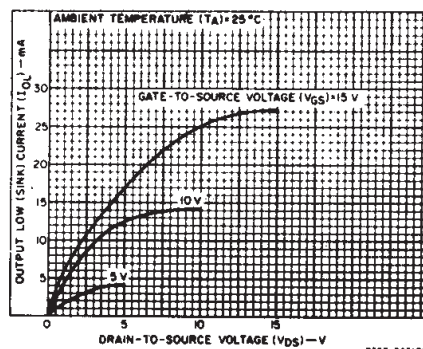

Fig. 5— Typical output low (sink) current characteristics.

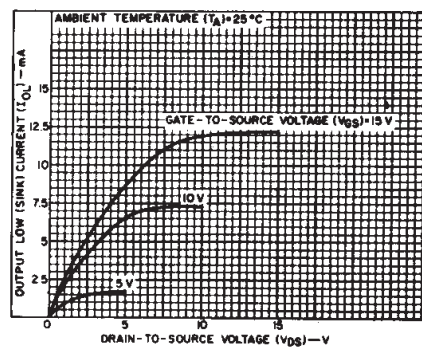

Fig. 6— Minimum output low (sink) current characteristics.

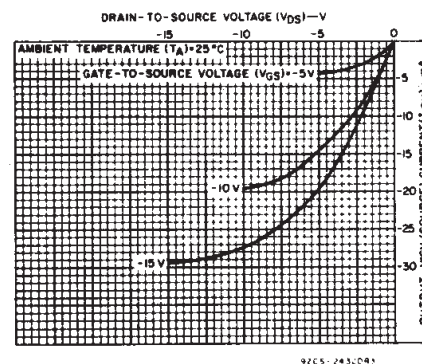

Fig. 7— Typical output high (source) current characteristics.

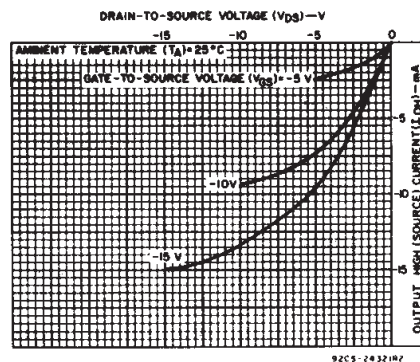

Fig. 8— Minimum output high (source) current characteristics.

3
COMMERCIAL CMOS
HIGH VOLTAGE ICs

CD4017B, CD4022B Types

DYNAMIC ELECTRICAL CHARACTERISTICS

At $T_A = 25^\circ\text{C}$, Input $t_r, t_f = 20 \text{ ns}$, $C_L = 50 \text{ pF}$, $R_L = 200 \text{ k}\Omega$

CHARACTERISTIC	CONDITIONS V_{DD} (V)	LIMITS			UNITS
		Min.	Typ.	Max.	
CLOCKED OPERATION					
Propagation Delay Time, t_{PHL}, t_{PLH} Decode Out	5	—	325	650	ns
	10	—	135	270	
	15	—	85	170	
Carry Out	5	—	300	600	ns
	10	—	125	250	
	15	—	80	160	
Transition Time, t_{THL}, t_{TLH} Carry Out or Decode Out Line	5	—	100	200	ns
	10	—	50	100	
	15	—	40	80	
Maximum Clock Input Frequency, f_{CL}^*	5	2.5	5	—	MHz
	10	5	10	—	
	15	5.5	11	—	
Minimum Clock Pulse Width, t_W	5	—	100	200	ns
	10	—	45	90	
	15	—	30	60	
Clock Rise or Fall Time, t_r, t_f	5, 10, 15	UNLIMITED			
Minimum Clock Inhibit to Clock Setup Time, t_s	5	—	115	230	ns
	10	—	50	100	
	15	—	35	70	
Input Capacitance, C_{IN}	Any Input	—	5	—	pF
RESET OPERATION					
Propagation Delay Time, t_{PHL}, t_{PLH} Carry Out or Decode Out Lines	5	—	265	530	ns
	10	—	115	230	
	15	—	85	170	
Minimum Reset Pulse Width, t_W	5	—	130	260	ns
	10	—	55	110	
	15	—	30	60	
Minimum Reset Removal Time	5	—	200	400	ns
	10	—	140	280	
	15	—	75	150	

* Measured with respect to carry output line.



Fig. 9 - Propagation delay, setup, and reset removal time waveforms.



Fig. 10 - Typical transition time as a function of load capacitance.

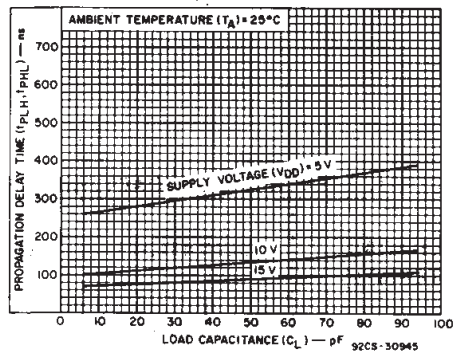

Fig. 11 - Typical propagation delay time as a function of load capacitance (clock to decode output).

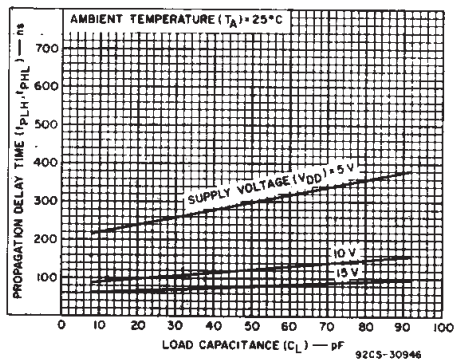

Fig. 12 - Typical propagation delay time as a function of load capacitance (clock to carry-out).



Fig. 13 - Typical dynamic power dissipation as a function of clock input frequency.

CD4017B, CD4022B Types



Fig. 14 - Quiescent device-current test circuit.



Fig. 15 - Input-leakage current.



Fig. 16 - Input-voltage test circuit.



Fig. 17 - Dynamic power dissipation test circuit.

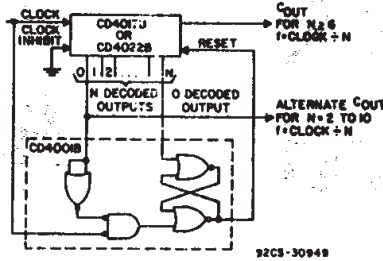

Fig. 18 - Divide by N counter ($N \leq 10$) with N decoded outputs.

When the N^{th} decoded output is reached (N^{th} clock pulse) the S-R flip flop (constructed from two NOR gates of the CD4001B) generates a reset pulse which clears the CD4017B or CD4022B to its zero count. At this time, if the N^{th} decoded output is greater than or equal to 6 in the CD4017B or 5 in the CD4022B; the C_{OUT} line goes high to clock the next CD4017B or CD4022B counter section. The "0" decoded output also goes high at this time. Coincidence of the clock low and decoded "0" output low resets the S-R flip flop to enable the CD4017B or CD4022B. If the N^{th} decoded output is less than 6 (CD4017B) or 5 (CD4022B), the C_{OUT} line will not go high and, therefore, cannot be used. In this case "0" decoded output may be used to perform the clocking function for the next counter.



Fig. 19 - Cascading the CD4017B.

3
COMMERCIAL CMOS
HIGH VOLTAGE ICs

CD4017B, CD4022B Types

CHIP DIMENSIONS AND PAD LAYOUTS



CD4017BH



CD4022BH

Dimensions in parentheses are in millimeters and are derived from the basic inch dimensions as indicated. Grid graduations are in mils (10^{-3} inch).

PACKAGING INFORMATION

Orderable Device	Status (1)	Package Type	Package Drawing	Pins	Package Qty	Eco Plan (2)	Lead finish/ Ball material (6)	MSL Peak Temp (3)	Op Temp (°C)	Device Marking (4/5)	Samples
CD4017BE	ACTIVE	PDIP	N	16	25	RoHS & Green	NIPDAU	N / A for Pkg Type	-55 to 125	CD4017BE	Samples
CD4017BEE4	ACTIVE	PDIP	N	16	25	RoHS & Green	NIPDAU	N / A for Pkg Type	-55 to 125	CD4017BE	Samples
CD4017BF	ACTIVE	CDIP	J	16	1	Non-RoHS & Green	SNPB	N / A for Pkg Type	-55 to 125	CD4017BF	Samples
CD4017BF3A	ACTIVE	CDIP	J	16	1	Non-RoHS & Green	SNPB	N / A for Pkg Type	-55 to 125	CD4017BF3A	Samples
CD4017BM96	ACTIVE	SOIC	D	16	2500	RoHS & Green	NIPDAU	Level-1-260C-UNLIM	-55 to 125	CD4017BM	Samples
CD4017BM96G4	ACTIVE	SOIC	D	16	2500	RoHS & Green	NIPDAU	Level-1-260C-UNLIM	-55 to 125	CD4017BM	Samples
CD4017BNSR	ACTIVE	SO	NS	16	2000	RoHS & Green	NIPDAU	Level-1-260C-UNLIM	-55 to 125	CD4017B	Samples
CD4017BPWR	ACTIVE	TSSOP	PW	16	2000	RoHS & Green	NIPDAU	Level-1-260C-UNLIM	-55 to 125	CM017B	Samples
CD4017BPWRE4	ACTIVE	TSSOP	PW	16	2000	RoHS & Green	NIPDAU	Level-1-260C-UNLIM	-55 to 125	CM017B	Samples
CD4022BE	ACTIVE	PDIP	N	16	25	RoHS & Green	NIPDAU	N / A for Pkg Type	-55 to 125	CD4022BE	Samples
CD4022BEE4	ACTIVE	PDIP	N	16	25	RoHS & Green	NIPDAU	N / A for Pkg Type	-55 to 125	CD4022BE	Samples
CD4022BF	ACTIVE	CDIP	J	16	1	Non-RoHS & Green	SNPB	N / A for Pkg Type	-55 to 125	CD4022BF	Samples
CD4022BF3A	ACTIVE	CDIP	J	16	1	Non-RoHS & Green	SNPB	N / A for Pkg Type	-55 to 125	CD4022BF3A	Samples
CD4022BNSR	ACTIVE	SO	NS	16	2000	RoHS & Green	NIPDAU	Level-1-260C-UNLIM	-55 to 125	CD4022B	Samples
CD4022BPW	ACTIVE	TSSOP	PW	16	90	RoHS & Green	NIPDAU	Level-1-260C-UNLIM	-55 to 125	CM022B	Samples
CD4022BPWR	ACTIVE	TSSOP	PW	16	2000	RoHS & Green	NIPDAU	Level-1-260C-UNLIM	-55 to 125	CM022B	Samples
JM38510/05651BEA	ACTIVE	CDIP	J	16	1	Non-RoHS & Green	SNPB	N / A for Pkg Type	-55 to 125	JM38510/ 05651BEA	Samples
M38510/05651BEA	ACTIVE	CDIP	J	16	1	Non-RoHS & Green	SNPB	N / A for Pkg Type	-55 to 125	JM38510/ 05651BEA	Samples

⁽¹⁾ The marketing status values are defined as follows:

ACTIVE: Product device recommended for new designs.

LIFEBUY: TI has announced that the device will be discontinued, and a lifetime-buy period is in effect.

NRND: Not recommended for new designs. Device is in production to support existing customers, but TI does not recommend using this part in a new design.

PREVIEW: Device has been announced but is not in production. Samples may or may not be available.

OBSOLETE: TI has discontinued the production of the device.

⁽²⁾ **RoHS:** TI defines "RoHS" to mean semiconductor products that are compliant with the current EU RoHS requirements for all 10 RoHS substances, including the requirement that RoHS substance do not exceed 0.1% by weight in homogeneous materials. Where designed to be soldered at high temperatures, "RoHS" products are suitable for use in specified lead-free processes. TI may reference these types of products as "Pb-Free".

RoHS Exempt: TI defines "RoHS Exempt" to mean products that contain lead but are compliant with EU RoHS pursuant to a specific EU RoHS exemption.

Green: TI defines "Green" to mean the content of Chlorine (Cl) and Bromine (Br) based flame retardants meet JS709B low halogen requirements of <=1000ppm threshold. Antimony trioxide based flame retardants must also meet the <=1000ppm threshold requirement.

⁽³⁾ MSL, Peak Temp. - The Moisture Sensitivity Level rating according to the JEDEC industry standard classifications, and peak solder temperature.

⁽⁴⁾ There may be additional marking, which relates to the logo, the lot trace code information, or the environmental category on the device.

⁽⁵⁾ Multiple Device Markings will be inside parentheses. Only one Device Marking contained in parentheses and separated by a "~" will appear on a device. If a line is indented then it is a continuation of the previous line and the two combined represent the entire Device Marking for that device.

⁽⁶⁾ Lead finish/Ball material - Orderable Devices may have multiple material finish options. Finish options are separated by a vertical ruled line. Lead finish/Ball material values may wrap to two lines if the finish value exceeds the maximum column width.

Important Information and Disclaimer:The information provided on this page represents TI's knowledge and belief as of the date that it is provided. TI bases its knowledge and belief on information provided by third parties, and makes no representation or warranty as to the accuracy of such information. Efforts are underway to better integrate information from third parties. TI has taken and continues to take reasonable steps to provide representative and accurate information but may not have conducted destructive testing or chemical analysis on incoming materials and chemicals. TI and TI suppliers consider certain information to be proprietary, and thus CAS numbers and other limited information may not be available for release.

In no event shall TI's liability arising out of such information exceed the total purchase price of the TI part(s) at issue in this document sold by TI to Customer on an annual basis.

OTHER QUALIFIED VERSIONS OF CD4017B, CD4017B-MIL, CD4022B, CD4022B-MIL :

● Catalog : [CD4017B](#), [CD4022B](#)

● Military : [CD4017B-MIL](#), [CD4022B-MIL](#)

NOTE: Qualified Version Definitions:

● Catalog - TI's standard catalog product

- Military - QML certified for Military and Defense Applications

TAPE AND REEL INFORMATION

QUADRANT ASSIGNMENTS FOR PIN 1 ORIENTATION IN TAPE

*All dimensions are nominal

Device	Package Type	Package Drawing	Pins	SPQ	Reel Diameter (mm)	Reel Width W1 (mm)	A0 (mm)	B0 (mm)	K0 (mm)	P1 (mm)	W (mm)	Pin1 Quadrant
CD4017BM96	SOIC	D	16	2500	330.0	16.4	6.5	10.3	2.1	8.0	16.0	Q1
CD4017BNSR	SO	NS	16	2000	330.0	16.4	8.2	10.5	2.5	12.0	16.0	Q1
CD4017BPWR	TSSOP	PW	16	2000	330.0	12.4	6.9	5.6	1.6	8.0	12.0	Q1
CD4022BNSR	SO	NS	16	2000	330.0	16.4	8.2	10.5	2.5	12.0	16.0	Q1
CD4022BPWR	TSSOP	PW	16	2000	330.0	12.4	6.9	5.6	1.6	8.0	12.0	Q1

TAPE AND REEL BOX DIMENSIONS

*All dimensions are nominal

Device	Package Type	Package Drawing	Pins	SPQ	Length (mm)	Width (mm)	Height (mm)
CD4017BM96	SOIC	D	16	2500	340.5	336.1	32.0
CD4017BNSR	SO	NS	16	2000	356.0	356.0	35.0
CD4017BPWR	TSSOP	PW	16	2000	356.0	356.0	35.0
CD4022BNSR	SO	NS	16	2000	356.0	356.0	35.0
CD4022BPWR	TSSOP	PW	16	2000	356.0	356.0	35.0

TUBE

*All dimensions are nominal

Device	Package Name	Package Type	Pins	SPQ	L (mm)	W (mm)	T (μm)	B (mm)
CD4017BE	N	PDIP	16	25	506	13.97	11230	4.32
CD4017BE	N	PDIP	16	25	506	13.97	11230	4.32
CD4017BEE4	N	PDIP	16	25	506	13.97	11230	4.32
CD4017BEE4	N	PDIP	16	25	506	13.97	11230	4.32
CD4022BE	N	PDIP	16	25	506	13.97	11230	4.32
CD4022BE	N	PDIP	16	25	506	13.97	11230	4.32
CD4022BEE4	N	PDIP	16	25	506	13.97	11230	4.32
CD4022BEE4	N	PDIP	16	25	506	13.97	11230	4.32
CD4022BPW	PW	TSSOP	16	90	530	10.2	3600	3.5



PACKAGE OUTLINE

NS0016A

SOP - 2.00 mm max height

SOP



4220735/A 12/2021

NOTES:

1. All linear dimensions are in millimeters. Dimensions in parenthesis are for reference only. Dimensioning and tolerancing per ASME Y14.5M.
2. This drawing is subject to change without notice.
3. This dimension does not include mold flash, protrusions, or gate burrs. Mold flash, protrusions, or gate burrs shall not exceed 0.15 mm, per side.
4. This dimension does not include interlead flash. Interlead flash shall not exceed 0.25 mm, per side.

EXAMPLE BOARD LAYOUT

NS0016A

SOP - 2.00 mm max height

SOP



4220735/A 12/2021

NOTES: (continued)

5. Publication IPC-7351 may have alternate designs.

6. Solder mask tolerances between and around signal pads can vary based on board fabrication site.

EXAMPLE STENCIL DESIGN

NS0016A

SOP - 2.00 mm max height

SOP



SOLDER PASTE EXAMPLE
BASED ON 0.125 mm THICK STENCIL
SCALE:7X

4220735/A 12/2021

NOTES: (continued)

7. Laser cutting apertures with trapezoidal walls and rounded corners may offer better paste release. IPC-7525 may have alternate design recommendations.
8. Board assembly site may have different recommendations for stencil design.

D (R-PDSO-G16)

PLASTIC SMALL OUTLINE



- NOTES:
- A. All linear dimensions are in inches (millimeters).
 - B. This drawing is subject to change without notice.
 - C. Body length does not include mold flash, protrusions, or gate burrs. Mold flash, protrusions, or gate burrs shall not exceed 0.006 (0,15) each side.
 - D. Body width does not include interlead flash. Interlead flash shall not exceed 0.017 (0,43) each side.
 - E. Reference JEDEC MS-012 variation AC.

D (R-PDSO-G16)

PLASTIC SMALL OUTLINE



- NOTES:
- All linear dimensions are in millimeters.
 - This drawing is subject to change without notice.
 - Publication IPC-7351 is recommended for alternate designs.
 - Laser cutting apertures with trapezoidal walls and also rounding corners will offer better paste release. Customers should contact their board assembly site for stencil design recommendations. Refer to IPC-7525 for other stencil recommendations.
 - Customers should contact their board fabrication site for solder mask tolerances between and around signal pads.



4220204/A 02/2017

NOTES:

1. All linear dimensions are in millimeters. Any dimensions in parenthesis are for reference only. Dimensioning and tolerancing per ASME Y14.5M.
2. This drawing is subject to change without notice.
3. This dimension does not include mold flash, protrusions, or gate burrs. Mold flash, protrusions, or gate burrs shall not exceed 0.15 mm per side.
4. This dimension does not include interlead flash. Interlead flash shall not exceed 0.25 mm per side.
5. Reference JEDEC registration MO-153.

EXAMPLE BOARD LAYOUT

PW0016A

TSSOP - 1.2 mm max height

SMALL OUTLINE PACKAGE



LAND PATTERN EXAMPLE
EXPOSED METAL SHOWN
SCALE: 10X



4220204/A 02/2017

NOTES: (continued)

- 6. Publication IPC-7351 may have alternate designs.
- 7. Solder mask tolerances between and around signal pads can vary based on board fabrication site.

EXAMPLE STENCIL DESIGN

PW0016A

TSSOP - 1.2 mm max height

SMALL OUTLINE PACKAGE



SOLDER PASTE EXAMPLE
BASED ON 0.125 mm THICK STENCIL
SCALE: 10X

4220204/A 02/2017

NOTES: (continued)

8. Laser cutting apertures with trapezoidal walls and rounded corners may offer better paste release. IPC-7525 may have alternate design recommendations.
9. Board assembly site may have different recommendations for stencil design.

MECHANICAL DATA

NS (R-PDSO-G**)

PLASTIC SMALL-OUTLINE PACKAGE

14-PINS SHOWN



- NOTES:
- A. All linear dimensions are in millimeters.
 - B. This drawing is subject to change without notice.
 - C. Body dimensions do not include mold flash or protrusion, not to exceed 0,15.

J (R-GDIP-T**)

14 LEADS SHOWN

CERAMIC DUAL IN-LINE PACKAGE



DIM \ PINS **	14	16	18	20
A	0.300 (7,62) BSC	0.300 (7,62) BSC	0.300 (7,62) BSC	0.300 (7,62) BSC
B MAX	0.785 (19,94)	.840 (21,34)	0.960 (24,38)	1.060 (26,92)
B MIN	—	—	—	—
C MAX	0.300 (7,62)	0.300 (7,62)	0.310 (7,87)	0.300 (7,62)
C MIN	0.245 (6,22)	0.245 (6,22)	0.220 (5,59)	0.245 (6,22)



4040083/F 03/03

- NOTES:
- All linear dimensions are in inches (millimeters).
 - This drawing is subject to change without notice.
 - This package is hermetically sealed with a ceramic lid using glass frit.
 - Index point is provided on cap for terminal identification only on press ceramic glass frit seal only.
 - Falls within MIL STD 1835 GDIP1-T14, GDIP1-T16, GDIP1-T18 and GDIP1-T20.

N (R-PDIP-T**)

PLASTIC DUAL-IN-LINE PACKAGE

16 PINS SHOWN



- NOTES:
- A. All linear dimensions are in inches (millimeters).
 - B. This drawing is subject to change without notice.
 - Falls within JEDEC MS-001, except 18 and 20 pin minimum body length (Dim A).
 - The 20 pin end lead shoulder width is a vendor option, either half or full width.

IMPORTANT NOTICE AND DISCLAIMER

TI PROVIDES TECHNICAL AND RELIABILITY DATA (INCLUDING DATA SHEETS), DESIGN RESOURCES (INCLUDING REFERENCE DESIGNS), APPLICATION OR OTHER DESIGN ADVICE, WEB TOOLS, SAFETY INFORMATION, AND OTHER RESOURCES "AS IS" AND WITH ALL FAULTS, AND DISCLAIMS ALL WARRANTIES, EXPRESS AND IMPLIED, INCLUDING WITHOUT LIMITATION ANY IMPLIED WARRANTIES OF MERCHANTABILITY, FITNESS FOR A PARTICULAR PURPOSE OR NON-INFRINGEMENT OF THIRD PARTY INTELLECTUAL PROPERTY RIGHTS.

These resources are intended for skilled developers designing with TI products. You are solely responsible for (1) selecting the appropriate TI products for your application, (2) designing, validating and testing your application, and (3) ensuring your application meets applicable standards, and any other safety, security, regulatory or other requirements.

These resources are subject to change without notice. TI grants you permission to use these resources only for development of an application that uses the TI products described in the resource. Other reproduction and display of these resources is prohibited. No license is granted to any other TI intellectual property right or to any third party intellectual property right. TI disclaims responsibility for, and you will fully indemnify TI and its representatives against, any claims, damages, costs, losses, and liabilities arising out of your use of these resources.

TI's products are provided subject to [TI's Terms of Sale](#) or other applicable terms available either on [ti.com](https://www.ti.com) or provided in conjunction with such TI products. TI's provision of these resources does not expand or otherwise alter TI's applicable warranties or warranty disclaimers for TI products.

TI objects to and rejects any additional or different terms you may have proposed.

Mailing Address: Texas Instruments, Post Office Box 655303, Dallas, Texas 75265
Copyright © 2023, Texas Instruments Incorporated