

# 具有一个 PLL、四个差分输出、两个输入和内部 EEPROM 的 CDCE6214-Q1 超低功耗时钟发生器

## 1 特性

- 符合面向汽车应用的 AEC-Q100 标准
  - 温度等级 2 : -40°C 至 +105°C
- 提供功能安全
  - 可帮助进行功能安全系统设计的文档
- 通过 RMS 抖动和杂散 ( 12kHz - 20MHz ,  $F_{out} > 100\text{MHz}$  ) 可将高性能、低功耗分数 N PLL 配置如下:
  - 整数模式:
    - 差分输出: 典型值 350fs, 最大值 600fs
    - LVC MOS 输出: 典型值 1.05ps, 最大值 1.5ps
  - 分数模式:
    - 差分输出: 典型值 1.7ps, 最大值 2.1ps
    - LVC MOS 输出: 典型值 2.0ps, 最大值 4.0ps
- 支持有 SSC 的 PCIe Gen1/2/3/4 和无 SSC 的 Gen 1/2/3/4/5
- 内部 VCO 频率范围为 2.335GHz 至 2.625GHz
- 典型功耗: 4 输出通道为 65mA, 单输出通道为 23mA。
- 通用时钟输入、两个用于提供冗余支持的基准输入
  - 差分交流耦合或 LVC MOS : 10MHz 至 200MHz
  - 晶振: 10MHz 至 50MHz
- 灵活的输出时钟分配
  - 4 通道分频器: 多达 5 个独特输出频率, 范围为 24kHz 至 328.125MHz
  - OUT0 - OUT4 引脚具有类似 LVDS、LP-HCSL 或 LVC MOS 输出
  - 无毛刺输出分频器切换和输出通道同步
  - 通过 GPIO 和寄存器实现独立输出使能端
- 频率裕量选项
  - DCO 模式: 频率以 10ppb 或更小的阶跃幅度递增/递减
- 完全集成的可配置环路带宽: 100kHz 至 1.6MHz
- 单电源或混合电源可进行电平转换: 1.8V/2.5V/3.3V
- 可配置 GPIO 和灵活配置选项

- 兼容 I<sup>2</sup>C 的接口: 频率高达 400kHz
- 具有两个页面和外部选择引脚的集成 EEPROM。可现场编程。

- 支持 100 Ω 系统
- 电磁辐射低
- 小尺寸: 24 引脚 VQFN (4mm × 4mm)

## 2 应用

- PCIe 第 1 至 5 代时钟
- 高级驾驶辅助系统 (ADAS) - 传感器融合
- 信息娱乐和仪表组 - 汽车音响主机 - eAVB
- 数据中心和企业计算、PC 与笔记本电脑
- 企业机器 - 多功能打印机
- 测试和测量、手持设备

## 3 说明

CDCE6214-Q1 是一款适合汽车应用的四通道、超低功耗、中级抖动时钟发生器, 可生成五个在各种驱动器模式之间可选的独立时钟输出。输入源可以是单端或差分输入时钟源, 也可以是晶振。CDCE6214-Q1 具有一个分数 N PLL, 可在任何输入频率下合成不相关的基础频率。CDCE6214-Q1 可通过 I<sup>2</sup>C 接口进行配置。无串行接口时, 可以在引脚模式下将 GPIO 引脚用于对产品进行独特配置。

### 器件信息(1)

器件型号	封装	封装尺寸 (标称值)
CDCE6214-Q1	VQFN (24)	4.00mm × 4.00mm

- (1) 如需了解所有可用封装, 请参阅数据表末尾的可订购产品附录。

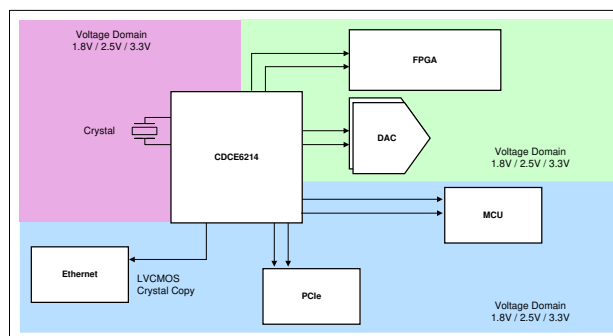

### 应用示例 CDCE6214-Q1



## Table of Contents

<b>1 特性</b> .....	1	7.25 Typical Characteristics.....	13
<b>2 应用</b> .....	1	<b>8 Parameter Measurement Information</b> .....	15
<b>3 说明</b> .....	1	8.1 Reference Inputs.....	15
<b>4 Revision History</b> .....	2	8.2 Outputs.....	15
<b>5 说明 (续)</b> .....	3	8.3 Serial Interface.....	16
<b>6 Pin Configuration and Functions</b> .....	3	8.4 PSNR Test.....	16
<b>7 Specifications</b> .....	5	8.5 Clock Interfacing and Termination.....	16
7.1 Absolute Maximum Ratings.....	5	<b>9 Detailed Description</b> .....	18
7.2 ESD Ratings.....	5	9.1 Overview.....	18
7.3 Recommended Operating Conditions.....	5	9.2 Functional Block Diagram.....	18
7.4 Thermal Information.....	5	9.3 Feature Description.....	18
7.5 EEPROM Characteristics.....	6	9.4 Device Functional Modes.....	30
7.6 Reference Input, Single-Ended Characteristics.....	6	9.5 Programming.....	30
7.7 Reference Input, Differential Characteristics.....	6	<b>10 Application and Implementation</b> .....	39
7.8 Reference Input, Crystal Mode Characteristics.....	6	10.1 Application Information.....	39
7.9 General-Purpose Input Characteristics.....	7	10.2 Typical Application.....	40
7.10 Triple Level Input Characteristics.....	7	<b>11 Power Supply Recommendations</b> .....	42
7.11 Logic Output Characteristics.....	7	11.1 Power-Up Sequence.....	42
7.12 Phase Locked Loop Characteristics.....	7	11.2 Decoupling.....	42
7.13 Closed-Loop Output Jitter Characteristics.....	8	<b>12 Layout</b> .....	43
7.14 Input and Output Isolation.....	8	12.1 Layout Guidelines.....	43
7.15 Buffer Mode Characteristics.....	8	12.2 Layout Examples.....	43
7.16 PCIe Spread Spectrum Generator.....	8	<b>13 Device and Documentation Support</b> .....	45
7.17 LVCMOS Output Characteristics.....	9	13.1 Device Support.....	45
7.18 LP-HCSL Output Characteristics.....	9	13.2 接收文档更新通知.....	45
7.19 LVDS Output Characteristics.....	10	13.3 支持资源.....	45
7.20 Output Synchronization Characteristics.....	10	13.4 Trademarks.....	45
7.21 Power-On Reset Characteristics.....	10	13.5 Electrostatic Discharge Caution.....	45
7.22 I <sup>2</sup> C-Compatible Serial Interface Characteristics.....	11	13.6 术语表.....	45
7.23 Timing Requirements, I <sup>2</sup> C-Compatible Serial Interface.....	11	<b>14 Mechanical, Packaging, and Orderable Information</b> .....	45
7.24 Power Supply Characteristics.....	11		

## 4 Revision History

注：以前版本的页码可能与当前版本的页码不同

Changes from Revision A (December 2019) to Revision B (October 2021)	Page
• 向特性部分添加了功能安全要点.....	1

---

Changes from Revision * (August 2019) to Revision A (December 2019)	Page
• 将数据表状态从“预告信息”更改为：量产数据.....	1

## 5 说明 (续)

片上 EEPROM 可用于更改配置，通过引脚可预选配置。该器件可提供频率裕量选项和无干扰运行功能，以支持系统设计验证测试 (DVT) 和以太网音频/视频桥接 (eAVB)。通过将分数反馈分频器转为 DCO 模式，任何输出通道上均可使用精细频率裕量。

内部电源调节功能可提供出色的电源纹波抑制 (PSRR)，从而降低供电网络的成本和复杂性。模拟和数字核心块由 1.8V、2.5V 或 3.3V  $\pm 5\%$  电源供电运行，输出块由 1.8V、2.5V 或 3.3V  $\pm 5\%$  电源供电运行。

CDCE6214-Q1 采用小外形封装，具有超低功耗，可根据单个基准实现高性能时钟树。工厂和用户可编程的 EEPROM 特性使得 CDCE6214-Q1 成为一款低功耗、方便易用、瞬时启动的时钟器件。

## 6 Pin Configuration and Functions



图 6-1. CDCE6214-Q1 RGE Package 24-Pin VQFN Top View

表 6-1. Pin Functions

PIN		I/O <sup>(1)</sup>	DESCRIPTION
NAME	NO.		
<b>POWER</b>			
DAP	—	G	Die Attach Pad. The DAP is an electrical connection and provides a thermal dissipation path. For proper electrical and thermal performance of the device, the DAP must be connected to PCB ground plane.
VDD_REF	3	P	1.8 V/2.5 V/3.3 V Power Supply for Reference Input and Digital.
VDD_VCO	24	P	1.8 V/2.5 V/3.3 V Power Supply for PLL/VCO.
VDDO_12	16	P	1.8 V/2.5 V/3.3 V Power Supply for OUT1 and OUT2 channels
VDDO_34	15	P	1.8 V/2.5 V/3.3 V Power Supply for OUT0, OUT3, and OUT4 channels
<b>INPUT BLOCK</b>			
HW_SW_CTRL RL	23	I, R <sub>PUPD</sub>	Manual selection pin for EEPROM pages (3-state). Weak Pullup/Pulldown. R <sub>PU</sub> = 50 k $\Omega$ . R <sub>PD</sub> = 50 k $\Omega$ .

表 6-1. Pin Functions (continued)

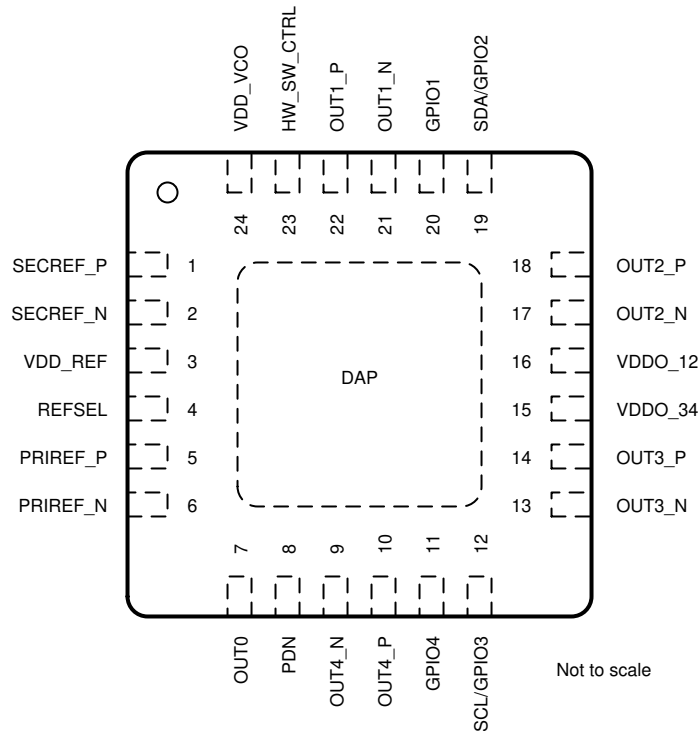
PIN		I/O <sup>(1)</sup>	DESCRIPTION
NAME	NO.		
PRIREF_P	5	I	Primary reference clock. Accepts a differential or single-ended input. Input pins need AC-coupling capacitors and internally biased in differential mode. For LVCMOS, input should be provided on PRIREF_P and the non-driven input pin should be pulled down to ground. Internal biasing for differential mode is disabled in single-ended mode.
PRIREF_N	6	I	
REFSEL	4	I, R <sub>PUPD</sub>	Manual selection pin of reference input (3-state). Weak Pullup/Pulldown. R <sub>PU</sub> = 50 k $\Omega$ . R <sub>PD</sub> = 50 k $\Omega$ .
SECREP_P	1	I	Secondary reference clock. Accepts a differential or single-ended input or XTAL. Input pins need AC-coupling capacitors and internally biased in differential mode. For XTAL input, connect crystal between SECREP_P and SECREP_N pin. SECREP_P is XOUT, SECREP_N is XIN. This device do not need any power limiting resistor on XOUT. For LVCMOS input, input should be provided on SECREP_P, and the non-driven input pin should be pulled down to ground. Internal biasing for differential mode is disabled in single-ended and XTAL mode.
SECREP_N	2		
<b>OUTPUT BLOCK</b>			
OUT0	7	O	LVCMOS Output 0. Reference Input can be bypassed into this output. Output slew-rate configurable on all LVCMOS outputs.
OUT1_P	22	O	LVDS-like/LP-HCSL/LVCMOS Output Pair 1. Programmable driver with LVDS-like/LP-HCSL or 2x LVCMOS outputs.
OUT1_N	21		
OUT2_P	18	O	LVDS-like/LP-HCSL Output Pair 2. Programmable driver with LVDS-like/LP-HCSL outputs.
OUT2_N	17		
OUT3_P	14	O	LVDS-like/LP-HCSL Output Pair 3. Programmable driver with LVDS-like/LP-HCSL outputs.
OUT3_N	13		
OUT4_P	10	O	LVDS-like/LP-HCSL/LVCMOS Output Pair 4. Programmable driver with LVDS-like/LP-HCSL or 2x LVCMOS outputs.
OUT4_N	9		
<b>DIGITAL CONTROL / INTERFACES</b>			
GPIO1	20	I/O, R <sub>PU</sub>	STATUS output or GPIO1 input. Weak pullup resistor when configured as Input. R <sub>PU</sub> = 50 k $\Omega$ . Pullup resistor disabled in output mode.
GPIO4	11	I/O, R <sub>PU</sub>	STATUS output or GPIO4 input. Weak pullup resistor when configured as Input. R <sub>PU</sub> = 50 k $\Omega$ . Pullup resistor disabled in output mode.
PDN	8	I, R <sub>PU</sub>	Device Power-down/RESET (active low) or SYNCN. Weak pullup resistor. R <sub>PU</sub> = 50 k $\Omega$ . Pullup resistor disabled in output mode.
SDA/GPIO2	19	I/O	I <sup>2</sup> C Serial Data (bidirectional, open-drain) or GPIO2 input. Requires an external pullup resistor to VDD_REF in I <sup>2</sup> C mode. I <sup>2</sup> C slave address is initialized from on-chip EEPROM. Fail-safe Input.
SCL/GPIO3	12	I	I <sup>2</sup> C Serial Clock or GPIO3 input. Requires an external pullup resistor to VDD_REF in I <sup>2</sup> C mode. Fail-safe Input.

(1) Type:

- G = Ground
- P = Power
- I = Input
- I/O = Input/Output
- O = Output
- I, RPUPD = Input with Resistive Pullup and Pulldown
- I, RPU = Input with Resistive Pullup
- I/O, RPU = Input/Output with Resistive Pullup

## 7 Specifications

### 7.1 Absolute Maximum Ratings

over operating free-air temperature range (unless otherwise noted)<sup>(1)</sup>

		MIN	MAX	UNIT
VDD_REF, VDD_VCO, VDDO_12, VDDO_34	Supply Voltage	-0.3	3.63	V
PRIREF_P, PRIREF_N, SECREP_P, SECREP_N	Input Voltage	-0.3	VDD_REF + 0.3	V
GPIO1, SDA/GPIO2, SCL/GPIO3, GPIO4, REFSEL, HW_SW_CTRL, PDN	Input Voltage	-0.3	VDD_REF + 0.3	V
OUT0, OUT1_P, OUT1_N, OUT2_P, OUT2_N, OUT3_P, OUT3_N, OUT4_P, OUT4_N <sup>(2)</sup>	Output Voltage	-0.3	VDDO_X <sup>(2)</sup> + 0.3	V
T <sub>J</sub>	Junction Temperature		125	°C
T <sub>stg</sub>	Storage temperature	-65	150	°C

(1) Stresses beyond those listed under *Absolute Maximum Ratings* may cause permanent damage to the device. These are stress ratings only, which do not imply functional operation of the device at these or any other conditions beyond those indicated under *Recommended Operating Conditions*. Exposure to absolute-maximum-rated conditions for extended periods may affect device reliability.

(2) VDDO\_X refers to the output supply for a specific output channel, where X denotes the channel index.

### 7.2 ESD Ratings

			VALUE	UNIT
V <sub>(ESD)</sub>	Electrostatic discharge	Human-body model (HBM), per AEC Q100-002, HBM ESD Classification Level 2 <sup>(1)</sup>	2000	V
		Charged-device model (CDM), per AEC Q100-011 CDM ESD Classification Level C5	750	V

(1) AEC Q100-002 indicates that HBM stressing shall be in accordance with the ANSI/ESDA/JEDEC JS-001 specification.

### 7.3 Recommended Operating Conditions

over operating free-air temperature range (unless otherwise noted)

		MIN	NOM	MAX	UNIT
VDD_VCO	Core supply voltage	1.71	1.8, 2.5, 3.3	3.465	V
VDDO_12, VDDO_34	Output supply voltage	1.71	1.8, 2.5, 3.3	3.465	V
VDD_REF	Reference supply voltage	1.71	1.8, 2.5, 3.3	3.465	V
T <sub>A</sub>	Ambient temperature	-40		105	°C
T <sub>J</sub>	Junction temperature	-40		125	°C
T <sub>LOCK</sub>	Continuous lock over temperature (without VCO calibration)			145	°C
t <sub>RAMP</sub>	Maximum supply voltage ramp time <sup>(1)</sup>	0.1		30	ms

(1) VDD pin should monotonically reach 95% of its final value within supply ramp time. All VDD pins were tied together for this evaluation. For non-monotonic or slower power supply ramp, it is recommended to pull-down PDN pin until VDD pins have reached 95% of its final value. PDN pin has a 50 kΩ pullup resistor. When PDN pin cannot be actively controlled, TI recommends to add a capacitor to GND on PDN pin to delay the release of reset.

### 7.4 Thermal Information

THERMAL METRIC <sup>(1)</sup>		CDCE6214-Q1	UNIT
		RGE (VQFN)	
		24 PINS	
R <sub>θJA</sub>	Junction-to-ambient thermal resistance	32.5	°C/W
R <sub>θJC(top)</sub>	Junction-to-case (top) thermal resistance	32.5	°C/W
R <sub>θJB</sub>	Junction-to-board thermal resistance	12.2	°C/W
R <sub>θJC(bot)</sub>	Junction-to-case (bottom) thermal resistance	2.0	°C/W
ψ <sub>JT</sub>	Junction-to-top characterization parameter	0.4	°C/W

THERMAL METRIC <sup>(1)</sup>		CDCE6214-Q1	UNIT
		RGE (VQFN)	
		24 PINS	
$\psi_{JB}$	Junction-to-board characterization parameter	12.2	°C/W

(1) For more information about traditional and new thermal metrics, see the [Semiconductor and IC Package Thermal Metrics](#) application report, SPRA953.

## 7.5 EEPROM Characteristics

VDD\_VCO, VDDO\_12, VDDO\_34, VDD\_REF = 1.8 V ± 5%, 2.5 V ± 5%, 3.3 V ± 5% and T<sub>A</sub> = -40°C to 105°C

PARAMETER	TEST CONDITIONS	MIN	TYP	MAX	UNIT
$\eta_{EEcyc}$	EEPROM programming cycles	each word	10		cycles
$t_{EEret}$	EEPROM data retention		10		years

## 7.6 Reference Input, Single-Ended Characteristics

VDD\_VCO, VDDO\_12, VDDO\_34, VDD\_REF = 1.8 V ± 5%, 2.5 V ± 5%, 3.3 V ± 5% and T<sub>A</sub> = -40°C to 105°C

PARAMETER	TEST CONDITIONS	MIN	TYP	MAX	UNIT
$f_{IN\_Ref}$	Reference frequency	10		200	MHz
V <sub>IH</sub>	Input high voltage	LVC MOS Input Buffer	0.8 × VDD_REF		V
V <sub>IL</sub>	Input low voltage	LVC MOS Input Buffer		0.2 × VDD_REF	V
dV <sub>IN</sub> /dT	Input slew rate	20% - 80%	1		V/ns
IDC	Input duty cycle		40	60	%
I <sub>IN\_LEAKAGE</sub>	Input leakage current		-100	100	μA
C <sub>IN\_REF</sub>	Input capacitance	at 25°C		5	pF

## 7.7 Reference Input, Differential Characteristics

VDD\_VCO, VDDO\_12, VDDO\_34, VDD\_REF = 1.8 V ± 5%, 2.5 V ± 5%, 3.3 V ± 5% and T<sub>A</sub> = -40°C to 105°C

PARAMETER	TEST CONDITIONS	MIN	TYP	MAX	UNIT
$f_{IN\_Ref}$	Reference frequency	10		200	MHz
V <sub>IN\_DIFF</sub>	Differential input voltage swing, peak-to-peak	VDD_REF = 2.5 V/3.3 V	0.4	1.6	V
V <sub>IN\_DIFF</sub>	Differential input voltage swing, peak-to-peak	VDD_REF = 1.8 V	0.4	1.0	V
dV <sub>IN</sub> /dT	Input slew rate	20% - 80%	1		V/ns
IDC	Input duty cycle		40	60	%
I <sub>IN\_LEAKAGE</sub>	Input leakage current		-100	100	μA
C <sub>IN\_REF</sub>	Input capacitance	at 25°C		5	pF

## 7.8 Reference Input, Crystal Mode Characteristics

VDD\_VCO, VDDO\_12, VDDO\_34, VDD\_REF = 1.8 V ± 5%, 2.5 V ± 5%, 3.3 V ± 5% and T<sub>A</sub> = -40°C to 105°C<sup>(1)</sup>

PARAMETER	TEST CONDITIONS	MIN	TYP	MAX	UNIT
$f_{IN\_Xtal}$	Crystal frequency	Fundamental mode	10	50	MHz
Z <sub>ESR</sub>	Crystal equivalent series resistance	$f_{XTAL}$ = 10 MHz to 16 MHz		60	Ω
Z <sub>ESR</sub>	Crystal equivalent series resistance	$f_{XTAL}$ = 16 MHz to 30 MHz		50	Ω
Z <sub>ESR</sub>	Crystal equivalent series resistance	$f_{XTAL}$ = 30 MHz to 50 MHz		30	Ω
C <sub>L</sub>	Crystal load capacitance	Using on-chip load capacitance. A supported Crystal is within	5	12.8	pF
P <sub>XTAL</sub>	Crystal tolerated drive power	A supported crystal tolerates up to		200	μW
C <sub>XIN_LOAD</sub>	On-Chip load capacitance	Programmable in typ. 200 fF steps	3	9.1	pF

(1) For detailed application report on configuring the XTAL Input, please refer to [SNAA331: CDCI6214 and CDCE6214-Q1 design with crystal input](#).

## 7.9 General-Purpose Input Characteristics

VDD\_VCO, VDDO\_12, VDDO\_34, VDD\_REF = 1.8 V ± 5%, 2.5 V ± 5%, 3.3 V ± 5% and T<sub>A</sub> = -40°C to 105°C

PARAMETER		TEST CONDITIONS	MIN	TYP	MAX	UNIT
V <sub>IH</sub>	Input high voltage		0.8 × VDD_REF			V
V <sub>IL</sub>	Input low voltage				0.2 × VDD_REF	V
I <sub>IH</sub>	Input high level current	V <sub>IH</sub> = VDD_REF, GPIO[1:4], PDN	-5		5	μA
I <sub>IL</sub>	Input low level current	V <sub>IL</sub> = GND, GPIO[2:3]	-5		5	μA
I <sub>IL</sub>	Input low level current	V <sub>IL</sub> = GND, GPIO[1], GPIO[4], PDN	-100		100	μA
dV <sub>IN</sub> /dT	Input slew rate	20% - 80%	0.5			V/ns
T <sub>PULSE_WIDT H</sub>	Pulse width for correct operation		10			ns
R <sub>PU</sub>	Pullup Resistance	Pins PDN, GPIO[1], GPIO[4]	30	55	80	kΩ
C <sub>IN</sub>	Pin Capacitance				10	pF

## 7.10 Triple Level Input Characteristics

VDD\_VCO, VDDO\_12, VDDO\_34, VDD\_REF = 1.8 V ± 5%, 2.5 V ± 5%, 3.3 V ± 5% and T<sub>A</sub> = -40°C to 105°C

PARAMETER		TEST CONDITIONS	MIN	TYP	MAX	UNIT
V <sub>IH</sub>	Input high voltage		0.8 × VDD_REF			V
V <sub>IM</sub>	Input mid voltage	Float pin	0.41 × VDD_REF	0.5 × VDD_REF	0.58 × VDD_REF	V
V <sub>IL</sub>	Input low voltage				0.2 × VDD_REF	V
I <sub>IH</sub>	Input high level current	V <sub>IH</sub> = VDD_REF	20	50	100	μA
I <sub>IL</sub>	Input low level current	V <sub>IL</sub> = GND	-100	-50	-20	μA

## 7.11 Logic Output Characteristics

VDD\_VCO, VDDO\_12, VDDO\_34, VDD\_REF = 1.8 V ± 5%, 2.5 V ± 5%, 3.3 V ± 5% and T<sub>A</sub> = -40°C to 105°C

PARAMETER		TEST CONDITIONS	MIN	TYP	MAX	UNIT
VOH	Output high voltage		0.8 × VDD_REF			V
VOL	Output low voltage				0.2 × VDD_REF	V

## 7.12 Phase Locked Loop Characteristics

VDD\_VCO, VDDO\_12, VDDO\_34, VDD\_REF = 1.8 V ± 5%, 2.5 V ± 5%, 3.3 V ± 5% and T<sub>A</sub> = -40°C to 105°C

PARAMETER		TEST CONDITIONS	MIN	TYP	MAX	UNIT
f <sub>PDF</sub>	Phase Detector Frequency	Integer and Fractional PLL mode	1		100	MHz
f <sub>VCO</sub>	Voltage Controlled Oscillator Frequency		2335		2625	MHz
f <sub>BW</sub>	Configurable closed-loop PLL Bandwidth	REF = 25 MHz	100		1600	kHz
K <sub>VCO</sub>	Voltage-Controlled Oscillator Gain	f <sub>VCO</sub> = 2.4 GHz		140		MHz/V
K <sub>VCO</sub>	Voltage-Controlled Oscillator Gain	f <sub>VCO</sub> = 2.5 GHz		175		MHz/V
Δ T <sub>CL</sub>	Allowable Temperature Drift for Continuous Lock <sup>(1)</sup>	dT/dt ≤ 20 K / min			145	°C
f <sub>MAX-ERROR</sub>	Maximum frequency error with frac-N PLL				0.1	ppm

- (1) The maximum allowable temperature drift for continuous lock: how far the temperature can drift in either direction from the value it was at the time, when the On-Chip VCO was calibrated while the PLL stays in lock throughout the temperature drift. The internal VCO calibration takes place: at device start-up, when the device is reset using the RESET pin and when REGISTER bit is changed. This implies the device will work over the entire frequency range, but if the temperature drifts more than the 'maximum allowable temperature drift for continuous lock', then it is necessary to re-calibrate the VCO, using the appropriate REGISTER bit, to ensure the PLL stays in lock. Regardless of what temperature the part was initially calibrated at, the temperature can never drift outside the ambient temperature range of -40° C to 105° C.

### 7.13 Closed-Loop Output Jitter Characteristics

VDD\_VCO, VDDO\_12, VDDO\_34, VDD\_REF = 1.8 V ± 5%, 2.5 V ± 5%, 3.3 V ± 5% and T<sub>A</sub> = -40°C to 105°C

PARAMETER		TEST CONDITIONS	MIN	TYP	MAX	UNIT
t <sub>RJ_CL</sub>	RMS Phase Jitter	RMS jitter with spurs from 12 kHz to 20 MHz, Input Crystal = 25 MHz, Differential OUTx > 100 MHz, int-PLL		350	600	fs
t <sub>RJ_CL</sub>	RMS Phase Jitter <sup>(1)</sup>	RMS jitter with spurs from 12 kHz to 20 MHz, Input Crystal = 25 MHz, Differential OUTx > 100 MHz, frac-PLL		1600	2100	fs
t <sub>RJ_CL, PCIE</sub>	RMS Phase Jitter	PCIe Gen 3 Filter applied, XIN = Crystal 25 MHz, OUTx = 100 MHz, frac-N PLL with and without SSC, LP-HCSL or LVDS output		475	1000	fs

- (1) F<sub>IN</sub> = 25MHz, F<sub>OUT</sub> = 161.1328MHz, F<sub>PF</sub> = 25MHz, RMS Noise = 1.83ps. F<sub>IN</sub> = 25MHz, F<sub>OUT</sub> = 161.1328MHz, F<sub>PF</sub> = 50MHz, RMS Noise = 1.33ps. F<sub>IN</sub> = 25MHz, F<sub>OUT</sub> = 148.5MHz, F<sub>PF</sub> = 25MHz, RMS Noise = 1.74ps. F<sub>IN</sub> = 25MHz, F<sub>OUT</sub> = 148.5MHz, F<sub>PF</sub> = 50MHz, RMS Noise = 1.43ps. F<sub>IN</sub> = 25MHz, F<sub>OUT</sub> = 148.3516MHz, F<sub>PF</sub> = 25MHz, RMS Noise = 1.6ps. F<sub>IN</sub> = 25MHz, F<sub>OUT</sub> = 148.3516MHz, F<sub>PF</sub> = 50MHz, RMS Noise = 1.5ps. F<sub>IN</sub> = 25MHz, F<sub>OUT</sub> = 106.5MHz, F<sub>PF</sub> = 25MHz, RMS Noise = 0.8ps. F<sub>IN</sub> = 25MHz, F<sub>OUT</sub> = 106.5MHz, F<sub>PF</sub> = 50MHz, RMS Noise = 1.3ps.

### 7.14 Input and Output Isolation

VDD\_VCO, VDDO\_12, VDDO\_34, VDD\_REF = 1.8 V ± 5%, 2.5 V ± 5%, 3.3 V ± 5% and T<sub>A</sub> = -40°C to 105°C

PARAMETER		TEST CONDITIONS	MIN	TYP	MAX	UNIT
P <sub>ISOLATION</sub>	Reference input isolation	Crosstalk between reference inputs, PRIREF = 27MHz LVCMOS, SECREP = 25MHz XTAL		-64		dB
P <sub>ISOLATION</sub>	Reference input isolation	Crosstalk between reference inputs, PRIREF = 100MHz LVDS, SECREP = 25MHz LVCMOS		-72		dB
P <sub>ISOLATION</sub>	Clock output isolation	Crosstalk between clock outputs, OUT1 = 100MHz LP-HCSL, OUT2 = 156.25MHz LVDS, PFD = 25MHz, int-PLL		-65		dB
P <sub>ISOLATION</sub>	Clock output isolation	Crosstalk between clock outputs, OUT1 = 156.25MHz LVDS, OUT0 = 25MHz LVCMOS		-42		dB

### 7.15 Buffer Mode Characteristics

VDD\_VCO, VDDO\_12, VDDO\_34, VDD\_REF = 1.8 V ± 5%, 2.5 V ± 5%, 3.3 V ± 5% and T<sub>A</sub> = -40°C to 105°C

PARAMETER		TEST CONDITIONS	MIN	TYP	MAX	UNIT
t <sub>RJ_ADD</sub>	Additive RMS Phase Jitter, System Level	int. Range from 10 kHz to 20 MHz, REF = HCSL 100 MHz with 0.5 V/ns, OUTx = 100 MHz LP-HCSL			350	fs
t <sub>PROP, LVCMOS</sub>	Input-to-output propagation delay	REF = LVCMOS 25 MHz, OUTx = 25 MHz LVCMOS		1		ns
t <sub>PROP, Differential</sub>	Input-to-output propagation delay <sup>(1)</sup>	REF = AC-LVDS 100 MHz, OUTx = 100 MHz. Measured on OUT0		2.3		ns
t <sub>PROP-VARIATION</sub>	Input-to-output delay variation in ZDB mode	ZDB mode, LVCMOS input = LVCMOS output = 25 MHz, PLL BW = 300 kHz to 900 kHz across temperature	-400		400	ps

- (1) OUT1/OUT4 and OUT2/OUT3 are matched pair-wise. OUT1/OUT4 has LVCMOS buffer while OUT2/OUT3 do not have LVCMOS buffer. There is an additional skew 150 ps- 250 ps between OUT1/OUT4 and OUT2/OUT3.

### 7.16 PCIe Spread Spectrum Generator

VDD\_VCO, VDDO\_12, VDDO\_34, VDD\_REF = 1.8 V ± 5%, 2.5 V ± 5%, 3.3 V ± 5% and T<sub>A</sub> = -40°C to 105°C

PARAMETER		TEST CONDITIONS	MIN	TYP	MAX	UNIT
f <sub>SSC-RATE</sub>	SSC modulation rate	OUTx = 100 MHz	30	31.5	33	kHz
P <sub>AMPL-RED</sub>	SSC amplitude reduction	OUTx = 100 MHz, -0.25% Down spread		6.8		dB
P <sub>AMPL-RED</sub>	SSC amplitude reduction	OUTx = 100 MHz, -0.50% Down spread		9.9		dB
f <sub>SSC-STEP</sub>	Down and Center spread SSC step size	OUTx = 100 MHz		0.25		%



VDD\_VCO, VDDO\_12, VDDO\_34, VDD\_REF = 1.8 V ± 5%, 2.5 V ± 5%, 3.3 V ± 5% and T<sub>A</sub> = -40°C to 105°C

PARAMETER		TEST CONDITIONS	MIN	TYP	MAX	UNIT
f <sub>SSC_FREQ_DEVIATION</sub>	Down spread minimum/maximum deviation	OUTx = 100 MHz. F <sub>PFD</sub> = 25 MHz, 50 MHz, 100 MHz	-0.5		0	%
f <sub>SSC_FREQ_DEVIATION</sub>	Center spread minimum/maximum deviation	OUTx = 100 MHz. F <sub>PFD</sub> = 25 MHz, 50 MHz, 100 MHz	-0.5		0.5	%

## 7.17 LVCMOS Output Characteristics

VDD\_VCO, VDDO\_12, VDDO\_34, VDD\_REF = 1.8 V ± 5%, 2.5 V ± 5%, 3.3 V ± 5% and T<sub>A</sub> = -40°C to 105°C

PARAMETER		TEST CONDITIONS	MIN	TYP	MAX	UNIT
f <sub>O_LVCMOS</sub>	Output frequency	2 pF to GND, normal mode	0.024		200	MHz
V <sub>OH_LVCMOS</sub>	Output high voltage	I <sub>OH</sub> = 1 mA, VDDO_x is corresponding supply voltage.	0.8 × VDDO_x			V
V <sub>OL_LVCMOS</sub>	Output low voltage	I <sub>OL</sub> = 1 mA, VDDO_x is corresponding supply voltage.			0.2 × VDDO_x	V
I <sub>OH</sub>	Output high current	Vout = 0.8 × VDDO_x, VDDO_x = 1.8 V		-6		mA
I <sub>OH</sub>	Output high current	Vout = 0.8 × VDDO_x, VDDO_x = 2.5 V		-8.5		mA
I <sub>OH</sub>	Output high current	Vout = 0.8 × VDDO_x, VDDO_x = 3.3 V		-11.2		mA
I <sub>OL</sub>	Output low current	Vout = 0.2 × VDDO_x, VDDO_x = 1.8 V		6		mA
I <sub>OL</sub>	Output low current	Vout = 0.2 × VDDO_x, VDDO_x = 2.5 V		8.5		mA
I <sub>OL</sub>	Output low current	Vout = 0.2 × VDDO_x, VDDO_x = 3.3 V		11.2		mA
T <sub>RISE-FALL</sub>	Output rise/fall time	20/80%, C <sub>L</sub> = 5 pF, normal mode	300	500	700	ps
T <sub>RISE-FALL</sub>	Output rise/fall time	20/80%, C <sub>L</sub> = 5 pF, slow mode, measured on OUT0		1000		ps
T <sub>SKEW</sub>	Output-to-output skew <sup>(1)</sup>	LVCMOS-to-LVCMOS outputs, same divide value		100		ps
T <sub>SKEW</sub>	Output-to-output skew <sup>(1)</sup>	LVCMOS-to-Differential outputs, same divide value		400		ps
ODC	Output duty cycle	Not in PLL bypass mode	45		55	%
R <sub>ON_LVCMOS</sub>	Output impedance	Normal mode	45	60	75	Ω
R <sub>ON_LVCMOS</sub>	Output impedance	Slow mode	50	65	85	Ω

(1) OUT1/OUT4 and OUT2/OUT3 are matched pair-wise. OUT1/OUT4 has LVCMOS buffer while OUT2/OUT3 do not have LVCMOS buffer. OUT1/OUT4 is matched within T<sub>OUT-SKEW</sub>. OUT2/OUT3 is matched within T<sub>OUT-SKEW</sub>.

## 7.18 LP-HCSL Output Characteristics

VDD\_VCO, VDDO\_12, VDDO\_34, VDD\_REF = 1.8 V ± 5%, 2.5 V ± 5%, 3.3 V ± 5% and T<sub>A</sub> = -40°C to 105°C

PARAMETER		TEST CONDITIONS	MIN	TYP	MAX	UNIT
f <sub>O_HCSL</sub>	Output frequency		0.024		328.125	MHz
V <sub>OH</sub>	Output high voltage <sup>(3)</sup>		660		850	mV
V <sub>OL</sub>	Output low voltage		-150		150	mV
Z <sub>DIFF</sub>	Differential Output Impedance <sup>(3)</sup>		90	100	110	Ω
V <sub>CROSS</sub>	Absolute crossing point	12-in, 100 Ω ±10% diff. trace with 2 pF±5%/pin in FR4.	250		550	mV
ΔV <sub>CROSS</sub>	Relative crossing point variation	with respect to average crossing point			140	mV
dV/dt	Slew rate for rising and falling edge	differential, at V <sub>CROSS</sub> +/-150 mV, f <sub>O_HCSL</sub> =100 MHz <sup>(1)</sup>	1		4	V/ns
ΔdV/dt	Slew rate matching	single-ended, at V <sub>CROSS</sub> +/-75 mV, f <sub>O_HCSL</sub> =100 MHz <sup>(1)</sup>			20	%
V <sub>rb</sub>	Output ringback voltage	Measured on differential output at 100 MHz and specifies minimum voltage from zero crossing	-100		100	mV
T <sub>stable</sub>	Time elapsed until ringback	Minimum time until ringback is allowed	500			ps
ODC	Output duty cycle	Not in PLL bypass mode	45		55	%
T <sub>OUT-SKEW</sub>	Output skew <sup>(2)</sup>	Same divide value, LP-HCSL to LP-HCSL		100		ps

(1) PCIe test load slew rate

- (2) OUT1/OUT4 and OUT2/OUT3 are matched pair-wise. OUT1/OUT4 has LVCMOS buffer while OUT2/OUT3 do not have LVCMOS buffer. OUT1/OUT4 is matched within  $T_{OUT-SKEW}$ . OUT2/OUT3 is matched within  $T_{OUT-SKEW}$ . There is an additional skew 150 ps- 250 ps between OUT1/OUT4 and OUT2/OUT3.
- (3) Differential Output characteristic is trimmed in factory and trim settings are stored in EEPROM. Parameter not valid in Fall-back mode.

## 7.19 LVDS Output Characteristics

VDD\_VCO, VDDO\_12, VDDO\_34, VDD\_REF = 1.8 V  $\pm$  5%, 2.5 V  $\pm$  5%, 3.3 V  $\pm$  5% and  $T_A$  = -40°C to 105°C

PARAMETER		TEST CONDITIONS	MIN	TYP	MAX	UNIT
$f_{O\_PRG\_AC}$	Output frequency		0.024		328.125	MHz
$V_{CM}$	Output common mode <sup>(2)</sup>	VDDO_X = 2.5 V, 3.3 V	1.025	1.2	1.375	V
$V_{CM}$	Output common mode <sup>(2)</sup>	VDDO_X = 1.8 V	0.85	0.95	1.05	V
$V_{OD}$	Differential output voltage <sup>(2)</sup>	VDDO_X = 1.8 V ( $F_{out} < 200$ MHz), 2.5 V, 3.3 V.	0.25	0.30	0.45	V
$V_{OD}$	Differential output voltage <sup>(2)</sup>	VDDO_X = 1.8 V & $F_{out} > 200$ MHz	0.22	0.30	0.45	V
$t_{RF}$	Output rise/fall times	LVDS (20% to 80%)	450	650	900	ps
ODC	Output duty cycle	Not in PLL bypass mode	45		55	%
$T_{OUT-SKEW}$	Output skew <sup>(1)</sup>	Same divide value, LVDS to LVDS output		100		ps

- (1) OUT1/OUT4 and OUT2/OUT3 are matched pair-wise. OUT1/OUT4 has LVCMOS buffer while OUT2/OUT3 do not have LVCMOS buffer. OUT1/OUT4 is matched within  $T_{OUT-SKEW}$ . OUT2/OUT3 is matched within  $T_{OUT-SKEW}$ . There is an additional skew 150 ps- 250 ps between OUT1/OUT4 and OUT2/OUT3.
- (2) Output Common Mode voltage and Differential output swing is dependent upon register settings DIFFBUF\_IBIAS\_TRIM, LVDS\_CMTRIM\_DEC and LVDS\_CMTRIM\_INC. Parameters defined for DIFFBUF\_IBIAS\_TRIM=6h, LVDS\_CMTRIM\_DEC=0h and LVDS\_CMTRIM\_INC=0h. Output Common Mode tested at DC.

## 7.20 Output Synchronization Characteristics

VDD\_VCO, VDDO\_12, VDDO\_34, VDD\_REF = 1.8 V  $\pm$  5%, 2.5 V  $\pm$  5%, 3.3 V  $\pm$  5% and  $T_A$  = -40°C to 105°C

PARAMETER		TEST CONDITIONS	MIN	TYP	MAX	UNIT
$t_{SU\_SYNC}$	Setup time SYNC pulse	with respect to PLL reference rising edge at 100 MHz with R=1	3			ns
$t_{H\_SYNC}$	Hold time SYNC pulse	with respect to PLL reference rising edge at 100 MHz with R=1			3	ns
$t_{PWH\_SYNC}$	High pulse width for SYNC	With R = 1, at least 2 PFD periods + 24 feedback pre-scaler periods	60			ns
$t_{PWL\_SYNC}$	Low pulse width for SYNC	With R = 1, at least 1 PFD period	6			ns
$t_{EN}$	Individual output enable time <sup>(1)</sup>	tri-state to first valid rising edge			4	nCK
$t_{DIS}$	Individual output disable time <sup>(1)</sup>	last valid falling edge to tri-state			4	nCK

- (1) Output clock cycles of respective output channel. Global output enable handled by digital logic, additional propagation will be added.

## 7.21 Power-On Reset Characteristics

VDD\_VCO, VDDO\_12, VDDO\_34, VDD\_REF = 1.8 V  $\pm$  5%, 2.5 V  $\pm$  5%, 3.3 V  $\pm$  5% and  $T_A$  = -40°C to 105°C

PARAMETER		TEST CONDITIONS	MIN	TYP	MAX	UNIT
$V_{THRESHOLD}$	POR threshold voltage <sup>(1)</sup>		0.875		1.275	V
$t_{STARTUP}$	Start-up time	Start-up time after VDD reaches 95% to the time outputs are toggling with correct frequency (input = crystal or external clock)		9		ms
$t_{VDD}$	Power supply ramp time <sup>(2)</sup>	timing requirement for any VDD pin while PDN=LOW	0.1		30	ms

- (1) POR threshold voltage is the power supply voltage at which the internal reset is deasserted. It is qualified internally with PDN.
- (2) VDD pin should monotonically reach 95% of its final value within supply ramp time. Parameters specified by characterization. All VDD pins were tied together for this evaluation. For non-monotonic or slower power supply ramp, it is recommended to pull-down PDN pin until VDD pins have reached 95% of its final value. PDN pin has a 50 k $\Omega$  pullup resistor. When PDN pin cannot be actively controlled, TI recommends to add a capacitor to GND on PDN pin to delay the release of reset.

## 7.22 I<sup>2</sup>C-Compatible Serial Interface Characteristics

VDD\_VCO, VDDO\_12, VDDO\_34, VDD\_REF = 1.8 V ± 5%, 2.5 V ± 5%, 3.3 V ± 5% and T<sub>A</sub> = -40°C to 105°C

PARAMETER		TEST CONDITIONS	MIN	TYP	MAX	UNIT
V <sub>IH</sub>	Input Voltage, Logic High		0.7 × VDD_REF			V
V <sub>IL</sub>	Input Voltage, Logic Low			0.3 × VDD_REF		V
I <sub>IH</sub>	Input Leakage Current	VDD_REF ± 10%	-5		5	μA
V <sub>OL</sub>	Low Level Output Voltage	at 3 mA sink current			0.4	V
C <sub>IN</sub>	Input Capacitance				10	pF
C <sub>OUT</sub>	Output Capacitance	max bus capacitance per pin			400	pF

## 7.23 Timing Requirements, I<sup>2</sup>C-Compatible Serial Interface

VDD\_VCO, VDDO\_12, VDDO\_34, VDD\_REF = 1.8 V ± 5%, 2.5 V ± 5%, 3.3 V ± 5% and T<sub>A</sub> = -40°C to 105°C

PARAMETER		TEST CONDITIONS	MIN	TYP	MAX	UNIT
t <sub>PW_G</sub>	Pulse Width of Suppressed Glitches				50	ns
f <sub>SCL</sub>	SCL Clock Frequency	Standard		100		kHz
f <sub>SCL</sub>	SCL Clock Frequency	Fast-mode		400		kHz
t <sub>SU_STA</sub>	Setup Time Start Condition	SCL=V <sub>IH</sub> before SDA=V <sub>IL</sub>		0.6		μs
t <sub>H_STA</sub>	Hold Time Start Condition	SCL=V <sub>IL</sub> after SCL=V <sub>IL</sub> . After this time, the first clock edge is generated.		0.6		μs
t <sub>SU_SDA</sub>	Setup Time Data	SDA valid after SCL=V <sub>IL</sub> , f <sub>SCL</sub> =100 kHz	250			ns
t <sub>SU_SDA</sub>	Setup Time Data	SDA valid after SCL=V <sub>IL</sub> , f <sub>SCL</sub> =400 kHz	100			ns
t <sub>H_SDA</sub>	Hold Time Data <sup>(1)</sup>	SDA valid before SCL=V <sub>IH</sub>	0 <sup>(2)</sup>		<sup>(3)</sup>	μs
t <sub>VD_SDA</sub>	Valid Data or Acknowledge Time	f <sub>SCL</sub> =100 kHz <sup>(3)</sup>			3.45	μs
t <sub>VD_SDA</sub>	Valid Data or Acknowledge Time	f <sub>SCL</sub> =400 kHz <sup>(2)</sup>			0.9	μs
t <sub>PWH_SCL</sub>	Pulse Width High, SCL	f <sub>SCL</sub> =100 kHz	4.0			μs
t <sub>PWH_SCL</sub>	Pulse Width High, SCL	f <sub>SCL</sub> =400 kHz	0.6			μs
t <sub>PWL_SCL</sub>	Pulse Width Low, SCL	f <sub>SCL</sub> =100 kHz	4.7			μs
t <sub>PWL_SCL</sub>	Pulse Width Low, SCL	f <sub>SCL</sub> =400 kHz	1.3			μs
t <sub>IR</sub>	Input Rise Time				300	ns
t <sub>IF</sub>	Input Fall Time				300	ns
t <sub>OF</sub>	Output Fall Time	10 pF ≤ C <sub>OUT</sub> ≤ 400 pF			250	ns
t <sub>SU_STOP</sub>	Setup Time Stop Condition			0.6		μs
t <sub>BUS</sub>	Bus-Free Time	Time between a Stop and a Start condition		1.3		μs

- (1) t<sub>H\_SDA</sub> is the data hold time that is measured from the falling edge of SCL, applies to data in transmission and the acknowledge.
- (2) A device must internally provide a hold time of at least 300 ns for the SDA signal (with respect to the V<sub>IH(min)</sub> of the SCL signal) to bridge the undefined region of the falling edge of SCL.
- (3) The maximum t<sub>H\_SDA</sub> could be 3.45 μs and 0.9 μs for Standard-mode and Fast-mode, but must be less than the maximum of t<sub>VD\_SDA</sub> by a transition time. This maximum must only be met if the device does not stretch the LOW period (t<sub>PWL\_SCL</sub>) of the SCL signal. If the clock stretches the SCL, the data must be valid by the setup time before it releases the clock.

## 7.24 Power Supply Characteristics

VDD\_VCO, VDDO\_12, VDDO\_34, VDD\_REF = 1.8 V ± 5%, 2.5 V ± 5%, 3.3 V ± 5% and T<sub>A</sub> = -40°C to 105°C

PARAMETER		TEST CONDITIONS	MIN	TYP	MAX	UNIT
I <sub>DD_REF</sub>	VDD_REF supply current	25 MHz XTAL, DBL ON		8		mA
I <sub>DD_VCO</sub>	VCO and PLL current	f <sub>VCO</sub> =2400 MHz, PSA = PSB = 4 and N-divider = 48		14		mA
I <sub>DD_OUT</sub>	Output Channel Current	IOD=6, LP-HCSL, 100MHz on OUT3 and OUT4, 25MHz on OUT0		22		mA
I <sub>DD_OUT</sub>	Output Channel Current	IOD = 6, LP-HCSL, 100 MHz on OUT1 and OUT2		17.5		mA
I <sub>DD_PDN</sub>	Power down current	using reset pin / bits		2.8	5	mA

VDD\_VCO, VDDO\_12, VDDO\_34, VDD\_REF = 1.8 V ± 5%, 2.5 V ± 5%, 3.3 V ± 5% and T<sub>A</sub> = -40°C to 105°C

PARAMETER		TEST CONDITIONS	MIN	TYP	MAX	UNIT
I <sub>DD_TYP</sub>	Typical current	4 x 100 MHz LVDS case using crystal input and doubler, SSC off		50	70	mA
I <sub>DD_TYP</sub>	Typical current	4 x 100 MHz LP-HCSL case using crystal input and doubler, SSC off		65	90	mA
L <sub>PSNR</sub>	Power supply noise rejection	OUTx = 100 MHz differential, on one of VDDx injected sine wave at f <sub>INJ</sub> = 100 kHz		-61		dB
L <sub>PSNR</sub>	Power supply noise rejection	OUTx = 100 MHz differential, on one of VDDx injected sine wave at f <sub>INJ</sub> = 1 MHz		-57		dB

## 7.25 Typical Characteristics

### Measured at room temperature

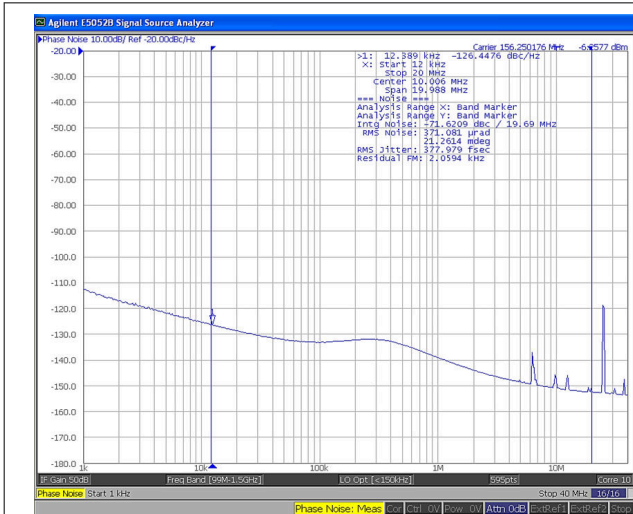

Reference: Crystal Closed-Loop Phase 156.25-MHz LVDS  
Input 25 MHz Noise from 2.5-GHz  
VCO

图 7-1. 156.25-MHz LVDS Output

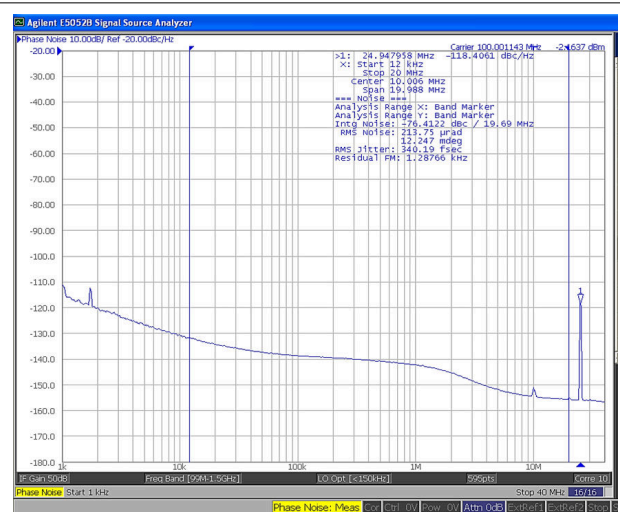

Reference: Crystal Closed-Loop Phase 100-MHz LP-HCSL  
Input 25 MHz Noise from 2.4-GHz  
VCO

图 7-2. 100-MHz LP-HCSL Output

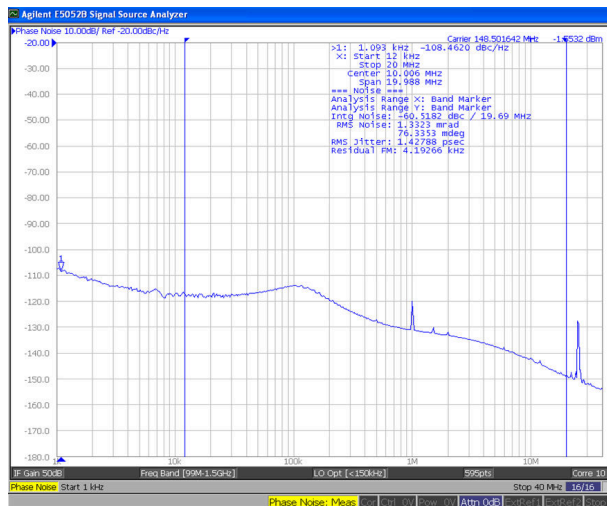

Reference: Crystal Closed-Loop Phase 148.5-MHz LVDS  
Input 25 MHz Noise from 2.376-GHz VCO

图 7-3. 148.5-MHz LVDS Output

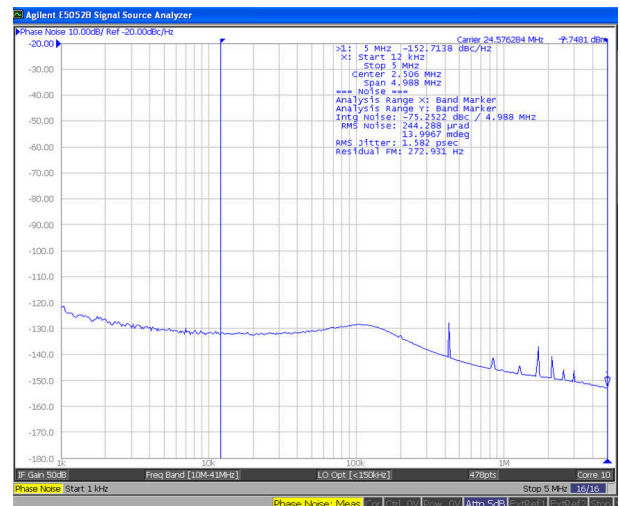

Reference: Crystal Closed-Loop Phase 24.576-MHz  
Input 25 MHz Noise from 2.4576-GHz VCO

图 7-4. 24.576-MHz LVCMOS Output



图 7-5. All Power Supply = 1.8 V, VDD Ramp Time = 1 ms



图 7-6. All Power Supply = 3.3 V, VDD Ramp Time = 1 ms

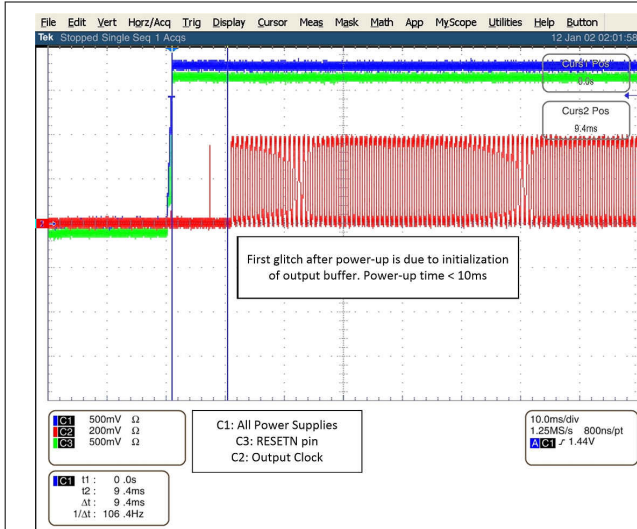

图 7-7. All Power Supply = 1.8 V, VDD Ramp Time = 10 ms

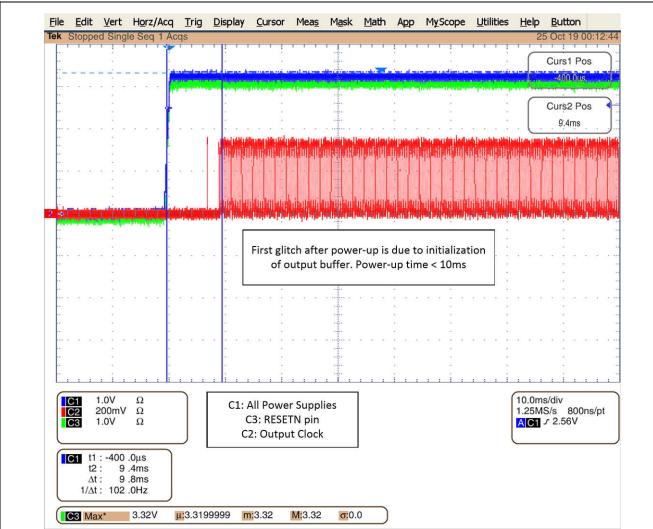

图 7-8. All Power Supply = 3.3 V, VDD Ramp Time = 10 ms

## 8 Parameter Measurement Information

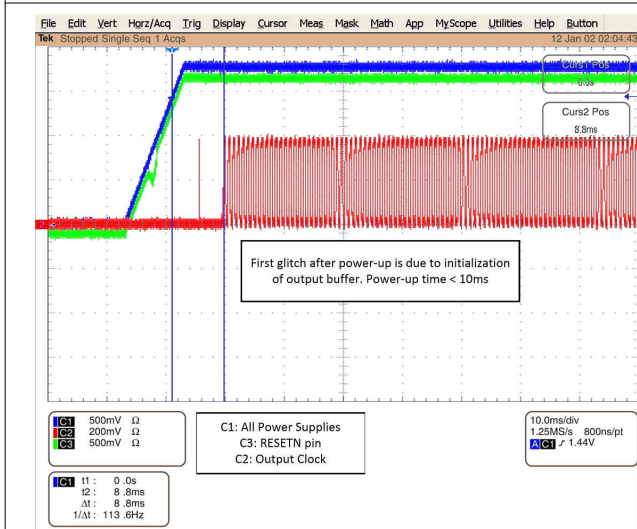
### 8.1 Reference Inputs

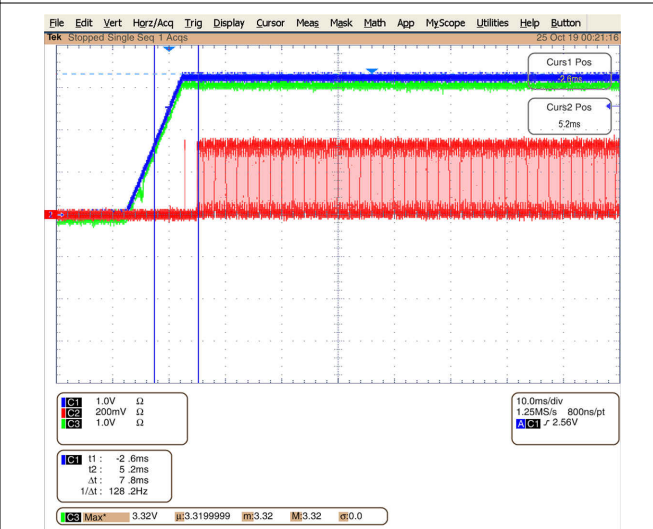

图 8-1. Differential AC-Coupled Input

### 8.2 Outputs



图 8-2. LVC MOS Output Test Configuration

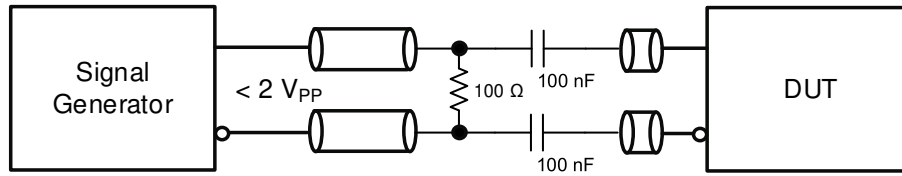

图 8-3. LVDS Output Test Configuration, AC-Coupled

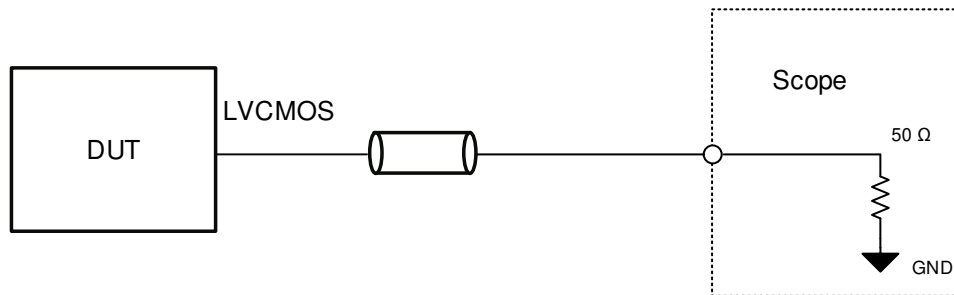

图 8-4. LP-HCSL Test Configuration, DC-Coupled

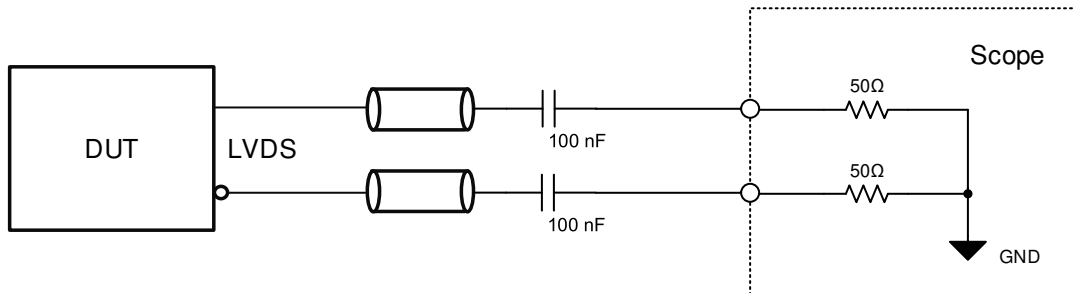

图 8-5. LVDS Common Mode Voltage, DC-Coupled

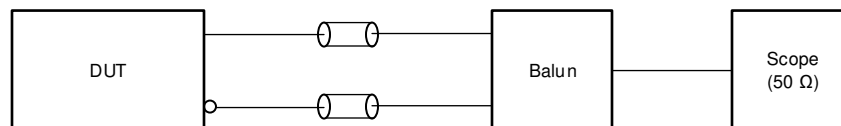

图 8-6. Differential Output Voltage and Rise/Fall Time

### 8.3 Serial Interface

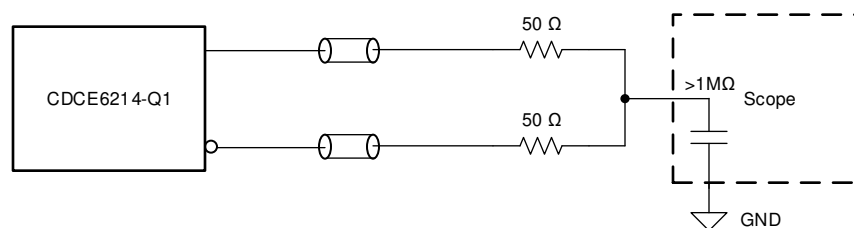

图 8-7. I<sup>2</sup>C Timing

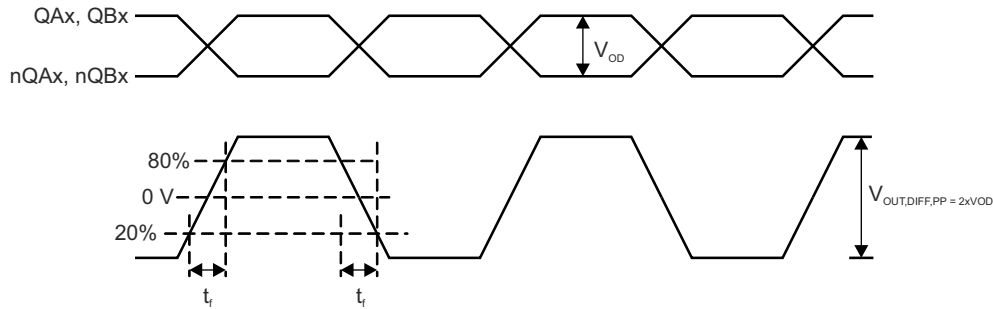
### 8.4 PSNR Test

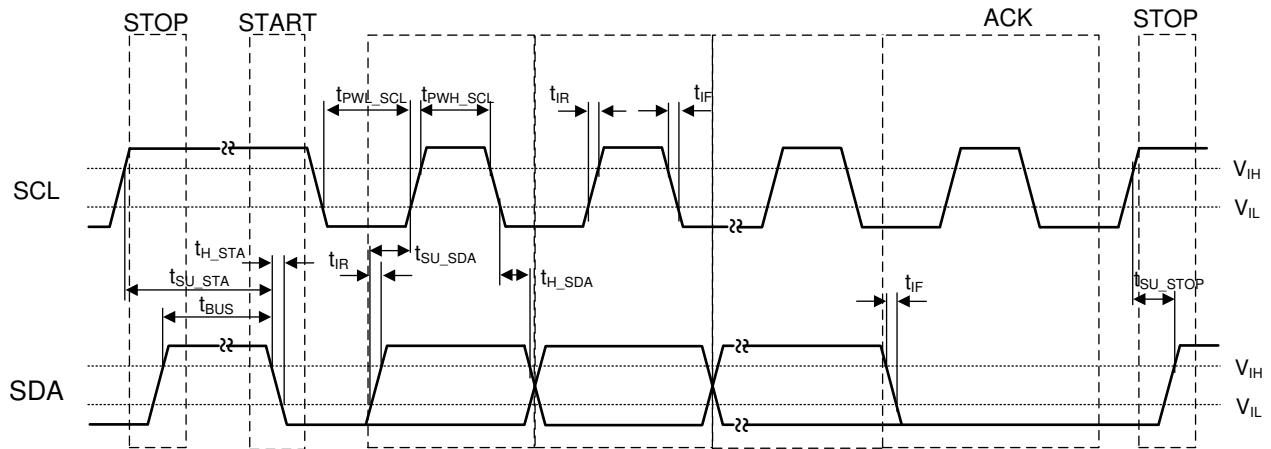

图 8-8. PSNR Test Configuration

### 8.5 Clock Interfacing and Termination

#### 8.5.1 Reference Input

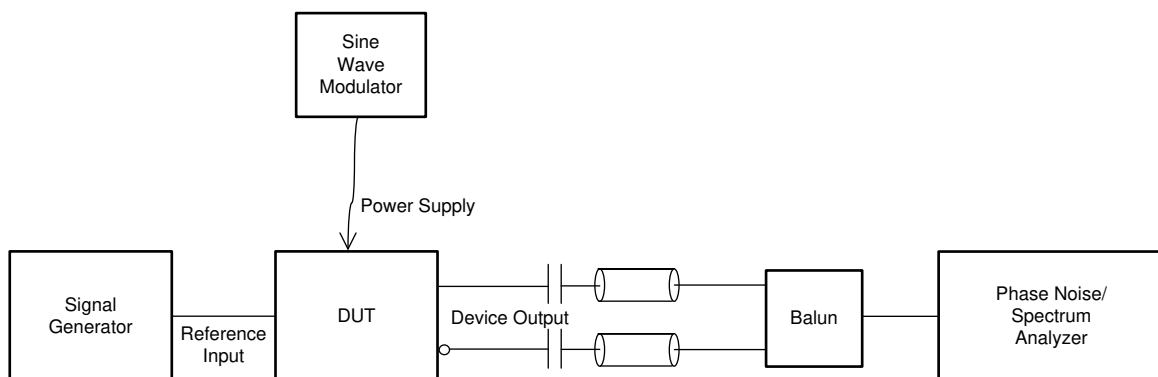

图 8-9. Single-Ended LVCMOS to Reference



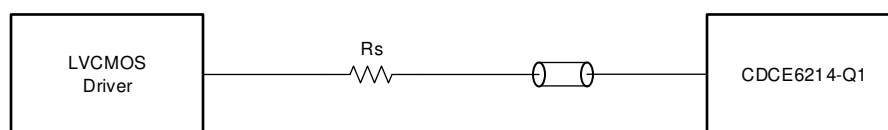

图 8-10. Differential Input to Reference

### 8.5.2 Outputs



图 8-11. LVCMOS Output

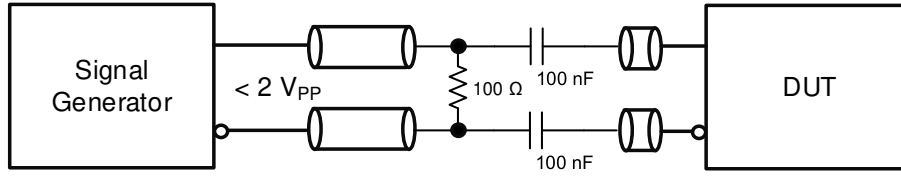

图 8-12. LVDS Output - DC-Coupled. Place  $100 \Omega$  close to the DUT

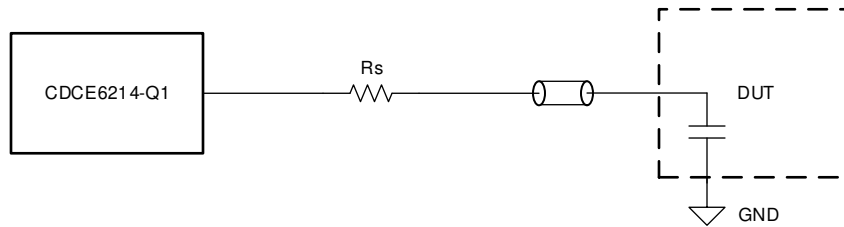

图 8-13. LVDS Output - AC-Coupled

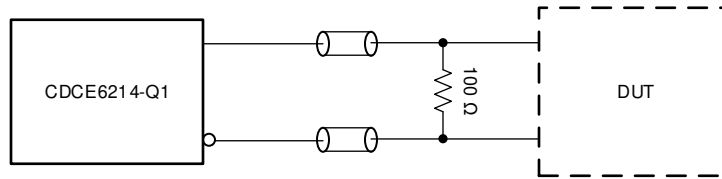

图 8-14. LP-HCSL Output

## 9 Detailed Description

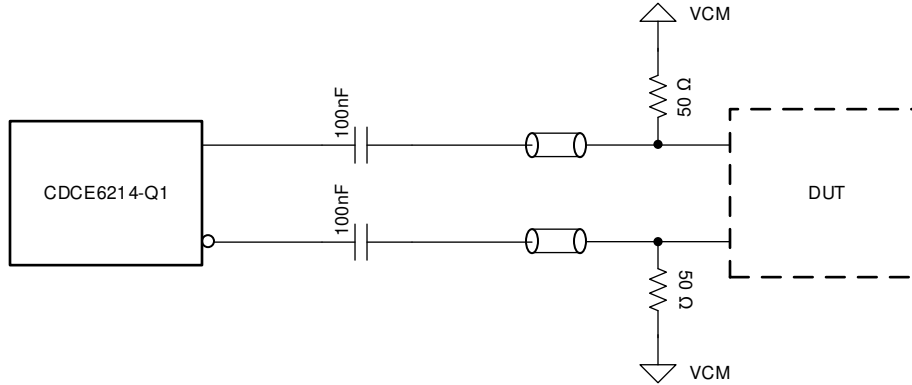
### 9.1 Overview

The CDCE6214-Q1 automotive clock generator is a Phase-Locked Loop (PLL) with integrated voltage controlled Oscillator (VCO) and integrated loop filter with selectable input reference. Input reference supports XTAL, Differential and single-ended LVCMOS inputs. The PLL consists of Frac-N PLL with integrated VCO range of 2335MHz - 2625MHz. The output of the VCO is connected to the clock distribution network, which includes multiple frequency dividers and multiplexers. The output of these network is connected to four output channels with configurable differential and single ended buffers. There are 4 power supply pins which can be independently configured to 1.8V/2.5V/3.3V. CDCE6214-Q1 can be configured using the I<sup>2</sup>C serial interface or built-in EEPROM at power up. This device supports various modes such as Digitally Controlled Oscillator (DCO) through GPIO/I2C and Internal/external Zero Delay mode.

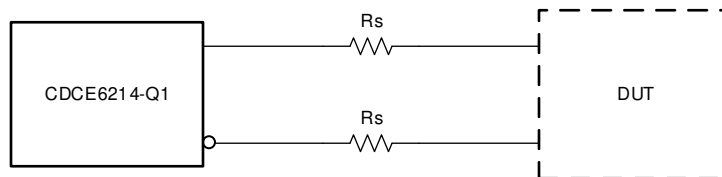
### 9.2 Functional Block Diagram



图 9-1. CDCE6214-Q1 Clock Generator With 2 Inputs, 1 Fractional-N PLL, and 4 Outputs

### 9.3 Feature Description

The following sections describe the individual blocks of the CDCE6214-Q1 ultra low power clock generator.

#### 9.3.1 Reference Block

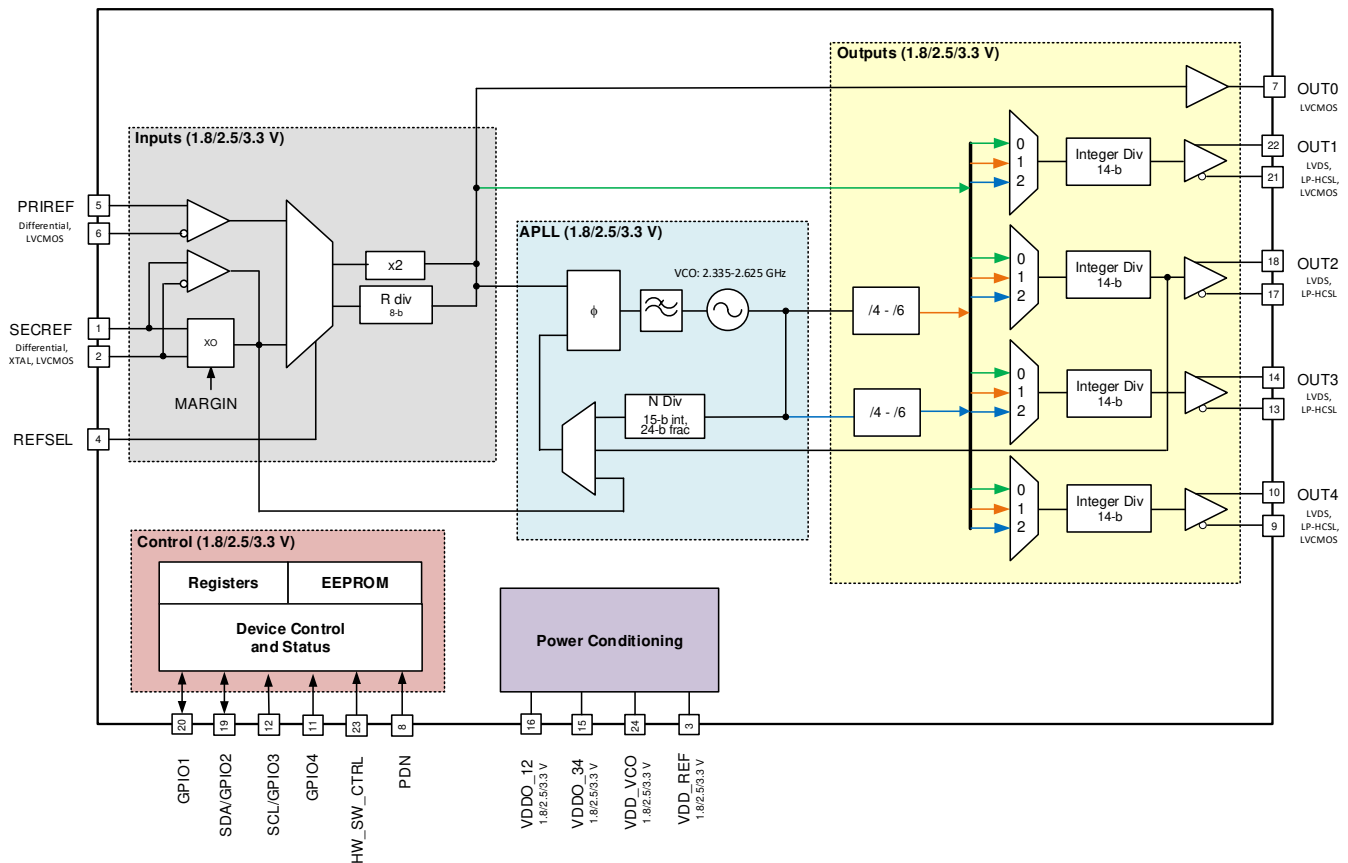
A reference clock to the PLL is fed to pins 1 (SECREF\_P) and 2 (SECREF\_N) or to pins 5 (PR1REF\_P) and 6 (PR1REF\_N). There are multiple input stages to accommodate various clock references. Pins 1 and 2 can be used to connect a XTAL across it or provide an external single-ended LVCMOS clock or a differential clock. These modes are selectable through register programming. When differential mode is selected, appropriated biasing is applied to the pin. In case of differential mode, external AC-coupling capacitor is needed. When XTAL or LVCMOS mode is selected, biasing circuitry is disengaged. Pins 5 and 6 can be used to provide an external single-ended LVCMOS clock or a differential clock.

The reference MUX selects the reference clock for the PLL. Setting REFSEL pin = L selects SECREF input, while setting REFSEL pin = H selects PRIREF Input. Alternatively, this can be configured through the register settings.

**表 9-1. Reference Input Selection**

REGISTER BIT ADDRESS	REGISTER BIT FIELD NAME	VALUE	DESCRIPTION
R2[1:0]	REFSEL_SW	0h or 1h	Input Reference Mux controlled through Pin 4 (REFSEL)
	(Default: 0h)	2h	Pin1/Pin 2 SECREF Input selected. This is independent of Pin 4 status.
		3h	Pin 5/Pin 6 PRIREF Input selected. This is independent of Pin 4 status.
R24[1:0]	IP_SECREF_BUF_SEL	0h	XO enabled. Valid for SECREF pins.
	(Default: 0h)	1h	LVC MOS Buffer enabled. Valid for SECREF pins.
		2h or 3h	Differential Buffer enabled. Valid for SECREF pins.
R24[15]	IP_PRIREF_BUF_SEL	0h	LVC MOS Buffer enabled. Valid for PRIREF pins.
	(Default: 0h)	1h	Differential Buffer enabled. Valid for PRIREF pins.

A reference divider or a clock-doubler can be engaged to further multiply (2x) or divide the reference clock to the PLL. IP\_RDIV[7:0] can be used to set the value of the divider. Setting this to 00h would enable the doubler.

The output clock from the reference block can be bypassed to the OUT0 and other output channels. The bypassed clock is selectable between the Input clock or PFD clock. More details available in [表 9-9](#).

The SECREF\_P and SECREF\_N pins provide a crystal oscillator stage to drive a fundamental mode crystal in the range of 10 MHz to 50 MHz. The crystal input stage integrates a tunable load capacitor array up to 9 pF and programmable through R24[12:8]. The drive capability of the oscillator is programmable through R24[5:2].

The LVC MOS input buffer threshold voltage follows VDD\_REF. This device can be used as a level shifter because the outputs have separate supplies.

### 9.3.1.1 Zero Delay Mode, Internal and External Path

The CDCE6214-Q1 can operate in Zero Delay Mode with internal as well as external feedback. In Zero Delay Mode, PRIREF clock is used as the reference clock to the PFD. SECREF input clock can be used to feed an external source as feedback clock to the PFD. External feedback path is recommended for zero delay operation. Moreover there is an additional internal feedback path which is sourced from output channel 2. It is expected that the Input-output propagation delay would be higher in Internal zero-delay mode than external zero delay mode.

**表 9-2. Zero Delay Operation <sup>1 2 3</sup>**

OPERATION	REFSEL	R2[1:0] - REFSEL_SW	R24[1:0] - IP_SECREF_BUF_SEL	R24[15] - IP_PRIREF_BUF_SEL	R0[8] - ZDM_EN	R0[10] - ZDM_CLOCKSEL	DESCRIPTION
Normal Operation, XTAL Input	L	0h or 1h or 2h	0h	X	0h	0h	Normal Operation, XTAL Input

<sup>1</sup> In zero delay mode, all dividers should be programmed such that PLL can lock. On power-up in zero-delay mode, PLL would lock automatically

<sup>2</sup> For internal Zero delay mode, channel 2 is required. Channel 2 should not be powered down

<sup>3</sup> "X" allows any possible bit-field value. It has no impact on the functionality

表 9-2. Zero Delay Operation <sup>1 2 3</sup> (continued)

OPERATION	REFSEL	R2[1:0] - REFSEL_SW	R24[1:0] - IP_SECREF_BUF_SEL	R24[15] - IP_PRIREF_BUF_SEL	R0[8] - ZDM_EN	R0[10] - ZDM_CLOCKSEL	DESCRIPTION
Normal Operation, Differential Input	L	0h or 1h or 2h	2h or 3h	X	0h	0h	SECREF/ Differential Input
Normal Operation, Differential Input	H	0h or 1h or 3h	X	1h	0h	0h	PRIREF/ Differential Input
Normal Operation, LVCMOS Input	L	0h or 1h or 2h	1h	X	0h	0h	SECREF/ LVCMOS Input
Normal Operation, LVCMOS Input	H	0h or 1h or 3h	X	0h	0h	0h	PRIREF/ LVCMOS Input
External Zero Delay Mode, Differential Input	H	0h or 1h or 3h	2h or 3h	1h	1h	1h	Input Clock on PRIREF, Feedback clock on SECREF
External Zero Delay Mode, LVCMOS Input	H	0h or 1h or 3h	1h	0h	1h	1h	Input Clock on PRIREF, Feedback clock on SECREF
Internal Zero Delay Mode, Differential Input	H	0h or 1h or 3h	X	1h	1h	0h	Input clock on PRIREF
Internal Zero Delay Mode, Differential Input	H	0h or 1h or 3h	X	0h	1h	0h	Input clock in PRIREF



图 9-2. Input/Output Alignment in External Zero Delay Mode for LVCMOS Output

- <sup>1</sup> In zero delay mode, all dividers should be programmed such that PLL can lock. On power-up in zero-delay mode, PLL would lock automatically
- <sup>2</sup> For internal Zero delay mode, channel 2 is required. Channel 2 should not be powered down
- <sup>3</sup> "X" allows any possible bit-field value. It has no impact on the functionality

### 9.3.2 Phase-Locked Loop (PLL)

The CDCE6214-Q1 has a fully-integrated Phase-Locked Loop (PLL) circuit. The error between a reference phase and an internal feedback phase is compared at the phase-frequency-detector. The comparison result is fed to a charge pump that is connected to an integrated loop filter. The control voltage resulting from the loop filter tunes an internal Voltage-Controlled Oscillator (VCO). The frequency of the VCO is fed through a feedback divider (N-counter) back to the PFD.

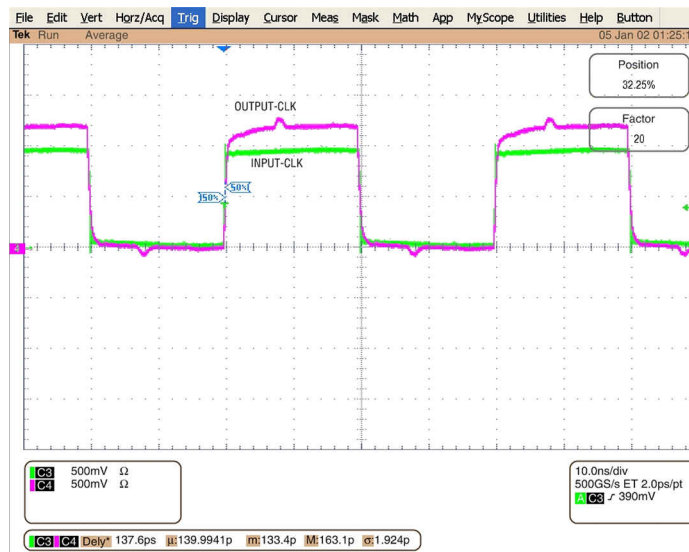
- Integer and Fractional-N PLL mode of operation.
- First-, Second-, or Third-Order MASH operation in Fractional mode.
- 24-bit Numerator and Denominator can be used to generate fractional frequencies with 0 ppb frequency accuracy.
- PFD operates between 1 MHz and 100 MHz.
- Live Lock Detector (R7[0] or PLL\_LOCK in GPIO) provides PLL Lock status (in fractional mode and SSC enabled, lock detect window need to be widened. R50[10:8] = 7h). Additionally, sticky bit lock detect (R7[1]) detects if there was any temporary loss of lock.
- Integrated selectable loop filter components.
- For a 25-MHz PFD frequency, PFD bandwidth between 100 kHz and 1.6 MHz can be achieved to optimize PLL to input reference.
- Voltage-controlled oscillator (VCO) ranges from 2335 MHz to 2615 MHz.
- Supports 0.25% and 0.5% center and down spread Spread Spectrum Clocking (SSC) generation. Further, VCO also supports up to 0.5% SSC references at 100 MHz for PCIe clocking.

**表 9-3. Common Clock Generator Loop Filter Settings**

f <sub>VCO</sub> IN MHz	f <sub>PFD</sub> IN MHz	BW IN MHz	PHASE MARGIN IN °	DAMPING FACTOR	I <sub>CP</sub> IN mA	C <sub>Pcap</sub> IN pF	R <sub>Res</sub> IN kΩ	C <sub>Zcap</sub> IN pF
2400	25	0.469	70	0.5	0.60	16.1	2.5	580
2400	50	0.938	70	2	0.60	8.2	2.5	276
2400	100	1.60	70	0.5	0.80	8.2	2.5	303
2457.6	61.44	1.04	70	1.15	0.60	9.2	2.0	331
2500	25	0.49	70	0.4	0.60	13.5	2.5	497
2500	50	0.93	70	1.0	0.60	11.7	2.5	386
2400	50	400	65	0.1	0.40	11.7	1.5	636

**表 9-4. Common PLL Divider Settings <sup>4</sup>**

INPUT FREQUENCY IN MHz	f <sub>PFD</sub> IN MHz	OUTPUT FREQUENCY IN MHz	f <sub>VCO</sub>	N-COUNTER DIVIDER VALUE	NUMERATOR	DENOMINATOR	PSA	OUTPUT DIVIDER
25	50	100	2400	48	NA	NA	4	6
25	25	100	2400	96	NA	NA	4	6
25	50	156.25	2500	50	NA	NA	4	4
25	25	25	2400	96	NA	NA	4	24
25	25	24.576	2457.6	98	5071614	16682942	4	25
25	25	148.5	2376	95	664983	16624579	4	4

#### 9.3.2.1 PLL Configuration and Divider Settings

$$f_{PFD} = F_{in} / F_{factor}$$

F<sub>factor</sub> is determined by R25[7:0] - ip\_ref\_div. F<sub>factor</sub> = 0.5 when ip\_ref\_div=0, F<sub>factor</sub> = ip\_ref\_div, otherwise.

$$f_{VCO} = f_{PFD} \times (N + Num/Den).$$

N is set by R30[14:0] - PLL\_NDIV. Num is the numerator of the fraction, set by {R32[7:0],R31[15:0]}. Den is the denominator of the fraction, set by R34[7:0],R33[15:0]. When {R34[7:0],R33[15:0]} = 0, Den=2<sup>24</sup>.

<sup>4</sup> Fractional Mode settings are based on DCO mode step size of 0.1ppm

The sigma delta modulator supports different order of MASH to shape the quantization noise. For Integer mode, R27[1:0] is set as 0h. For fractional mode, it can be set to 1h, 2h or 3h for first, second and third order, respectively.

In integer mode, PLL is configured in single-ended PFD configuration by setting R51[6]=1h. In Fractional mode, PLL should be configured in Differential PFD configuration by setting R51[6]=0h. Further, R51[10] is set as 1h in fractional mode and 0h in Integer mode.

### 9.3.2.2 Spread Spectrum Clocking

The energy of the harmonics from the rectangular clock signal can be spread over a certain frequency range. This frequency deviation leads to lowered average amplitude of the harmonics. This can help to mitigate electromagnetic interference (EMI) challenges in a system when the receiver supports this mode of operation. The modulation shape is triangular.

The SSC clock is generated through the fractional-N PLL. When SSC is enabled, SSC clock is available on all clock sourced from the PLL. Reference clock or PFD clock is available on the OUT1 - OUT4 pins.

Down spread and center spread are supported. The following modes are supported.

- PFD frequencies: Either 25 MHz or 50 MHz.
- Down spread: - 0.25% and  $\pm 0.5\%$
- Center spread:  $\pm 0.25\%$  and  $\pm 0.5\%$

Pre-configured settings are available to select any of these combinations.

Using these pre-configured settings, fmod of 31.5 kHz is synthesized for 100-MHz output clock.



图 9-3. Spread Spectrum Clock

表 9-5. Spread Spectrum Settings <sup>5 6</sup>

R41[15] - SSC_EN	R42[5] - SSC_TYPE	R42[3:1] - SSC_SEL	DESCRIPTION
0h	X	X	No SSC modulation at output
1h	0h	X	Down spread SSC modulation. SSC spread is determined by ssc_sel
1h	1h	X	Center spread SSC modulation. SSC spread is determined by ssc_sel
1h	X	0h	25-MHz PFD, +/- 0.25% for Center spread, -0.25% for Down spread.
1h	X	1h	25-MHz PFD, +/- 0.50% for Center spread, -0.50% for Down spread.
1h	X	2h	50-MHz PFD, +/- 0.25% for Center spread, -0.25% for Down spread.
1h	X	3h	50-MHz PFD, +/- 0.50% for Center spread, -0.50% for Down spread.
1h	X	4h-7h	Do not use

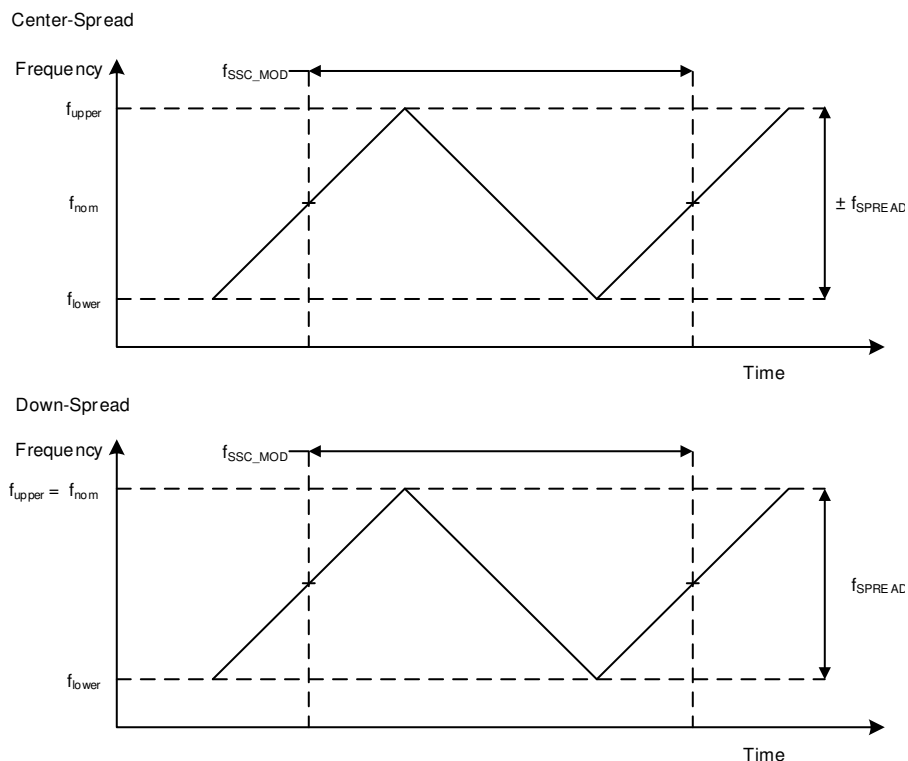

图 9-4. 100 MHz With - 0.25% Down Spread With and Without Trace



图 9-5. 100 MHz With +/- 0.25% Center Spread With and Without Trace

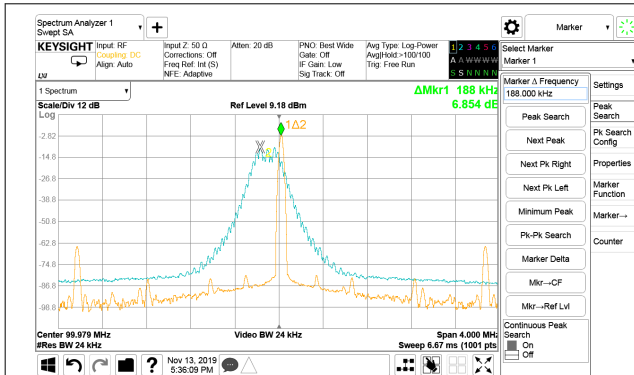

图 9-6. 100 MHz With - 0.5% Down Spread With and Without Trace

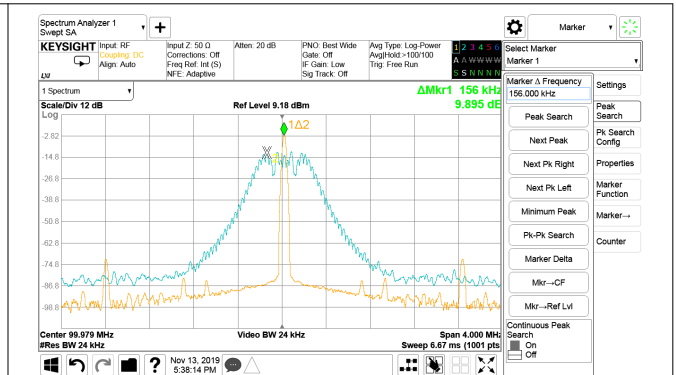

图 9-7. 100 MHz With +/- 0.5% Center Spread With and Without Trace

<sup>5</sup> X signifies that this bitfield can take any value

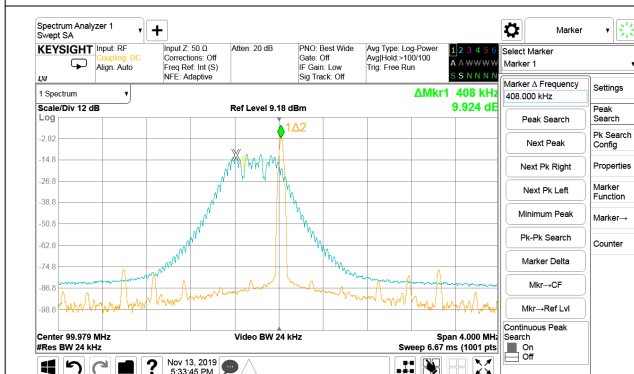
<sup>6</sup> For any other SSC spread and modulation rate, please contact TI representative.

表 9-6. PCI Express Compliance Measurement

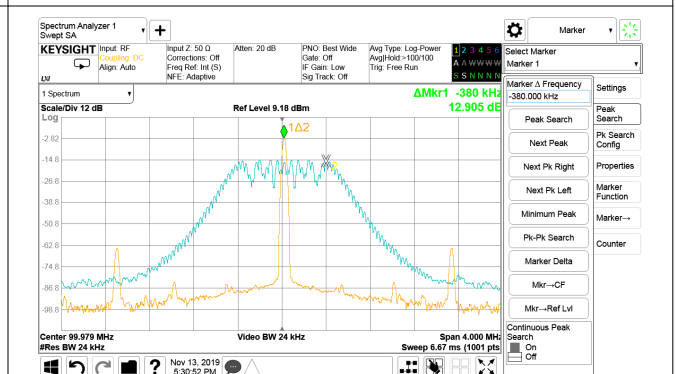
NO.	CLASS	DATA RATE	ARCHITECTURE	MEASURED PNA METHOD	MEASURED SCOPE METHOD	SPEC LIMIT	RESULT
1	Gen4	16 Gb/s	CC	195 fs	260 fs	500 fs	PASS
2	Gen4	16 Gb/s	SRIS	-	490 fs	500 fs	PASS
3	Gen5	32 Gb/s	CC	87 fs	111 fs	150 fs	PASS
4	Gen5	32 Gb/s	SRIS	-	157 fs	*	*

### 9.3.2.3 Digitally-Controlled Oscillator/ Frequency Increment and Decrement - Serial Interface Mode and GPIO Mode

In this mode, the output clock frequency can be incremented or decremented by a fixed frequency step. The frequency step size is determined by the register R43[15:0]. This value is added or subtracted to the numerator of the sigma-delta modulator. Various bit fields as shown in **BROKEN\_LINK** can be used to exercise this functionality. Every rising edge of **FREQ\_INC** signal increases the output frequency, while every rising edge of **FREQ\_DEC** signal decreases the output frequency. There are two ways to trigger the increment or decrement:

1. Appropriate configuration of the GPIOs and sending **FREQ\_INC/FREQ\_DEC** signal through an external microcontroller or ASIC.
2. Using register bit fields controlled through serial interface.

表 9-7. Register Settings for Frequency Increment/Decrement Functionality

REGISTER BIT ADDRESS	REGISTER BIT FIELD NAME	DESCRIPTION
R3[3]	FREQ_INC_DEC_EN	Enables/Disables DCO mode
R3[4]	FREQ_INC_DEC_REG_MODE	Selects DCO trigger through GPIOs or Serial Interface.
R3[6:5]	FREQ_DEC_REG, FREQ_INC_REG	Generates <b>FREQ_INC/FREQ_DEC</b> signal through serial Interface
R43[15:0]	FREQ_INC_DEC_DELTA	Frequency Increment/Decrement step size

表 9-8. Computing Divider Settings in DCO Mode

PARAMETERS	VALUE (EXAMPLE)	DESCRIPTION
Input PFD Frequency ( $F_{PFD}$ )	25 MHz	Set according to $F_{PFD}$ .
Expected VCO Frequency ( $F_{VCO}$ )	2457.6 MHz	$F_{VCO}$ is set within the operating VCO range of 2335 MHz - 2625 MHz. $F_{VCO}$ is selected such that $PSA/PSB/Output\ Divider$ is Integer.
Expected Output Frequency ( $F_{OUT}$ )	24.576 MHz	$PSA = 4$ , $IOD = 25$ . $F_{VCO} = PSA \times IOD \times F_{OUT}$ .
Expected step size (in ppm) ( $F_{step}$ )	0.1	Every rising edge of <b>FREQ_INC/FREQ_DEC</b> would change the output by this step size.
N-divider Value (N)	98	$INT(F_{VCO}/F_{PFD})$
Minimum Numerator value to meet 0ppb accuracy (Num)	76	These values are computed to meet accuracy requirement at output. Should be less than $2^{24}$ .
Minimum Denominator to meet 0ppb accuracy (Den)	250	
Minimum Denominator value to meet ppm step size ( $F_{DEN,min}$ )	101725.26	$1/(F_{step} \times 1e6) / (F_{VCO}/F_{PFD})$
Final Denominator value ( $F_{DEN,final}$ )	500000	$F_{DEN,final}$ should be greater than $F_{DEN,min}$ and less than $2^{24}$ . $F_{DEN,final}$ and $F_{NUM,final}$ should be integer multiple of Den and Num respectively. $F_{DEN,final}/Den = F_{NUM,final}/Num$
Final Numerator value ( $F_{NUM,final}$ )	152000	
Increment/ Decrement step size	5	This value should be less than $2^{16}-1$ . $F_{DEN,final}$ should be closest integer multiple of $F_{DEN,min}$ .



### 9.3.3 Clock Distribution

The VCO output connects to two individually configurable pre-scalar dividers sourcing the on-chip clock distribution - PSA and PSB. PSA and PSB can be configured as division value of /4, /5 or /6 independently.

The clock distribution consists of four output channels. Each output channel contains an integer divider (IOD) with glitchless switching and synchronization capabilities.

IOD can be sourced from either the PSA, the PSB, or the Reference Clock. IOD can be bypassed to provide a Reference clock at the output.

There are five output channels - OUT0, OUT1, OUT2, OUT3, and OUT4.

The OUT0 is a slew-rate controllable LVCMOS output. Either the reference clock or PFD clock can be routed to this output through the clock distribution network.

The OUT1 and OUT4 are identical output channels. The output buffers in this channel are compatible with various signaling standards - LVCMOS, LP-HCSL, and LVDS-like.

The OUT2 and OUT3 are identical output channels. The output buffers in this channel are compatible with various signaling standards - LP-HCSL and LVDS-like.

- The LP-HCSL output buffer can be directly connected to the receiver without any termination resistor to GND. The output impedance of LP-HCSL is trimmed to 50 Ω ± 10%. A series resistor can be used to adapt to the trace impedance.
- The LVDS-like requires a differential termination connected between the positive and negative polarity output pins. The termination can be connected directly or through an AC-coupling capacitor. For a 50-Ω system, a 100-Ω differential termination is appropriate.
- LVCMOS outputs are designed for capacitive loads only. The polarity of the positive and negative output pins can be configured individually.

The differential buffers support wide range of output frequencies up to 328.125 MHz. LVCMOS supports up to 200 MHz.

**表 9-9. Configuring Input Reference/PFD/PLL Clock to Output <sup>7</sup>**

REGISTER BIT ADDRESS	REGISTER BIT FIELD NAME	DESCRIPTION
R25[10]	IP_BYP_OUT0_EN	Enables Reference Clock/PFD Clock to OUT0.
R25[9]	REF_CH_MUX	Selects between PFD Clock or Input Reference Clock
R25[14:11]	IP_REF_TO_OUT4_EN, IP_REF_TO_OUT3_EN, IP_REF_TO_OUT2_EN, IP_REF_TO_OUT1_EN	Selects reference clock to OUT1-OUT4
R56[15:14]	CH1_MUX	Clock selection MUX control for OUT1
R62[15:14]	CH2_MUX	Clock selection MUX control for OUT2
R67[15:14]	CH3_MUX	Clock selection MUX control for OUT3
R72[15:14]	CH4_MUX	Clock selection MUX control for OUT4

**表 9-10. Configuring Clock Distribution Network**

REGISTER BIT ADDRESS	REGISTER BIT FIELD NAME	DESCRIPTION
R47[6:5]	PLL_PSB	Programmable Pre-scalar divider PSB
R47[4:3]	PLL_PSA	Programmable Pre-scalar divider PSA
R56[13:0]	CH1_DIV	OUT1 Integer Divider value
R62[13:0]	CH2_DIV	OUT2 Integer Divider value
R67[13:0]	CH3_DIV	OUT3 Integer Divider value

<sup>7</sup> It is recommended to disable any clock when not in use to reduce crosstalk

表 9-10. Configuring Clock Distribution Network (continued)

REGISTER BIT ADDRESS	REGISTER BIT FIELD NAME	DESCRIPTION
R72[13:0]	CH4_DIV	OUT4 Integer Divider value

表 9-11. Configuring LVCMOS Output Buffer <sup>8 9</sup>

REGISTER BIT ADDRESS	REGISTER BIT FIELD NAME	DESCRIPTION
R78[12]	CH0_EN	Enables OUT0 LVCMOS Buffer
R79[3:0]	CH0_CMOS_SLEW_RATE_CTRL	Controls output slew rate of OUT0 LVCMOS Buffer
R59[14], R75[14]	CH1_CMOSN_EN, CH4_CMOSP_EN	Enables OUT1N/OUT4P LVCMOS Buffer
R59[13], R75[13]	CH1_CMOSP_EN, CH4_CMOSN_EN	Enables OUT1P/OUT4N LVCMOS Buffer
R59[12], R75[12]	CH1_CMOSN_POL, CH4_CMOSP_POL	Sets output polarity of OUT1N/OUT4P LVCMOS Buffer
R59[11], R75[11]	CH1_CMOSP_POL, CH4_CMOSN_POL	Sets output polarity of OUT1P/OUT4N LVCMOS Buffer
R60[3:0], R76[3:0]	CH1_CMOS_SLEW_RATE_CTRL, CH4_CMOS_SLEW_RATE_CTRL	Controls output slew rate of OUT1/OUT4 LVCMOS Buffer

表 9-12. Configuring LP-HCSL Output Buffer <sup>10 11 12</sup>

REGISTER BIT ADDRESS	REGISTER BIT FIELD NAME	DESCRIPTION
R57[14], R63[13], R68[13], R73[13]	CH1_HCSL_EN, CH2_HCSL_EN, CH3_HCSL_EN, CH4_HCSL_EN	Enables LP-HCSL buffer on OUT1/OUT2/OUT3/OUT4

表 9-13. Configuring LVDS-Like Output Buffer <sup>13 14 15</sup>

REGISTER BIT ADDRESS	REGISTER BIT FIELD NAME	DESCRIPTION
R59[15], R65[11], R70[11], R75[15]	CH1_LVDS_EN, CH2_LVDS_EN, CH3_LVDS_EN, CH4_LVDS_EN	Enables LVDS-like buffer on OUT1/OUT2/OUT3/OUT4
R60[15:12], R66[3:0], R71[3:0], R76[9:6]	CH1_DIFFBUF_IBIAS_TRIM, CH2_DIFFBUF_IBIAS_TRIM, CH3_DIFFBUF_IBIAS_TRIM, CH4_DIFFBUF_IBIAS_TRIM	Sets the output swing and output common mode of OUT1/OUT2/OUT3/OUT4
R60[11:10], R66[5:4], R71[5:4], R76[5:4]	CH1_LVDS_CMTRIM_INC, CH2_LVDS_CMTRIM_INC, CH3_LVDS_CMTRIM_INC, CH4_LVDS_CMTRIM_INC	Increases the output common mode of OUT1/OUT2/OUT3/OUT4. 2.5 V/3.3 V mode only.
R60[5:4], R65[14:13], R71[10:9], R77[1:0]	CH1_LVDS_CMTRIM_DEC, CH2_LVDS_CMTRIM_DEC, CH3_LVDS_CMTRIM_DEC, CH4_LVDS_CMTRIM_DEC	Decreases the output common mode of OUT1/OUT2/OUT3/OUT4. 2.5 V/3.3 V mode only.

### 9.3.3.1 Glitchless Operation

The bit fields `ch{x}_glitchless_en` can be used to enable glitchless output divider update. This feature ensures that the high pulse of a clock period is not cut off by the output divider update process. It also ensures that setup

<sup>8</sup> Multiple output buffers should not be enabled at the same time

<sup>9</sup> Based on the VDDO levels, `ch1_1p8vdet`, `ch2_1p8vdet`, `ch3_1p8vdet`, `ch4_1p8vdet` should be set accordingly. When setting for 1.8V, `safety_1p8v_mode` should be set.

<sup>10</sup> Multiple output buffers should not be enabled at the same time

<sup>11</sup> External termination not needed. Voltage mode driver.

<sup>12</sup> Based on the VDDO levels, `ch1_1p8vdet`, `ch2_1p8vdet`, `ch3_1p8vdet`, `ch4_1p8vdet` should be set accordingly. When setting for 1.8V, `safety_1p8v_mode` should be set.

<sup>13</sup> Multiple output buffers should not be enabled at the same time.

<sup>14</sup> 100 Ω differential termination needed in DC-coupled mode. 50 Ω single ended or 100 Ω differential termination needed in AC-coupled mode

<sup>15</sup> Based on the VDDO levels, `ch1_1p8vdet`, `ch2_1p8vdet`, `ch3_1p8vdet`, `ch4_1p8vdet` should be set accordingly. When setting for 1.8V, `safety_1p8v_mode` should be set.

and hold time of a receiver is not violated. The low pulse in the transition from earlier period to the new period is extended accordingly.

Glitch-Less Divider Disabled:

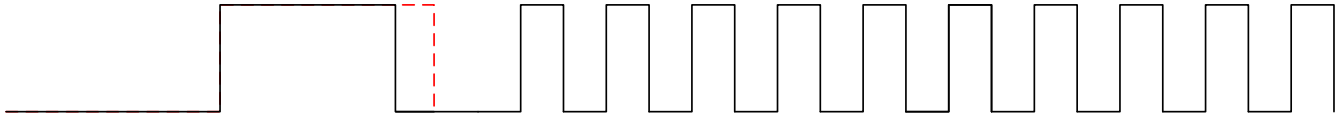

Glitch-Less Divider Enabled:



图 9-8. Glitchless Divider Update

### 9.3.3.2 Divider Synchronization

The output dividers can be reset in a deterministic way. This can be achieved using the sync bit or PDN pin. The level of the pin is qualified internally using the reference frequency at the PFD input. A low level on the SYNCN pin or sync bit will mute the outputs. A high level will synchronously release all output dividers to operation, so that all outputs share a common rising edge. The first rising edge can be individually delayed in steps of the respective pre-scalar period, up to 32 cycles using `ch{x}_sync_delay`. This allows the user to compensate external delays like routing mismatch, cables, or inherent delays introduced by logic gates in an FPGA design. Each channel can be included or excluded from the SYNC process. Divider synchronization can be enabled individually by `ch{x}_sync_en`.

For a deterministic behavior over power-cycles seen from input to output the reference divider must be set to 1. It should not divide the reference clock nor should the reference doubler be used.

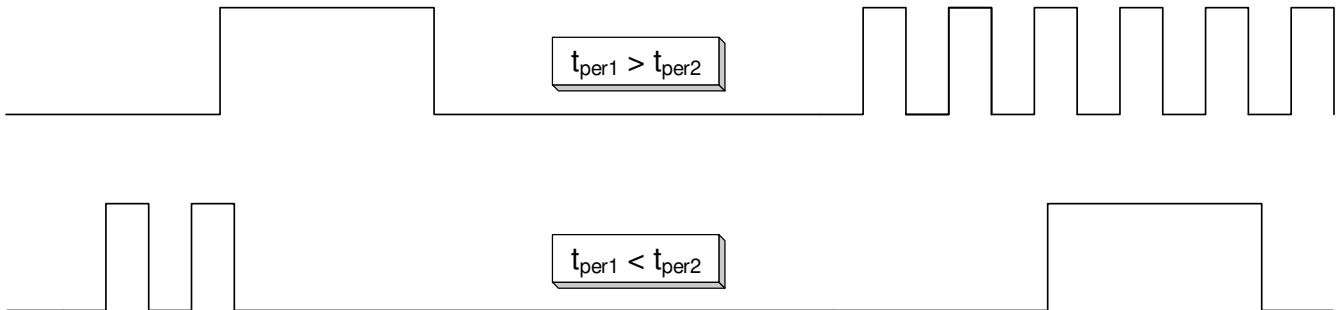

图 9-9. Output Divider Synchronization

### 9.3.3.3 Global and Individual Output Enable

The output enable functionality allows the user to enable or disable all or a specific output buffer. The bypass copy on OUT0 is excluded from the global output enable signal. When an output is disabled, it drives a configurable mute-state. When the serial interface is deactivated one can use all individual output enable signals at the same time. The individual output enable signal controls the respective output channel integer divider to gate the clock, therefore each integer divider must be active.

The individual output enable signal enables and disables the respective output in a deterministic way. Therefore the high and low level of the signal is qualified by counting four cycles of the respective output clock.

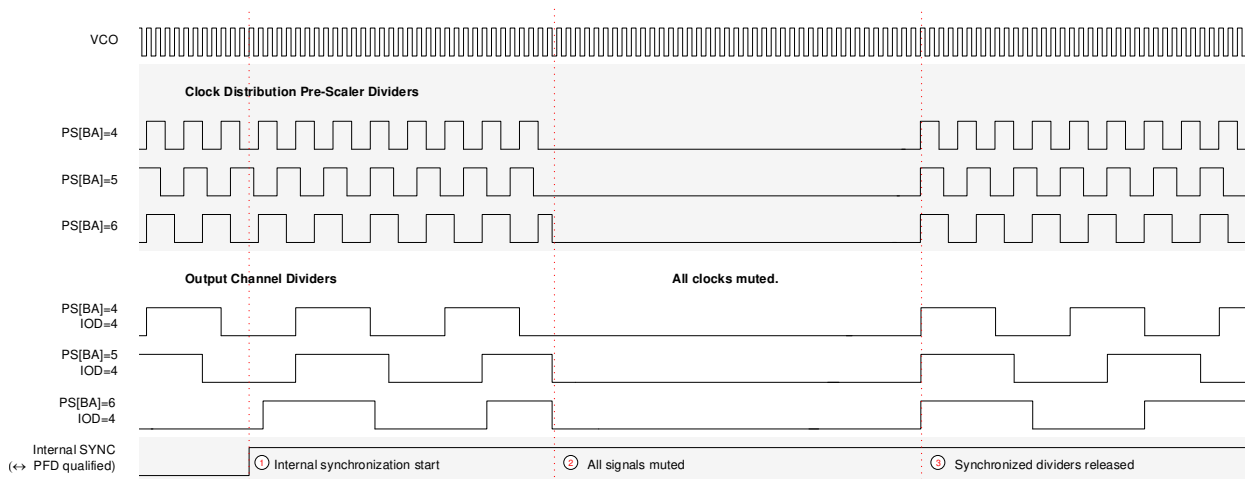
1. The OE falling edge disables the output. The output is enabled for 4 cycles after asserting the Output Enable of a channel. This will enable any further operation in the system after OE is asserted.
2. The OE rising edge enables the output. Outputs starts toggling after 4 internal clock cycles.

MUTE\_SEL= Logic Low

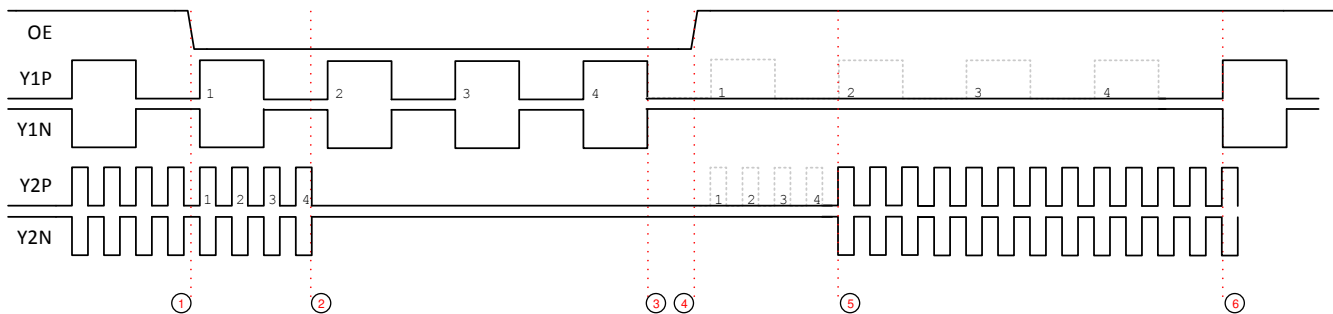

MUTE\_SEL= Logic High



图 9-10. Individual Output Enable and Disable

表 9-14. Glitch-less Operation, Divider Synchronization and Global/Individual OE Settings

REGISTER BIT ADDRESS	REGISTER BIT FIELD NAME	DESCRIPTION
R0[14]	PDN_INPUT_SEL	Configures PDN pin as PDN or SYNCN
R0[5]	SYNC	Generates SYNC signal through serial interface
R57[9], R63[9], R68[9], R73[9]	CH1_GLITCHLESS_EN, CH2_GLITCHLESS_EN, CH3_GLITCHLESS_EN, CH4_GLITCHLESS_EN	Enables Glitch-less switching for OUT1/ OUT2/OUT3/OUT4
R57[3], R63[3], R68[3], R73[3]	CH1_SYNC_EN, CH2_SYNC_EN, CH3_SYNC_EN, CH4_SYNC_EN	Enables SYNC for OUT1/OUT2/OUT3/OUT4
R57[1], R63[1], R68[1], R73[1]	CH1_MUTESEL, CH2_MUTESEL, CH3_MUTESEL, CH4_MUTESEL	Sets Output level when mute on OUT1/ OUT2/OUT3/OUT4
R57[0], R63[0], R68[0], R73[0]	CH1_MUTE, CH2_MUTE, CH3_MUTE, CH4_MUTE	Mutes output on OUT1/OUT2/OUT3/OUT4

### 9.3.4 Power Supplies and Power Management

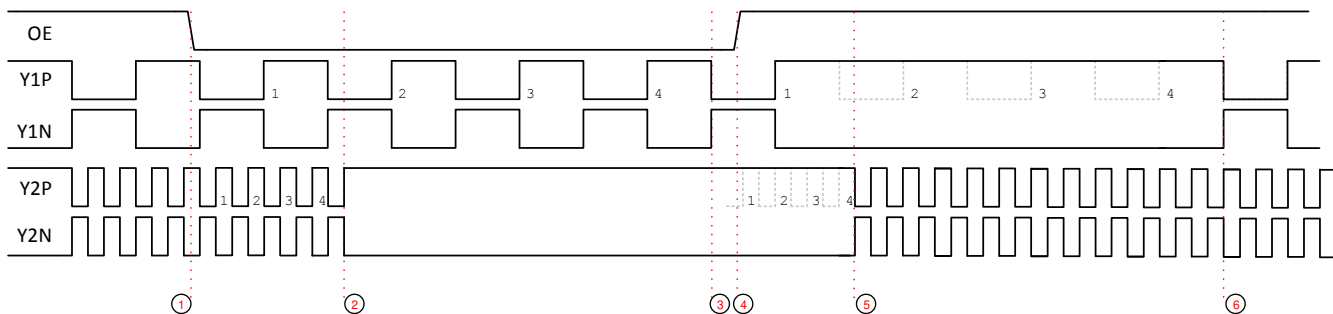
The CDCE6214-Q1 provides multiple power supply pins. Each of the power supplies supports 1.8 V, 2.5 V, or 3.3 V individually. Internal low-dropout regulators (LDO) source the internal blocks and allow each pin to be supplied with its individual supply voltage. The VDDREF pin supplies the control pins and the serial interface, therefore any pullup resistors shall be connected to the same domain as VDDREF.

The device is very flexible with respect to internal power management. Each block offers a power-down bit and can be disabled to save power when the block is not required. The available bits are illustrated in [表 9-15](#). The bypass output Y0 is connected to the pdn\_ch4 bit. Each output channel has a bit which should be adapted to the applied supply voltage, ch[4:1]\_1p8vdet.

**表 9-15. Power Management**

VDDREF	VDDVCO	VDDO_12	VDDO_34
R0[1] - POWERDOWN	R0[1] - POWERDOWN	R0[1] - POWERDOWN	R0[1] - POWERDOWN
	R5[8] - PLL_VCOBUFF_LDO_PD	R4[4] - CH1_PD	R4[6] - CH3_PD
	R5[7] - PLL_VCO_LDO_PD	R4[5] - CH2_PD	R4[7] - CH4_PD
	R5[6] - PLL_VCO_BUFF_PD		
	R5[5] - PLL_CP_LDO_PD		
	R5[4] - PLL_LOCKDET_PD		
	R5[3] - PLL_PSB_PD		
	R5[2] - PLL_PSA_PD		
	R5[1] - PLL_PFD_PD		
	R53[6] - PLL_NCTR_EN		
	R53[3] - PLL_CP_EN		

### 9.3.5 Control Pins

The ultra-low power clock generator is controlled by multiple LVCMOS input pins.

HW\_SW\_CTRL pin acts as EEPROM page select. The CDCE6214-Q1 clock generator contains two pages of configuration settings. The level of this pin is sampled after device power up. A low level selects page zero. A high level selects page one. The HW\_SW\_CTRL pin is a tri-level input pin. This third voltage level is automatically applied by an internal voltage divider. The mid-level is used to select an internal default where the serial interface is enabled.

PDN/SYNCN (pin 8) , SCL (pin 12), and SDA (pin 19) have a secondary functionality and can act as general-purpose inputs and outputs (GPIO). This means that either the serial interface or the GPIO functionality can be active.

PDN/SYNCN resets the internal circuitry and is used in the initial power-up sequence. The pin can be reconfigured to act as synchronization input. The differential outputs are kept in mute while SYNCN is low. When SYNCN is high, outputs are active.

**表 9-16. Control and GPIO Pins**

PIN NO.	NAME	TYPE	2-LEVEL INPUT	3-LEVEL INPUT	OUTPUT	TERMINATION
23	HW_SW_CTRL	Input	-	Yes	-	PUPD
20	GPIO1	Input/Output	Yes	-	Yes	PU (when Input)
19	GPIO2	Input/Output	Yes	-	Yes	Open-Drain I/O in I <sup>2</sup> C mode, CMOS (Input)
12	GPIO3	Input	Yes	-	-	-
11	GPIO4	Input/Output	Yes	-	Yes	PU (when Input)
8	PDN	Input	Yes	-	-	PU (when Input)
4	REFSEL	Input	-	Yes	-	PUPD

表 9-17. GPIO Input/Output Signal List

ABBREVIATION	TYPE	DESCRIPTION
FREQ_INC	Input	Frequency Increment; Increments the MASH numerator
FREQ_DEC	Input	Frequency Decrement; Decrements the MASH numerator
OE (global)	Input	Enables or disables all differential outputs Y[4:1] (bypass not affected)
SSC_EN	Input	Enables or disables SSC.
OE1	Input	Enables or disables OUT1
OE2	Input	Enables or disables OUT2
OE3	Input	Enables or disables OUT3
OE4	Input	Enables or disables OUT4
PLL_LOCK	Output	PLL Lock Status. 0 = PLL out of lock; 1 = indicates PLL in lock

## 9.4 Device Functional Modes

### 9.4.1 Operation Modes

The operating modes listed in 表 9-18 can be set, and the GPIOs configured. An operating mode change only becomes effective when it is loaded from the EEPROM after a power cycle.

表 9-18. Modes of Operations

DESCRIPTION	MODE	REFSEL	HW_SW_CTRL	GPIO1	GPIO2	GPIO3	GPIO4
I <sup>2</sup> C + GPIO	Fall-back	M	M	I/O	SDA	SCL	I/O
OE	Pin Mode	L/H	L/H	OE1	OE2	OE3	OE4
I <sup>2</sup> C + GPIO	Serial Interface Mode	L/H	L/H	I/O	SDA	SCL	I/O

#### 9.4.1.1 Fall-Back Mode

As the programming interface can be intentionally deactivated using the EEPROM, an accidental disabling of the I<sup>2</sup>C blocks further access to the device. The serial interface can be forced using the fall-back mode. To enter this mode, the user leaves pin 4 and pin 23 floating while the supply voltage is applied to VDDREF. In this mode, EEPROM Read at power up is bypassed and device boots in default mode. In this mode, pin 11 is pre-configured as an input and pin 20 is configured as an output. After powering up in fall-back mode, the device can be re-programmed through serial interface and be re-configured for normal operation. EEPROM can also be re-programmed. The PLL would not be auto-calibrated, however, and the I<sup>2</sup>C interface would be active. This mode would allow the user to fully configure the device before re-locking the PLL.

#### 9.4.1.2 Pin Mode

In pin mode, the pins 12 and 19 are input pins which act as individual output enable pins. Together with pins 11 and 20, this allows for one output enable pin per output channel.

#### 9.4.1.3 Serial Interface Mode

In serial interface mode, pins 12 and 19 are configured as an I<sup>2</sup>C interface.

## 9.5 Programming

### 9.5.1 I<sup>2</sup>C Serial Interface

The CDCE6214-Q1 ultra-low power clock generator provides an I<sup>2</sup>C-compatible serial interface for register and EEPROM access. The device is compatible to standard-mode I<sup>2</sup>C at 100 kHz and the fast-mode I<sup>2</sup>C at 400-kHz clock frequency.

1. In fall-back mode, I<sup>2</sup>C slave address = 67h.
2. In other modes, I<sup>2</sup>C slave address = 68h (Default).

3. The LSB bit of the device can be programmed in the EEPROM. For example, if I2C\_A0 is programmed H in Page 0 of EEPROM, setting HW\_SW\_CTRL=0 would set I<sup>2</sup>C address as 69h.
4. Two devices with EEPROM + 1 device in fall-back mode can be used on the same I<sup>2</sup>C bus with addresses 67h, 68h and 69h.

**表 9-19. I<sup>2</sup>C-Compatible Serial Interface, Slave Address Byte** <sup>16 17</sup>

7	6	5	4	3	2	1	0
Slave Address [6:0]							R/W# Bit

**表 9-20. I<sup>2</sup>C-Compatible Serial Interface, Programmable Slave Address** <sup>18 19</sup>

A6	A5	A4	A3	A2	A1	A0	HW_SW_SEL	DESCRIPTION
1	1	0	0	1	1	1	MID	Fall-back Mode
1	1	0	1	0	0	I2C_A0	LOW	EEPROM Page 0
1	1	0	1	0	0	I2C_A0	HIGH	EEPROM Page 1

The serial interface uses the following protocol as shown in [图 9-11](#). The slave address is followed by a word-wide register offset and a word-wide register value.

<sup>16</sup> The slave address consists of two sections. The hardwired MSBs A[6:1] and the software-selectable LSBs A[0].

<sup>17</sup> The R/W# bit indicates a read (1) or a write (0) transfer.

<sup>18</sup> In EEPROM Page 0, Serial Interface is not available. Device configured in Pin Mode

<sup>19</sup> In EEPROM Page 1, I2C\_A0 is programmed as 0, Expected Slave Address is 68h

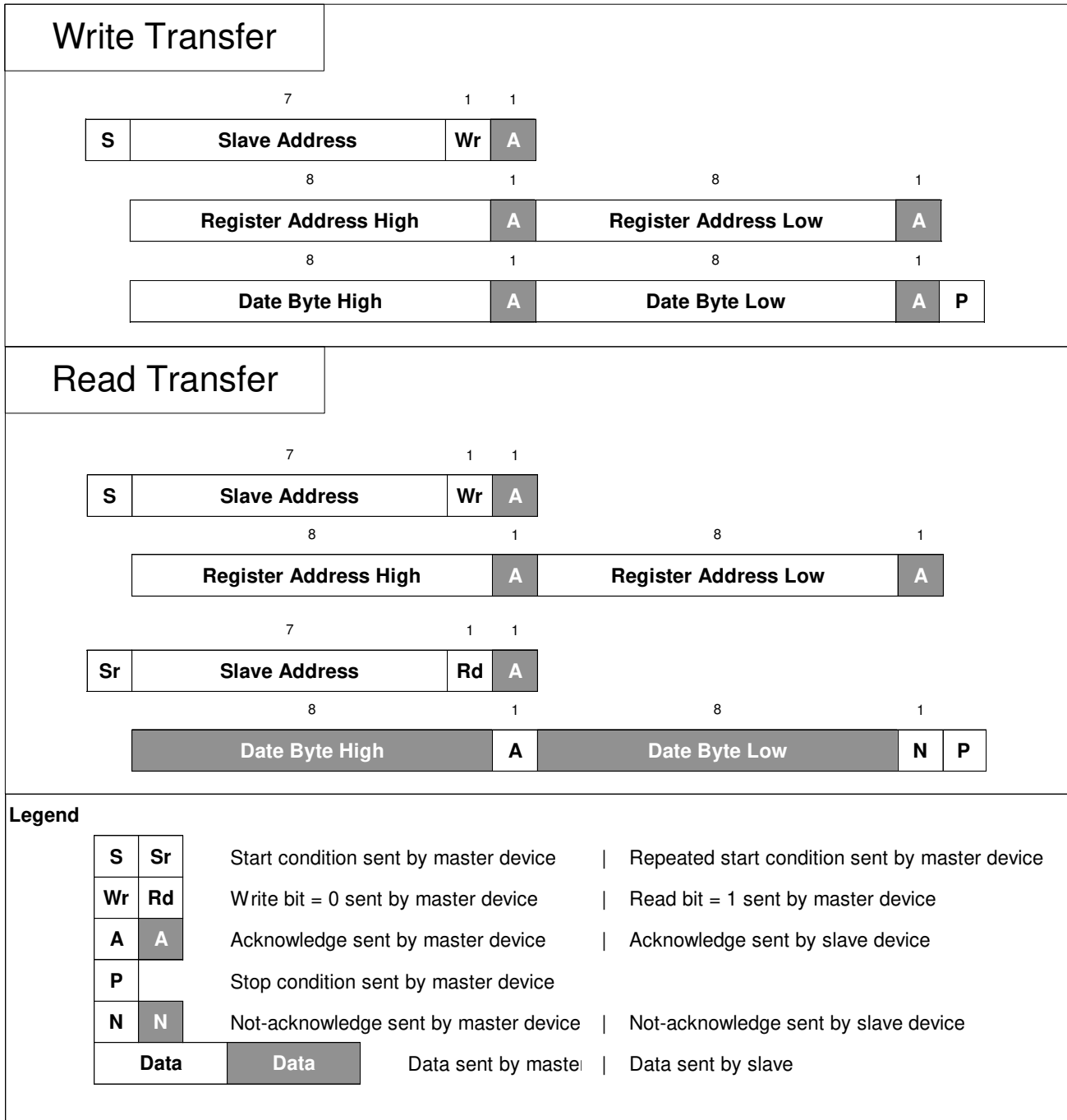

### Legend

S	Sr		Start condition sent by master device		Repeated start condition sent by master device
Wr	Rd		Write bit = 0 sent by master device		Read bit = 1 sent by master device
A	A		Acknowledge sent by master device		Acknowledge sent by slave device
P			Stop condition sent by master device		
N	N		Not-acknowledge sent by master device		Not-acknowledge sent by slave device
Data	Data		Data sent by master		Data sent by slave

**图 9-11. I<sup>2</sup>C-Compatible Serial Interface, Supported Protocol**

### 9.5.2 EEPROM

#### 9.5.2.1 EEPROM - Cyclic Redundancy Check

The device contains a cyclic redundancy check (CRC) function for reads from the EEPROM to the device registers. At start-up, the EEPROM will be read internally and a CRC value calculated. One of the EEPROM words contains an earlier stored CRC value. The stored and the actual CRC value are compared and the result transferred to register. The CRC calculation can be triggered again by writing a 1 to the update\_crc bit. A mismatch between stored and calculated CRC value is informational only and non-blocking to the device



operation. Just reading back the CRC status bit and the live CRC value can speed up in-system EEPROM programming and avoid reading back each word of the EEPROM for known configurations.

The polynomial used is CCITT-CRC16:  $x^{16} + x^{12} + x^5 + 1$ .

### 9.5.2.2 Recommended Programming Procedure

TI recommends programming the registers of the device in the following way:

1. Read-back factory default EEPROM page configuration. Each device will have different EEPROM base page configuration.
2. Modify register bits.
3. Ensure that ee\_lock is set to 5h (unlock) when overwriting the EEPROM.
4. Program register addresses in descending order from 0x53 to 0x00 including all register addresses with reserved values.

### 9.5.2.3 EEPROM Access

---

#### Note

The EEPROM word write access time is typically 8 ms.

---

There are two methods to write into the internal EEPROM

1. Register Commit method.
2. EEPROM Direct Access Method

Use the following steps to bring the device into a good known configuration.

1. Power down all the supplies.
2. Apply PDN = LOW.
3. REFSEL and HW\_SW\_CTRL pins can be High, Low or High-Z. For factory programmed device, I<sup>2</sup>C interface is not available when HW\_SW\_CTRL is LOW.
4. Apply power supplies to all VDD pins. When device operation is not required, apply power supply to VDDREF.
5. Apply PDN = HIGH.
6. Use the I<sup>2</sup>C interface to configure the device.

#### 9.5.2.3.1 Register Commit Flow

In the Register Commit flow, all bits from the device registers are copied into the EEPROM. The recommended flow is:

1. Pre-configure the device as desired, except the serial interface using mode.
2. Write 1 to RECAL to calibrate the VCO in this operation mode.
3. Select the EEPROM page, to copy the register settings into, using REGCOMMIT\_PAGE.
4. Unlock the EEPROM for write access with EE\_LOCK = x5.
5. Start the register commit operation by writing 1 to REGCOMMIT.
6. Force a CRC update by writing a 1 to UPDATE\_CRC.
7. Read back the calculated CRC in NVMLCRC.
8. Store the read CRC value in the EEPROM by writing 0x3F to NVM\_WR\_ADDR and then the CRC value to NVM\_WR\_DATA.

#### 9.5.2.3.2 Direct Access Flow

In the EEPROM direct access flow, the EEPROM words are directly accessed using the address and the data bit-fields. The recommended flow is:

1. Prepare an EEPROM image consisting of 64 words of 16 bits each.
2. Unlock the EEPROM for write access with EE\_LOCK = 0x5.
3. Write the initial address offset to the address bit-field. Write a 0x00 to NVM\_WR\_ADDR.

4. Loop through the EEPROM image from address 0 to 63 by writing each word from the image to NVM\_WR\_DATA. The EEPROM word address is automatically incremented by every write access to NVM\_WR\_DATA.



图 9-12. EEPROM Direct Access Using I<sup>2</sup>C

#### 9.5.2.4 Register Bits to EEPROM Mapping

Register bits settings are mapped into EEPROM. EEPROM is divided into three segments:

- EEPROM Base Page: Selectable by connecting HW\_SW\_CTRL pin either to Logic 0 to Logic 1.
- EEPROM Page 0: Selectable by connecting HW\_SW\_CTRL pin to Logic 0.
- EEPROM Page 1: Selectable by connecting HW\_SW\_CTRL pin to Logic 1.

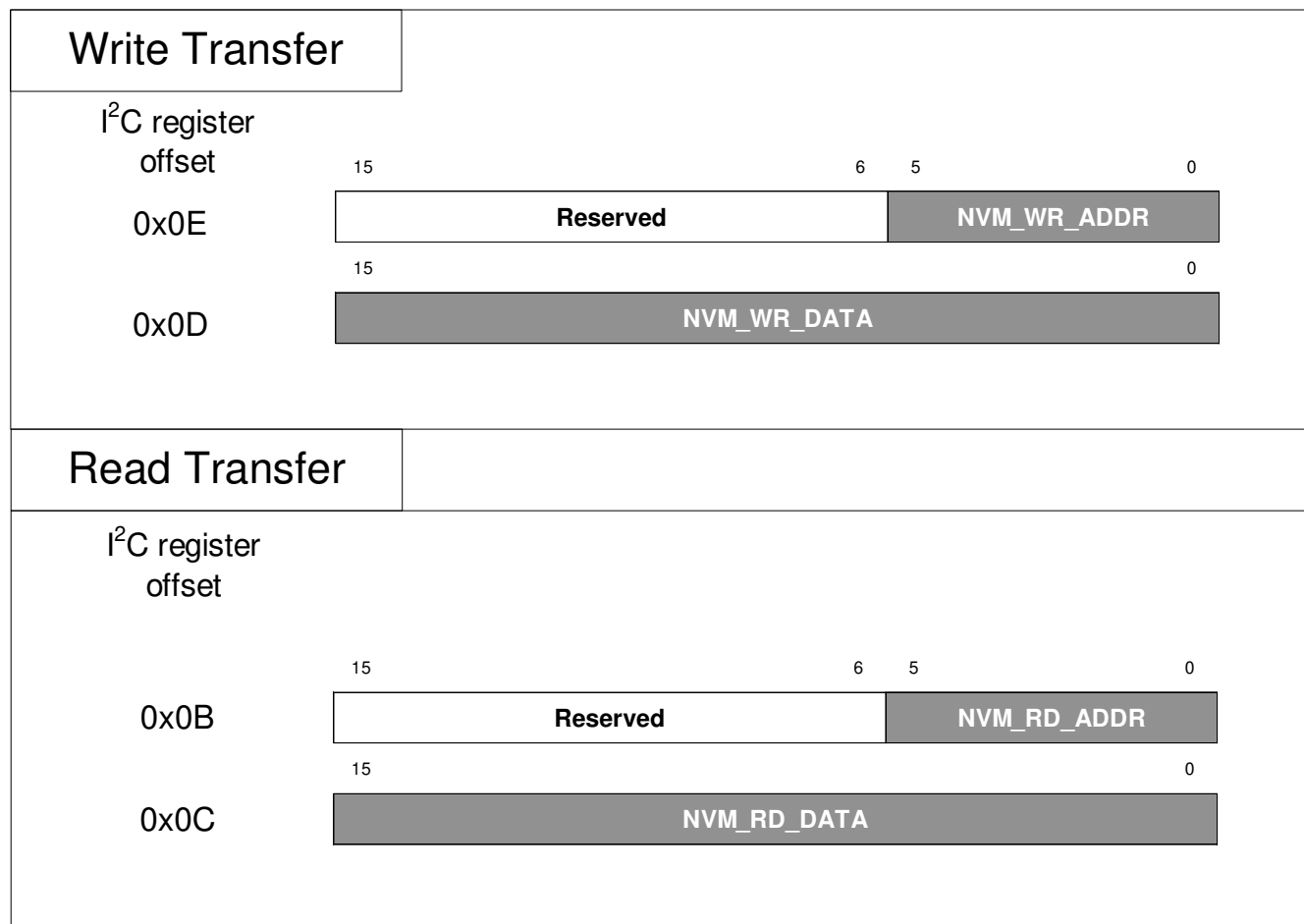
表 9-21. EEPROM Mapping <sup>20 21 22 23</sup>

	15	14	13	12	11	10	9	8	7	6	5	4	3	2	1	0
0	0	1	1	1	R5[8]	R5[7]	R5[6]	R5[5]	R5[4]	R5[1]	R4[3]	R4[2]	R4[1]	R4[0]	R3[9]	R0[3]
1	0	1	0	0	1	0	0	0	0	1	1	1	1	1	R15[5]	1
2	0	0	0	1	1	0	1	1	0	0	0	1	0	0	1	0
3	0	0	0	0	0	0	0	0	0	0	0	0	0	0	0	0
4	R48[4]	R48[3]	R48[2]	R48[1]	R48[0]	R47[1 2]	R47[1 1]	R47[1 0]	R47[9]	R47[8]	R47[7]	0	0	0	0	0

<sup>20</sup> Address Locations 0-15: EEPROM Base Page

<sup>21</sup> Address Locations 16-39: EEPROM Page 0

<sup>22</sup> Address Locations 40-63: EEPROM Page 1

<sup>23</sup> Bit locations marked in Red may vary from device to device

**表 9-21. EEPROM Mapping <sup>20 21 22 23</sup> (continued)**

	15	14	13	12	11	10	9	8	7	6	5	4	3	2	1	0
5	0	R49[4]	R49[3]	R49[2]	R49[1]	R49[0]	R48[1 4]	R48[1 3]	R48[1 2]	R48[1 1]	R48[1 0]	R48[9]	R48[8]	R48[7]	R48[6]	R48[5]
6	0	0	0	R50[1 0]	R50[9]	R50[8]	1	1	0	0	0	0	0	0	0	0
7	R55[6]	R53[6]	1	R53[2]	R53[1]	R53[0]	1	0	1	0	0	0	0	0	0	0
8	1	0	0	0	0	0	1	R58[4]	R58[3]	R58[2]	R58[1]	R58[0]	0	R55[9]	R55[8]	R55[7]
9	0	1	R60[1 5]	R60[1 4]	R60[1 3]	R60[1 2]	R60[3]	R60[2]	R60[1]	R60[0]	R59[9]	R59[8]	R59[7]	R59[6]	R59[5]	R59[4]
10	R65[8]	R65[7]	R65[6]	R65[5]	R65[4]	1	0	0	0	0	R64[9]	R64[8]	R64[7]	R64[6]	R64[5]	0
11	0	0	0	R69[9]	R69[8]	R69[7]	R69[6]	R69[5]	0	0	1	R66[3]	R66[2]	R66[1]	R66[0]	R65[9]
12	R74[5]	0	0	1	R71[3]	R71[2]	R71[1]	R71[0]	R70[9]	R70[8]	R70[7]	R70[6]	R70[5]	R70[4]	1	0
13	R76[0]	R75[9]	R75[8]	R75[7]	R75[6]	R75[5]	R75[4]	1	0	0	0	0	R74[9]	R74[8]	R74[7]	R74[6]
14	0	0	0	0	0	R79[3]	R79[2]	R79[1]	R79[0]	R76[9]	R76[8]	R76[7]	R76[6]	R76[3]	R76[2]	R76[1]
15	0	0	0	0	0	0	R81[3]	1	0	0	0	0	0	0	R80[3]	0
16	R1[6]	R1[5]	R1[4]	R1[3]	R1[2]	R1[1]	R1[0]	R0[15]	R0[14]	R0[13]	R0[12]	0	R0[10]	0	R0[8]	R0[0]
17	R2[6]	R2[5]	R2[4]	R2[3]	R2[2]	R2[1]	R2[0]	R1[15]	R1[14]	R1[13]	R1[12]	R1[11]	R1[10]	R1[9]	R1[8]	R1[7]
18	0	R5[3]	R5[2]	R4[7]	R4[6]	R4[5]	R4[4]	R3[4]	R3[3]	R2[13]	R2[12]	R2[11]	R2[10]	R2[9]	R2[8]	R2[7]
19	R24[1 5]	R24[1 2]	R24[1 1]	R24[1 0]	R24[9]	R24[8]	0	0	R24[5]	R24[4]	R24[3]	R24[2]	R24[1]	R24[0]	0	0
20	R27[0]	0	R25[1 4]	R25[1 3]	R25[1 2]	R25[1 1]	R25[1 0]	R25[9]	R25[7]	R25[6]	R25[5]	R25[4]	R25[3]	R25[2]	R25[1]	R25[0]
21	R30[1 4]	R30[1 3]	R30[1 2]	R30[1 1]	R30[1 0]	R30[9]	R30[8]	R30[7]	R30[6]	R30[5]	R30[4]	R30[3]	R30[2]	R30[1]	R30[0]	R27[1]
22	R31[1 5]	R31[1 4]	R31[1 3]	R31[1 2]	R31[1 1]	R31[1 0]	R31[9]	R31[8]	R31[7]	R31[6]	R31[5]	R31[4]	R31[3]	R31[2]	R31[1]	R31[0]
23	R33[7]	R33[6]	R33[5]	R33[4]	R33[3]	R33[2]	R33[1]	R33[0]	R32[7]	R32[6]	R32[5]	R32[4]	R32[3]	R32[2]	R32[1]	R32[0]
24	R34[7]	R34[6]	R34[5]	R34[4]	R34[3]	R34[2]	R34[1]	R34[0]	R33[1 5]	R33[1 4]	R33[1 3]	R33[1 2]	R33[1 1]	R33[1 0]	R33[9]	R33[8]
25	R43[1 0]	R43[9]	R43[8]	R43[7]	R43[6]	R43[5]	R43[4]	R43[3]	R43[2]	R43[1]	R43[0]	R42[5]	R42[3]	R42[2]	R42[1]	R41[1 5]
26	R51[1 0]	0	0	1	R51[6]	0	0	R47[6]	R47[5]	R47[4]	R47[3]	R43[1 5]	R43[1 4]	R43[1 3]	R43[1 2]	R43[1 1]
27	R56[1 0]	R56[9]	R56[8]	R56[7]	R56[6]	R56[5]	R56[4]	R56[3]	R56[2]	R56[1]	R56[0]	R53[3]	1	0	0	0
28	R57[1 4]	R57[1 2]	R57[9]	R57[8]	R57[7]	R57[6]	R57[5]	R57[4]	R57[3]	R57[1]	R57[0]	R56[1 5]	R56[1 4]	R56[1 3]	R56[1 2]	R56[1 1]
29	R62[6]	R62[5]	R62[4]	R62[3]	R62[2]	R62[1]	R62[0]	R60[1 1]	R60[1 0]	R60[5]	R60[4]	R59[1 5]	R59[1 4]	R59[1 3]	R59[1 2]	R59[1 1]
30	R63[7]	R63[6]	R63[5]	R63[4]	R63[3]	R63[1]	R63[0]	R62[1 5]	R62[1 4]	R62[1 3]	R62[1 2]	R62[1 1]	R62[1 0]	R62[9]	R62[8]	R62[7]
31	R67[6]	R67[5]	R67[4]	R67[3]	R67[2]	R67[1]	R67[0]	R66[5]	R66[4]	R65[1 4]	R65[1 3]	R65[1 1]	R63[1 3]	R63[1 2]	R63[9]	R63[8]
32	R68[7]	R68[6]	R68[5]	R68[4]	R68[3]	R68[1]	R68[0]	R67[1 5]	R67[1 4]	R67[1 3]	R67[1 2]	R67[1 1]	R67[1 0]	R67[9]	R67[8]	R67[7]
33	R72[6]	R72[5]	R72[4]	R72[3]	R72[2]	R72[1]	R72[0]	R71[1 0]	R71[9]	R71[5]	R71[4]	R70[1 1]	R68[1 3]	R68[1 2]	R68[9]	R68[8]

<sup>20</sup> Address Locations 0-15: EEPROM Base Page  
<sup>21</sup> Address Locations 16-39: EEPROM Page 0  
<sup>22</sup> Address Locations 40-63: EEPROM Page 1  
<sup>23</sup> Bit locations marked in Red may vary from device to device

**表 9-21. EEPROM Mapping <sup>20 21 22 23</sup> (continued)**

	15	14	13	12	11	10	9	8	7	6	5	4	3	2	1	0
34	R73[7]	R73[6]	R73[5]	R73[4]	R73[3]	R73[1]	R73[0]	R72[1 5]	R72[1 4]	R72[1 3]	R72[1 2]	R72[1 1]	R72[1 0]	R72[9]	R72[8]	R72[7]
35	0	0	0	R77[1]	R77[0]	R76[5]	R76[4]	R75[1 5]	R75[1 4]	R75[1 3]	R75[1 2]	R75[1 1]	R73[1 3]	R73[1 2]	R73[9]	R73[8]
36	0	0	0	0	0	0	0	0	0	R79[9]	R78[1 2]	0	0	0	0	0
37	0	0	0	0	0	0	0	0	0	0	0	0	0	0	0	0
38	0	0	0	0	0	0	0	0	0	0	0	0	0	0	0	0
39	0	0	0	1	0	0	0	0	0	0	0	0	0	0	0	0
40	R1[6]	R1[5]	R1[4]	R1[3]	R1[2]	R1[1]	R1[0]	R0[15]	R0[14]	R0[13]	R0[12]	0	R0[10]	0	R0[8]	R0[0]
41	R2[6]	R2[5]	R2[4]	R2[3]	R2[2]	R2[1]	R2[0]	R1[15]	R1[14]	R1[13]	R1[12]	R1[11]	R1[10]	R1[9]	R1[8]	R1[7]
42	0	R5[3]	R5[2]	R4[7]	R4[6]	R4[5]	R4[4]	R3[4]	R3[3]	R2[13]	R2[12]	R2[11]	R2[10]	R2[9]	R2[8]	R2[7]
43	R24[1 5]	R24[1 2]	R24[1 1]	R24[1 0]	R24[9]	R24[8]	0	0	R24[5]	R24[4]	R24[3]	R24[2]	R24[1]	R24[0]	0	0
44	R27[0]	0	R25[1 4]	R25[1 3]	R25[1 2]	R25[1 1]	R25[1 0]	R25[9]	R25[7]	R25[6]	R25[5]	R25[4]	R25[3]	R25[2]	R25[1]	R25[0]
45	R30[1 4]	R30[1 3]	R30[1 2]	R30[1 1]	R30[1 0]	R30[9]	R30[8]	R30[7]	R30[6]	R30[5]	R30[4]	R30[3]	R30[2]	R30[1]	R30[0]	R27[1]
46	R31[1 5]	R31[1 4]	R31[1 3]	R31[1 2]	R31[1 1]	R31[1 0]	R31[9]	R31[8]	R31[7]	R31[6]	R31[5]	R31[4]	R31[3]	R31[2]	R31[1]	R31[0]
47	R33[7]	R33[6]	R33[5]	R33[4]	R33[3]	R33[2]	R33[1]	R33[0]	R32[7]	R32[6]	R32[5]	R32[4]	R32[3]	R32[2]	R32[1]	R32[0]
48	R34[7]	R34[6]	R34[5]	R34[4]	R34[3]	R34[2]	R34[1]	R34[0]	R33[1 5]	R33[1 4]	R33[1 3]	R33[1 2]	R33[1 1]	R33[1 0]	R33[9]	R33[8]
49	R43[1 0]	R43[9]	R43[8]	R43[7]	R43[6]	R43[5]	R43[4]	R43[3]	R43[2]	R43[1]	R43[0]	R42[5]	R42[3]	R42[2]	R42[1]	R41[1 5]
50	R51[1 0]	0	0	1	R51[6]	0	0	R47[6]	R47[5]	R47[4]	R47[3]	R43[1 5]	R43[1 4]	R43[1 3]	R43[1 2]	R43[1 1]
51	R56[1 0]	R56[9]	R56[8]	R56[7]	R56[6]	R56[5]	R56[4]	R56[3]	R56[2]	R56[1]	R56[0]	R53[3]	1	0	0	0
52	R57[1 4]	R57[1 2]	R57[9]	R57[8]	R57[7]	R57[6]	R57[5]	R57[4]	R57[3]	R57[1]	R57[0]	R56[1 5]	R56[1 4]	R56[1 3]	R56[1 2]	R56[1 1]
53	R62[6]	R62[5]	R62[4]	R62[3]	R62[2]	R62[1]	R62[0]	R60[1 1]	R60[1 0]	R60[5]	R60[4]	R59[1 5]	R59[1 4]	R59[1 3]	R59[1 2]	R59[1 1]
54	R63[7]	R63[6]	R63[5]	R63[4]	R63[3]	R63[1]	R63[0]	R62[1 5]	R62[1 4]	R62[1 3]	R62[1 2]	R62[1 1]	R62[1 0]	R62[9]	R62[8]	R62[7]
55	R67[6]	R67[5]	R67[4]	R67[3]	R67[2]	R67[1]	R67[0]	R66[5]	R66[4]	R65[1 4]	R65[1 3]	R65[1 1]	R63[1 3]	R63[1 2]	R63[9]	R63[8]
56	R68[7]	R68[6]	R68[5]	R68[4]	R68[3]	R68[1]	R68[0]	R67[1 5]	R67[1 4]	R67[1 3]	R67[1 2]	R67[1 1]	R67[1 0]	R67[9]	R67[8]	R67[7]
57	R72[6]	R72[5]	R72[4]	R72[3]	R72[2]	R72[1]	R72[0]	R71[1 0]	R71[9]	R71[5]	R71[4]	R70[1 1]	R68[1 3]	R68[1 2]	R68[9]	R68[8]
58	R73[7]	R73[6]	R73[5]	R73[4]	R73[3]	R73[1]	R73[0]	R72[1 5]	R72[1 4]	R72[1 3]	R72[1 2]	R72[1 1]	R72[1 0]	R72[9]	R72[8]	R72[7]
59	0	0	0	R77[1]	R77[0]	R76[5]	R76[4]	R75[1 5]	R75[1 4]	R75[1 3]	R75[1 2]	R75[1 1]	R73[1 3]	R73[1 2]	R73[9]	R73[8]
60	0	0	0	0	0	0	0	0	0	R79[9]	R78[1 2]	0	0	0	0	0
61	0	0	0	0	0	0	0	0	0	0	0	0	0	0	0	0

<sup>20</sup> Address Locations 0-15: EEPROM Base Page  
<sup>21</sup> Address Locations 16-39: EEPROM Page 0  
<sup>22</sup> Address Locations 40-63: EEPROM Page 1  
<sup>23</sup> Bit locations marked in Red may vary from device to device

**表 9-21. EEPROM Mapping <sup>20 21 22 23</sup> (continued)**

	15	14	13	12	11	10	9	8	7	6	5	4	3	2	1	0
62	0	0	0	0	0	0	0	0	0	0	0	0	0	0	0	0
63	SCRC[ 15]	SCRC[ 14]	SCRC[ 13]	SCRC[ 12]	SCRC[ 11]	SCRC[ 10]	SCRC[ 9]	SCRC[ 8]	SCRC[ 7]	SCRC[ 6]	SCRC[ 5]	SCRC[ 4]	SCRC[ 3]	SCRC[ 2]	SCRC[ 1]	SCRC[ 0]

**表 9-22. Register Defaults in Fall-Back Mode and EEPROM Mode**

REGISTER ADDRESSES	FALL-BACK MODE	HW_SW_CTRL = 0	HW_SW_CTRL = 1	REGISTER ADDRESSES	FALL-BACK MODE	HW_SW_CTRL = 0	HW_SW_CTRL = 1
R85	x0000	x0000	x0000	R42	x0002	x0002	x0002
R84	x0000	x0000	x0000	R41	x0000	x0000	x0000
R83	x0000	xFF00	xFF00	R40	x0000	x0000	x0000
R82	x0000	x01C0	x01C0	R39	x0000	x0000	x0000
R81	x0004	x0004	x0004	R38	x0000	x0000	x0000
R80	x0000	x0008	x0008	R37	x0000	x0000	x0000
R79	x0008	x0008	x0008	R36	x0000	x0000	x0000
R78	x1000	x0000	x0000	R35	x0000	x0028	x0028
R77	x0000	x0002	x0002	R34	x0000	x0000	x0000
R76	x0008	x0188	x0188	R33	x0000	x0000	x0000
R75	x0008	x0008	x8008	R32	x0000	x0000	x0000
R74	xA181	xA181	xA181	R31	x0000	x0000	x0000
R73	x2000	x2000	x0000	R30	x0030	x0030	x0030
R72	x0006	x0006	x0006	R29	x0000	x0000	x0000
R71	x0000	x0406	x0406	R28	x0000	x0000	x0000
R70	x0008	x0008	x0808	R27	x0005	x0004	x0004
R69	xA181	xA181	xA181	R26	x0000	x0000	x0000
R68	x2000	x2000	x0000	R25	x0400	x0400	x0400
R67	x0006	x0006	x0006	R24	x0718	x091C	x091C
R66	x0000	x0006	x0006	R23	x0000	x2406	x2406
R65	x0008	x4008	x4808	R22	x06A2	x06A2	x06A2
R64	xA181	xA181	xA181	R21	x0000	x0590	x0513
R63	x2000	x2000	x0000	R20	x0000	x0000	x0000
R62	x0006	x0006	x0006	R19	x0000	x0000	x0000
R61	x0000	x0000	x0000	R18	x0000	x0000	x0000
R60	x0008	x0008	x6028	R17	x26C4	x26C4	x26C4
R59	x0008	x0008	x8008	R16	x921F	x921F	x921F
R58	x502C	x502C	x502C	R15	xA037	xA037	xA037
R57	x4000	x4000	x0000	R14	x0000	x0000	x0000
R56	x0006	x0006	x0006	R13	x0000	x0000	x0000
R55	x001E	x001E	x001E	R12	x0000	x0000	x7002
R54	x3400	x3400	x3400	R11	x0000	x0000	x003F
R53	x0069	x0069	x0069	R10	x0000	xA777	xA777
R52	x5000	x5000	x5000	R9	x0000	x7BFA	xA777
R51	x40C0	x40C0	x40C0	R8	x0000	x0001	x0001
R50	x01C0	x01C0	x01C0	R7	x0000	x0C2D	x0C0D
R49	x0013	x0013	x0013	R6	x0000	x0E6C	x0E6C
R48	x1A14	x1A05	x1A05	R5	x0008	x0008	x0008
R47	x0A00	x0280	x0280	R4	x0000	x0000	x0000

<sup>20</sup> Address Locations 0-15: EEPROM Base Page  
<sup>21</sup> Address Locations 16-39: EEPROM Page 0  
<sup>22</sup> Address Locations 40-63: EEPROM Page 1  
<sup>23</sup> Bit locations marked in Red may vary from device to device

**表 9-22. Register Defaults in Fall-Back Mode and EEPROM Mode (continued)**

REGISTER ADDRESSES	FALL-BACK MODE	HW_SW_CTRL = 0	HW_SW_CTRL = 1	REGISTER ADDRESSES	FALL-BACK MODE	HW_SW_CTRL = 0	HW_SW_CTRL = 1
R46	x0000	x0000	x0000	R3	x0000	x0200	x0200
R45	x4F80	x4F80	x4F80	R2	x0000	x0000	x0000
R44	x0318	x0318	x0318	R1	x2310	x7654	x7652
R43	x0051	x0051	x0051	R0	x0000	x0001	x2000

## 10 Application and Implementation

### Note

以下应用部分中的信息不属于 TI 器件规格的范围，TI 不担保其准确性和完整性。TI 的客户应负责确定器件是否适用于其应用。客户应验证并测试其设计，以确保系统功能。

### 10.1 Application Information

A typical application using the I<sup>2</sup>C interface and a 25-MHz crystal input is shown in 图 10-1. The two ends of 25-MHz XTAL are connected to pin 1 and 2. The REFSEL pin is pulled down to select a secondary input. The HW\_SW\_CTRL can be pulled either low or high if EEPROM is used, or kept floating if EEPROM is unused. 1.8 V, 2.5 V, or 3.3 V can be supplied to the VDD\_REF and VDD\_VCO pins, as well as VDDO\_12 and VDDO\_34 pins with filtering. Data and clock lines of I2C must be pulled to VDD\_REF using pullup resistors. The PDN can be connected to the MCU if a hardware reset is required, otherwise it can be left floating. The GPIO1 and 4 pins can be connected to the MCU if needed, otherwise they can be left floating. Unused outputs can be left floating.



图 10-1. Typical Application Schematic With I<sup>2</sup>C Interface

## 10.2 Typical Application

图 10-2 图 10-2 shows typical block diagram for eAVB system using CDCE6214-Q1.

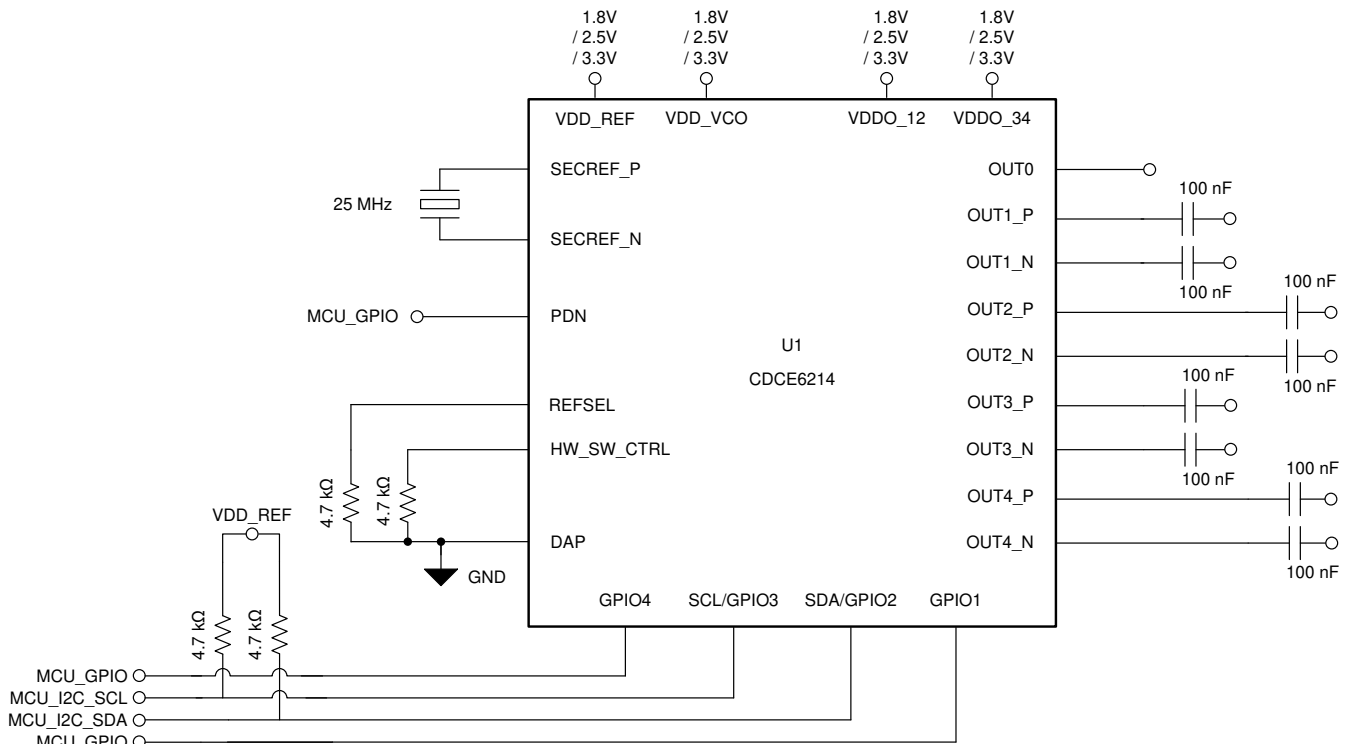

图 10-2. eAVB System Block Diagram Using CDCE6214-Q1

### 10.2.1 Design Requirements

For designs with the CDCE6214-Q1, the designer must select:

- a primary or secondary input
- an input type
- an input frequency
- a device communication mode ( $I^2C$  and/or EEPROM)
- the required device operation modes to configure the connections of GPIO pins
- a supply voltage (1.8 V, 2.5 V, or 3.3 V)
- a digital reference (1.8 V, 2.5 V, or 3.3 V)
- an output reference (1.8 V, 2.5 V, or 3.3 V)
- an output format

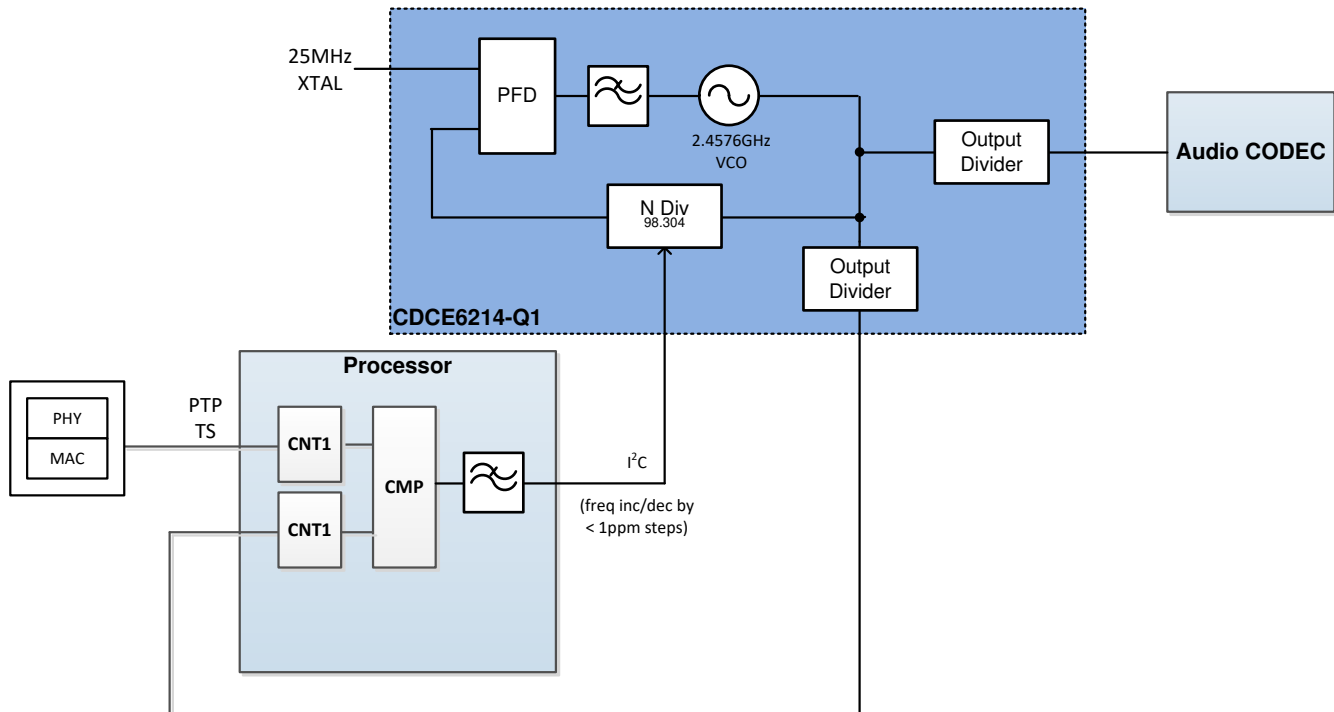
### 10.2.2 Detailed Design Procedure

The CDCE6214-Q1 is designed for ease-of-use. To power up the device:

1. Either tie the power supply pin (VDD\_REF, VDD\_VCO, VDDO\_12 and VDDO\_34) together or independently connect them to the 1.8-V, 2.5-V, or 3.3-V power supply.
2. Solder the GND Pin (DAP) to the PCB Plane.
3. Ensure that the REFSEL, HW\_SW\_CTRL, and PDN configuration pins are appropriately connected:
  - a. Internally connect the PDN pin to VDD\_REF through a pullup resistor. When floating, the PDN pin would automatically release device from PDN.
  - b. If PDN pin is low, the device will not respond to I2C commands.
  - c. REFSEL and HW\_SW\_CTRL are tri-level pins. If left floating, the device will start in fall-back mode.



The device is factory-configured to provide:

- 100-MHz LVDS with 25-MHz XTAL when HW\_SW\_CTRL=L. The 25-MHz output on OUT0 is enabled.
- 100-MHz LP-HCSL with 25-MHz XTAL and HW\_SW\_CTRL = H. The 25-MHz output on OUT0 is enabled.

### 10.2.3 Application Curves

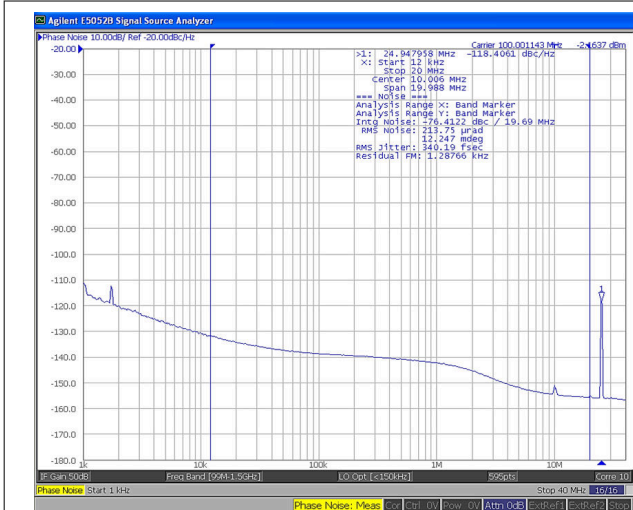

Reference: Crystal Closed-Loop Phase 100-MHz LP-HCSL  
Input 25 MHz Noise from 2.4-GHz VCO

**图 10-3. 100-MHz LP-HCSL Output for PCIe Application**

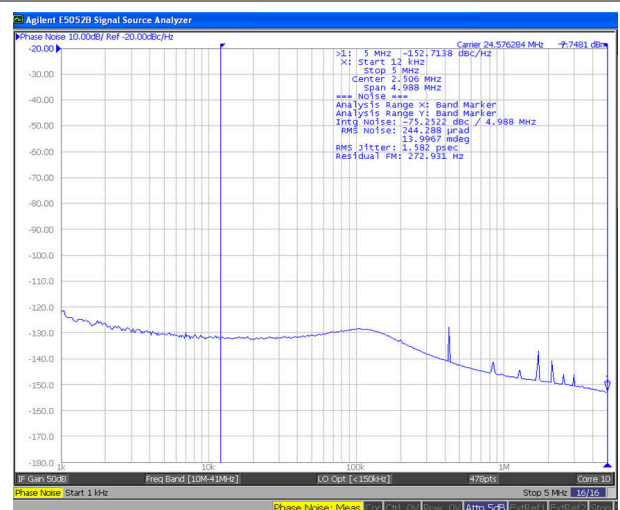

Reference: Crystal Closed-Loop Phase 24.576-MHz  
Input 25 MHz Noise from 2.4576-GHz LVCMOS VCO

**图 10-4. 24.576MHz LVCMOS Output for Audio Clcking**

## 11 Power Supply Recommendations

The CDCE6214-Q1 provides multiple power supply pins. Each power supply supports 1.8 V, 2.5 V, or 3.3 V. Internal low-dropout regulators (LDO) source the internal blocks and allow each pin to be supplied with its individual supply voltage. The VDD\_REF pin supplies the control pins and the serial interface. Therefore, any pullup resistors shall be connected to the same domain as VDD\_REF. VDD\_VCO powers all PLL blocks. VDDO\_12 powers outputs OUT1 and OUT2. VDDO\_34 powers OUT0, OUT3, and OUT4.

VDD\_REF and VDDO\_34 can be used for level translation operation on OUT0.

### 11.1 Power-Up Sequence

There are no restrictions from the device for applying power to the supply pins. From an application perspective, TI recommends to either apply all the VDDs at the same time or apply the VDDREF first. The digital core is connected to VDDREF and thus the settings of the EEPROM are applied automatically.

### 11.2 Decoupling

TI recommends isolating all power supplies using a ferrite bead and provide decoupling for each of the supplies. TI also recommends optimizing the decoupling for the respective layout, and consider the power supply impedance to optimize for the individual frequency plan.

An example for a decoupling per supply pin: 1x 4.7  $\mu$ F, 1x 470 nF, and 1x 100 nF.

## 12 Layout

### 12.1 Layout Guidelines

For this example, follow these guidelines:

- Isolate inputs and outputs using a GND shield. **BROKEN\_LINK** routes all inputs and outputs as differential pairs.
- Isolate outputs to adjacent outputs when generating multiple frequencies.
- Isolate the crystal area, connect the GND pads of the crystal package and flood the adjacent area. [图 12-2](#) shows a foot print which supports multiple crystal sizes.
- Try to avoid impedance jumps in the fan-in and fan-out areas when possible.
- Use five VIAs to connect the thermal pad to a solid GND plane. Full-through VIAs are preferred.
- Place decoupling capacitors with small capacitance values very close to the supply pins. Try to place them very close on the same layer or directly on the backside layer. Larger values can be placed more far away. [图 12-2](#) shows three decoupling capacitors close to the device. Ferrite beads are recommended to isolate the different frequency domains and the VDD\_VCO domain.
- Preferably use multiple VIAs to connect wide supply traces to the respective power planes.

### 12.2 Layout Examples

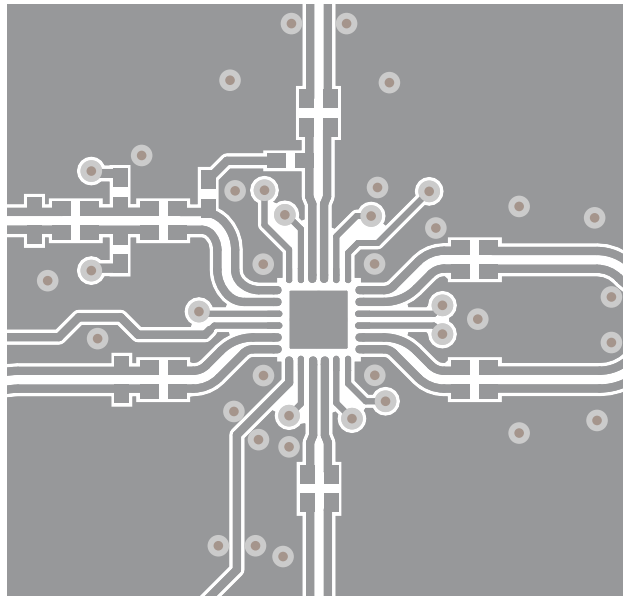

[图 12-1](#). Layout Example, Top Layer



图 12-2. Layout Example, Bottom Layer

## 13 Device and Documentation Support

### 13.1 Device Support

#### 13.1.1 Development Support

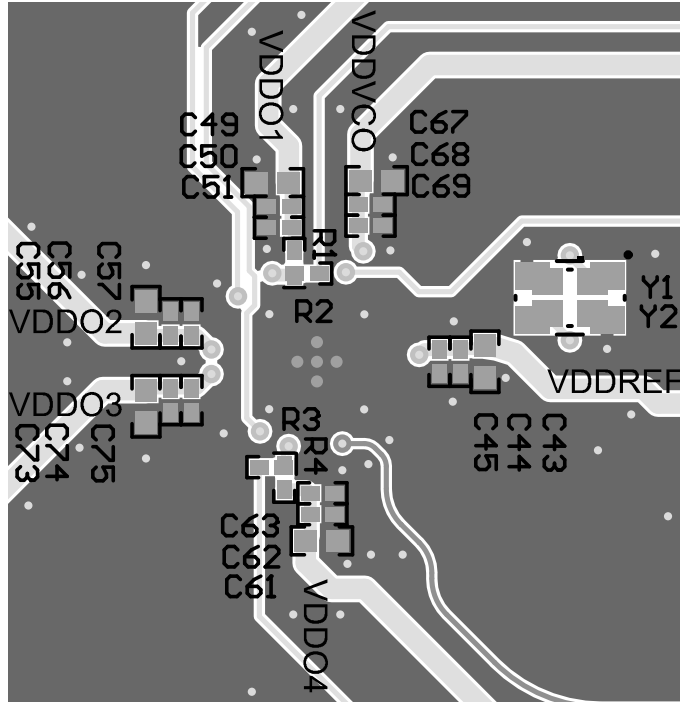
Contact your TI representative for more information.

#### 13.1.2 Device Nomenclature

CDCE6214-Q1 - 62= clock generator 1= 1x PLL 4=4x outputs E = EEPROM, integer and fractional output dividers

### 13.2 接收文档更新通知

要接收文档更新通知，请导航至 [ti.com](http://ti.com) 上的器件产品文件夹。点击 [订阅更新](#) 进行注册，即可每周接收产品信息更改摘要。有关更改的详细信息，请查看任何已修订文档中包含的修订历史记录。

### 13.3 支持资源

[TI E2E™ 支持论坛](#) 是工程师的重要参考资料，可直接从专家获得快速、经过验证的解答和设计帮助。搜索现有解答或提出自己的问题可获得所需的快速设计帮助。

链接的内容由各个贡献者“按原样”提供。这些内容并不构成 TI 技术规范，并且不一定反映 TI 的观点；请参阅 TI 的《[使用条款](#)》。

### 13.4 Trademarks

TI E2E™ is a trademark of Texas Instruments.

所有商标均为其各自所有者的财产。

### 13.5 Electrostatic Discharge Caution



This integrated circuit can be damaged by ESD. Texas Instruments recommends that all integrated circuits be handled with appropriate precautions. Failure to observe proper handling and installation procedures can cause damage.

ESD damage can range from subtle performance degradation to complete device failure. Precision integrated circuits may be more susceptible to damage because very small parametric changes could cause the device not to meet its published specifications.

### 13.6 术语表

[TI 术语表](#) 本术语表列出并解释了术语、首字母缩略词和定义。

## 14 Mechanical, Packaging, and Orderable Information

The following pages include mechanical, packaging, and orderable information. This information is the most current data available for the designated devices. This data is subject to change without notice and revision of this document. For browser-based versions of this data sheet, refer to the left-hand navigation.

**RGE0024P**

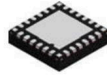

**PACKAGE OUTLINE**

**VQFN - 0.9 mm max height**

PLASTIC QUAD FLATPACK - NO LEAD

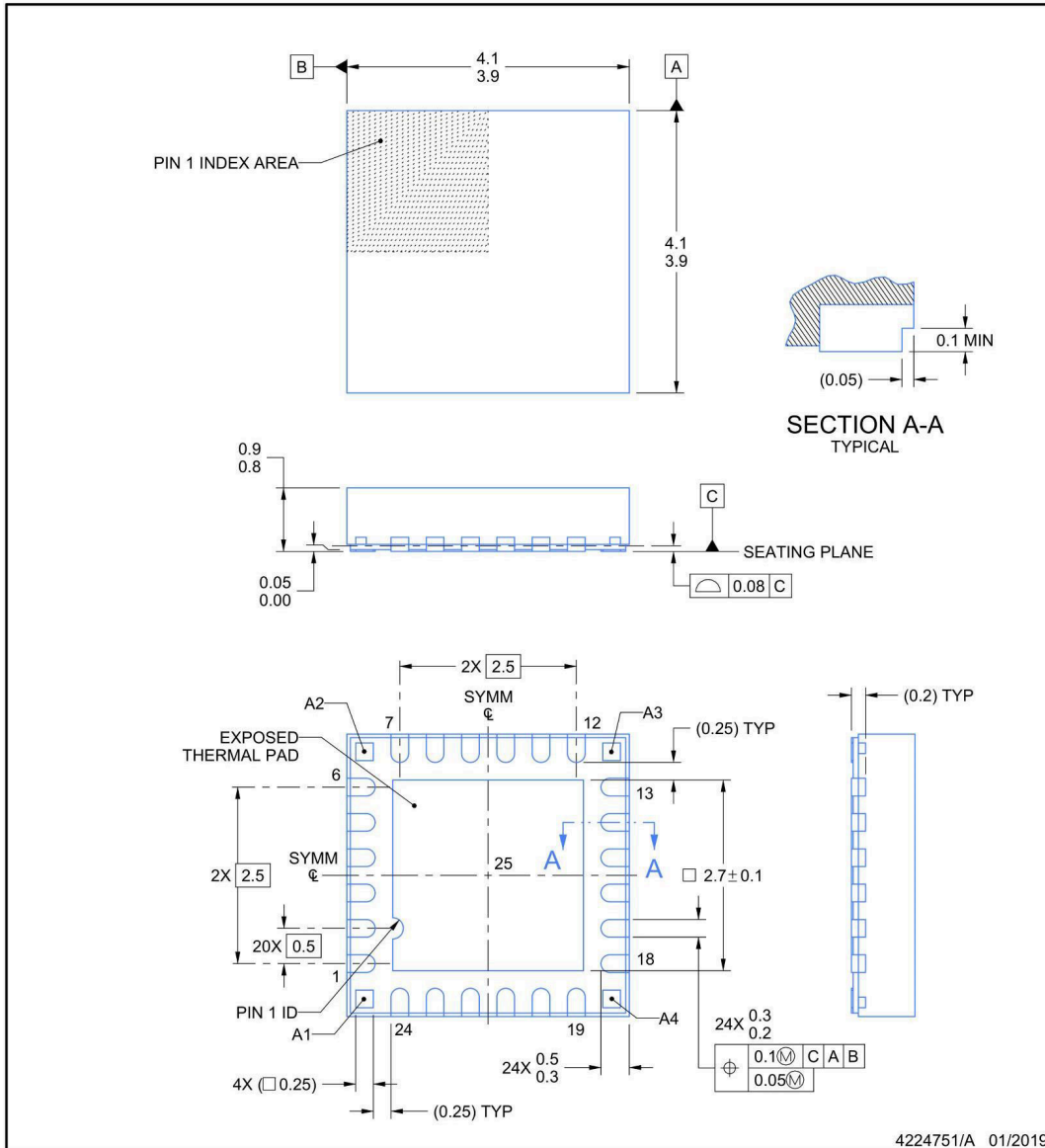

NOTES:

1. All linear dimensions are in millimeters. Any dimensions in parenthesis are for reference only. Dimensioning and tolerancing per ASME Y14.5M.
2. This drawing is subject to change without notice.
3. The package thermal pad must be soldered to the printed circuit board for thermal and mechanical performance.

## EXAMPLE BOARD LAYOUT

**RGE0024P**

**VQFN - 0.9 mm max height**

PLASTIC QUAD FLATPACK - NO LEAD

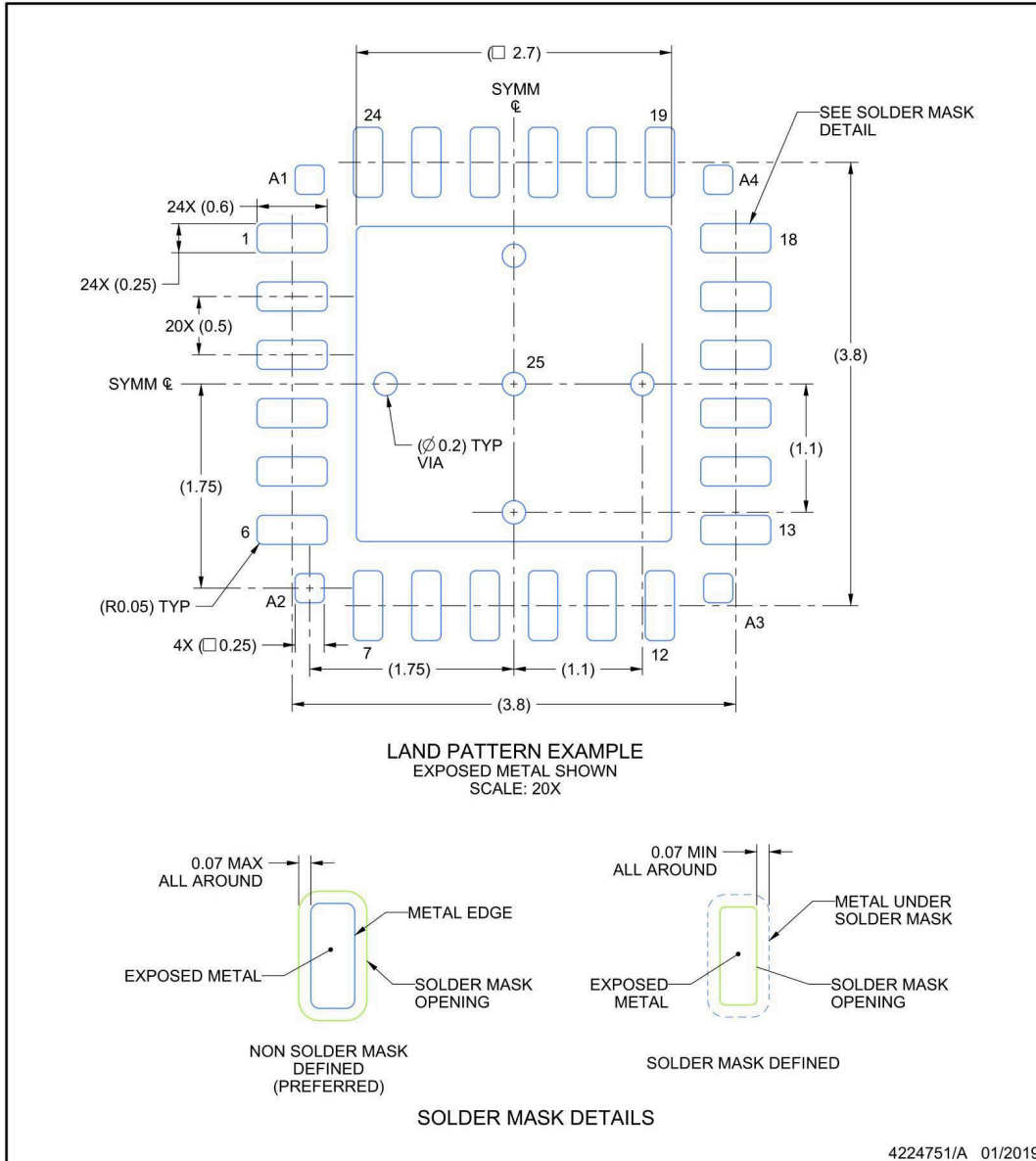

NOTES: (continued)

4. This package is designed to be soldered to a thermal pad on the board. For more information, see Texas Instruments literature number SLUA271 ([www.ti.com/lit/slua271](http://www.ti.com/lit/slua271)).
5. Vias are optional depending on application, refer to device data sheet. If any vias are implemented, refer to their locations shown on this view. It is recommended that vias under paste be filled, plugged or tented.

## EXAMPLE STENCIL DESIGN

**RGE0024P**

**VQFN - 0.9 mm max height**

PLASTIC QUAD FLATPACK - NO LEAD

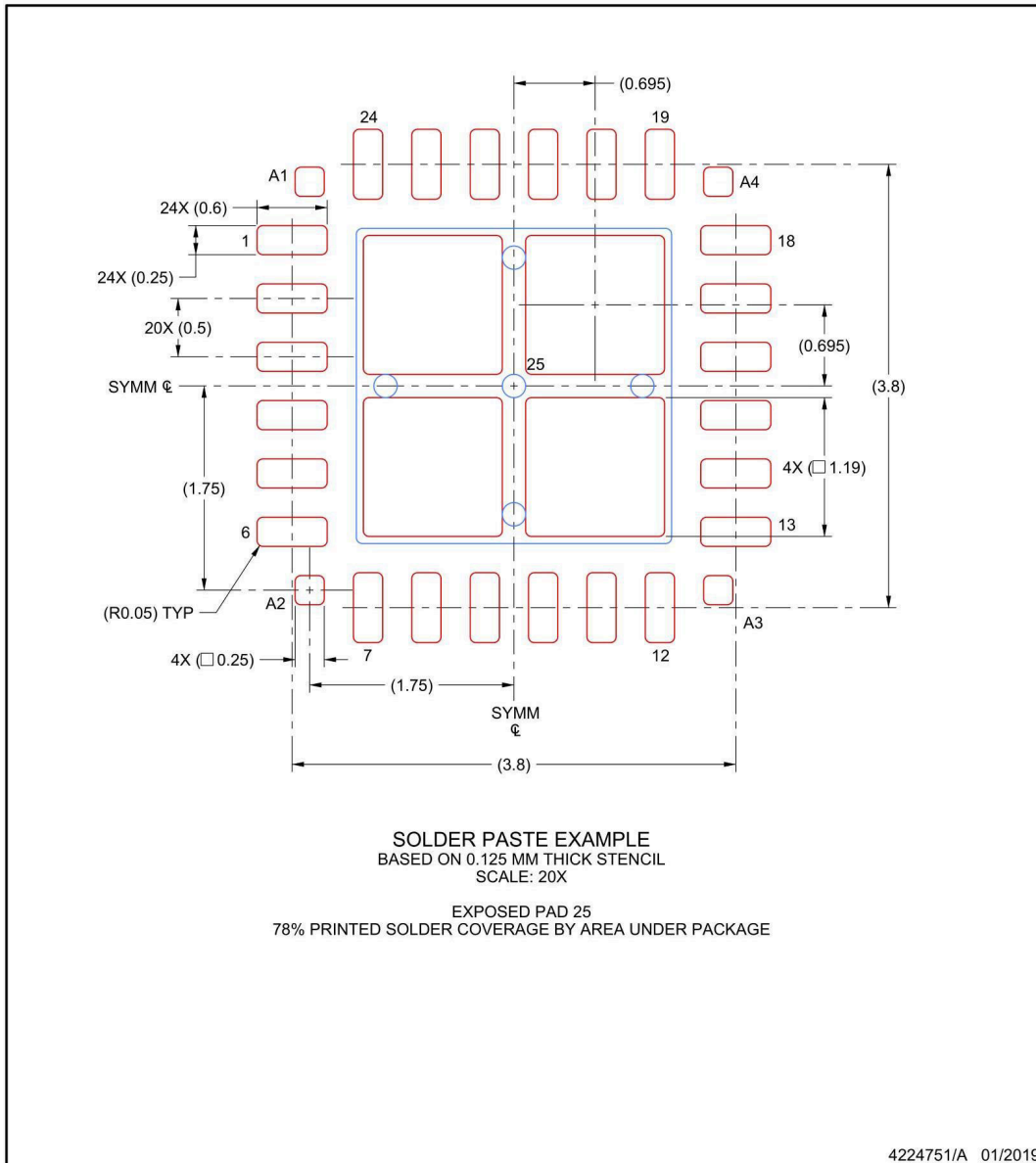



NOTES: (continued)

6. Laser cutting apertures with trapezoidal walls and rounded corners may offer better paste release. IPC-7525 may have alternate design recommendations.



**PACKAGING INFORMATION**

Orderable Device	Status (1)	Package Type	Package Drawing	Pins	Package Qty	Eco Plan (2)	Lead finish/ Ball material (6)	MSL Peak Temp (3)	Op Temp (°C)	Device Marking (4/5)	Samples
CDCE6214TWRGERQ1	ACTIVE	VQFN	RGE	24	3000	RoHS & Green	SN	Level-2-260C-1 YEAR	-40 to 105	6214Q1 A2Z	
CDCE6214TWRGETQ1	ACTIVE	VQFN	RGE	24	250	RoHS & Green	SN	Level-2-260C-1 YEAR	-40 to 105	6214Q1 A2Z	

(1) The marketing status values are defined as follows:

**ACTIVE:** Product device recommended for new designs.

**LIFEBUY:** TI has announced that the device will be discontinued, and a lifetime-buy period is in effect.

**NRND:** Not recommended for new designs. Device is in production to support existing customers, but TI does not recommend using this part in a new design.

**PREVIEW:** Device has been announced but is not in production. Samples may or may not be available.

**OBSOLETE:** TI has discontinued the production of the device.

(2) **RoHS:** TI defines "RoHS" to mean semiconductor products that are compliant with the current EU RoHS requirements for all 10 RoHS substances, including the requirement that RoHS substance do not exceed 0.1% by weight in homogeneous materials. Where designed to be soldered at high temperatures, "RoHS" products are suitable for use in specified lead-free processes. TI may reference these types of products as "Pb-Free".

**RoHS Exempt:** TI defines "RoHS Exempt" to mean products that contain lead but are compliant with EU RoHS pursuant to a specific EU RoHS exemption.

**Green:** TI defines "Green" to mean the content of Chlorine (Cl) and Bromine (Br) based flame retardants meet JS709B low halogen requirements of <=1000ppm threshold. Antimony trioxide based flame retardants must also meet the <=1000ppm threshold requirement.

(3) MSL, Peak Temp. - The Moisture Sensitivity Level rating according to the JEDEC industry standard classifications, and peak solder temperature.

(4) There may be additional marking, which relates to the logo, the lot trace code information, or the environmental category on the device.

(5) Multiple Device Markings will be inside parentheses. Only one Device Marking contained in parentheses and separated by a "~" will appear on a device. If a line is indented then it is a continuation of the previous line and the two combined represent the entire Device Marking for that device.

(6) Lead finish/Ball material - Orderable Devices may have multiple material finish options. Finish options are separated by a vertical ruled line. Lead finish/Ball material values may wrap to two lines if the finish value exceeds the maximum column width.

**Important Information and Disclaimer:**The information provided on this page represents TI's knowledge and belief as of the date that it is provided. TI bases its knowledge and belief on information provided by third parties, and makes no representation or warranty as to the accuracy of such information. Efforts are underway to better integrate information from third parties. TI has taken and continues to take reasonable steps to provide representative and accurate information but may not have conducted destructive testing or chemical analysis on incoming materials and chemicals. TI and TI suppliers consider certain information to be proprietary, and thus CAS numbers and other limited information may not be available for release.

In no event shall TI's liability arising out of such information exceed the total purchase price of the TI part(s) at issue in this document sold by TI to Customer on an annual basis.

**OTHER QUALIFIED VERSIONS OF CDCE6214-Q1 :**

- Catalog : [CDCE6214](#)

## NOTE: Qualified Version Definitions:

- Catalog - TI's standard catalog product

**TAPE AND REEL INFORMATION**

**QUADRANT ASSIGNMENTS FOR PIN 1 ORIENTATION IN TAPE**

\*All dimensions are nominal

Device	Package Type	Package Drawing	Pins	SPQ	Reel Diameter (mm)	Reel Width W1 (mm)	A0 (mm)	B0 (mm)	K0 (mm)	P1 (mm)	W (mm)	Pin1 Quadrant
CDCE6214TWRGERQ1	VQFN	RGE	24	3000	330.0	12.4	4.25	4.25	1.15	8.0	12.0	Q2
CDCE6214TWRGETQ1	VQFN	RGE	24	250	180.0	12.4	4.25	4.25	1.15	8.0	12.0	Q2

**TAPE AND REEL BOX DIMENSIONS**

\*All dimensions are nominal

Device	Package Type	Package Drawing	Pins	SPQ	Length (mm)	Width (mm)	Height (mm)
CDCE6214TWRGERQ1	VQFN	RGE	24	3000	346.0	346.0	33.0
CDCE6214TWRGETQ1	VQFN	RGE	24	250	210.0	185.0	35.0

## 重要声明和免责声明

TI“按原样”提供技术和可靠性数据（包括数据表）、设计资源（包括参考设计）、应用或其他设计建议、网络工具、安全信息和其他资源，不保证没有瑕疵且不做任何明示或暗示的担保，包括但不限于对适销性、某特定用途方面的适用性或不侵犯任何第三方知识产权的暗示担保。

这些资源可供使用 TI 产品进行设计的熟练开发人员使用。您将自行承担以下全部责任：(1) 针对您的应用选择合适的 TI 产品，(2) 设计、验证并测试您的应用，(3) 确保您的应用满足相应标准以及任何其他功能安全、信息安全、监管或其他要求。

这些资源如有变更，恕不另行通知。TI 授权您仅可将这些资源用于研发本资源所述的 TI 产品的应用。严禁对这些资源进行其他复制或展示。您无权使用任何其他 TI 知识产权或任何第三方知识产权。您应全额赔偿因在这些资源的使用中对 TI 及其代表造成的任何索赔、损害、成本、损失和债务，TI 对此概不负责。

TI 提供的产品受 [TI 的销售条款](#) 或 [ti.com](#) 上其他适用条款/TI 产品随附的其他适用条款的约束。TI 提供这些资源并不会扩展或以其他方式更改 TI 针对 TI 产品发布的适用的担保或担保免责声明。

TI 反对并拒绝您可能提出的任何其他或不同的条款。

邮寄地址：Texas Instruments, Post Office Box 655303, Dallas, Texas 75265

Copyright © 2023，德州仪器 (TI) 公司