

## DS90LV011A 3V LVDS Single High Speed Differential Driver

Check for Samples: [DS90LV011A](#)

### FEATURES

- Conforms to TIA/EIA-644-A Standard
- >400Mbps (200MHz) Switching Rates
- 700 ps (100 ps Typical) Maximum Differential Skew
- 1.5 ns Maximum Propagation Delay
- Single 3.3V Power Supply
- $\pm 350$  mV Differential Signaling
- Power Off Protection (Outputs in TRI-STATE)
- Pinout Simplifies PCB Layout
- Low Power Dissipation (23 mW @ 3.3V Typical)
- SOT-23 5-Lead Package
- SOT-23 Version Pin Compatible with SN65LVDS1
- Fabricated with Advanced CMOS Process Technology
- Industrial Temperature Operating Range
  - (–40°C to +85°C)

### DESCRIPTION

The DS90LV011A is a single LVDS driver device optimized for high data rate and low power applications. The DS90LV011A is a current mode driver allowing power dissipation to remain low even at high frequency. In addition, the short circuit fault current is also minimized. The device is designed to support data rates in excess of 400Mbps (200MHz) utilizing Low Voltage Differential Signaling (LVDS) technology.

The device is in a 5-lead SOT-23 package. The LVDS outputs have been arranged for easy PCB layout. The differential driver outputs provide low EMI with its typical low output swing of 350 mV. The DS90LV011A can be paired with its companion single line receiver, the DS90LV012A, or with any of TI's LVDS receivers, to provide a high-speed LVDS interface.

### Connection Diagram

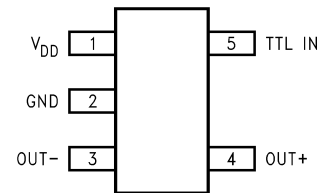

**Figure 1. Top View**  
See Package Number DBV (R-PDSO-G5)

### Functional Diagram

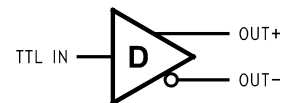

These devices have limited built-in ESD protection. The leads should be shorted together or the device placed in conductive foam during storage or handling to prevent electrostatic damage to the MOS gates.



Please be aware that an important notice concerning availability, standard warranty, and use in critical applications of Texas Instruments semiconductor products and disclaimers thereto appears at the end of this data sheet.

All trademarks are the property of their respective owners.

**Absolute Maximum Ratings<sup>(1)</sup>**

Supply Voltage ( $V_{DD}$ )	-0.3V to +4V
LVC MOS input voltage (TTL IN)	-0.3V to +3.6V
LVDS output voltage ( $OUT_{\pm}$ )	-0.3V to +3.9V
LVDS output short circuit current	24mA
Maximum Package Power Dissipation @ +25°C	
DBV Package	902 mW
Derate DBV Package	7.22 mW/°C above +25°C
Thermal Resistance ( $\theta_{JA}$ )	138.5°C/Watt
Storage Temperature	-65°C to +150°C
Lead Temperature – Soldering	+260°C (4 sec.)
Maximum Junction Temperature	+150°C
ESD Ratings	
HBM (1.5 k $\Omega$ , 100 pF)	≥ 9kV
EIAJ (0 $\Omega$ , 200 pF)	≥ 900V
CDM (0 $\Omega$ , 0 pF)	≥ 2000V
IEC direct (330 $\Omega$ , 150 pF)	≥ 4kV

(1) “Absolute Maximum Ratings” are those values beyond which the safety of the device cannot be specified. They are not meant to imply that the devices should be operated at these limits. [Electrical Characteristics](#) specifies conditions of device operation.

**Recommended Operating Conditions**

	Min	Typ	Max	Units
Supply Voltage ( $V_{DD}$ )	3.0	3.3	3.6	V
Temperature ( $T_A$ )	-40	+25	+85	°C

## Electrical Characteristics

 Over Supply Voltage and Operating Temperature ranges, unless otherwise specified. <sup>(1)(2)(3)</sup>

Symbol	Parameter	Conditions		Pin	Min	Typ	Max	Units
$ V_{OD} $	Output Differential Voltage	$R_L = 100\Omega$ (Figure 2 and Figure 3)		OUT+, OUT-	250	350	450	mV
$\Delta V_{OD}$	$V_{OD}$ Magnitude Change					3	35	mV
$V_{OS}$	Offset Voltage	$R_L = 100\Omega$ (Figure 2)			1.125	1.22	1.375	V
$\Delta V_{OS}$	Offset Magnitude Change				0	1	25	mV
$I_{OFF}$	Power-off Leakage	$V_{OUT} = 3.6V$ or GND, $V_{DD} = 0V$				$\pm 1$	$\pm 10$	$\mu A$
$I_{OS}$	Output Short Circuit Current <sup>(4)</sup>	$V_{OUT+}$ and $V_{OUT-} = 0V$				-6	-24	mA
$I_{OSD}$	Differential Output Short Circuit Current <sup>(4)</sup>	$V_{OD} = 0V$				-5	-12	mA
$C_{OUT}$	Output Capacitance					3		pF
$V_{IH}$	Input High Voltage			TTL IN	2.0		$V_{DD}$	V
$V_{IL}$	Input Low Voltage				GND		0.8	V
$I_{IH}$	Input High Current	$V_{IN} = 3.3V$ or 2.4V				$\pm 2$	$\pm 10$	$\mu A$
$I_{IL}$	Input Low Current	$V_{IN} = GND$ or 0.5V				$\pm 1$	$\pm 10$	$\mu A$
$V_{CL}$	Input Clamp Voltage	$I_{CL} = -18$ mA			-1.5	-0.6		V
$C_{IN}$	Input Capacitance					3		pF
$I_{DD}$	Power Supply Current	No Load	$V_{IN} = V_{DD}$ or GND	$V_{DD}$		5	8	mA
		$R_L = 100\Omega$				7	10	mA

- (1) Current into device pins is defined as positive. Current out of device pins is defined as negative. All voltages are referenced to ground except  $V_{OD}$ .
- (2) All typicals are given for:  $V_{DD} = +3.3V$  and  $T_A = +25^\circ C$ .
- (3) The DS90LV011A is a current mode device and only function with datasheet specification when a resistive load is applied to the drivers outputs.
- (4) Output short circuit current ( $I_{OS}$ ) is specified as magnitude only, minus sign indicates direction only.

## Switching Characteristics

 Over Supply Voltage and Operating Temperature Ranges, unless otherwise specified. <sup>(1)(2)(3)(4)</sup>

Symbol	Parameter	Conditions	Min	Typ	Max	Units
$t_{PHLD}$	Differential Propagation Delay High to Low	$R_L = 100\Omega$ , $C_L = 15$ pF (Figure 4 and Figure 5)	0.3	1.0	1.5	ns
$t_{PLHD}$	Differential Propagation Delay Low to High		0.3	1.1	1.5	ns
$t_{SKD1}$	Differential Pulse Skew $ t_{PHLD} - t_{PLHD} $ <sup>(5)</sup>		0	0.1	0.7	ns
$t_{SKD3}$	Differential Part to Part Skew <sup>(6)</sup>		0	0.2	1.0	ns
$t_{SKD4}$	Differential Part to Part Skew <sup>(7)</sup>		0	0.4	1.2	ns
$t_{TLH}$	Transition Low to High Time		0.2	0.5	1.0	ns
$t_{THL}$	Transition High to Low Time		0.2	0.5	1.0	ns
$f_{MAX}$	Maximum Operating Frequency <sup>(8)</sup>		200	250		MHz

- (1) All typicals are given for:  $V_{DD} = +3.3V$  and  $T_A = +25^\circ C$ .
- (2) These parameters are specified by design. The limits are based on statistical analysis of the device performance over PVT (process, voltage, temperature) ranges.
- (3)  $C_L$  includes probe and fixture capacitance.
- (4) Generator waveform for all tests unless otherwise specified:  $f = 1$  MHz,  $Z_O = 50\Omega$ ,  $t_r \leq 1$  ns,  $t_f \leq 1$  ns (10%-90%).
- (5)  $t_{SKD1}$ ,  $|t_{PHLD} - t_{PLHD}|$ , is the magnitude difference in differential propagation delay time between the positive going edge and the negative going edge of the same channel.
- (6)  $t_{SKD3}$ , Differential Part to Part Skew, is defined as the difference between the minimum and maximum specified differential propagation delays. This specification applies to devices at the same  $V_{DD}$  and within  $5^\circ C$  of each other within the operating temperature range.
- (7)  $t_{SKD4}$ , part to part skew, is the differential channel to channel skew of any event between devices. This specification applies to devices over recommended operating temperature and voltage ranges, and across process distribution.  $t_{SKD4}$  is defined as  $|Max - Min|$  differential propagation delay.
- (8)  $f_{MAX}$  generator input conditions:  $t_r = t_f < 1$  ns (0% to 100%), 50% duty cycle, 0V to 3V. Output criteria: duty cycle = 45%/55%,  $V_{OD} > 250mV$ . The parameter is specified by design. The limit is based on the statistical analysis of the device over the PVT range by the transitions times ( $t_{TLH}$  and  $t_{THL}$ ).

PARAMETER MEASUREMENT INFORMATION

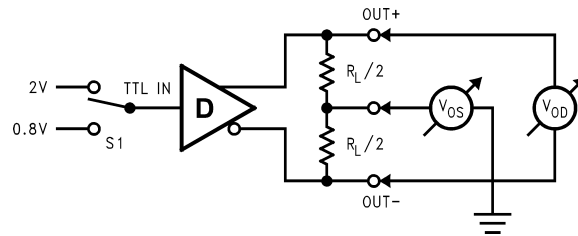

Figure 2. Differential Driver DC Test Circuit

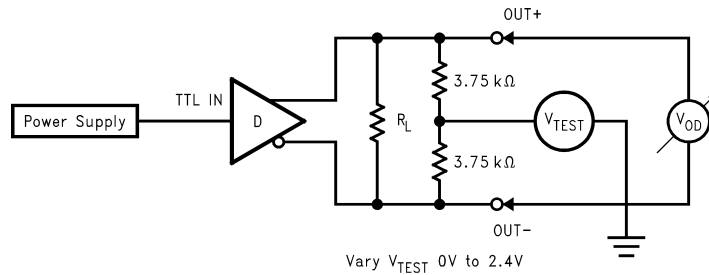

Figure 3. Differential Driver Full Load DC Test Circuit

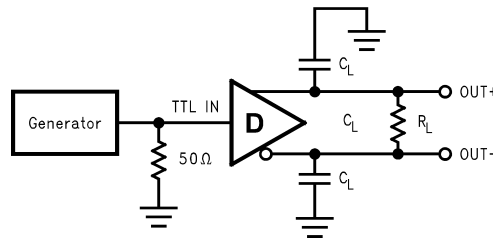

Figure 4. Differential Driver Propagation Delay and Transition Time Test Circuit

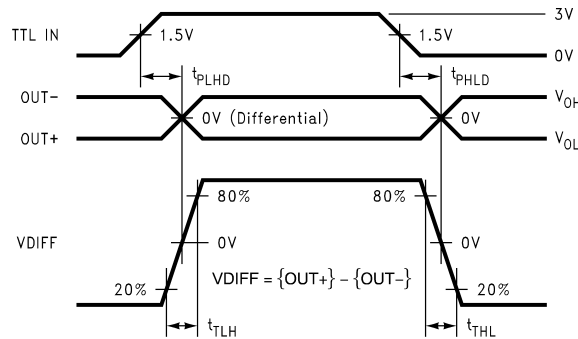

Figure 5. Differential Driver Propagation Delay and Transition Time Waveforms

## APPLICATION INFORMATION

**Table 1. Device Pin Descriptions**

Package Pin Number	Pin Name	Description
<b>SOT-23</b>		
5	TTL IN	LVTTTL/LVCMOS driver input pins
4	OUT+	Non-inverting driver output pin
3	OUT-	Inverting driver output pin
2	GND	Ground pin
1	V <sub>DD</sub>	Power supply pin, +3.3V ± 0.3V

## REVISION HISTORY

Changes from Revision B (April 2013) to Revision C	Page
• Changed layout of National Data Sheet to TI format .....	<a href="#">5</a>

**PACKAGING INFORMATION**

Orderable Device	Status (1)	Package Type	Package Drawing	Pins	Package Qty	Eco Plan (2)	Lead finish/ Ball material (6)	MSL Peak Temp (3)	Op Temp (°C)	Device Marking (4/5)	Samples
DS90LV011ATMF	NRND	SOT-23	DBV	5	1000	Non-RoHS & Green	Call TI	Level-1-260C-UNLIM	-40 to 85	N01	
DS90LV011ATMF/NOPB	ACTIVE	SOT-23	DBV	5	1000	RoHS & Green	SN	Level-1-260C-UNLIM	-40 to 85	N01	Samples
DS90LV011ATMFX/NOPB	ACTIVE	SOT-23	DBV	5	3000	RoHS & Green	SN	Level-1-260C-UNLIM	-40 to 85	N01	Samples

(1) The marketing status values are defined as follows:

**ACTIVE:** Product device recommended for new designs.

**LIFEBUY:** TI has announced that the device will be discontinued, and a lifetime-buy period is in effect.

**NRND:** Not recommended for new designs. Device is in production to support existing customers, but TI does not recommend using this part in a new design.

**PREVIEW:** Device has been announced but is not in production. Samples may or may not be available.

**OBSOLETE:** TI has discontinued the production of the device.

(2) **RoHS:** TI defines "RoHS" to mean semiconductor products that are compliant with the current EU RoHS requirements for all 10 RoHS substances, including the requirement that RoHS substance do not exceed 0.1% by weight in homogeneous materials. Where designed to be soldered at high temperatures, "RoHS" products are suitable for use in specified lead-free processes. TI may reference these types of products as "Pb-Free".

**RoHS Exempt:** TI defines "RoHS Exempt" to mean products that contain lead but are compliant with EU RoHS pursuant to a specific EU RoHS exemption.

**Green:** TI defines "Green" to mean the content of Chlorine (Cl) and Bromine (Br) based flame retardants meet JS709B low halogen requirements of <=1000ppm threshold. Antimony trioxide based flame retardants must also meet the <=1000ppm threshold requirement.

(3) MSL, Peak Temp. - The Moisture Sensitivity Level rating according to the JEDEC industry standard classifications, and peak solder temperature.

(4) There may be additional marking, which relates to the logo, the lot trace code information, or the environmental category on the device.

(5) Multiple Device Markings will be inside parentheses. Only one Device Marking contained in parentheses and separated by a "~" will appear on a device. If a line is indented then it is a continuation of the previous line and the two combined represent the entire Device Marking for that device.

(6) Lead finish/Ball material - Orderable Devices may have multiple material finish options. Finish options are separated by a vertical ruled line. Lead finish/Ball material values may wrap to two lines if the finish value exceeds the maximum column width.

**Important Information and Disclaimer:**The information provided on this page represents TI's knowledge and belief as of the date that it is provided. TI bases its knowledge and belief on information provided by third parties, and makes no representation or warranty as to the accuracy of such information. Efforts are underway to better integrate information from third parties. TI has taken and continues to take reasonable steps to provide representative and accurate information but may not have conducted destructive testing or chemical analysis on incoming materials and chemicals. TI and TI suppliers consider certain information to be proprietary, and thus CAS numbers and other limited information may not be available for release.

In no event shall TI's liability arising out of such information exceed the total purchase price of the TI part(s) at issue in this document sold by TI to Customer on an annual basis.



## TAPE AND REEL INFORMATION



### QUADRANT ASSIGNMENTS FOR PIN 1 ORIENTATION IN TAPE



\*All dimensions are nominal

Device	Package Type	Package Drawing	Pins	SPQ	Reel Diameter (mm)	Reel Width W1 (mm)	A0 (mm)	B0 (mm)	K0 (mm)	P1 (mm)	W (mm)	Pin1 Quadrant
DS90LV011ATMF	SOT-23	DBV	5	1000	178.0	8.4	3.2	3.2	1.4	4.0	8.0	Q3
DS90LV011ATMF/NOPB	SOT-23	DBV	5	1000	178.0	8.4	3.2	3.2	1.4	4.0	8.0	Q3
DS90LV011ATMFX/NOPB	SOT-23	DBV	5	3000	178.0	8.4	3.2	3.2	1.4	4.0	8.0	Q3

**TAPE AND REEL BOX DIMENSIONS**

\*All dimensions are nominal

Device	Package Type	Package Drawing	Pins	SPQ	Length (mm)	Width (mm)	Height (mm)
DS90LV011ATMF	SOT-23	DBV	5	1000	210.0	185.0	35.0
DS90LV011ATMF/NOPB	SOT-23	DBV	5	1000	210.0	185.0	35.0
DS90LV011ATMFX/NOPB	SOT-23	DBV	5	3000	210.0	185.0	35.0



# EXAMPLE BOARD LAYOUT

DBV0005A

SOT-23 - 1.45 mm max height

SMALL OUTLINE TRANSISTOR

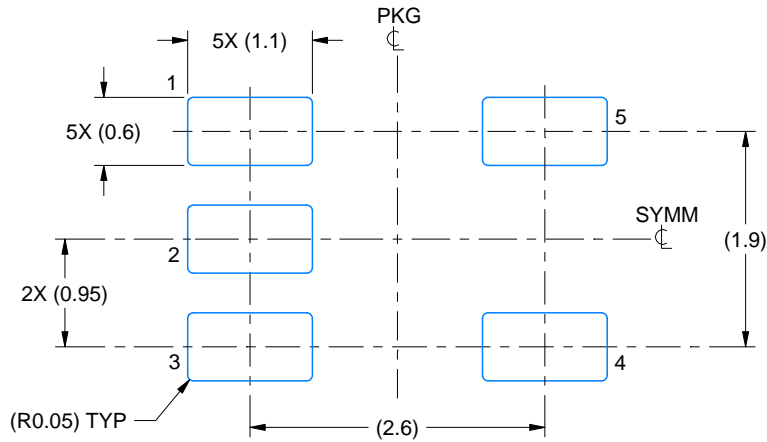

LAND PATTERN EXAMPLE  
EXPOSED METAL SHOWN  
SCALE:15X

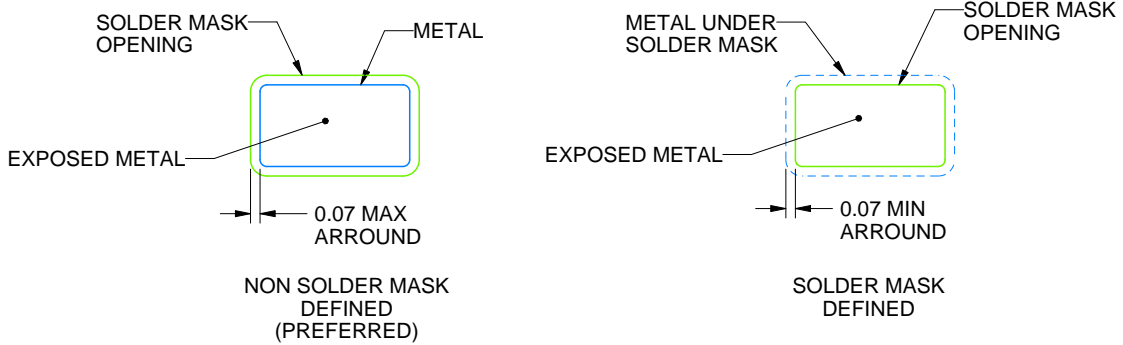

SOLDER MASK DETAILS

4214839/G 03/2023

NOTES: (continued)

- 6. Publication IPC-7351 may have alternate designs.
- 7. Solder mask tolerances between and around signal pads can vary based on board fabrication site.

# EXAMPLE STENCIL DESIGN

DBV0005A

SOT-23 - 1.45 mm max height

SMALL OUTLINE TRANSISTOR

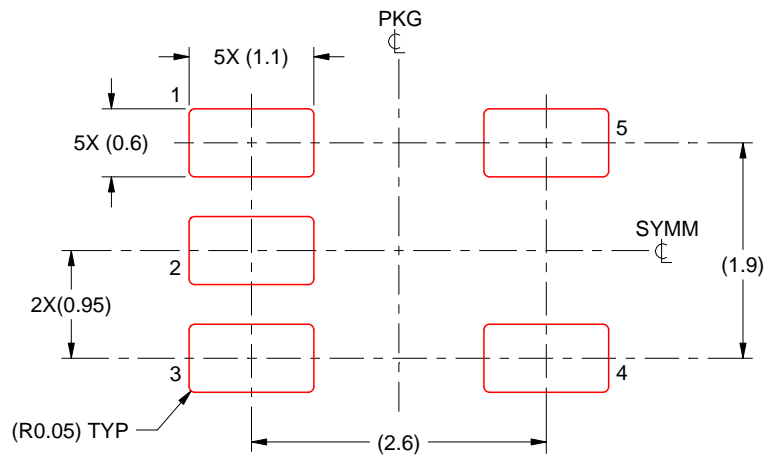

SOLDER PASTE EXAMPLE  
BASED ON 0.125 mm THICK STENCIL  
SCALE:15X

4214839/G 03/2023

NOTES: (continued)

8. Laser cutting apertures with trapezoidal walls and rounded corners may offer better paste release. IPC-7525 may have alternate design recommendations.
9. Board assembly site may have different recommendations for stencil design.

## IMPORTANT NOTICE AND DISCLAIMER

TI PROVIDES TECHNICAL AND RELIABILITY DATA (INCLUDING DATA SHEETS), DESIGN RESOURCES (INCLUDING REFERENCE DESIGNS), APPLICATION OR OTHER DESIGN ADVICE, WEB TOOLS, SAFETY INFORMATION, AND OTHER RESOURCES "AS IS" AND WITH ALL FAULTS, AND DISCLAIMS ALL WARRANTIES, EXPRESS AND IMPLIED, INCLUDING WITHOUT LIMITATION ANY IMPLIED WARRANTIES OF MERCHANTABILITY, FITNESS FOR A PARTICULAR PURPOSE OR NON-INFRINGEMENT OF THIRD PARTY INTELLECTUAL PROPERTY RIGHTS.

These resources are intended for skilled developers designing with TI products. You are solely responsible for (1) selecting the appropriate TI products for your application, (2) designing, validating and testing your application, and (3) ensuring your application meets applicable standards, and any other safety, security, regulatory or other requirements.

These resources are subject to change without notice. TI grants you permission to use these resources only for development of an application that uses the TI products described in the resource. Other reproduction and display of these resources is prohibited. No license is granted to any other TI intellectual property right or to any third party intellectual property right. TI disclaims responsibility for, and you will fully indemnify TI and its representatives against, any claims, damages, costs, losses, and liabilities arising out of your use of these resources.

TI's products are provided subject to [TI's Terms of Sale](#) or other applicable terms available either on [ti.com](https://www.ti.com) or provided in conjunction with such TI products. TI's provision of these resources does not expand or otherwise alter TI's applicable warranties or warranty disclaimers for TI products.

TI objects to and rejects any additional or different terms you may have proposed.

Mailing Address: Texas Instruments, Post Office Box 655303, Dallas, Texas 75265  
Copyright © 2023, Texas Instruments Incorporated