

LM3508 Synchronous Magnetic Constant Current White LED Driver

Check for Samples: [LM3508](#)

FEATURES

- Drives 4 Series White LEDs with up to 30mA
- >80% Peak Efficiency
- Up to 100kHz PWM Brightness Control
- Accurate $\pm 5\%$ LED Current Regulation across V_{IN} range
- Internal Synchronous PFET (No Schottky Diode Required)
- True Shutdown Isolation
- Output Short-Circuit Protection
- 17.5V Over-Voltage Protection
- Internal Soft-Start Eliminates Inrush Current
- Wide Input Voltage Range: 2.7V to 5.5V
- 850kHz Fixed Frequency Operation
- Low Profile 9-Bump DSBGA Package (1.514mm x 1.514mm x 0.6mm)

DESCRIPTION

The LM3508 is a synchronous boost converter (no external Schottky diode required) that provides a constant current output. It is designed to drive up to 4 series white LEDs at 30mA from a single-cell Li-Ion battery. A single low power external resistor is used to set the maximum LED current. The LED current can be adjusted by applying a PWM signal of up to 100kHz to the DIM pin. Internal soft-start circuitry is designed to eliminate high in-rush current at start-up. For maximum safety, the device features an advanced short-circuit protection when the output is shorted to ground. Additionally, over-voltage protection and an 850kHz switching frequency allow for the use of small, low-cost output capacitors with lower voltage ratings. During shutdown, the output is disconnected from the input preventing a leakage current path through the LEDs to ground. The LM3508 is available in a tiny 9-bump chip-scale DSBGA package.

APPLICATIONS

- White LED Backlighting
- Handheld Devices
- Digital Cameras
- Portable Applications

Typical Application Circuit

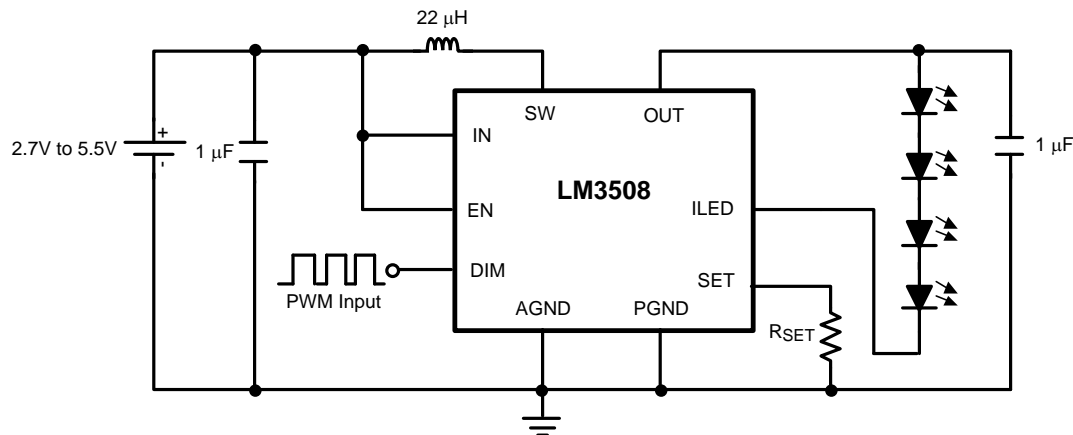

Please be aware that an important notice concerning availability, standard warranty, and use in critical applications of Texas Instruments semiconductor products and disclaimers thereto appears at the end of this data sheet.

All trademarks are the property of their respective owners.

Connection Diagram

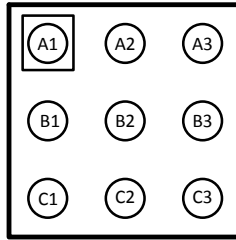

9-Bump (Large) DSBGA
(1.514mm x 1.514mm x 0.6mm) Package Number YZR000911A
Top View

PIN DESCRIPTIONS

Pin	Name	Function
A1	PGND	Power Ground Connection.
A2	SW	Inductor connection and drain connection for both NMOS and PMOS power devices.
A3	OUT	Output capacitor connection, PMOS source connection for synchronous rectifier, and OVP sensing node.
B1	ILED	Regulated current source input.
B2	DIM	Current source modulation input. A logic low at DIM turns off the internal current source. A logic high turns the LEDs fully on ($V_{SET}=200mV$). Apply a PWM signal at DIM for LED brightness control.
B3	IN	Input voltage connection.
C1	SET	Current sense connection and current source output. Connect a 1% resistor (R_{SET}) from SET to PGND to set the maximum LED current ($I_{LED} = 200mV/R_{SET}$).
C2	EN	Enable input. A logic low at EN turns off the LM3508. A logic high turns the device on.
C3	AGND	Analog ground. Connect AGND to PGND through a low impedance connection.



These devices have limited built-in ESD protection. The leads should be shorted together or the device placed in conductive foam during storage or handling to prevent electrostatic damage to the MOS gates.

ABSOLUTE MAXIMUM RATINGS⁽¹⁾⁽²⁾⁽³⁾

V _{IN}	-0.3V to 6V
V _{OUT}	-0.3V to 22V
V _{SW}	-0.3V to 22V
V _{ILED} , V _{SET} , V _{DIM} , V _{EN}	-0.3V to 6V
Continuous Power Dissipation	Internally Limited
Junction Temperature	+150°C
Lead Temperature ⁽⁴⁾	+300°C
Storage Temperature Range	-65°C to +150°C
ESD Rating ⁽⁵⁾ Human Body Model	2kV

- (1) Absolute maximum ratings are limits beyond which damage to the device may occur. Operating Ratings are conditions for which the device is intended to be functional, but device parameter may not be specified. For specifications and test conditions, see the Electrical Characteristics.
- (2) All voltages are with respect to PGND.
- (3) If Military/Aerospace specified devices are required, please contact the TI Sales Office/Distributors for availability and specifications.
- (4) For more detailed soldering information and specifications, please refer to Texas Instruments' Application Note AN-1112: DSBGA Wafer Level Chip Scale Package (Literature Number [SNVA009](#)).
- (5) The human body model is a 100pF capacitor discharged through 1.5kΩ resistor into each pin. (MIL-STD-883 3015.7).

OPERATING CONDITIONS⁽¹⁾⁽²⁾

Input Voltage Range	2.7V to 5.5V
Ambient Temperature Range ⁽³⁾	-30°C to +85°C
Junction Temperature Range	-30°C to +105°C

- (1) Absolute maximum ratings are limits beyond which damage to the device may occur. Operating Ratings are conditions for which the device is intended to be functional, but device parameters may not be specified. For specifications and test conditions, see the Electrical Characteristics.
- (2) All voltages are with respect to PGND.
- (3) In applications where high power dissipation and/or poor package thermal resistance is present, the maximum ambient temperature may have to be derated. Maximum ambient temperature (T_{A-MAX}) is dependent on the maximum operating junction temperature (T_{J-MAX-OP} = +125°C), the maximum power dissipation of the device in the application (P_{D-MAX}), and the junction-to ambient thermal resistance of the part/package in the application (θ_{JA}), as given by the following equation: T_{A-MAX} = T_{J-MAX-OP} – (θ_{JA} × P_{D-MAX}).

THERMAL PROPERTIES

Junction to Ambient Thermal Resistance (θ _{JA}) ⁽¹⁾	64.7°C/W
--	----------

- (1) Junction-to-ambient thermal resistance (θ_{JA}) is taken from thermal modeling performed under the conditions and guidelines set forth in the JEDEC standard JESD51-7. The test board is a 4-layer FR-4 board measuring (102mm × 76mm × 1.6mm) with a 2 × 1 array of thermal vias. The ground plane on the board is (50mm × 50mm). Thickness of copper layers are (36μm/18μm/18μm/36μm) (1.5oz/1oz/1oz/1.5oz copper). Ambient temperature in simulation is +22°C, still air. Power dissipation is 1W.

ELECTRICAL CHARACTERISTICS

Specifications in standard type face are for $T_A = 25^\circ\text{C}$ and those in **boldface type** apply over the Operating Temperature Range of $T_A = -30^\circ\text{C}$ to $+85^\circ\text{C}$. Unless otherwise specified $V_{IN} = 3.6\text{V}$.⁽¹⁾

Symbol	Parameter	Conditions	Min	Typ	Max	Units
I_D	LED Current Regulation	$R_{SET} = 10\Omega$		20		mA
		$R_{SET} = 6.67\Omega$		30		
V_{SET}	Voltage at SET Pin	$3.0\text{V} < V_{IN} < 5.5\text{V}$	190	200	210	mV
V_{ILED}	Voltage at ILED Pin			500		mV
V_{HR}	Current Sink Headroom Voltage	Where $I_{LED} = 95\%$ of nominal, $R_{SET} = 20\Omega$		400		mV
R_{DSON}	NMOS Switch On Resistance	$I_{SW} = 100\text{mA}$		0.5		Ω
	PMOS Switch On Resistance	$V_{OUT} = 10\text{V}$, $I_{SW} = 65\text{mA}$		2.2		
I_{CL}	NMOS Switch Current Limit		370	500	620	mA
I_{LSW}	SW Leakage Current	$V_{SW} = V_{IN} = 5.5\text{V}$, OUT Floating, $V_{EN} = \text{PGND}$		0.01		μA
$I_{OUT_SHUTDOWN}$	Output Pull-Down Resistance in Shutdown	$V_{EN} = 0\text{V}$		630		Ω
V_{OVP}	Output Over-Voltage Protection	ON Threshold (V_{OUT} rising)	17.5	19.8	21.8	V
		OFF Threshold (V_{OUT} falling)		18.6		
f_{SW}	Switching Frequency	$3.0\text{V} < V_{IN} < 5.5\text{V}$	715	850	1150	kHz
D_{MAX}	Maximum Duty Cycle			91		%
V_{SC}	Output Voltage Threshold for Short Circuit Detection	V_{OUT} Falling		$0.93 \times V_{IN}$		V
		V_{OUT} Rising		$0.95 \times V_{IN}$		
V_{EN_TH}	EN Threshold Voltage	On Threshold	1.1			V
		Off Threshold			0.5	
V_{DIM_TH}	DIM Threshold Voltage	On Threshold	1.1			V
		Off Threshold			0.5	
I_{DIM}	DIM Bias Current ⁽²⁾	$V_{DIM} = 1.8\text{V}$		4.7		μA
I_{EN}	EN Bias Current ⁽²⁾	$V_{EN} = 1.8\text{V}$		4.7		μA
I_{OUT}	OUT Bias Current	$V_{OUT} = 16\text{V}$, device not switching		420		μA
$R_{OUT_SHUTDOWN}$	Output Pull-Down Resistance in Shutdown	$V_{EN} = 0\text{V}$, $V_{OUT} < V_{IN}$		630		Ω
I_Q	Quiescent Current Device Not Switching	$V_{ILED} > 0.5\text{V}$, $3.0\text{V} < V_{IN} < 5.5\text{V}$, SW Floating		0.18	0.3	mA
		$V_{EN} = 0\text{V}$, $3.0\text{V} < V_{IN} < 5.5\text{V}$		0.01	0.5	
I_{Q_SW}	Switching Supply Current			825		μA
t_{START_UP}	From EN Low to High to Inductor Current Steady State	$V_{OUT} = 17\text{V}$, $I_{LED} = 20\text{mA}$		470		μs

(1) Min and Max limits are specified by design, test, or statistical analysis. Typical numbers are not specified, but do represent the most likely norm. Unless otherwise specified, conditions for typical specifications are $V_{IN} = 3.6\text{V}$, $T_A = +25^\circ\text{C}$.

(2) There is a typical $383\text{k}\Omega$ pull-down on this pin.

TYPICAL PERFORMANCE CHARACTERISTICS

$V_{IN} = 3.6V$, $R_{SET} = 10\Omega$, $L = \text{TDK VLF3012AT-220MR33}$ (22 μH), LEDs are OSRAM (LW M67C), $C_{OUT} = C_{IN} = 1\mu\text{F}$, $T_A = +25^\circ\text{C}$, unless otherwise noted.

4 LED Efficiency vs I_{LED}
($L = \text{TDK VLF3012AT-220MR33}$, $R_L = 0.66\Omega$)

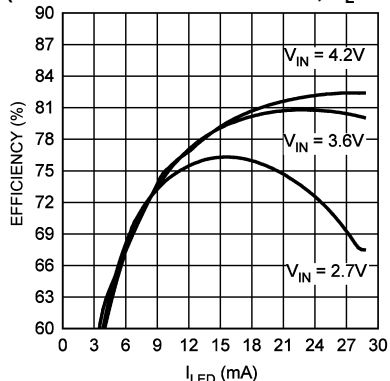

Figure 1.

3 LED Efficiency vs I_{LED}
($L = \text{TDK VLF3012AT-220MR33}$, $R_L = 0.66\Omega$)

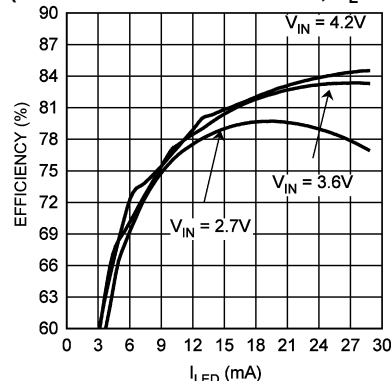

Figure 2.

2 LED Efficiency vs I_{LED}
($L = \text{TDK VLF3012AT-220MR33}$, $R_L = 0.66\Omega$)

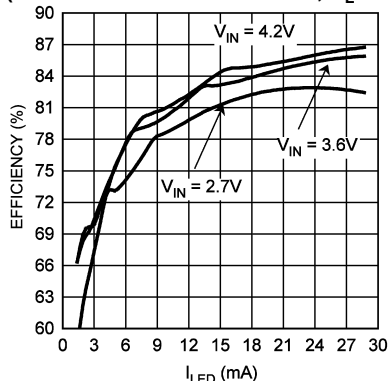

Figure 3.

Converter Output Voltage vs LED Current

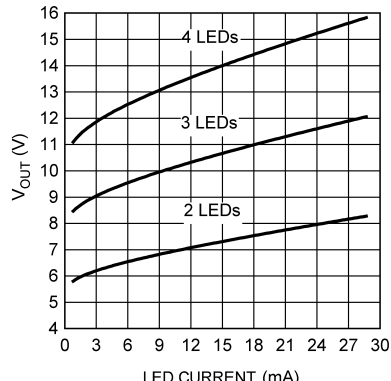

Figure 4.

Efficiency vs V_{IN} ($I_{LED} = 20\text{mA}$)

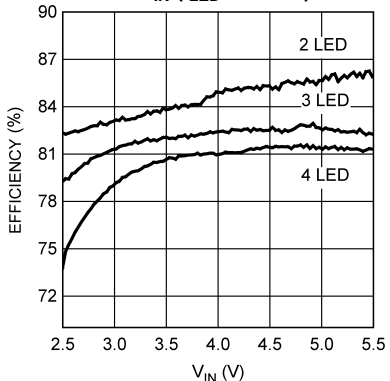

Figure 5.

Efficiency vs V_{IN} ($I_{LED} = 30\text{mA}$)

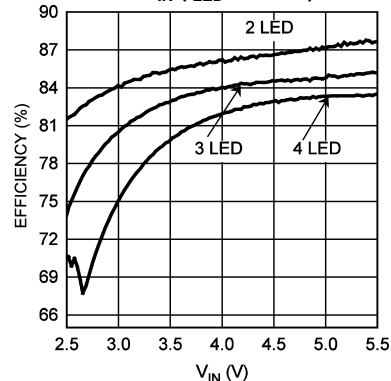

Figure 6.

TYPICAL PERFORMANCE CHARACTERISTICS (continued)

$V_{IN} = 3.6V$, $R_{SET} = 10\Omega$, $L = \text{TDK VLF3012AT-220MR33}$ ($22\mu H$), LEDs are OSRAM (LW M67C), $C_{OUT} = C_{IN} = 1\mu F$, $T_A = +25^\circ C$, unless otherwise noted.

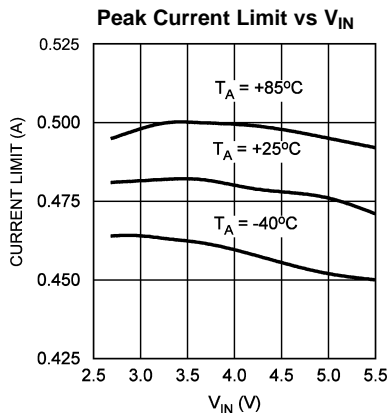

Figure 7.

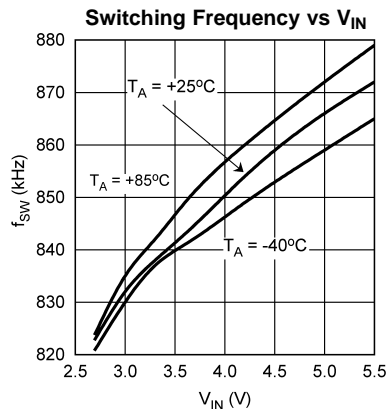

Figure 8.

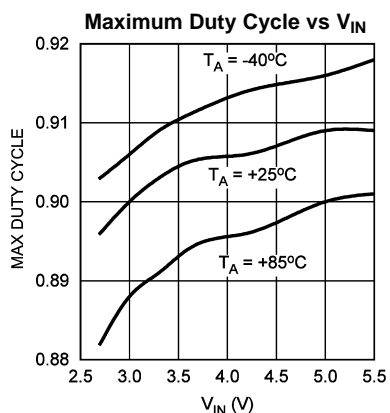

Figure 9.

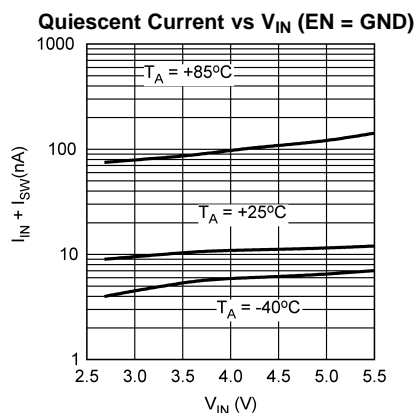

Figure 10.

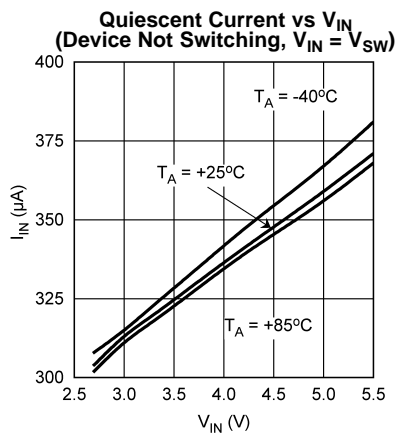

Figure 11.

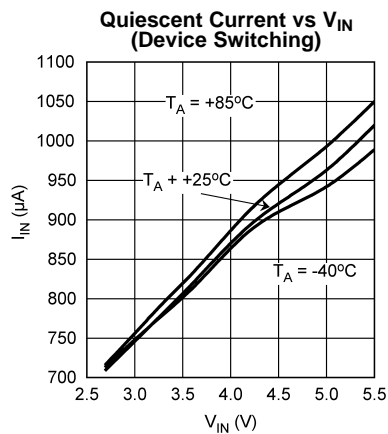

Figure 12.

TYPICAL PERFORMANCE CHARACTERISTICS (continued)

$V_{IN} = 3.6V$, $R_{SET} = 10\Omega$, $L = \text{TDK VLF3012AT-220MR33}$ ($22\mu H$), LEDs are OSRAM (LW M67C), $C_{OUT} = C_{IN} = 1\mu F$, $T_A = +25^\circ C$, unless otherwise noted.

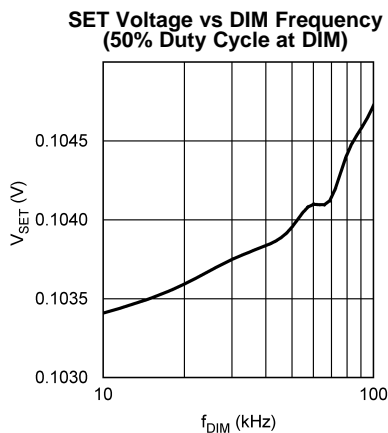

Figure 13.

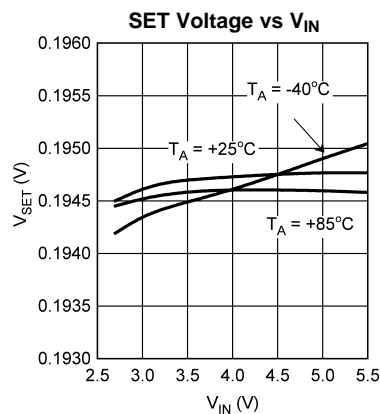

Figure 14.

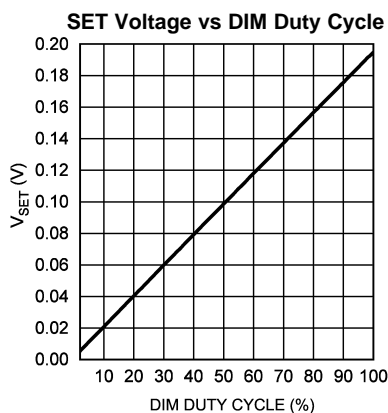

Figure 15.

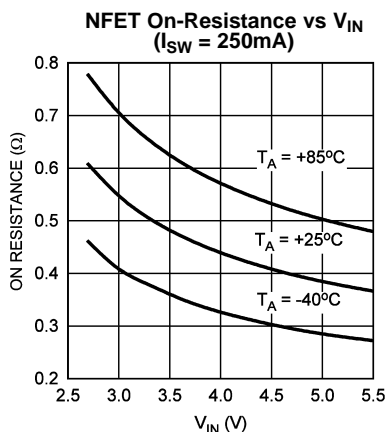

Figure 16.

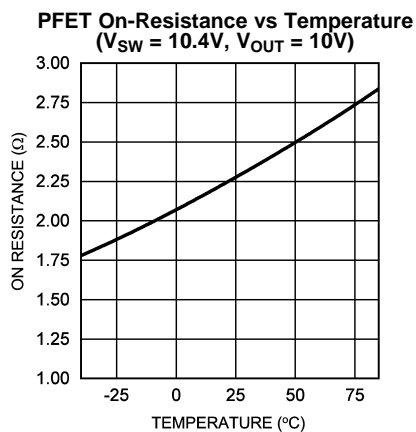

Figure 17.

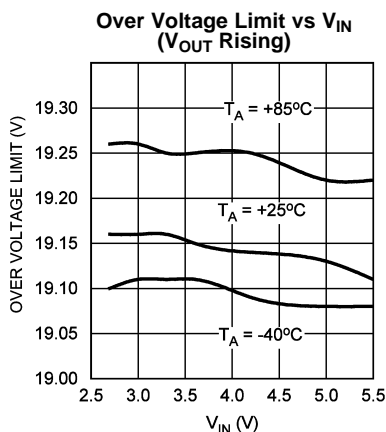

Figure 18.

TYPICAL PERFORMANCE CHARACTERISTICS (continued)

$V_{IN} = 3.6V$, $R_{SET} = 10\Omega$, $L =$ TDK VLF3012AT-220MR33 ($22\mu H$), LEDs are OSRAM (LW M67C), $C_{OUT} = C_{IN} = 1\mu F$, $T_A = +25^\circ C$, unless otherwise noted.

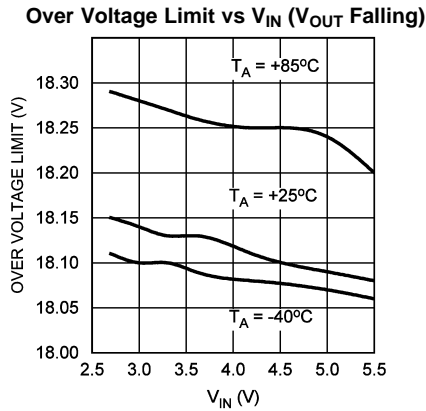
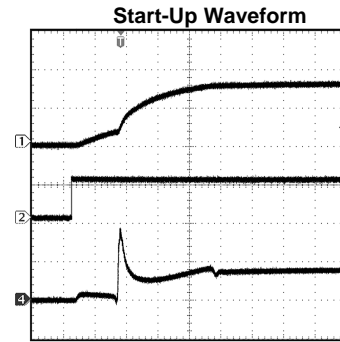
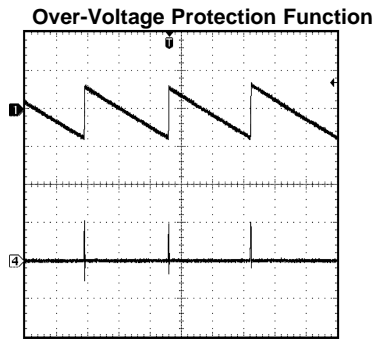

Figure 19.



4 LEDs, $I_{LED} = 30mA$, $V_{IN} = 3.6V$
 Channel 1: V_{OUT} (10V/div)
 Channel 2: EN (2V/div)
 Channel 4: I_{IN} (200mA/div)
 Time Base: 100 μs /div

Figure 20.



$V_{IN} = 3.6V$, $V_{OUT} = 18.86V$
 Channel 1: V_{OUT} (1V/div)
 Channel 4: I_{IN} (500mA/div)
 Time Base: 400 μs /div

Figure 21.

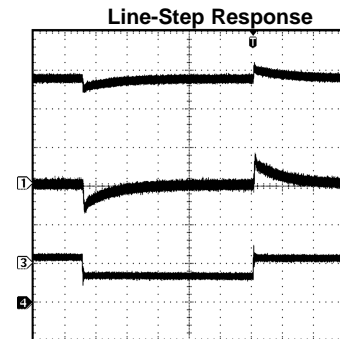

$V_{IN} = 3.6V$, 4 LEDs
 Channel 1: V_{OUT} (AC Coupled, 1V/div)
 Channel 3: V_{IN} (AC Coupled, 500mV/div)
 Channel 4: I_{LED} (DC Coupled, 5mA/div)
 Time Base: 200 μs /div

Figure 22.

TYPICAL PERFORMANCE CHARACTERISTICS (continued)

$V_{IN} = 3.6V$, $R_{SET} = 10\Omega$, $L =$ TDK VLF3012AT-220MR33 ($22\mu H$), LEDs are OSRAM (LW M67C), $C_{OUT} = C_{IN} = 1\mu F$, $T_A = +25^\circ C$, unless otherwise noted.

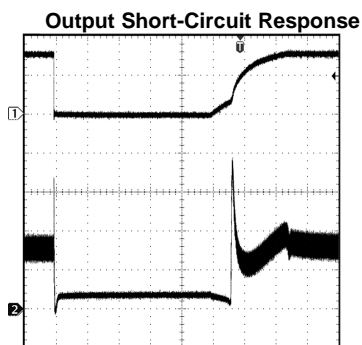

$V_{IN} = 3.6V$, $I_{LED} = 30mA$
Channel 1: V_{OUT} (10V/div)
Channel 2: I_{IN} (100mA/div)
Time Base: 200 μs /div

Figure 23.

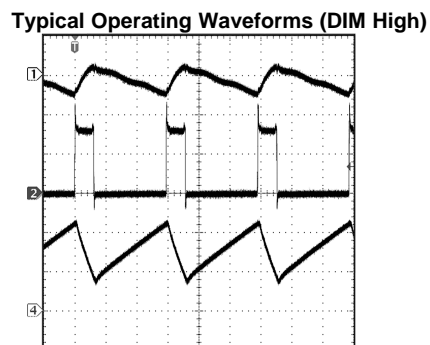

$V_{IN} = 3.6V$, 4 LEDs, $I_{LED} = 30mA$, $V_{OUT} = 15.8V$
Channel 1: V_{OUT} (AC Coupled, 100mV/div)
Channel 2: V_{SW} (DC Coupled, 10V/div)
Channel 4: I_L (DC Coupled, 100mA/div)
Time Base: 400ns/div

Figure 24.

Typical Operating Waveforms (DIM With 20kHz Square Wave)

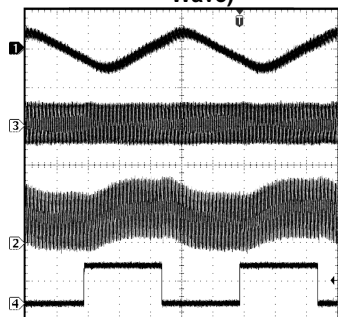

$V_{IN} = 3.6V$, 4 LEDs, $I_{LED} = 15mA$
Channel 1: V_{OUT} (AC Coupled, 200mV/div)
Channel 3: V_{IN} (AC Coupled, 100mV/div)
Channel 2: I_L (DC Coupled, 100mA/div)
Channel 4: DIM (DC Coupled, 2V/div)
Time Base: 10 μs /div

Figure 25.

DIM Operation (I_{LED} changing from 30mA to 15mA)

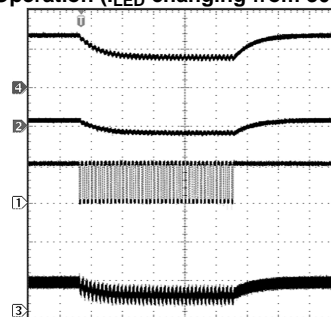

$V_{IN} = 3.6V$
Channel 4: I_{LED} (DC Coupled, 10mA/div)
Channel 2: V_{OUT} (AC Coupled, 2V/div)
Channel 1: DIM (DC Coupled, 2V/div, 20kHz, 50% duty cycle)
Channel 3: I_{IN} (DC Coupled, 200mA/div)
Time Base: 400 μs /div

Figure 26.

OPERATION

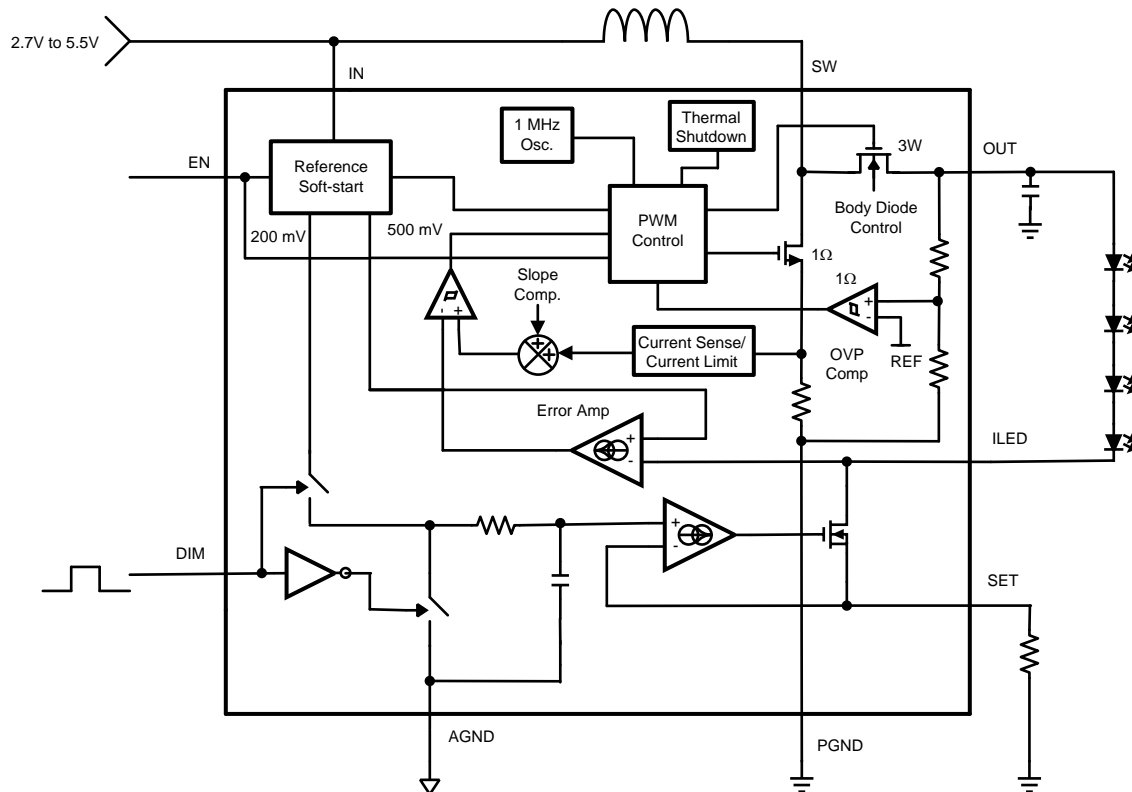

Figure 27. LM3508 Block Diagram

The LM3508 utilizes a synchronous step-up current mode PWM controller and a regulated current sink to provide a highly efficient and accurate LED current for white LED bias. The internal synchronous rectifier increases efficiency and eliminates the need for an external diode. Additionally, internal compensation eliminates the need for external compensation components resulting in a compact overall solution.

[Figure 27](#) shows the detailed block diagram of the LM3508. The output of the boost converter (OUT) provides power to the series string of white LED's connected between OUT and ILED. The boost converter regulates the voltage at ILED to 500mV. This voltage is then used to power the internal current source whose output is at SET.

The first stage of the LM3508 consists of the synchronous boost converter. Operation is as follows: At the start of each switching cycle the oscillator sets the PWM controller. The controller turns the low side (NMOS) switch on and the synchronous rectifier (PMOS) switch off. During this time current ramps up in the inductor while the output capacitor supplies the current to the LED's. The error signal at the output of the error amplifier is compared against the sensed inductor current. When the sensed inductor current equals the error signal, or when the maximum duty cycle is reached, the NMOS switch turns off and the PMOS switch turns on. When the PMOS turns on, the inductor current ramps down, restoring energy to the output capacitor and supplying current to the LED's. At the end of the clock period the PWM controller is again set and the process repeats itself. This action regulates ILED to 500mV.

The second stage of the LM3508 consists of an internal current source powered by the ILED voltage and providing a regulated current at SET. The regulated LED current is set by connecting an external resistor from SET to PGND. V_{SET} is adjusted from 0 to 200mV by applying a PWM signal of up to typically 100kHz at DIM (see [TYPICAL PERFORMANCE CHARACTERISTICS](#) of SET voltage vs DIM frequency). The PWM signal at DIM modulates the internal 200mV reference and applies it to an internal RC filter resulting in an adjustable SET voltage and thus an adjustable LED current.

Start-Up

The LM3508 features a soft-start to prevent large inrush currents during start-up that can cause excessive voltage ripple on VIN. During start-up the average input current is ramped up at a controlled rate. For the typical application circuit, driving 4LED's from a 3.6V lithium battery at 30mA, when EN is driven high the average input current ramps from zero to 160mA in 470µs. See plot of Soft Start functionality in the [TYPICAL PERFORMANCE CHARACTERISTICS](#).

DIM Operation

DIM is the input to the gate of an internal switch that accepts a logic level PWM waveform and modulates the internal 200mV reference through an internal RC filter. This forces the current source regulation point (V_{SET}) to vary by the duty cycle (D) of the DIM waveform making $I_{LED} = D \times 200\text{mV} / R_{SET}$. The cutoff frequency for the filter is approximately 500Hz. DIM frequencies higher than 100kHz cause the LED current to drastically deviate from their nominal set points. The graphs of SET voltage vs DIM frequency, SET voltage vs V_{IN} and SET voltage vs DIM duty cycle (see [TYPICAL PERFORMANCE CHARACTERISTICS](#)) show the typical variation of the current source set point voltage.

Enable Input and Output Isolation

Driving EN high turns the device on while driving EN low places the LM3508 in shutdown. In shutdown the supply current reduces to less than 1µA, the internal synchronous PFET turns off as well as the current source (N2 in [Figure 27](#)). This completely isolates the output from the input and prevents leakage current from flowing through the LED's. In shutdown the leakage current into SW and IN is typically 400nA. EN has an internal 383kΩ pull-down to PGND.

Peak Current Limit/Maximum Output Current

The LM3508 boost converter provides a peak current limit. When the peak inductor current reaches the peak current limit the duty cycle is terminated. This results in a limit on the maximum output power and thus the maximum output current the LM3508 can deliver. Calculate the maximum LED current as a function of V_{IN} , V_{OUT} , L and I_{PEAK} as:

$$I_{LED_MAX} = \frac{(I_{PEAK} - \Delta I_L) \times \eta \times V_{IN}}{V_{OUT}}$$

$$\text{where } \Delta I_L = \frac{V_{IN} \times (V_{OUT} - V_{IN})}{2 \times f_{SW} \times L \times V_{OUT}} \quad (1)$$

and $f_{SW} = 850\text{kHz}$. Efficiency and I_{PEAK} can be found in the efficiency and I_{PEAK} curves in the [TYPICAL PERFORMANCE CHARACTERISTICS](#).

Output Current Accuracy

The LM3508 provides highly accurate output current regulation of $\pm 5\%$ over the 3V to 5.5V input voltage range. Accuracy depends on various key factors. Among these are; the tolerance of R_{SET} , the frequency at DIM (f_{DIM}), and the errors internal to the LM3508 controller and current sink. For best accuracy, use a 1% resistor for R_{SET} and keep f_{DIM} between 1kHz and 100kHz. Refer to the [TYPICAL PERFORMANCE CHARACTERISTICS](#) for V_{SET} vs V_{IN} , V_{SET} vs f_{DIM} , and V_{SET} vs DIM duty cycle.

Voltage Head Room at ILED

If the LED current is increased to a point where the peak inductor current is reached, the boost converter's on-time is terminated until the next switching cycle. If the LED current is further increased the 500mV regulated voltage at ILED begins to drop. When V_{ILED} drops below the current sink headroom voltage ($V_{HR} = 400\text{mV typ.}$) the current sink FET (see N2 in [Figure 27](#)) will be fully on, appearing as a 5Ω resistor between ILED and SET.

Output Short Circuit Protection

The LM3508 provides a short circuit protection that limits the output current if OUT is shorted to PGND. During a short at OUT when V_{OUT} falls to below $V_{IN} \times 0.93$, switching will stop. The PMOS will turn into a current source and limit the output current to 35mA. The LM3508 can survive with a continuous short at the output. The threshold for OUT recovering from a short circuit condition is typically $V_{IN} \times 0.95$.

Output Over-Voltage Protection

When the load at the output of the LM3508 goes high impedance the boost converter will raise V_{OUT} to try and maintain the programmed LED current. To prevent over-voltage conditions that can damage output capacitors and/or the device, the LM3508 will clamp the output at a maximum of 21.8V. This allows for the use of 25V output capacitors available in a tiny 1.6mm \times 0.8mm case size.

During output open circuit conditions when the output voltage rises to the over voltage protection threshold ($V_{OVP} = 19.8V$ typical) the OVP circuitry will shut off both the NMOS and PMOS switches. When the output voltage drops below 18.6V (typically) the converter will begin switching again. If the device remains in an over voltage condition the cycle will be repeated resulting in a pulsed condition at the output. See waveform for OVP condition in the [TYPICAL PERFORMANCE CHARACTERISTICS](#).

Light Load Operation

During light load conditions when the inductor current reaches zero before the end of the switching period, the PFET will turn off, disconnecting OUT from SW and forcing the converter into discontinuous conduction. At the beginning of the next switching cycle, switching will resume. (see plot of discontinuous conduction mode in the [TYPICAL PERFORMANCE CHARACTERISTICS](#) graphs).

Boost converters that operate in the discontinuous conduction mode with fixed input to output conversion ratios (V_{OUT}/V_{IN}) have load dependent duty cycles, resulting in shorter switch on-times as the load decreases. As the load is decreased the duty cycle will fall until the converter hits its minimum duty cycle (typically 15%). To prevent further decreases in the load current altering the V_{OUT}/V_{IN} ratio, the LM3508 will enter a pulsed skip mode. In pulse skip mode the device will only switch as necessary to keep the LED current in regulation.

Thermal Shutdown

The LM3508 provides a thermal shutdown feature. When the die temperature exceeds +150°C the part will shutdown, turning off both the NMOS and PMOS FET's. The part will start-up again with a soft-start sequence when the die temperature falls below +115°C.

APPLICATION INFORMATION

Brightness Adjustment

A logic high at DIM forces SET to regulate to 200mV. Adjust the maximum LED current by picking R_{SET} (the resistor from SET to GND) such that:

$$I_{LED_MAX} = \frac{200 \text{ mV}}{R_{SET}} \quad (2)$$

Once I_{LED_MAX} is set, the LED current can be adjusted from I_{LED_MAX} down to I_{LED_MIN} by applying a logic level PWM signal to DIM. This results in:

$$I_{LED} = \frac{D \times 200 \text{ mV}}{R_{SET}} \quad (3)$$

where D is the duty cycle of the PWM pulse applied to DIM. The LM3508 can be brought out of shutdown while a signal is applied to DIM, allowing the device to turn on into a low LED current mode. A logic low at DIM will shut off the current source making I_{LED} high impedance however, the boost converter continues to operate. Due to an offset voltage at SET (approximately +/-2mV) the LED's can faintly illuminate even with DIM pulled to GND. If zero LED current is required then pulling EN low will shutdown the current source causing the LED current to drop to zero. DIM has an internal 383kΩ pull down to PGND.

Input Capacitor Selection

Choosing the correct size and type of input capacitor helps minimize the input voltage ripple caused by the switching action of the LM3508's boost converter. For continuous inductor current operation the input voltage ripple is composed of 2 primary components, the capacitor discharge (delta V_Q) and the capacitor's equivalent series resistance (delta V_{ESR}). The ripple due to strictly to the capacitor discharge is:

$$\Delta V_Q = \frac{\Delta I_L \times D}{2 \times f_{SW} \times C_{IN}} \quad (4)$$

The ripple due to strictly to the capacitors ESR is:

$$\Delta V_{ESR} = 2 \times I_L \times R_{ESR}$$

where
$$\Delta I_L = \frac{V_{IN} \times (V_{OUT} - V_{IN})}{2 \times f_{SW} \times L \times V_{OUT}} \quad (5)$$

In the typical application circuit, a 1μF ceramic input capacitor works well. Since the ESR in ceramic capacitors is typically less than 5mΩ and the capacitance value is usually small, the input voltage ripple is primarily due to the capacitive discharge. With larger value capacitors such as tantalum or aluminum electrolytic the ESR can be greater than 0.5Ω. In this case the input ripple will primarily be due to the ESR.

Output Capacitor Selection

In a boost converter such as the LM3508, during the on time, the inductor is disconnected from OUT forcing the output capacitor to supply the LED current. When the PMOS switch (synchronous rectifier) turns on the inductor energy supplies the LED current and restores charge to the output capacitor. This action causes a sag in the output voltage during the on time and a rise in the output voltage during the off time.

The LM3508's output capacitor is chosen to limit the output ripple to an acceptable level and to ensure the boost converter is stable. For proper operation use a 1μF ceramic output capacitor. Values of 2.2μF or 4.7μF can be used although start-up current and start-up time will be increased. As with the input capacitor, the output voltage ripple is composed of two parts, the ripple due to capacitor discharge (delta V_Q) and the ripple due to the capacitors ESR (delta V_{ESR}). Most of the time the LM3508 will operate in continuous conduction mode. In this mode the ripple due to capacitor discharge is given by:

$$\Delta V_Q = \frac{I_{LED} \times (V_{OUT} - V_{IN})}{f_{SW} \times V_{OUT} \times C_{OUT}} \quad (6)$$

The output voltage ripple component due to the output capacitors ESR is found by:

$$\Delta V_{ESR} = R_{ESR} \times \left(\frac{I_{LED} \times V_{IN}}{V_{IN}} + \Delta I_L \right)$$

where $\Delta I_L = \frac{V_{IN} \times (V_{OUT} - V_{IN})}{2 \times f_{SW} \times L \times V_{OUT}}$

(7)

Table 1. Recommended Output Capacitor Manufacturers

Manufacturer	Part Number	Value	Case Size	Voltage Rating
Murata	GRM39X5R105K25D539	1 μ F	0603	25V
TDK	C1608X5R1E105M	1 μ F	0603	25V

Inductor Selection

The LM3508 is designed to operate with 10 μ H to 22 μ H inductor's. When choosing the inductor ensure that the inductors saturation current rating is greater than

$$\frac{I_{LED}}{\eta} \times \frac{V_{OUT}}{V_{IN}} + \Delta I_L$$

where $\Delta I_L = \frac{V_{IN} \times (V_{OUT} - V_{IN})}{2 \times f_{SW} \times L \times V_{OUT}}$

(8)

Additionally, the inductor's value should be large enough such that at the maximum LED current, the peak inductor current is less than the LM3508's peak switch current limit. This is done by choosing L such that

$$L > \frac{V_{IN} \times (V_{OUT} - V_{IN})}{2 \times f_{SW} \times L \times V_{OUT} \times \left(I_{PEAK} - \frac{I_{LED_MAX} \times V_{OUT}}{\eta \times V_{IN}} \right)}$$
(9)

Values for I_{PEAK} and efficiency can be found in the plot of peak current limit vs. V_{IN} in the [TYPICAL PERFORMANCE CHARACTERISTICS](#) graphs.

Table 2. Recommended Inductor Manufacturers

Manufacturer	L	Part Number	Size	Saturation Current
TDK	22 μ H	VLF3010AT-220MR33	2.6mmx2.8mmx1mm	330mA
TDK	22 μ H	VLF3012AT-220MR33	2.6mmx2.8mmx1.2mm	330mA
Toko	22 μ H	D3313FB(1036FB-220M)	3.3mmx3.3mmx1.3mm	350mA

Layout Considerations



Proper layout is essential for stable, jitter free operation, and good efficiency. Follow these steps to ensure a good layout.

- 1, Use a separate ground plane for power ground (PGND) and analog ground (AGND).
- 2, Keep high current paths such as SW and PGND connections short.
- 3, Connect the return terminals for the input capacitor and the output capacitor together at a single point as close as possible to PGND.
- 4, Connect PGND and AGND together as close as possible to the IC. Do not connect them together anywhere else.
- 5, Connect the input capacitor (C_{IN}) as close as possible to IN.
- 6, Connect the output capacitor (C_{OUT}) as close as possible to OUT.
- 7, Connect the positive terminal of R_{SET} as close as possible to ILED and the negative terminal as close as possible to PGND. This ensures accurate current programming.

REVISION HISTORY

Changes from Revision B (May 2013) to Revision C	Page
• Changed layout of National Data Sheet to TI format	14

PACKAGING INFORMATION

Orderable Device	Status (1)	Package Type	Package Drawing	Pins	Package Qty	Eco Plan (2)	Lead finish/ Ball material (6)	MSL Peak Temp (3)	Op Temp (°C)	Device Marking (4/5)	Samples
LM3508TL/NOPB	ACTIVE	DSBGA	YZR	9	250	RoHS & Green	SNAGCU	Level-1-260C-UNLIM	-30 to 85	D 31	
LM3508TLX/NOPB	ACTIVE	DSBGA	YZR	9	3000	RoHS & Green	SNAGCU	Level-1-260C-UNLIM	-30 to 85	D 31	

(1) The marketing status values are defined as follows:

ACTIVE: Product device recommended for new designs.

LIFEBUY: TI has announced that the device will be discontinued, and a lifetime-buy period is in effect.

NRND: Not recommended for new designs. Device is in production to support existing customers, but TI does not recommend using this part in a new design.

PREVIEW: Device has been announced but is not in production. Samples may or may not be available.

OBSOLETE: TI has discontinued the production of the device.

(2) **RoHS:** TI defines "RoHS" to mean semiconductor products that are compliant with the current EU RoHS requirements for all 10 RoHS substances, including the requirement that RoHS substance do not exceed 0.1% by weight in homogeneous materials. Where designed to be soldered at high temperatures, "RoHS" products are suitable for use in specified lead-free processes. TI may reference these types of products as "Pb-Free".

RoHS Exempt: TI defines "RoHS Exempt" to mean products that contain lead but are compliant with EU RoHS pursuant to a specific EU RoHS exemption.

Green: TI defines "Green" to mean the content of Chlorine (Cl) and Bromine (Br) based flame retardants meet JS709B low halogen requirements of <=1000ppm threshold. Antimony trioxide based flame retardants must also meet the <=1000ppm threshold requirement.

(3) MSL, Peak Temp. - The Moisture Sensitivity Level rating according to the JEDEC industry standard classifications, and peak solder temperature.

(4) There may be additional marking, which relates to the logo, the lot trace code information, or the environmental category on the device.

(5) Multiple Device Markings will be inside parentheses. Only one Device Marking contained in parentheses and separated by a "~" will appear on a device. If a line is indented then it is a continuation of the previous line and the two combined represent the entire Device Marking for that device.

(6) Lead finish/Ball material - Orderable Devices may have multiple material finish options. Finish options are separated by a vertical ruled line. Lead finish/Ball material values may wrap to two lines if the finish value exceeds the maximum column width.

Important Information and Disclaimer:The information provided on this page represents TI's knowledge and belief as of the date that it is provided. TI bases its knowledge and belief on information provided by third parties, and makes no representation or warranty as to the accuracy of such information. Efforts are underway to better integrate information from third parties. TI has taken and continues to take reasonable steps to provide representative and accurate information but may not have conducted destructive testing or chemical analysis on incoming materials and chemicals. TI and TI suppliers consider certain information to be proprietary, and thus CAS numbers and other limited information may not be available for release.

In no event shall TI's liability arising out of such information exceed the total purchase price of the TI part(s) at issue in this document sold by TI to Customer on an annual basis.

TAPE AND REEL INFORMATION

QUADRANT ASSIGNMENTS FOR PIN 1 ORIENTATION IN TAPE

*All dimensions are nominal

Device	Package Type	Package Drawing	Pins	SPQ	Reel Diameter (mm)	Reel Width W1 (mm)	A0 (mm)	B0 (mm)	K0 (mm)	P1 (mm)	W (mm)	Pin1 Quadrant
LM3508TL/NOPB	DSBGA	YZR	9	250	178.0	8.4	1.7	1.7	0.76	4.0	8.0	Q1
LM3508TLX/NOPB	DSBGA	YZR	9	3000	178.0	8.4	1.7	1.7	0.76	4.0	8.0	Q1

TAPE AND REEL BOX DIMENSIONS

*All dimensions are nominal

Device	Package Type	Package Drawing	Pins	SPQ	Length (mm)	Width (mm)	Height (mm)
LM3508TL/NOPB	DSBGA	YZR	9	250	208.0	191.0	35.0
LM3508TLX/NOPB	DSBGA	YZR	9	3000	208.0	191.0	35.0

YZR0009

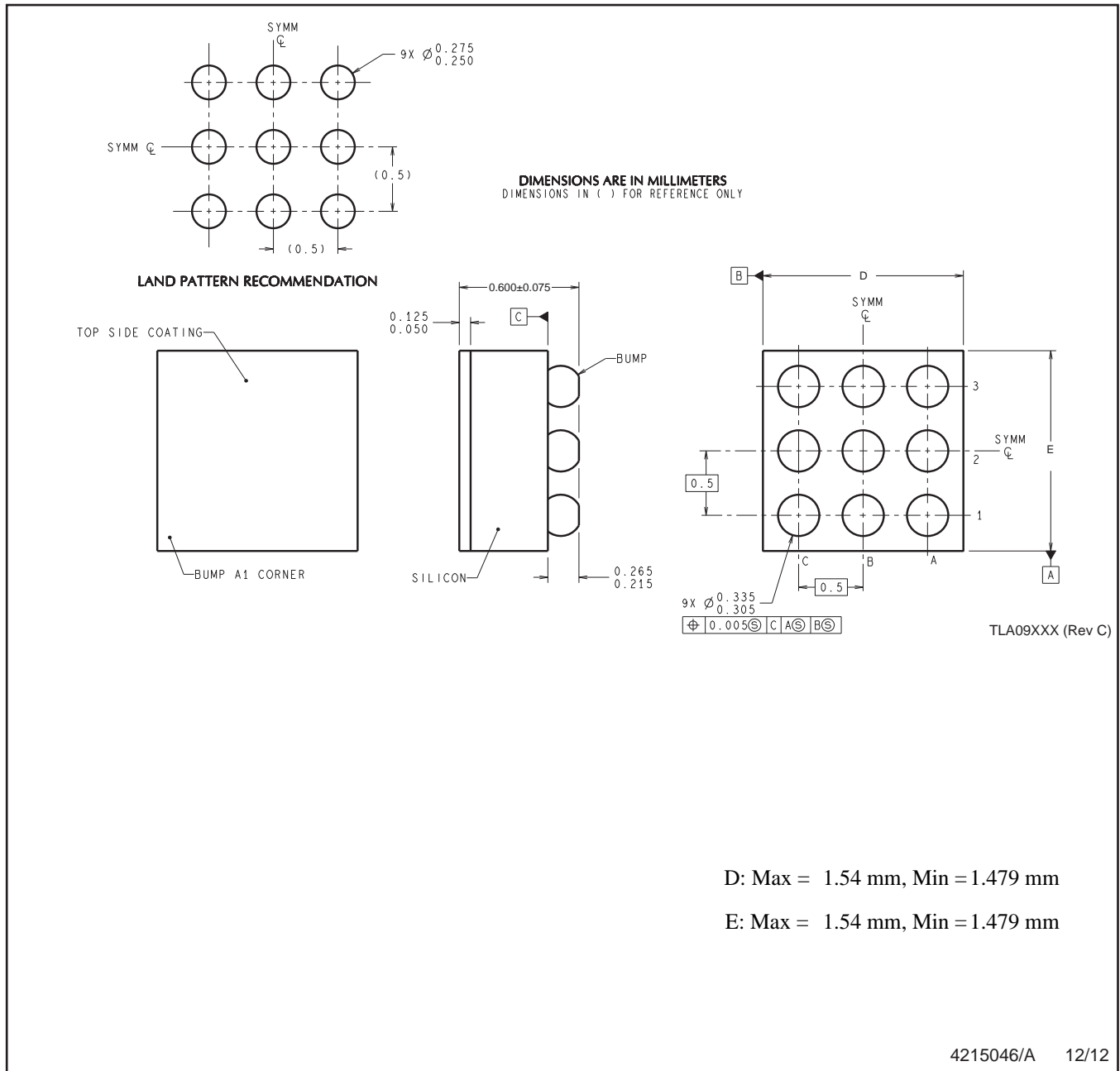

NOTES: A. All linear dimensions are in millimeters. Dimensioning and tolerancing per ASME Y14.5M-1994.
 B. This drawing is subject to change without notice.

IMPORTANT NOTICE AND DISCLAIMER

TI PROVIDES TECHNICAL AND RELIABILITY DATA (INCLUDING DATA SHEETS), DESIGN RESOURCES (INCLUDING REFERENCE DESIGNS), APPLICATION OR OTHER DESIGN ADVICE, WEB TOOLS, SAFETY INFORMATION, AND OTHER RESOURCES "AS IS" AND WITH ALL FAULTS, AND DISCLAIMS ALL WARRANTIES, EXPRESS AND IMPLIED, INCLUDING WITHOUT LIMITATION ANY IMPLIED WARRANTIES OF MERCHANTABILITY, FITNESS FOR A PARTICULAR PURPOSE OR NON-INFRINGEMENT OF THIRD PARTY INTELLECTUAL PROPERTY RIGHTS.

These resources are intended for skilled developers designing with TI products. You are solely responsible for (1) selecting the appropriate TI products for your application, (2) designing, validating and testing your application, and (3) ensuring your application meets applicable standards, and any other safety, security, regulatory or other requirements.

These resources are subject to change without notice. TI grants you permission to use these resources only for development of an application that uses the TI products described in the resource. Other reproduction and display of these resources is prohibited. No license is granted to any other TI intellectual property right or to any third party intellectual property right. TI disclaims responsibility for, and you will fully indemnify TI and its representatives against, any claims, damages, costs, losses, and liabilities arising out of your use of these resources.

TI's products are provided subject to [TI's Terms of Sale](#) or other applicable terms available either on [ti.com](https://www.ti.com) or provided in conjunction with such TI products. TI's provision of these resources does not expand or otherwise alter TI's applicable warranties or warranty disclaimers for TI products.

TI objects to and rejects any additional or different terms you may have proposed.

Mailing Address: Texas Instruments, Post Office Box 655303, Dallas, Texas 75265
Copyright © 2023, Texas Instruments Incorporated