

LM36922H 高效双串白色 LED 驱动器

1 特性

- 整个过程、电压、温度范围内的灌电流匹配度为 1%
- 整个过程、电压、温度范围内的灌电流精度为 3%
- 11 位调光分辨率
- 解决方案效率最高可达 90%
- 在电压高达 38V、每条灯串的电流为 25mA 的条件下，可驱动一至两条并行发光二极管 (LED) 灯串
- 脉宽调制 (PWM) 调光输入
- I²C 可编程
- 500kHz 和 1MHz 可选开关频率，可选频移为 -12%
- 自动切换频率模式 (250kHz、500kHz 和 1MHz)
- 四个可配置过压保护阈值 (17V、24V、31V 和 38V)
- 四个可配置过流保护阈值 (750mA、1000mA、1250mA 和 1500mA)
- 热关断保护
- 通过 ASEL 输入在外部选择 I²C 地址选项

2 应用

- 针对智能手机和平板电脑背光照明的电源
- LED 最多可达 24 个的液晶显示屏 (LCD) 面板

3 说明

LM36922H 是一款专为 LCD 显示屏背光照明而设计的超紧凑型、高效双串白色 LED 驱动器。该器件最多可为 12 个串联 LED 供电，每条灯串的电流高达 25mA。该器件采用自适应电流调节方法，可在保持电流稳定的同时为每个灯串提供不同的 LED 电压。

LED 电流通过 I²C 接口或逻辑电平 PWM 输入进行调节。PWM 占空比在内部进行感测并映射到一个 11 位电流，从而提供宽 PWM 频率范围并在 50 μ A 至 25mA 范围内实现无噪声运行。

其他特性包括可根据负载电流自动更改频率的自动频率模式，其作用是提升效率。

该器件可在 2.5V 至 5.5V 输入电压范围内运行，其运行温度范围为 -40°C 至 +85°C。

器件信息⁽¹⁾

器件型号	封装	封装尺寸 (最大值)
LM36922H	DSBGA (12)	1.756mm x 1.355mm

(1) 要了解所有可用封装，请参见数据表末尾的可订购产品附录。

简化电路原理图

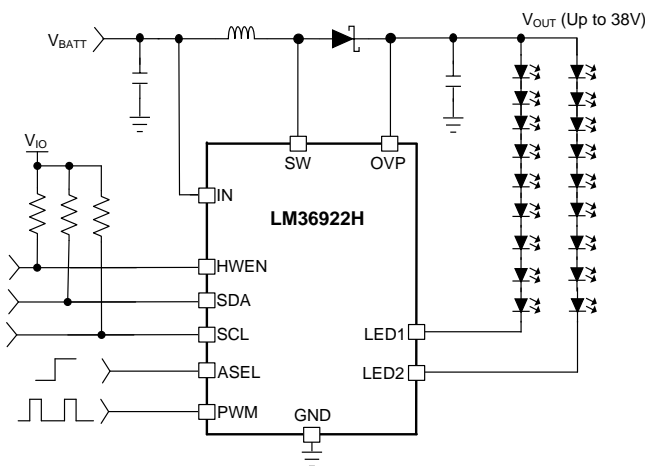

灯串间匹配与 LED 电流间的典型关系

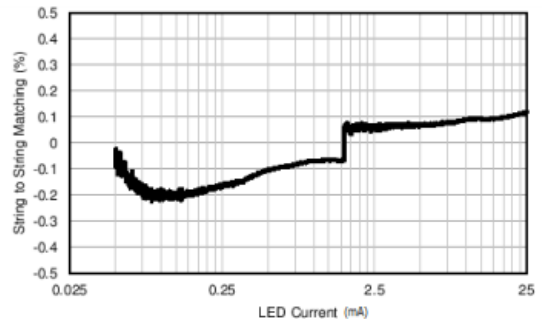

目录

<ul style="list-style-type: none"> 1 特性 1 2 应用 1 3 说明 1 4 修订历史记录 2 5 Pin Configuration and Functions 3 6 Specifications 4 <ul style="list-style-type: none"> 6.1 Absolute Maximum Ratings 4 6.2 ESD Ratings 4 6.3 Recommended Operating Conditions 4 6.4 Thermal Information 4 6.5 Electrical Characteristics 5 6.6 I²C Timing Requirements 6 6.7 Typical Characteristics 7 7 Detailed Description 10 <ul style="list-style-type: none"> 7.1 Overview 10 7.2 Functional Block Diagram 10 7.3 Feature Description 11 7.4 Device Functional Modes 16 	<ul style="list-style-type: none"> 7.5 Programming 24 7.6 Register Maps 25 8 Applications and Implementation 27 <ul style="list-style-type: none"> 8.1 Application Information 27 8.2 Typical Application 27 9 Power Supply Recommendations 34 <ul style="list-style-type: none"> 9.1 Input Supply Bypassing 34 10 Layout 34 <ul style="list-style-type: none"> 10.1 Layout Guidelines 34 10.2 Layout Example 37 11 器件和文档支持 38 <ul style="list-style-type: none"> 11.1 器件支持 38 11.2 商标 38 11.3 社区资源 38 11.4 静电放电警告 38 11.5 Glossary 38 12 机械、封装和可订购信息 38
--	--

4 修订历史记录

注：之前版本的页码可能与当前版本有所不同。

Changes from Original (February 2016) to Revision A	Page
<ul style="list-style-type: none"> • 已更改 器件状态“产品预览”至“量产数据” 1 	1

5 Pin Configuration and Functions

**YFF Package
12-Pin DSBGA
Top View**

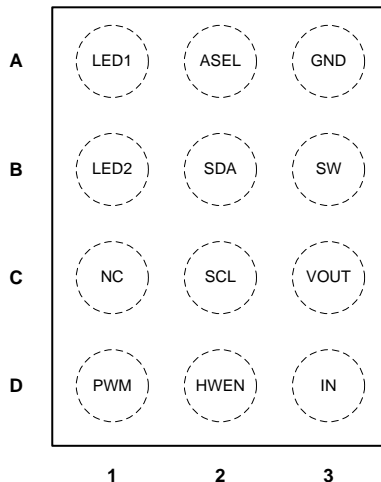

Pin Functions

PIN		I/O	DESCRIPTION
NUMBER	NAME		
A1	LED1	Input	Input to current sink 1. The boost converter regulates the minimum voltage between LED1, LED2 to VHR.
A2	ASEL	Input	ASEL is a logic input which selects between two I ² C address options. This pin is read on power up (V _{IN} going above 1.8 V, and HWEN going above a logic high voltage). GND = address 0x36, logic high = address 0x37.
A3	GND	Input	Ground
B1	LED2	Input	Input pin to current sink 2. The boost converter regulates the minimum voltage between LED1, LED2 to VHR.
B2	SDA	I/O	Data I/O for I ² C-Compatible Interface.
B3	SW	Output	Drain connection for internal low side NFET, and anode connection for external Schottky diode.
C1	NC	Input	Unused pin. Connect externally to GND.
C2	SCL	Input	Clock input for I ² C-compatible interface.
C3	OUT	Input	OUT serves as the sense point for overvoltage protection. Connect OUT to the positive pin of the output capacitor.
D1	PWM	Input	Logic level input for PWM current control.
D2	HWEN	Input	Hardware enable input. Drive HWEN high to bring the device out of shutdown and allow I ² C writes or PWM control.
D3	IN	Input	Input voltage connection. Bypass IN to GND with a minimum 2.2-μF ceramic capacitor.

6 Specifications

6.1 Absolute Maximum Ratings

over operating free-air temperature range (unless otherwise noted)⁽¹⁾

		MIN	MAX	UNIT
IN	Input voltage	-0.3	6	V
OUT	Output overvoltage sense input	-0.3	40	V
SW	Inductor connection	-0.3	40	V
LED1, LED2	LED string cathode connection	-0.3	30	V
HWEN, PWM, SDA, SCL, ASEL	Logic I/Os	-0.3	6	V
Maximum junction temperature, T_{J_MAX}			150	°C
Storage temperature, T_{stg}		-65	150	°C

- (1) Stresses beyond those listed under *Absolute Maximum Ratings* may cause permanent damage to the device. These are stress ratings only, which do not imply functional operation of the device at these or any other conditions beyond those indicated under *Recommended Operating Conditions*. Exposure to absolute-maximum-rated conditions for extended periods may affect device reliability.

6.2 ESD Ratings

		VALUE	UNIT
$V_{(ESD)}$	Electrostatic discharge	Human-body model (HBM), per ANSI/ESDA/JEDEC JS-001 ⁽¹⁾	±2000
		Charged-device model (CDM), per JEDEC specification JESD22-C101 ⁽²⁾	±500

- (1) JEDEC document JEP155 states that 500-V HBM allows safe manufacturing with a standard ESD control process. Pins listed as ±2000 V may actually have higher performance.
- (2) JEDEC document JEP157 states that 250-V CDM allows safe manufacturing with a standard ESD control process. Pins listed as ±500 V may actually have higher performance.

6.3 Recommended Operating Conditions

over operating free-air temperature range (unless otherwise noted)

		MIN	MAX	UNIT
IN	Input voltage	2.5	5.5	V
OUT	Overvoltage sense input	0	38	V
SW	Inductor connection	0	38	V
LED1, LED2	LED string cathode connection	0	29.5	V
HWEN, PWM, SDA, SCL, ASEL	Logic I/Os	0	5.5	V

6.4 Thermal Information

THERMAL METRIC ⁽¹⁾		LM36922H	UNIT
		YFQ (DSBGA)	
		12 PINS	
$R_{\theta JA}$	Junction-to-ambient thermal resistance	88.9	°C/W
$R_{\theta JC(top)}$	Junction-to-case (top) thermal resistance	0.7	°C/W
$R_{\theta JB}$	Junction-to-board thermal resistance	43.9	°C/W
$\Psi_{\theta JT}$	Junction-to-top characterization parameter	2.9	°C/W
$\Psi_{\theta JB}$	Junction-to-board characterization parameter	43.7	°C/W

- (1) For more information about traditional and new thermal metrics, see the *Semiconductor and IC Package Thermal Metrics* application report, [SPRA953](#).

6.5 Electrical Characteristics

Minimum and maximum limits apply over the full operating ambient temperature range ($-40^{\circ}\text{C} \leq T_A \leq 85^{\circ}\text{C}$), typical values are at $T_A = 25^{\circ}\text{C}$, and $V_{IN} = 3.6\text{ V}$ (unless otherwise noted).

PARAMETER		TEST CONDITIONS		MIN	TYP	MAX	UNIT
BOOST							
$I_{MATCH}^{(1)}$	LED current matching I_{LED1} to I_{LED2}	$50\ \mu\text{A} \leq I_{LED} \leq 25\ \text{mA}$, $2.7\ \text{V} \leq V_{IN} \leq 5\ \text{V}$ (linear or exponential mode)		-1%	0.1%	1%	
Accuracy	Absolute accuracy (I_{LED1} , I_{LED2})	$50\ \mu\text{A} \leq I_{LED} \leq 25\ \text{mA}$, $2.7\ \text{V} \leq V_{IN} \leq 5\ \text{V}$ (linear or exponential mode)		-3%	0.1%	3%	
I_{LED_MIN}	Minimum LED current (per string)	PWM or I ² C current control (linear or exponential mode)		50			μA
I_{LED_MAX}	Maximum LED current (per string)			25			mA
R_{DNL}	IDAC ratio-metric DNL	exponential mode only		1/3 (0.3%)			LSB
V_{HR}	Regulated current sink headroom voltage	$I_{LED} = 25\ \text{mA}$		210			mV
		$I_{LED} = 5\ \text{mA}$		100			
V_{HR_MIN}	Current sink minimum headroom voltage	$I_{LED} = 95\%$ of nominal, $I_{LED} = 5\ \text{mA}$		35	50		mV
Efficiency	Typical efficiency	$V_{IN} = 3.7\ \text{V}$, $I_{LED} = 5\ \text{mA/string}$, typical application circuit (2x8 LEDs), P_{OUT}/P_{IN})		86%			
R_{NMOS}	NMOS switch on resistance	$I_{SW} = 250\ \text{mA}$		0.29			Ω
I_{CL}	NMOS switch current limit	$2.7\ \text{V} \leq V_{IN} \leq 5\ \text{V}$	OCP = 00	575	750	875	mA
			OCP = 01	860	1000	1110	
			OCP = 10	1100	1250	1400	
			OCP = 11	1350	1500	1650	
V_{OVP}	Output overvoltage protection	ON threshold, $2.7\ \text{V} \leq V_{IN} \leq 5\ \text{V}$	OVP = 00	16	17	17.5	V
			OVP = 01	23	24	25	
			OVP = 10	30	31	32	
			OVP = 11	37	38	39	
OVP Hysteresis			0.5			V	
f_{SW}	Switching frequency	$2.7\ \text{V} \leq V_{IN} \leq 5\ \text{V}$, boost frequency shift = 0	Boost frequency select = 0	475	500	525	kHz
			Boost frequency select = 1	950	1000	1050	
D_{MAX}	Maximum boost duty cycle			92%	94%		
I_{SHDN}	Shutdown current	Chip enable bit = 0, SDA = SCL = IN or GND, $2.7\ \text{V} \leq V_{IN} \leq 5\ \text{V}$		1.2			5 μA
T_{SD}	Thermal shutdown			135			$^{\circ}\text{C}$
	Hysteresis			15			
PWM INPUT							
Min f_{PWM}				50			Hz
Max f_{PWM}		Sample rate = 24 MHz		50			kHz
t_{MIN_ON}	Minimum pulse ON time	Sample rate = 24 MHz		183.3			ns
		Sample rate = 4 MHz		1100			
		Sample rate = 800 kHz		5500			
t_{MIN_OFF}	Minimum pulse OFF time	Sample rate = 24 MHz		183.3			ns
		Sample rate = 4 MHz		1100			
		Sample rate = 800 kHz		5500			

(1) LED Current Matching between strings is given as the worst case matching between any two strings. Matching is calculated as $((I_{LEDX} - I_{LEDY}) / (I_{LEDX} + I_{LEDY})) \times 100$.

Electrical Characteristics (continued)

Minimum and maximum limits apply over the full operating ambient temperature range ($-40^{\circ}\text{C} \leq T_A \leq 85^{\circ}\text{C}$), typical values are at $T_A = 25^{\circ}\text{C}$, and $V_{IN} = 3.6\text{ V}$ (unless otherwise noted).

PARAMETER	TEST CONDITIONS	MIN	TYP	MAX	UNIT
$t_{\text{START-UP}}$	Turnon delay from shutdown to backlight on PWM input active, PWM = logic high, HWEN input from low to high, $f_{\text{PWM}} = 10\text{ kHz}$ (50% duty cycle)		3.5	5	ms
PWM_{RES}	PWM input resolution	1.6 kHz $\leq f_{\text{PWM}} \leq 12\text{ kHz}$, PWM hysteresis = 00, PWM sample rate = 11			bits
V_{IH}	Input logic high	HWEN, ASEL, SCL, SDA, PWM inputs			V
V_{IL}	Input logic low	HWEN, ASEL, SCL, SDA, PWM inputs			V
t_{GLITCH}	PWM input glitch rejection	PWM pulse filter = 00			ns
		PWM pulse filter = 01			
		PWM pulse filter = 10			
		PWM pulse filter = 11			
$t_{\text{PWM_STBY}}$	PWM shutdown period	Sample rate = 24 MHz			ms
		Sample rate = 4 MHz			
		Sample rate = 800 kHz			

6.6 I²C Timing Requirements

See [Figure 1](#)

		MIN	MAX	UNIT
t_1	SCL clock period	2.5		μs
t_2	Data in setup time to SCL high	100		ns
t_3	Data out stable after SCL low	0		ns
t_4	SDA low Setup Time to SCL low (start)	100		ns
t_5	SDA high hold time after SCL high (stop)	100		ns

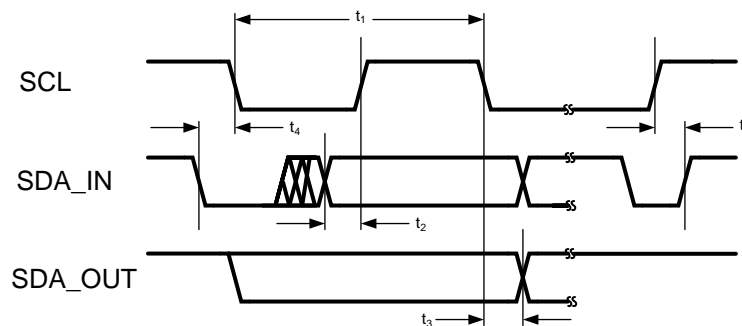

Figure 1. I²C Timing

6.7 Typical Characteristics

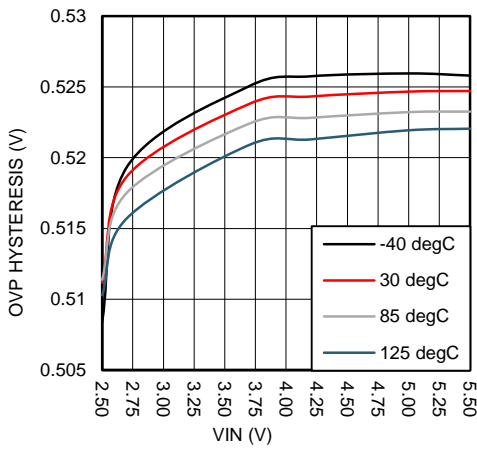

Figure 2. OVP Hysteresis

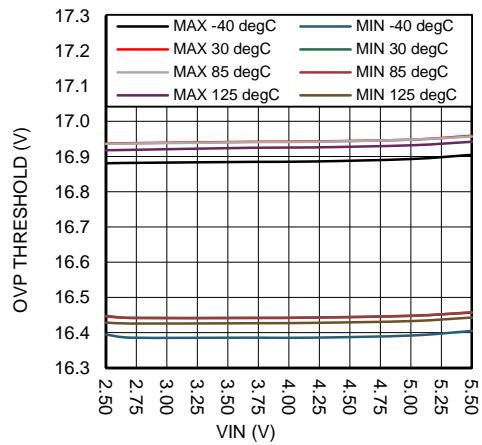

Figure 3. 17-V OVP Threshold

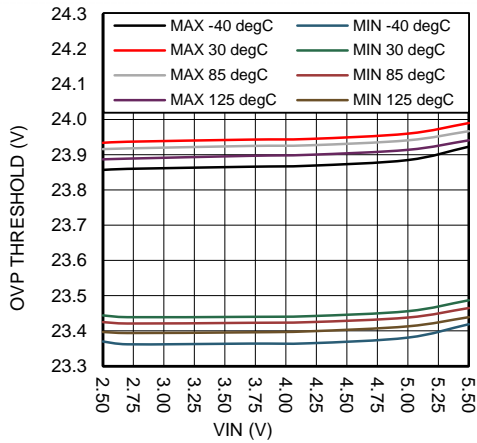

Figure 4. 24-V OVP Threshold

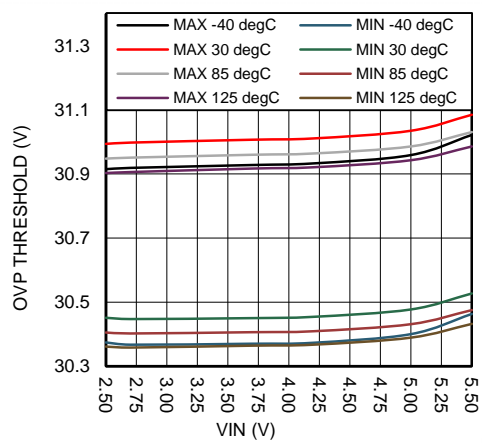

Figure 5. 31-V OVP Threshold

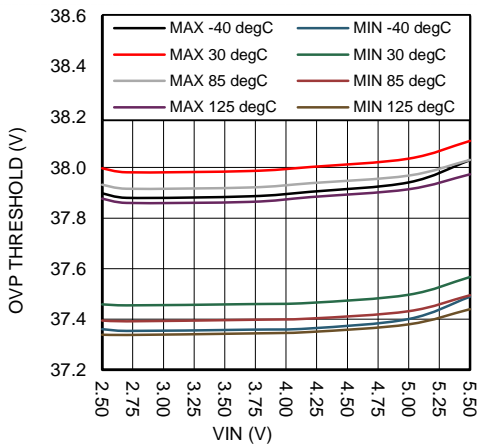

Figure 6. 38-V OVP Threshold

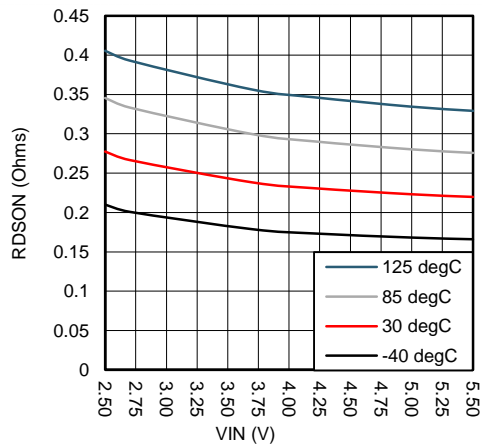
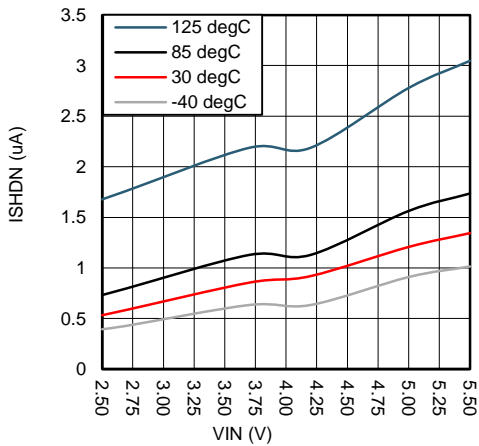

Figure 7. RDSON

Typical Characteristics (continued)



HWEN = GND

Figure 8. Shutdown Current

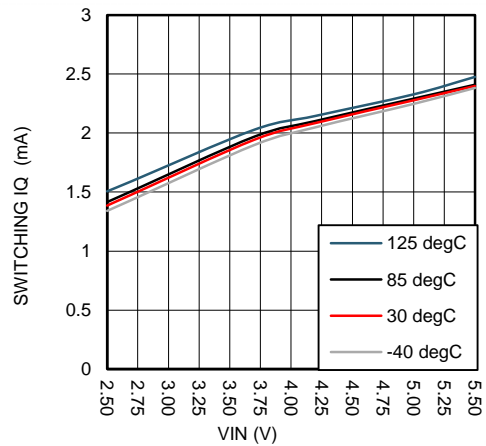

f_{SW} = 1 Mhz

No Load

Figure 9. I_Q Current (Switching)

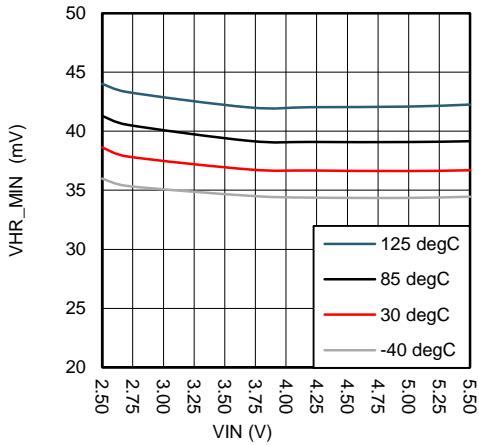

I_{LED} = 5 mA

Figure 10. VHR MIN

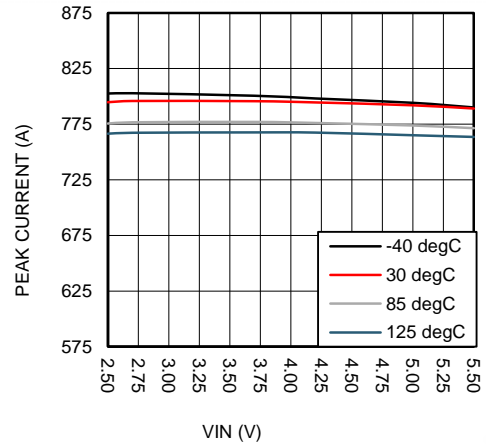

Open Loop

Figure 11. 750-mA OCP Current

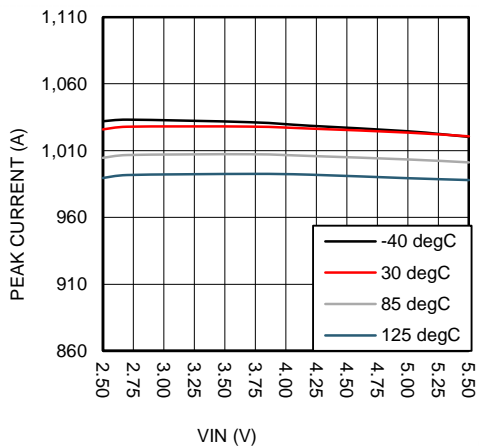

Open Loop

Figure 12. 1000-mA OCP Current

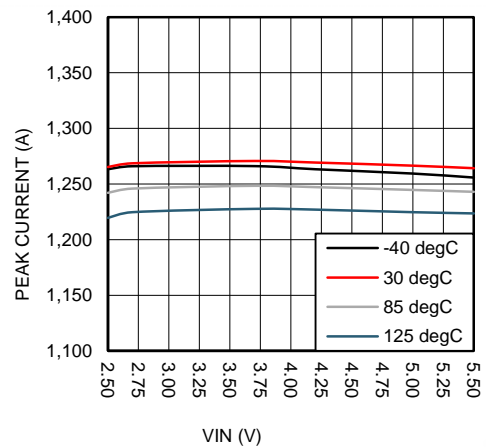

Open Loop

Figure 13. 1250-mA OCP Current

Typical Characteristics (continued)

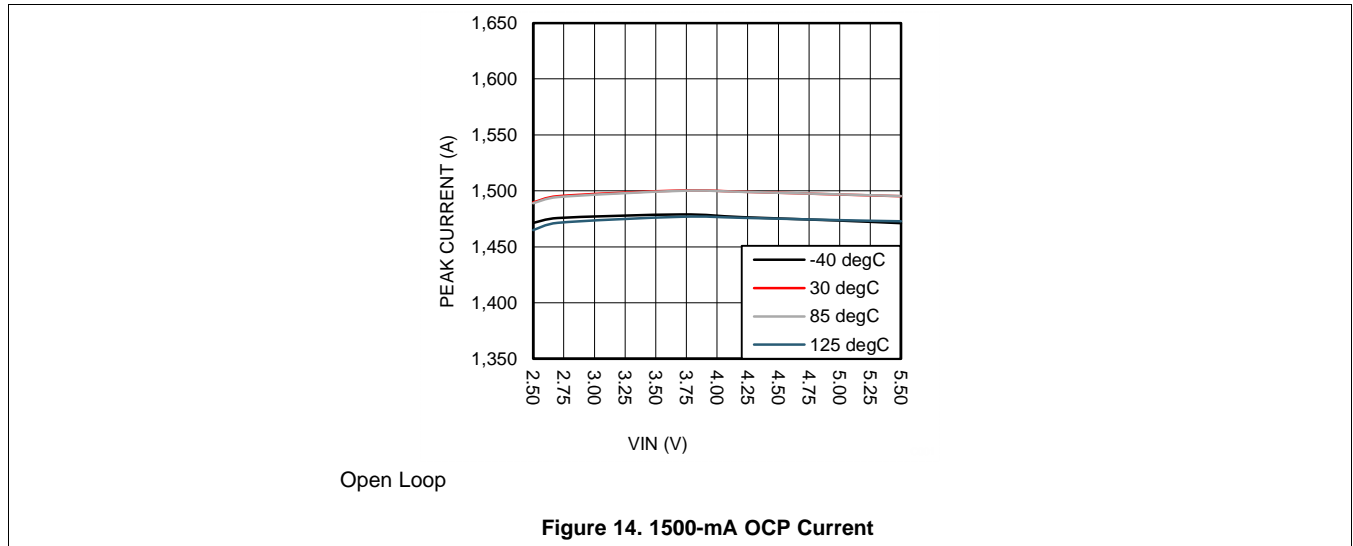

7 Detailed Description

7.1 Overview

The LM36922H is an inductive boost plus two current sinks white-LED driver designed for powering from one to two strings of white LEDs used in display backlighting. The device operates over the 2.5-V to 5.5-V input voltage range. The 11-bit LED current is set via an I²C interface, via a logic level PWM input, or a combination of both.

7.2 Functional Block Diagram

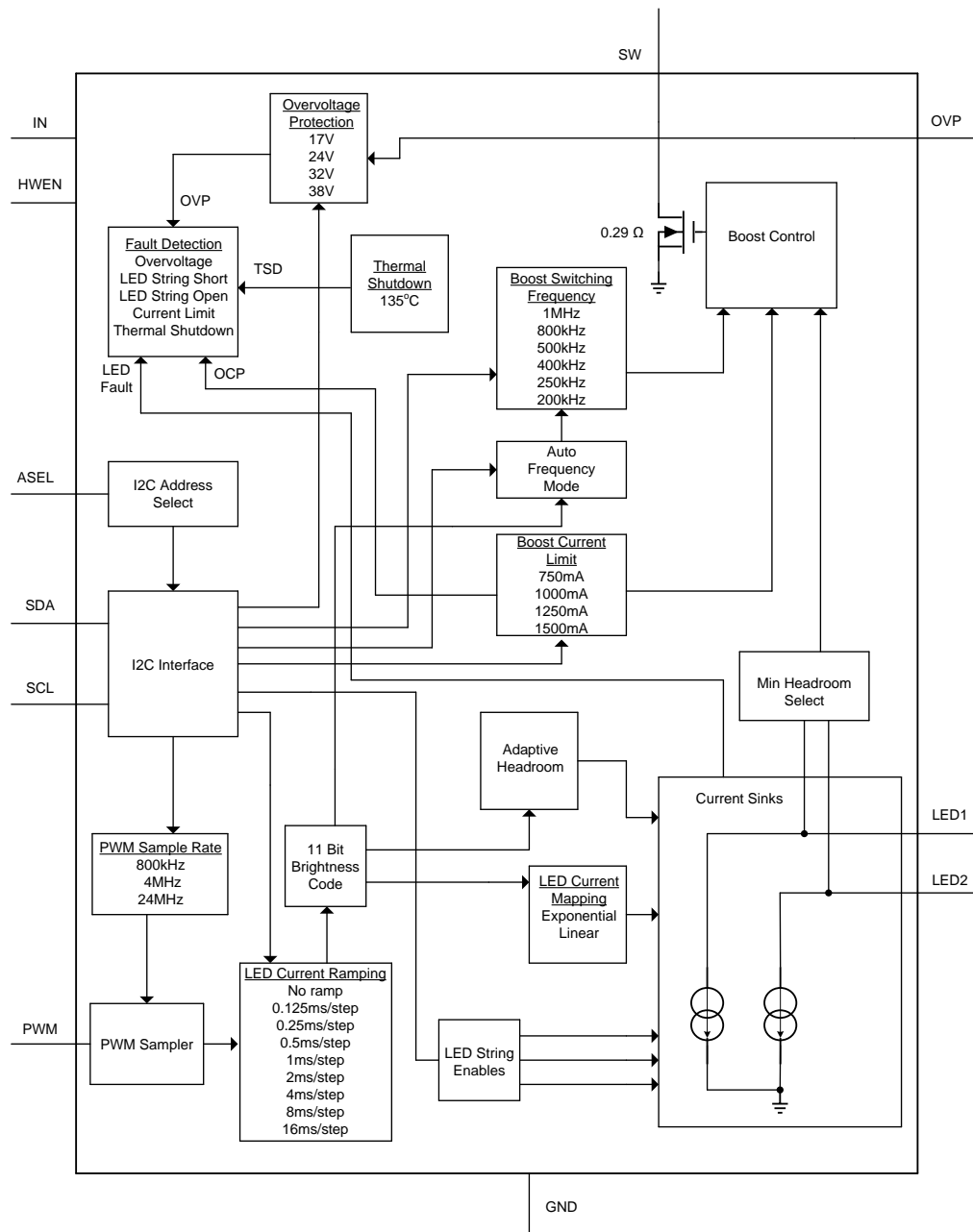

7.3 Feature Description

7.3.1 Enabling the LM36922H

The LM36922H has a logic level input HWEN which serves as the master enable/disable for the device. When HWEN is low the device is disabled, the registers are reset to their default state, the I²C bus is inactive, and the device is placed in a low-power shutdown mode. When HWEN is forced high the device is enabled, and I²C writes are allowed to the device.

7.3.1.1 Current Sink Enable

Each current sink in the device has a separate enable input. This allows for a 1-string or 2-string application. The default is with two strings enabled. Once the correct LED string configuration is programmed, the device can be enabled by writing the chip enable bit high (register 0x10 bit[0]), and then either enabling PWM and driving PWM high, or writing a non-zero code to the brightness registers.

The default setting for the device is with the chip enable bit set to 1, PWM input enabled, and the device in linear mapped mode. Therefore, on power up once HWEN is driven high, the device enters the standby state and actively monitors the PWM input. After a non-zero PWM duty cycle is detected the LM36922H converts the duty cycle information to the linearly weighted 11-bit brightness code. This allows for operation of the device in a stand-alone configuration without the need for any I²C writes. Figure 15 and Figure 16 describe the start-up timing for operation with both PWM controlled current and with I²C controlled current.

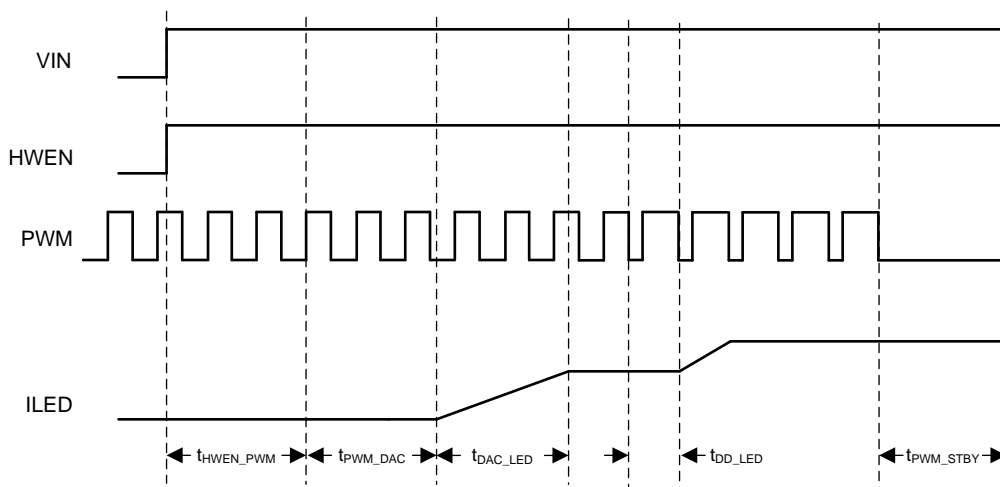

Figure 15. Enabling the LM36922H via PWM

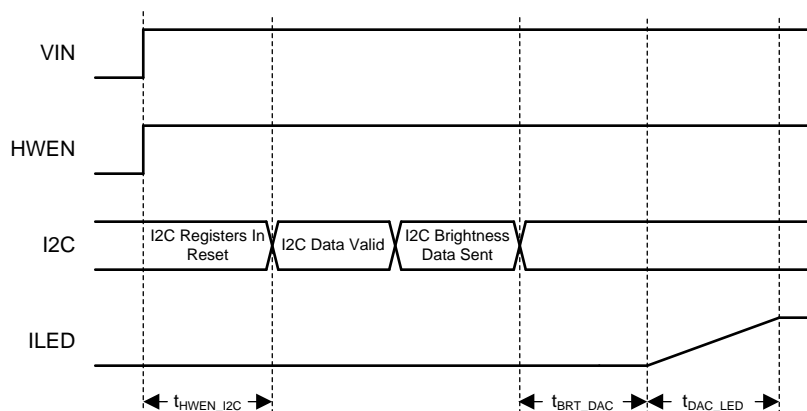

Figure 16. Enabling the LM36922H via I²C

Feature Description (continued)

7.3.2 LM36922H Start-Up

The LM36922H can be enabled or disabled in various ways. When disabled, the device is considered shutdown, and the quiescent current drops to I_{SHDN} . When the device is in standby, it returns to the I_{SHDN} current level retaining all programmed register values. [Table 1](#) describes the different operating states for the LM36922H.

Table 1. LM36922H Operating Modes

LED STRING ENABLES 0x10 bits[2:1]	PWM INPUT	I ² C BRIGHTNESS REGISTERS 0x18 bits[2:0] 0x19 bits[7:0]	BRIGHTNESS MODE 0x11 bits[6:5]	DEVICE ENABLE 0x10 bit[0]	LED CURRENT	
					(EXP MAPPING) 0x11 bit[7] = 1	(LIN MAPPING) 0x11 bit[7] = 0
XXX	X	XXX	XX	0	Off, device disabled	
0	X	XXX	XX	1	Off, device standby	
At least one enabled	X	0	00	1	Off, device in standby	
At least one enabled	X	Code > 000	00	1	$I_{LED} = 50 \mu A \times 1.003040572^{Code}$ See ⁽¹⁾	$LED = 37.806 \mu A + 12.195 \mu A \times Code$ See ⁽¹⁾
At least one enabled	0	XXX	01	1	Off, device in standby	
At least one enabled	PWM Signal	XXX	01	1	$I_{LED} = 50 \mu A \times 1.003040572^{Code}$ See ⁽¹⁾	$LED = 37.806 \mu A + 12.195 \mu A \times Code$ See ⁽¹⁾
At least one enabled	0	XXX	10 or 11	1	Off, device in standby	
At least one enabled	X	0	10 or 11	1	Off, device in standby	
At least one enabled	PWM Signal	Code > 000	10 or 11	1	$I_{LED} = 50 \mu A \times 1.003040572^{Code}$ See ⁽¹⁾	$LED = 37.806 \mu A + 12.195 \mu A \times Code$ See ⁽¹⁾

(1) Code is the 11-bit code output from the ramper (see [Figure 21](#), [Figure 23](#), [Figure 25](#), [Figure 27](#)). This can be the I²C brightness code, the converted PWM duty cycle or the 11-bit product of both.

7.3.3 Brightness Mapping

There are two different ways to map the brightness code (or PWM duty cycle) to the LED current: linear and exponential mapping.

7.3.3.1 Linear Mapping

For linear mapped mode the LED current increases proportionally to the 11-bit brightness code and follows the relationship:

$$I_{LED} = 37.806\mu A + 12.195\mu A \times Code \quad (1)$$

This is valid from codes 1 to 2047. Code 0 programs 0 current. Code is an 11-bit code that can be the I²C brightness code, the digitized PWM duty cycle, or the product of the two.

7.3.3.2 Exponential Mapping

In exponential mapped mode the LED current follows the relationship:

$$I_{LED} = 50\mu A \times 1.003040572^{Code} \quad (2)$$

This results in an LED current step size of approximately 0.304% per code. This is valid for codes from 1 to 2047. Code 0 programs 0 current. Code is an 11-bit code that can be the I²C brightness code, the digitized PWM duty cycle, or the product of the two. [Figure 17](#) details the LED current exponential response.

The 11-bit (0.304%) per code step is small enough such that the transition from one code to the next in terms of LED brightness is not distinguishable to the eye. This therefore gives a perfectly smooth brightness increase between adjacent codes.

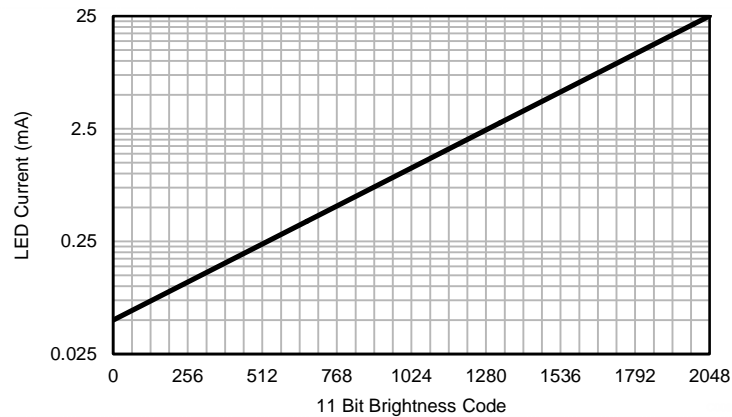

Figure 17. LED Current vs Brightness Code (Exponential Mapping)

7.3.4 PWM Input

The PWM input is a sampled input which converts the input duty cycle information into an 11-bit brightness code. The use of a sampled input eliminates any noise and current ripple that traditional PWM controlled LED drivers are susceptible to.

The PWM input uses logic level thresholds with $V_{IH_MIN} = 1.25\text{ V}$ and $V_{IL_MAX} = 0.4\text{ V}$. Because this is a sampled input, there are limits on the max PWM input frequency as well as the resolution that can be achieved.

7.3.4.1 PWM Sample Frequency

There are four selectable sample rates for the PWM input. The choice of sample rate depends on three factors:

1. Required PWM Resolution (input duty cycle to brightness code, with 11 bits max)
2. PWM Input Frequency
3. Efficiency

7.3.4.1.1 PWM Resolution and Input Frequency Range

The PWM input frequency range is 50 Hz to 50 kHz. To achieve the full 11-bit maximum resolution of PWM duty cycle to the LED brightness code (BRT), the input PWM duty cycle must be ≥ 11 bits, and the PWM sample period ($1/f_{SAMPLE}$) must be smaller than the minimum PWM input pulse width. Figure 18 shows the possible brightness code resolutions based on the input PWM frequency. The minimum PWM frequency for each PWM sample rate is described in [PWM Timeout](#).

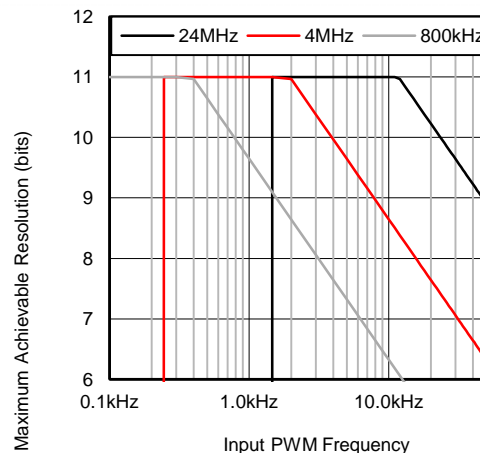

Figure 18. PWM Sample Rate, Resolution, and PWM Input Frequency

7.3.4.1.2 PWM Sample Rate and Efficiency

Efficiency is maximized when the lowest f_{SAMPLE} is chosen as this lowers the quiescent operating current of the device. [Table 2](#) describes the typical efficiency tradeoffs for the different sample clock settings.

Table 2. PWM Sample Rate Trade-Offs

PWM SAMPLE RATE (f_{SAMPLE})	TYPICAL INPUT CURRENT, DEVICE ENABLED $I_{\text{LED}} = 10 \text{ mA/string, } 2 \times 7 \text{ LEDs}$	TYPICAL EFFICIENCY
(0x12 Bits[7:6])	$f_{\text{SW}} = 1 \text{ MHz}$	$V_{\text{IN}} = 3.7 \text{ V}$
0	1.03 mA	89.7%
1	1.05 mA	89.6%
1X	1.35 mA	89.4%

7.3.4.1.2.1 PWM Sample Rate Example

The number of bits of resolution on the PWM input varies according to the PWM Sample rate and PWM input frequency.

Table 3. PWM Resolution vs PWM Sample Rate

PWM FREQUENCY (kHz)	RESOLUTION (PWM SAMPLE RATE = 800 kHz)	RESOLUTION (PWM SAMPLE RATE = 4 MHz)	RESOLUTION (PWM SAMPLE RATE = 24 MHz)
0.4	11	11	11
2	8.6	11	11
12	6.1	8.4	11

7.3.4.2 PWM Hysteresis

To prevent jitter at the input PWM signal from feeding through the PWM path and causing oscillations in the LED current, the LM36922H offers seven selectable hysteresis settings. The hysteresis works by forcing a specific number of 11-bit LSB code transitions to occur in the input duty cycle before the LED current changes. [Table 4](#) describes the hysteresis. The hysteresis only applies during the change in direction of brightness currents. Once the change in direction has taken place, the PWM input must overcome the required LSB(s) of the hysteresis setting before the brightness change takes effect. Once the initial hysteresis has been overcome and the direction in brightness change remains the same, the PWM to current response changes with no hysteresis.

Table 4. PWM Input Hysteresis

HYSTERESIS SETTING (0x12 Bits[4:2])	MIN CHANGE IN PWM PULSE WIDTH (Δt) REQUIRED TO CHANGE LED CURRENT, AFTER DIRECTION CHANGE (for $f_{\text{PWM}} < 11.7 \text{ kHz}$)	MIN CHANGE IN PWM DUTY CYCLE (ΔD) REQUIRED TO CHANGE LED CURRENT AFTER DIRECTION CHANGE	MIN (ΔI_{LED}), INCREASE FOR INITIAL CODE CHANGE	
			EXPONENTIAL MODE	LINEAR MODE
000 (0 LSB)	$1/(f_{\text{PWM}} \times 2047)$	0.05%	0.30%	0.05%
001 (1 LSB)	$1/(f_{\text{PWM}} \times 1023)$	0.10%	0.61%	0.10%
010 (2 LSBs)	$1/(f_{\text{PWM}} \times 511)$	0.20%	1.21%	0.20%
011 (3 LSBs)	$1/(f_{\text{PWM}} \times 255)$	0.39%	2.40%	0.39%
100 (4 LSBs)	$1/(f_{\text{PWM}} \times 127)$	0.78%	4.74%	0.78%
101 (5 LSBs)	$1/(f_{\text{PWM}} \times 63)$	1.56%	9.26%	1.56%
110 (6 LSBs)	$1/(f_{\text{PWM}} \times 31)$	3.12%	17.66%	3.12%

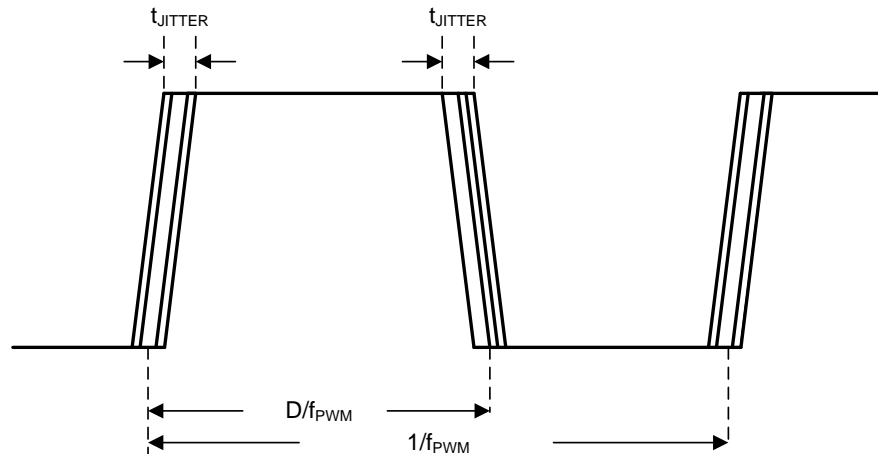

- D is $t_{\text{JITTER}} \times f_{\text{PWM}}$ or equal to #LSB's = $\Delta D \times 2048$ codes.
- For 11-bit resolution, #LSBs is equal to a hysteresis setting of $\text{LN}(\#\text{LSB's})/\text{LN}(2)$.
- For example, with a t_{JITTER} of 1 μs and a f_{PWM} of 5 kHz, the hysteresis setting should be:
 $\text{LN}(1 \mu\text{s} \times 5 \text{ kHz} \times 2048)/\text{LN}(2) = 3.35$ (4 LSBs).

Figure 19. PWM Hysteresis Example

7.3.4.3 PWM Step Response

The LED current response due to a step change in the PWM input is approximately 2 ms to go from minimum LED current to maximum LED current.

7.3.4.4 PWM Timeout

The LM36922H PWM timeout feature turns off the boost output when the PWM is enabled and there is no PWM pulse detected. The timeout duration changes based on the PWM Sample Rate selected which results in a minimum supported PWM input frequency. The sample rate, timeout, and minimum supported PWM frequency are summarized in Table 5.

Table 5. PWM Timeout and Minimum Supported PWM Frequency vs PWM Sample Rate

SAMPLE RATE	TIMEOUT	MINIMUM SUPPORTED PWM FREQUENCY
0.8 MHz	25 msec	48 Hz
4 MHz	3 msec	400 Hz
24 MHz	0.6 msec	2000 Hz

7.3.5 LED Current Ramping

There are 8 programmable ramp rates available in the LM36922H. These ramp rates are programmable as a time per step. Therefore, the ramp time from one current set-point to the next, depends on the number of code steps between currents and the programmed time per step. This ramp time to change from one brightness set-point (Code A) to the next brightness set-point (Code B) is given by:

$$\Delta t = \text{Ramp_rate} \times (\text{Code B} - \text{Code A} - 1) \quad (3)$$

For example, assume the ramp is enabled and set to 1 ms per step. Additionally, the brightness code is set to 0x444 (1092d). Then the brightness code is adjusted to 0x7FF (2047d). The time the current takes to ramp from the initial set-point to max brightness is:

$$\Delta t = \frac{1\text{ms}}{\text{step}} \times (0x7FF - 0x444 - 1) = 954\text{ms} \quad (4)$$

7.3.6 Regulated Headroom Voltage

In order to optimize efficiency, current accuracy, and string-to-string matching the LED current sink regulated headroom voltage (VHR) varies with the target LED current. [Figure 20](#) details the typical variation of VHR with LED current. This allows for increased solution efficiency as the dropout voltage of the LED driver changes. Furthermore, in order to ensure that both current sinks remain in regulation whenever there is a mismatch in string voltages, the minimum headroom voltage between VLED1, VLED2 becomes the regulation point for the boost converter. For example, if the LEDs connected to LED1 require 12 V, the LEDs connected to LED2 require 12.5 V at the programmed current, then the voltage at LED1 is VHR + 0.5 V and the voltage at LED2 is VHR. In other words, the boost makes the cathode of the highest voltage LED string the regulation point.

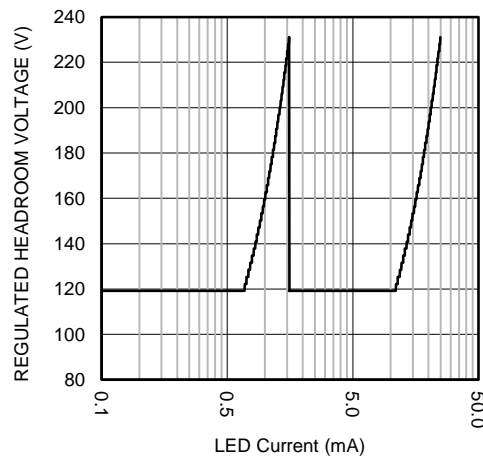

Figure 20. LM36922H Typical Exponential Regulated Headroom Voltage vs Programmed LED Current

7.4 Device Functional Modes

7.4.1 Brightness Control Modes

The LM36922H has four brightness control modes:

1. I²C Only (brightness mode 00)
2. PWM Only (brightness mode 01)
3. I²C × PWM with ramping only between I²C codes (brightness mode 10)
4. I²C × PWM with ramping between I²C × PWM changes (brightness mode 11)

Device Functional Modes (continued)

7.4.1.1 I²C Only (Brightness Mode 00)

In brightness control mode 00 the I²C Brightness registers are in control of the LED current, and the PWM input is disabled. The brightness data (BRT) is the concatenation of the two brightness registers (3 LSBs) and (8 MSBs) (registers 0x18 and 0x19, respectively). The LED current only changes when the MSBs are written, meaning that to do a full 11-bit current change via I²C, first the 3 LSBs are written and then the 8 MSBs are written. In this mode the ramper only controls the time from one I²C brightness set-point to the next (see Figure 21).

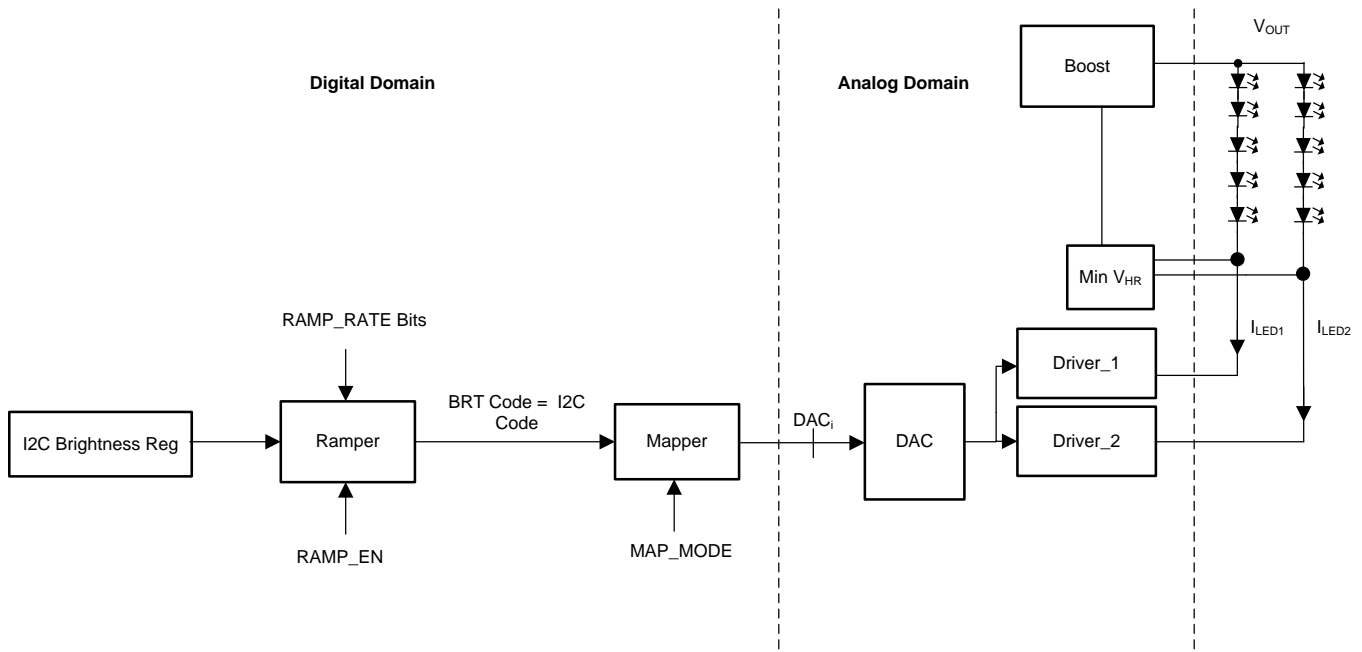
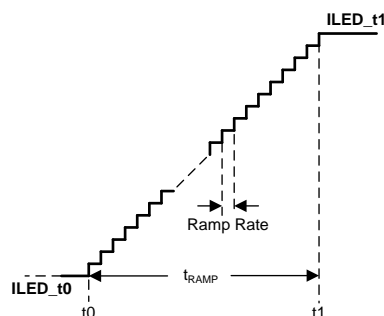

Figure 21. Brightness Control 00 (I²C Only)



1. At time t_0 the I²C Brightness Code is changed from 0x444 (1092d) to 0x7FF (2047d)
2. Ramp Rate programmed to 1ms/step
3. Mapping Mode set to Linear
4. $I_{LED_t0} = 1092 \times 12.213 \mu\text{A} = 13.337 \text{ mA}$
5. $I_{LED_t1} = 2047 \times 12.213 \mu\text{A} = 25 \text{ mA}$
6. $t_{RAMP} = (t_1 - t_0) = 1\text{ms/step} \times (2047 - 1092 - 1) = 954 \text{ ms}$

Figure 22. I²C Brightness Mode 00 Example (Ramp Between I²C Code Changes)

Device Functional Modes (continued)

7.4.1.2 PWM Only (Brightness Mode 01)

In brightness mode 01, only the PWM input sets the brightness. The I²C code is ignored. The LM36922H samples the PWM input and determines the duty cycle; this measured duty cycle is translated into an 11-bit digital code. The resultant code is then applied to the internal ramper (see Figure 23).

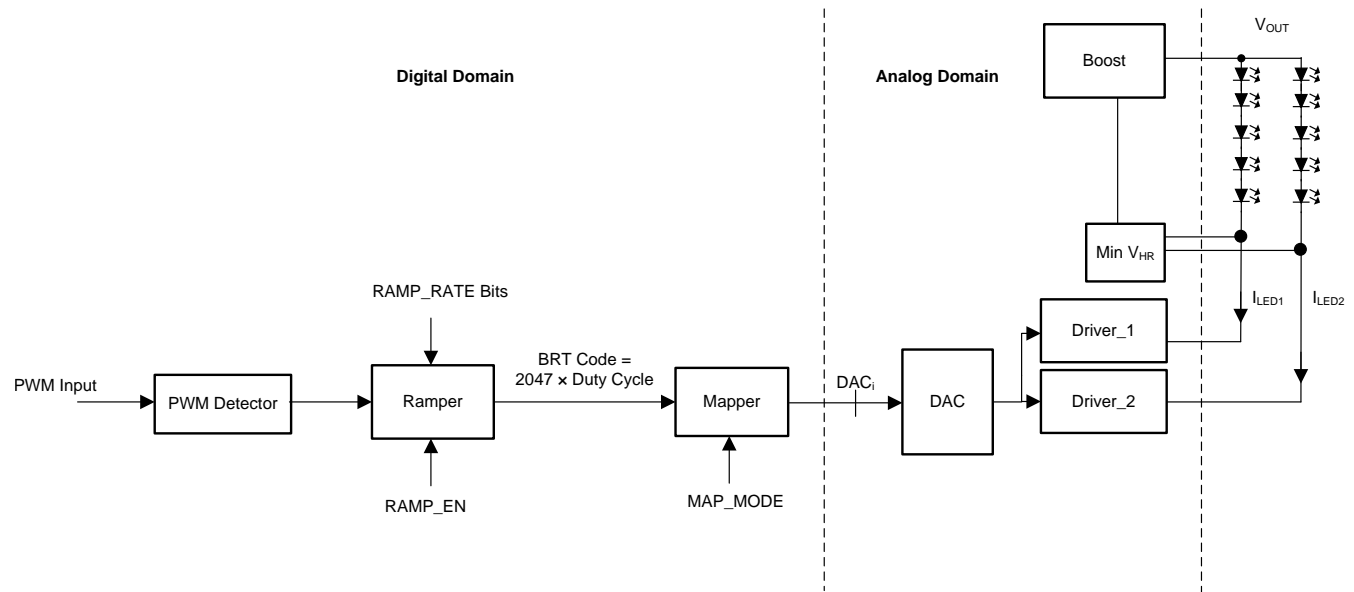
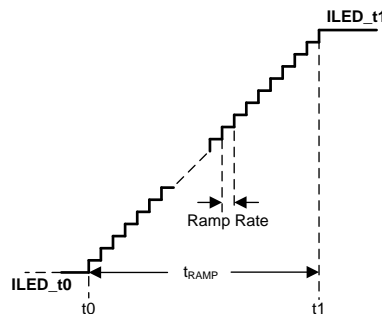

Figure 23. Brightness Control 01 (PWM Only)



1. At time t0 the PWM duty cycle changed from 25% to 100%
2. Ramp Rate programmed to 1 ms/step
3. Mapping Mode set to Linear
4. $I_{LED_t0} = 25 \text{ mA} \times 0.25 = 6.25 \text{ mA}$
5. $I_{LED_t1} = 25 \text{ mA} \times 1 = 25 \text{ mA}$
6. $t_{RAMP} = (t1 - t0) = 1 \text{ ms/step} \times (2047 \times 1 - 2047 \times 0.25 - 1) = 1534 \text{ ms}$

Figure 24. Brightness Control Mode 01 Example (Ramp Between Duty Cycle Changes)

7.4.1.3 I²C + PWM Brightness Control (Multiply Then Ramp) Brightness Mode 10

In brightness control mode 10 the I²C Brightness register and the PWM input are both in control of the LED current. In this case the I²C brightness code is multiplied with the PWM duty cycle to produce an 11-bit code which is then sent to the ramper. In this mode ramping is achieved between I²C and PWM currents (see Figure 25).

Device Functional Modes (continued)

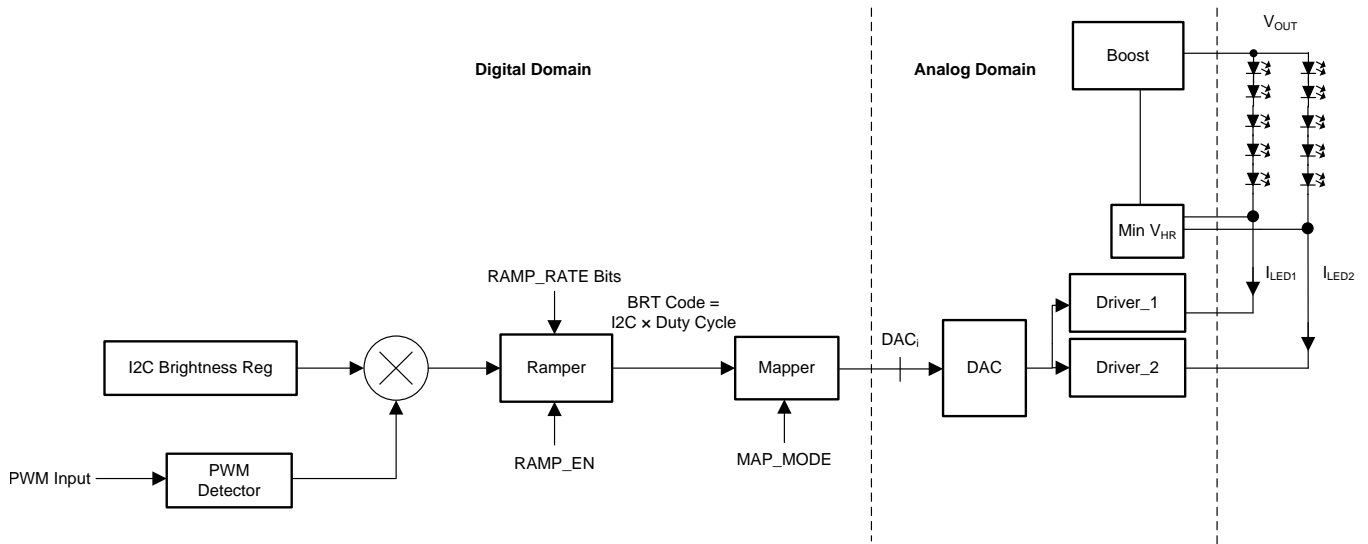
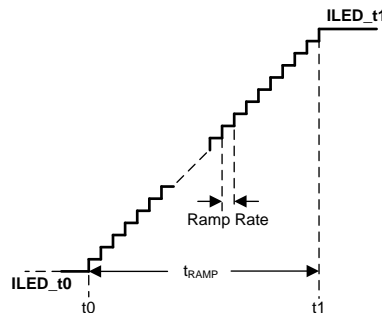

Figure 25. Brightness Control 10 (I²C + PWM)



1. At time t₀ the I²C Brightness code changed from 0x444 (1092d) to 0x7FF (2047d)
2. At time t₀ the PWM duty cycle changed from 50% to 75%
3. Ramp Rate programmed to 1ms/step
4. Mapping Mode set to Linear
5. I_{LED_t0} = 1092 × 12.213 μA × 0.5 = 6.668 mA
6. I_{LED_t1} = 2047 × 12.213 μA × 0.75 = 18.75 mA
7. t_{RAMP} = (t₁ – t₀) = 1 ms/step × (2047 × 0.75 – 1092 × 0.5 – 1) = 988 ms

Figure 26. Brightness Control Mode 10 Example (Multiply Duty Cycle then Ramp)

7.4.1.4 I²C + PWM Brightness Control (Ramp Then Multiply) Brightness Mode 11

In brightness control mode 11 both the I²C brightness code and the PWM duty cycle control the LED current. In this case the ramper only changes the time from one I²C brightness code to the next. The PWM duty cycle is multiplied with the I²C brightness code at the output of the ramper (see [Figure 27](#)).

Device Functional Modes (continued)

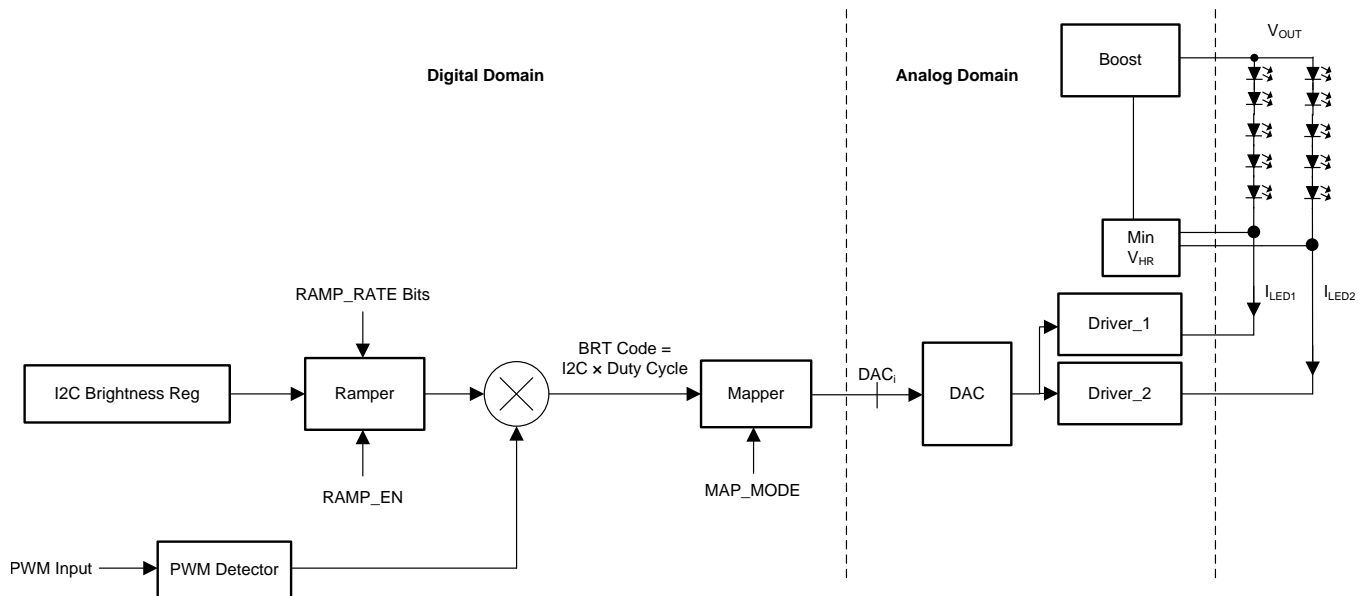
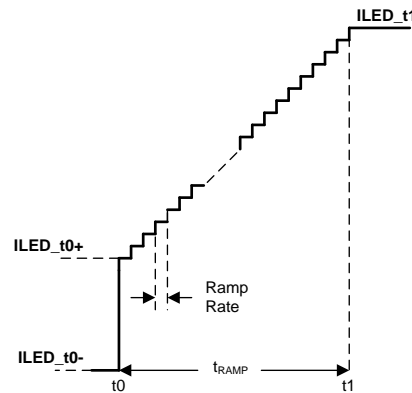

Figure 27. Brightness Control 11 (I²C + PWM)



1. At time t0 the I²C Brightness code changed from 0x444 (1092d) to 0x7FF (2047d)
2. At time t0 the PWM duty cycle changed from 50% to 75%
3. Ramp Rate programmed to 1 ms/step
4. Mapping Mode set to Linear
5. $I_{LED_t0-} = 1092 \times 12.213 \mu A \times 0.5 = 6.668 \text{ mA}$
6. $I_{LED_t0+} = 1092 \times 12.213 \mu A \times 0.75 = 10.002 \text{ mA}$
7. $t_{RAMP} = (t1 - t0) = 1 \text{ ms/step} \times (2047 - 1092 - 1) = 954 \text{ ms}$

Figure 28. Brightness Control Mode 11 Example (Ramp Current Then Multiply Duty Cycle)

7.4.2 Boost Switching Frequency

The LM36922H has two programmable switching frequencies: 500 kHz and 1 MHz. These are set via the Boost Control 1 register 0x13 bit [5]. Once the switching frequency is set, this nominal value can be shifted down by 12% via the boost switching frequency shift bit (register 0x13 bit[6]). Operation at 500 kHz is better suited for configurations which use a 10-μH inductor or use the auto-frequency mode and switch over to 500 kHz at lighter loads. Operation at 1 MHz is primarily beneficial at higher output currents, where the average inductor current is much larger than the inductor current ripple. For maximum efficiency across the entire load current range the device incorporates an automatic frequency shift mode (see [Auto-Switching Frequency](#)).

Device Functional Modes (continued)

7.4.2.1 Minimum Inductor Select

The LM36922H can use inductors in the range of 4.7 μH to 10 μH . In order to optimize the converter response to changes in V_{IN} and load, the Min Inductor Select bit (register 0x13 bit[4]) should be selected depending on which value of inductance is chosen. For 10- μH inductors this bit should be set to 1. For less than 10 μH , this bit should be set to 0.

7.4.3 Auto-Switching Frequency

To take advantage of frequency vs load dependent losses, the LM36922H has the ability to automatically change the boost switching frequency based on the magnitude of the load current. In addition to the register programmable switching frequencies of 500 kHz and 1 MHz, the auto-frequency mode also incorporates a low frequency selection of 250 kHz. It is important to note that the 250-kHz frequency is only accessible in auto-frequency mode and has a maximum boost duty cycle (D_{MAX}) of 50%.

Auto-frequency mode operates by using 2 programmable registers (Auto Frequency High Threshold (register 0x15) and Auto Frequency Low Threshold (0x16)). The high threshold determines the switchover from 1 MHz to 500 kHz. The low threshold determines the switchover from 500 kHz to 250 kHz. Both the High and Low Threshold registers take an 8-bit code which is compared against the 8 MSB of the brightness register (register 0x19). [Table 6](#) details the boundaries for this mode.

Table 6. Auto-Switching Frequency Operation

BRIGHTNESS CODE MSBs (Register 0x19 bits[7:0])	BOOST SWITCHING FREQUENCY
< Auto Frequency Low Threshold (register 15 Bits[7:0])	250 kHz ($D_{\text{MAX}} = 50\%$)
> Auto Frequency Low Threshold (Register 15 Bits[7:0]) or < Auto Frequency High Threshold (Register 14 Bits[7:0])	500 kHz
\geq Auto Frequency High Threshold (register 14 Bits[7:0])	1 MHz

Automatic-frequency mode is enabled whenever there is a non-zero code in either the Auto-Frequency High or Auto-Frequency Low registers. To disable the auto-frequency shift mode, set both registers to 0x00. When automatic-frequency select mode is disabled, the switching frequency operates at the programmed frequency (Register 0x13 bit[5]) across the entire LED current range. provides a guideline for selecting the auto-frequency 250-kHz threshold setting; the actual setting needs to be verified in the application.

Table 7. Auto Frequency 250-kHz Threshold Settings

CONDITION ($V_f = 3.2\text{ V}$, $I_{\text{LED}} = 25\text{ mA}$)	INDUCTOR (μH)	RECOMMENDED AUTO FREQUENCY LOW THRESHOLD MAXIMUM VALUE (NO SHIFT)	OUTPUT POWER AT AUTO FREQUENCY SWITCHOVER (W)
2 x 4 LEDs	10	0x2f	0.173
2 x 5 LEDs	10	0x27	0.168
2 x 6 LEDs	10	0x21	0.178
2 x 7 LEDs	10	0x1f	0.210
2 x 8 LEDs	10	0x1b	0.189

7.4.4 I²C Address Select (ASEL)

The LM36922H provides two I²C slave address options. When ASEL = GND the slave address is set to 0x36. When ASEL = VIN the slave address is set to 0x37. This static input pin is read on power up ($V_{\text{IN}} > 1.8\text{ V}$ and $\text{HWEN} > V_{\text{IH}}$) and must not be changed after power up.

7.4.5 Fault Protection/Detection

7.4.5.1 Overvoltage Protection (OVP)

The LM36922H provides four OVP thresholds (17 V, 24 V, 32 V, and 38 V). The OVP circuitry monitors the boost output voltage (V_{OUT}) and protects OUT and SW from exceeding safe operating voltages in case of open load conditions or in the event the LED string voltage requires more voltage than the programmed OVP setting. The OVP thresholds are programmed in register 13 bits[3:2]. The operation of OVP differentiates between two overvoltage conditions (see [Case 1 OVP Fault Only \(OVP Threshold Hit and All Enabled Current Sink Inputs > 40 mV\)](#), [Case 1 OVP Fault Only \(OVP Threshold Hit and All Enabled Current Sink Inputs > 40 mV\)](#), and [Case 2b OVP Fault and Open LED String Fault \(OVP Threshold Duration and Any Enabled Current Sink Input \$\leq\$ 40 mV\)](#)).

7.4.5.1.1 Case 1 OVP Fault Only (OVP Threshold Hit and All Enabled Current Sink Inputs > 40 mV)

In steady-state operation with V_{OUT} near the OVP threshold a rapid change in V_{IN} or brightness code can result in a momentary transient excursion of V_{OUT} above the OVP threshold. In this case the boost circuitry is disabled until V_{OUT} drops below OVP – hysteresis (1 V). Once this happens the boost is re-enabled and steady state regulation continues. If V_{OUT} remains above the OVP threshold for > 1 ms the OVP Flag is set (register 0x1F bit[0]).

7.4.5.1.2 Case 2a OVP Fault and Open LED String Fault (OVP Threshold Occurrence and Any Enabled Current Sink Input \leq 40 mV)

When any of the enabled LED strings is open the boost converter tries to drive V_{OUT} above OVP and at the same time the open string(s) current sink headroom voltage(s) (LED1, LED2) drop to 0. When the LM36922H detects three occurrences of $V_{OUT} > OVP$ and any enabled current sink input (V_{LED1} or V_{LED2}) \leq 40 mV, the OVP Fault flag is set (register 0x1F bit[0]), and the LED Open Fault flag is set (register 0x1F bit[4]).

7.4.5.1.3 Case 2b OVP Fault and Open LED String Fault (OVP Threshold Duration and Any Enabled Current Sink Input \leq 40 mV)

When any of the enabled LED strings is open the boost converter tries to drive V_{OUT} above OVP and at the same time the open string(s) current sink headroom voltage(s) (LED1, LED2) drop to 0. When the LM36922H detects $V_{OUT} > OVP$ for > 1 msec and any enabled current sink input (V_{LED1} or V_{LED2}) \leq 40 mV, the OVP Fault flag is set (register 0x1F bit[0]), and the LED Open Fault flag is set (register 0x1F bit[4]).

7.4.5.1.4 OVP/LED Open Fault Shutdown

The LM36922H has the option of shutting down the device when the OVP flag is set. This option can be enabled or disabled via register 0x1E bit[0]. When the shutdown option is disabled the fault flag is a report only. When the device is shut down due to an OVP/LED String Open fault, the fault flags register must be read back before the LM36922H can be re-enabled.

7.4.5.1.5 Testing for LED String Open

The procedure for detecting an open in a LED string is:

- Apply power to the LM36922H.
- Enable all LED strings (Register 0x10 = 0x07).
- Set maximum brightness (Register 0x18 = 0x07 and Register 0x19 = 0xFF).
- Set the brightness control (Register 0x11 = 0x00).
- Open LED1 string.
- Wait 4 msec.
- Read LED open fault (Register 0x1F).
- If bit[4] = 1, then a LED open fault condition has been detected.
- Connect LED1 string.
- Repeat the procedure for the other LED strings.

7.4.5.2 Voltage Limitations on LED1, LED2

The inputs to current sinks LED1, LED2 are rated for 30 V (absolute maximum voltage). This is lower than the boost output capability as set by the OVP threshold (maximum specification) of 39 V. To ensure that the current sink inputs remain below their absolute maximum rating, the LED configuration between LED1 or LED2 must not have a voltage difference between strings so that VLED1/2 have a voltage greater than 30 V.

7.4.5.3 LED String Short Fault

The LM36922H can detect an LED string short fault. This happens when the voltage between V_{IN} and any enabled current sink input has dropped below (1.5 V). This test can only be performed on one LED string at a time. Performing this test with more than one LED string enabled can result in a faulty reading. The procedure for detecting a short in a LED string is:

- Apply power the LM36922H .
- Enable only LED1 string (Register 0x10 = 0x03).
- Enable short fault (Register 0x1E = 0x01).
- Set maximum brightness (Register 0x18 = 0x07 and Register 0x19 = 0xFF).
- Set the brightness control (Register 0x11 = 0x00).
- Wait 4 msec.
- Read LED short fault (Register 0x1F).
- If bit[3] = 1, then a LED short fault condition has been detected.
- Set chip enable and LED string enable low (Register 0x10 = 0x00).
- Repeat the procedure for the other LED strings.

7.4.5.4 Overcurrent Protection (OCP)

The LM36922H has four selectable OCP thresholds (750 mA, 1000 mA, 1250 mA, and 1500 mA). These are programmable in register 0x13 bits[1:0]. The OCP threshold is a cycle-by-cycle current limit and is detected in the internal low-side NFET. Once the threshold is hit the NFET turns off for the remainder of the switching period.

7.4.5.4.1 OCP Fault

If enough overcurrent threshold events occur, the OCP Flag (register 0x1F bit[1]) is set. To avoid transient conditions from inadvertently setting the OCP Flag, a pulse density counter monitors OCP threshold events over a 128- μ s period. If 8 consecutive 128- μ s periods occur where the pulse density count has found two or more OCP events, then the OCP Flag is set.

During device start-up and during brightness code changes, there is a 4-ms blank time where OCP events are ignored. As a result, if the device starts up in an overcurrent condition there is an approximate 5-ms delay before the OCP Flag is set.

7.4.5.4.2 OCP Shutdown

The LM36922H has the option of shutting down the device when the OCP flag is set. This option can be enabled or disabled via register 0x1E bit[1]. When the shutdown option is disabled, the fault flag is a report only. When the device is shut down due to an OCP fault, the fault flags register must be read back before the LM36922H can be re-enabled.

7.4.5.5 Device Overtemperature

Thermal shutdown (TSD) is triggered when the device die temperature reaches 135°C. When this happens the boost stops switching, and the TSD Flag (register 0x1F bit[2]) is set. The boost automatically starts up again when the die temperature cools down to 120°C.

7.4.5.5.1 Overtemperature Shutdown

The LM36922H has the option of shutting down the device when the TSD flag is set. This option can be enabled or disabled via register 0x1E bit[2]. When the shutdown option is disabled the fault flag is a report only. When the device is shutdown due to a TSD fault, the Fault Flags register must be read back before the LM36922H can be re-enabled.

7.5 Programming

7.5.1 I²C Interface

7.5.1.1 Start and Stop Conditions

The LM36922H is configured via an I²C interface. START (S) and STOP (P) conditions classify the beginning and the end of the I²C session [Figure 29](#). A START condition is defined as SDA transitioning from HIGH to LOW while SCL is HIGH. A STOP condition is defined as SDA transitioning from LOW to HIGH while SCL is HIGH. The I²C master always generates the START and STOP conditions. The I²C bus is considered busy after a START condition and free after a STOP condition. During the data transmission the I²C master can generate repeated START conditions. A START and a repeated START conditions are equivalent function-wise. The data on SDA must be stable during the HIGH period of the clock signal (SCL). In other words, the state of SDA can only be changed when SCL is LOW.

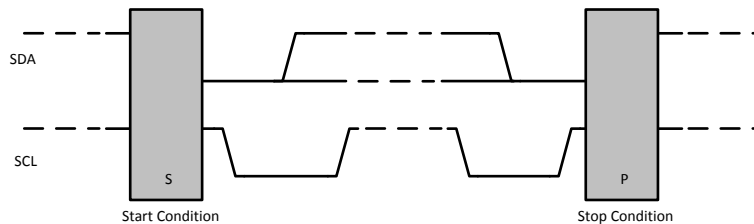

Figure 29. I²C Start and Stop Conditions

7.5.1.2 I²C Address

After the START condition the I²C master sends the 7-bit chip address followed by an eighth bit read or write (R/W). R/W = 0 indicates a WRITE, and R/W = 1 indicates a READ. The second byte following the chip address selects the register address to which the data is written. The third byte contains the data for the selected register.

7.5.1.3 Transferring Data

Every byte on the SDA line must be eight bits long with the most significant bit (MSB) transferred first. Each byte of data must be followed by an acknowledge bit (ACK). The acknowledge related clock pulse, (9th clock pulse), is generated by the master. The master then releases SDA (HIGH) during the 9th clock pulse. The LM36922H pulls down SDA during the 9th clock pulse, signifying an acknowledge. An acknowledge is generated after each byte has been received.

7.5.1.4 Register Programming

For glitch free operation, the following bits and/or registers should only be programmed while the LED Enable bits are 0 (Register 0x10, Bit [2:1] = 0) and Device Enable bit is 1 (Register 0x10, Bit[0] = 1) :

1. Register 0x11 Bit[7] (Mapping Mode)
2. Register 0x11 Bits[6:5] (Brightness Mode)
3. Register 0x11 Bit[4] (Ramp Enable)
4. Register 0x11 Bit[3:1] (Ramp Rate)
5. Register 0x12 Bits[7:6] (PWM Sample Rate)
6. Register 0x12 Bits[5] (PWM Polarity)
7. Register 0x12 Bit[3:2] (PWM Hysteresis)
8. Register 0x12 Bit[3:2] (PWM Pulse Filter)
9. Register 0x15 (auto frequency high threshold)
10. Register 0x16 (auto frequency low threshold)

7.6 Register Maps

Note: Read of reserved (R) or write-only register returns 0.

Table 8. Revision (0x00)

Bits [7:4]	Bits [3:0]
R	Revision Code

Table 9. Software Reset (0x01)

Bits [7:1]	Software Reset Bit [0]
R	0 = Normal Operation 1 = Device Reset (automatically resets back to 0)

Table 10. Enable (0x10)

Bits [7:4]	LED2 Enable Bit [2]	LED1 Enable Bit [1]	Device Enable Bit [0]
R	0 = Disabled 1 = Enabled (Default)	0 = Disabled 1 = Enabled (Default)	0 = Disabled 1 = Enabled (Default)

Table 11. Brightness Control (0x11)

Mapping Mode Bit [7]	Brightness Mode Bits [6:5]	Ramp Enable Bits [4]	Ramp Rate Bit [3:1]	Bits [0]
0 = Linear (default) 1 = Exponential	00 = Brightness Register Only 01 = PWM Duty Cycle Only 10 = Multiply Then Ramp (Brightness Register x PWM) 11 = Ramp Then Multiply (Brightness Register x PWM) (default)	0 = Ramp Disabled (default) 1 = Ramp Enabled	000 = 0.125 ms/step (default) 001 = 0.250 ms/step 010 = 0.5 ms/step 011 = 1 ms/step 100 = 2 ms/step 101 = 4 ms/step 110 = 8 ms/step 111 = 16 ms/step	R

Table 12. PWM Control (0x12)

PWM Sample Rate Bit [7:6]	PWM Input Polarity Bit [5]	PWM Hysteresis Bits [4:2]	PWM Pulse Filter Bit [1:0]
00 = 800 kHz 01 = 4 MHz 1X = 24 MHz (default)	0 = Active Low 1 = Active High (default)	000 = None 001 = 1 LSB 010 = 2 LSBs 011 = 3 LSBs 100 = 4 LSBs (default) 101 = 5 LSBs 110 = 6 LSBs 111 = N/A	00 = No Filter 01 = 100 ns 10 = 150 ns 11 = 200 ns (default)

Table 13. Boost Control 1 (0x13)

Reserved Bit [7]	Boost Switching Frequency Shift Bit [6]	Boost Switching Frequency Select Bit [5]	Minimum Inductor Select Bit [4]	Overvoltage Protection (OVP) Bits [3:2]	Current Limit (OCP) Bits [1:0]
N/A	0 = –12% Shift 1 = No Shift (default)	0 = 500 kHz 1 = 1 MHz (default)	0 = 4.7 μ H (default) 1 = 10 μ H	00 = 17 V 01 = 24 V 10 = 31 V 11 = 38 V (default)	00 = 750 mA 01 = 1000 mA 10 = 1250 mA 11 = 1500 mA (default)

Table 14. Auto Frequency High Threshold (0x15)

Auto Frequency High Threshold (500 kHz to 1000 kHz) Bits [7:0]
Compared against the 8 MSBs of 11-bit brightness code (default = 00000000).

Table 15. Auto Frequency Low Threshold (0x16)

Auto Frequency High Threshold (250 kHz to 500 kHz) Bits [7:0]
Compared against the 8 MSBs of 11-bit brightness code (default = 00000000).

Table 16. Brightness Register LSBs (0x18)

Bits [7:3]	I ² C Brightness Code (LSB) Bits [2:0]
R	This is the lower 3 bits of the 11-bit brightness code (default = 111).

Table 17. Brightness Register MSBs (0x19)

I ² C Brightness Code (MSB) Bits [7:0]
This is the upper 8 bits of the 11-bit brightness code (default = 11111111).

Table 18. Fault Control (0x1E)

Reserved Bits [7:4]	LED Short Fault Enable Bit [3]	TSD Shutdown Disable Bit [2]	OCP Shutdown Disable Bit [1]	OVP/LED Open Shutdown Disable Bit [0]
R	0 = LED Short Fault Detection is disabled (default). 1 = LED Short Fault Detection is enabled	0 = When the TSD Flag is set, the device is forced into shutdown. 1 = No shutdown (default)	0 = When the OCP Flag is set, the device is forced into shutdown. 1 = No shutdown (default)	0 = When the OVP Flag is set, the device is forced into shutdown. 1 = No shutdown (default)

Table 19. Fault Flags (0x1F)

Reserved Bits [7:5]	LED Open Fault Bit [4]	LED Short Fault Bit [3]	TSD Fault Bit [2]	OCP Fault Bit [1]	OVP Fault Bit [0]
R	1 = LED String Open Fault	1 = LED Short Fault	1 = Thermal Shutdown Fault	1 = Current Limit Fault	1 = Output Overvoltage Fault

8 Applications and Implementation

NOTE

Information in the following applications sections is not part of the TI component specification, and TI does not warrant its accuracy or completeness. TI's customers are responsible for determining suitability of components for their purposes. Customers should validate and test their design implementation to confirm system functionality.

8.1 Application Information

The LM36922H provides a complete high-performance LED lighting solution for mobile handsets. The LM36922H is highly configurable and can support multiple LED configurations.

8.2 Typical Application

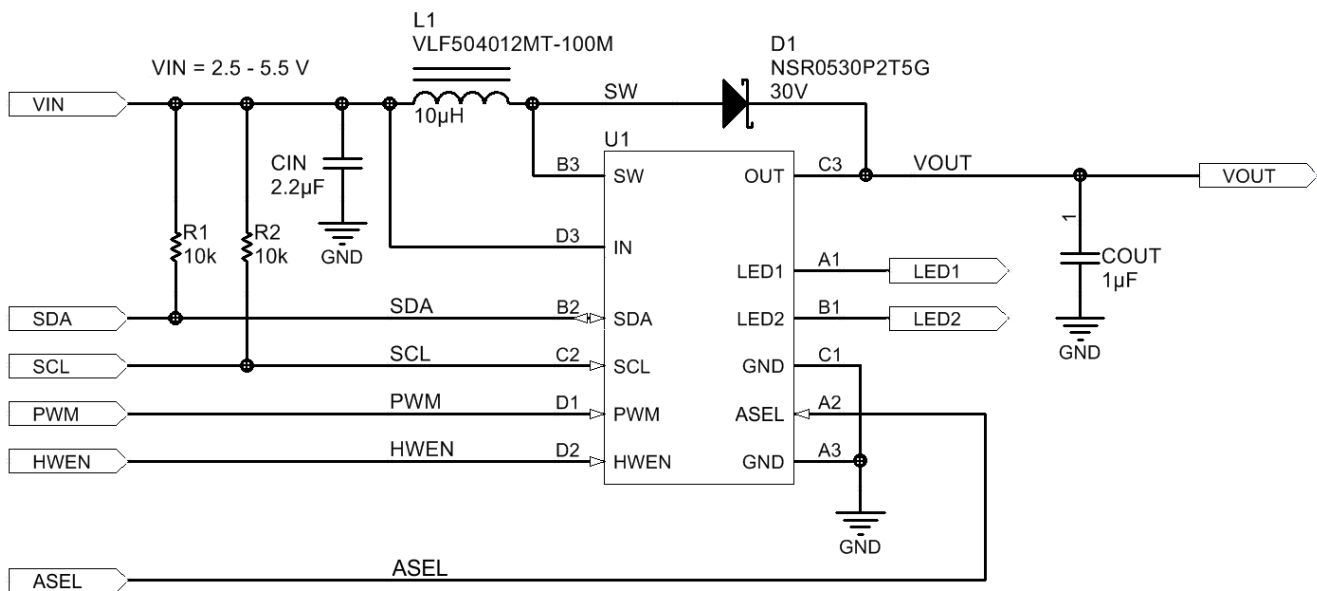

Figure 30. LM36922H Typical Application

8.2.1 Design Requirements

DESIGN PARAMETER	EXAMPLE VALUE
Minimum input voltage (V_{IN})	2.7 V
LED parallel/series configuration	2 × 8
LED maximum forward voltage (V_f)	3.2 V
Efficiency	80%

The number of LED strings, number of series LEDs, and minimum input voltage are needed in order to calculate the peak input current. This information guides the designer to make the appropriate inductor selection for the application. The LM36922H boost converter output voltage (V_{OUT}) is calculated: number of series LEDs × V_f + 0.23 V. The LM36922H boost converter output current (I_{OUT}) is calculated: number of parallel LED strings × 25 mA. The LM36922H peak input current is calculated using Equation 5.

8.2.2 Detailed Design Procedure

8.2.2.1 Component Selection

8.2.2.1.1 Inductor

The LM36922H requires a typical inductance in the range of 4.7 μH to 10 μH . When selecting the inductor, ensure that the saturation rating for the inductor is high enough to accommodate the peak inductor current of the application (I_{PEAK}) given in the inductor datasheet. The peak inductor current occurs at the maximum load current, the maximum output voltage, the minimum input voltage, and the minimum switching frequency setting. Also, the peak current requirement increases with decreasing efficiency. I_{PEAK} can be estimated using Equation 5:

$$I_{PEAK} = \frac{V_{OUT} \times I_{OUT}}{V_{IN} \times \eta} + \frac{V_{IN}}{2 \times f_{SW} \times L} \times \left(1 + \frac{V_{IN} \times \eta}{V_{OUT}}\right) \quad (5)$$

Also, the peak current calculated above is different from the peak inductor current setting (I_{SAT}). The NMOS switch current limit setting (I_{CL_MIN}) must be greater than I_{PEAK} from Equation 5 above.

8.2.2.1.2 Output Capacitor

The LM36922H requires a ceramic capacitor with a minimum of 0.4 μF of capacitance at the output, specified over the entire range of operation. This ensures that the device remains stable and oscillation free. The 0.4 μF of capacitance is the minimum amount of capacitance, which is different than the value of capacitor. Capacitance would take into account tolerance, temperature, and DC voltage shift.

Table 20 lists possible output capacitors that can be used with the LM36922H. Figure 31 shows the DC bias of the four TDK capacitors. The useful voltage range is determined from the effective output voltage range for a given capacitor as determined by Equation 6:

$$DC \text{ Voltage Derating} \geq \frac{0.38\mu\text{F}}{(1 - Tol) \times (1 - Temp_co)} \quad (6)$$

Table 20. Recommended Output Capacitors

PART NUMBER	MANUFACTURER	CASE SIZE	VOLTAGE RATING (V)	NOMINAL CAPACITANCE (μF)	TOLERANCE (%)	TEMPERATURE COEFFICIENT (%)	RECOMMENDED MAX OUTPUT VOLTAGE (FOR SINGLE CAPACITOR)
C2012X5R1H105K085AB	TDK	0805	50	1	± 10	± 15	22
C2012X5R1H225K085AB	TDK	0805	50	2.2	± 10	± 15	24
C1608X5R1V225K080AC	TDK	0603	35	2.2	± 10	± 15	12
C1608X5R1H105K080AB	TDK	0603	50	1	± 10	± 15	15

For example, with a 10% tolerance, and a 15% temperature coefficient, the DC voltage derating must be $\geq 0.38 / (0.9 \times 0.85) = 0.5 \mu\text{F}$. For the C1608X5R1H225K080AB (0603, 50-V) device, the useful voltage range occurs up to the point where the DC bias derating falls below 0.523 μF , or around 12 V. For configurations where V_{OUT} is > 15 V, two of these capacitors can be paralleled, or a larger capacitor such as the C2012X5R1H105K085AB must be used.

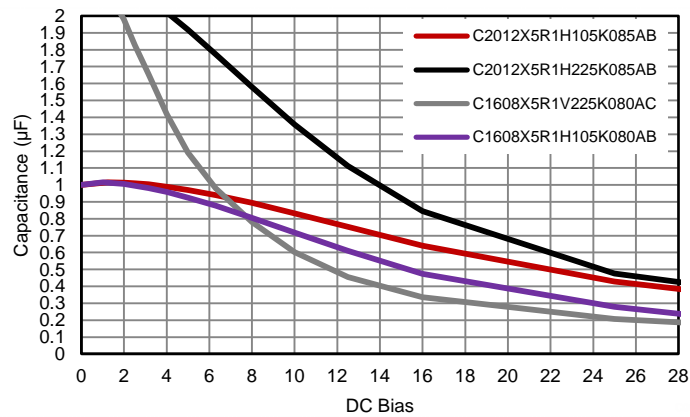

Figure 31. DC Bias Derating for 0805 Case Size and 0603 Case Size 35-V and 50-V Ceramic Capacitors

8.2.2.1.3 Input Capacitor

The input capacitor in a boost is not as critical as the output capacitor. The input capacitor primary function is to filter the switching supply currents at the device input and to filter the inductor current ripple at the input of the inductor. The recommended input capacitor is a 2.2-µF ceramic (0402, 10-V device) or equivalent.

8.2.3 Application Curves

L1 = 4.7 μ H (VLF504012-4R7M) or 10 μ H (VLF504015-100M) as noted in graphs, D1 = NSR240P2T5G, LEDs are Samsung SPMWHT325AD5YBTMS0, temperature = 25°C, V_{IN} = 3.7 V, unless otherwise noted.

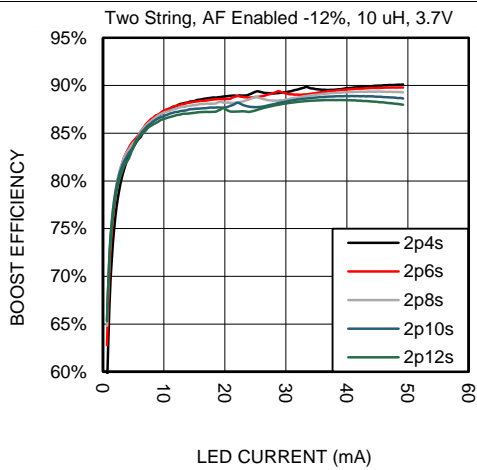

Figure 32. Boost Efficiency vs Series LEDs

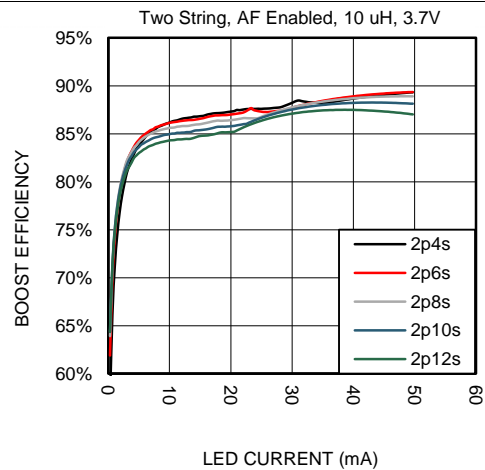

Figure 33. Boost Efficiency vs Series LEDs

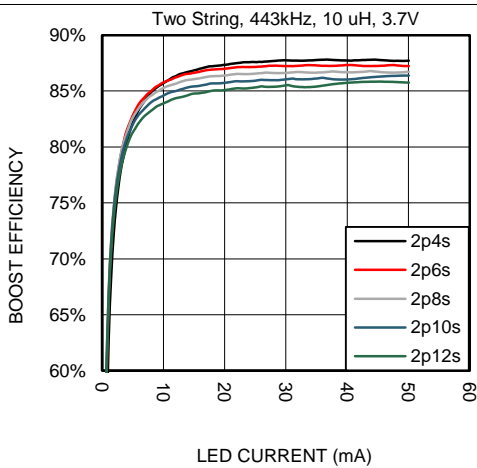

Figure 34. Boost Efficiency vs Series LEDs

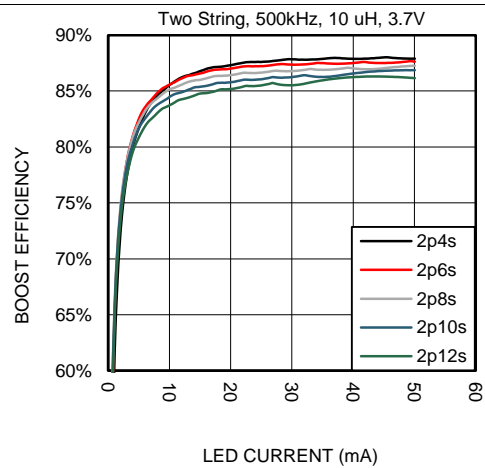

Figure 35. Boost Efficiency vs Series LEDs

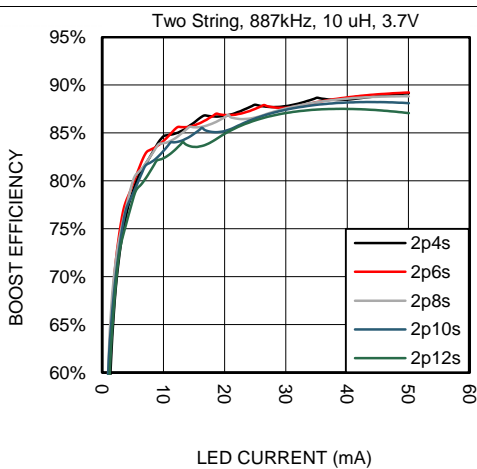

Figure 36. Boost Efficiency vs Series LEDs

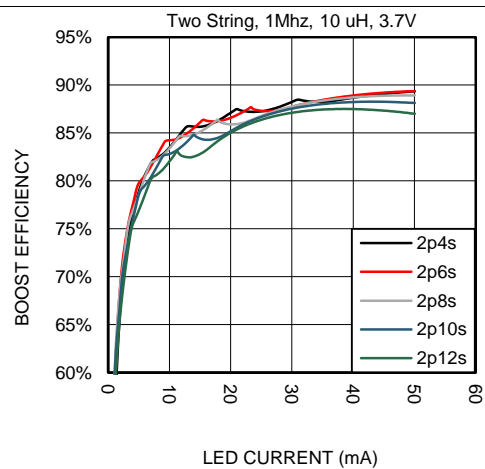

Figure 37. Boost Efficiency vs Series LEDs

L1 = 4.7 μ H (VLF504012-4R7M) or 10 μ H (VLF504015-100M) as noted in graphs, D1 = NSR240P2T5G, LEDs are Samsung SPMWHT325AD5YBTMS0, temperature = 25°C, V_{IN} = 3.7 V, unless otherwise noted.

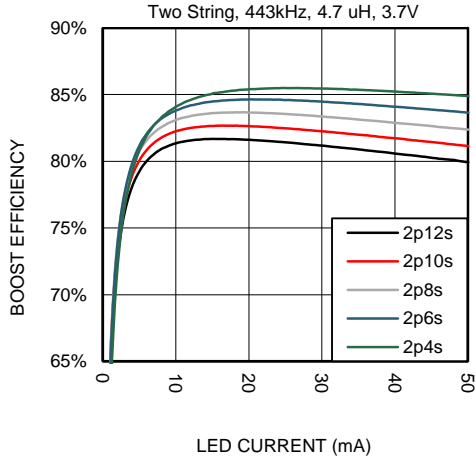

Figure 38. Boost Efficiency vs Series LEDs

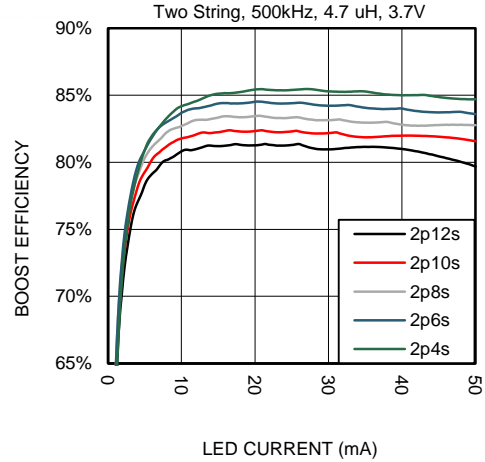

Figure 39. Boost Efficiency vs Series LEDs

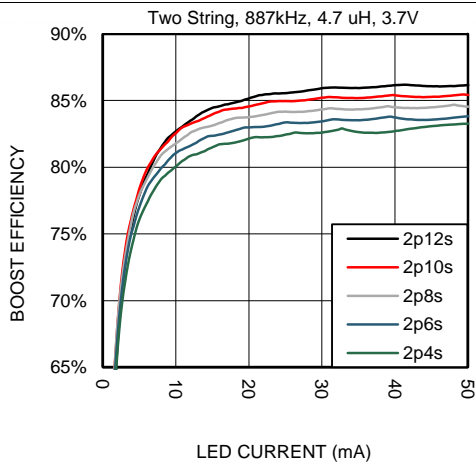

Figure 40. Boost Efficiency vs Series LEDs

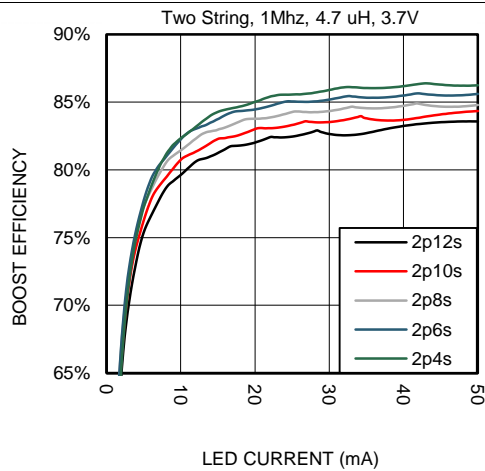

Figure 41. Boost Efficiency vs Series LEDs

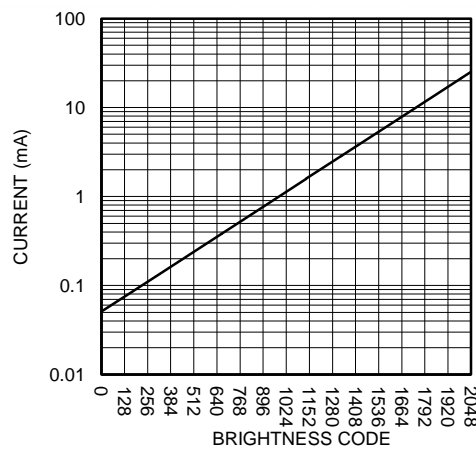

Figure 42. LED Current vs Brightness Code (Exponential Mapping)

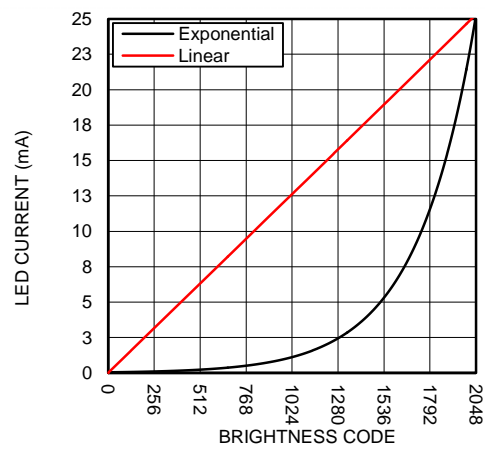

Figure 43. LED Current vs Brightness Code

L1 = 4.7 μ H (VLF504012-4R7M) or 10 μ H (VLF504015-100M) as noted in graphs, D1 = NSR240P2T5G, LEDs are Samsung SPMWHT325AD5YBTMS0, temperature = 25°C, V_{IN} = 3.7 V, unless otherwise noted.

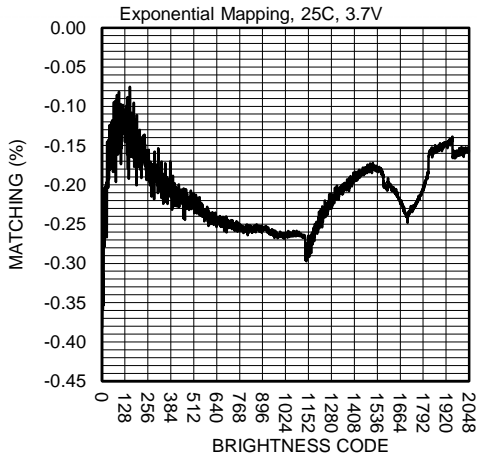

Figure 44. LED Matching (Exponential Mapping)

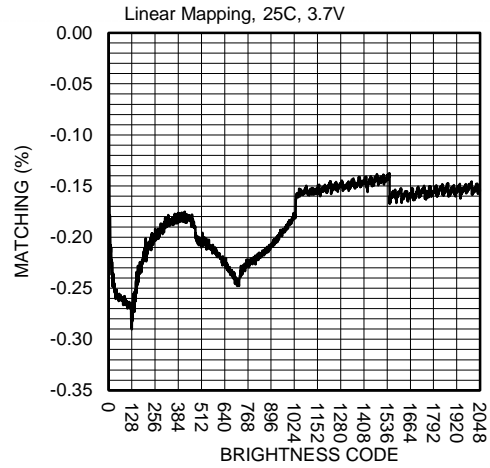

Figure 45. LED Matching (Linear Mapping)

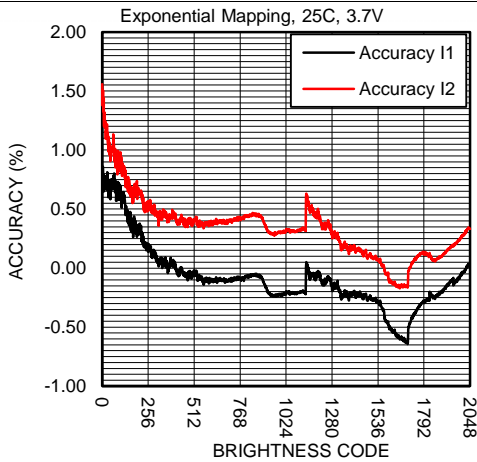

Figure 46. LED Current Accuracy

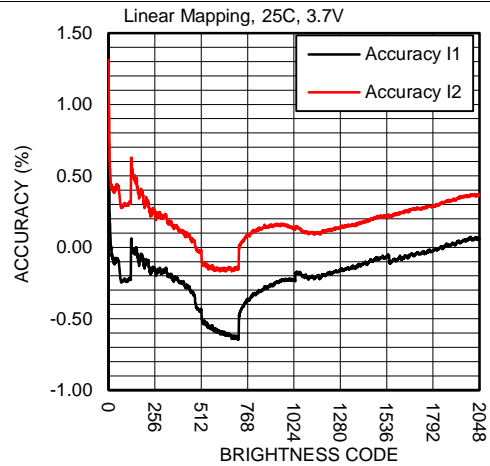

Figure 47. LED Current Accuracy

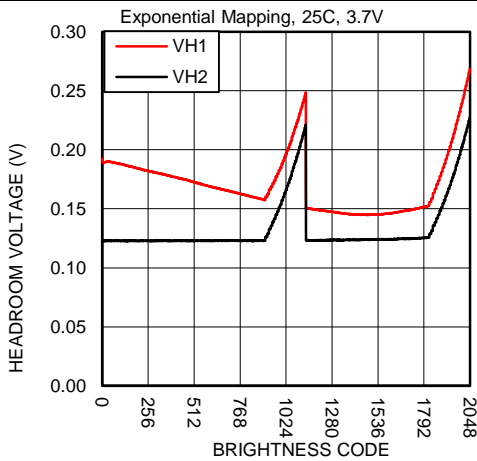

Figure 48. LED Headroom Voltage (Mis-Matched Strings)

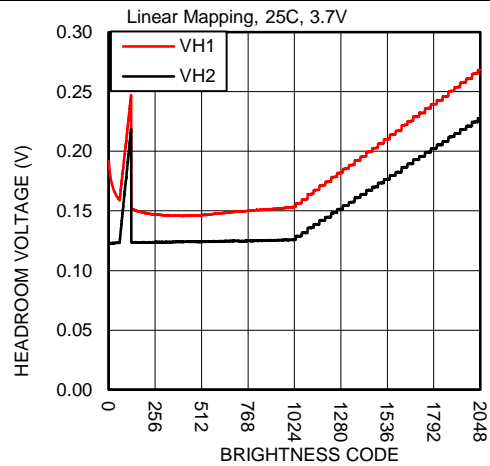

Figure 49. LED Headroom Voltage (Mis-Matched Strings)

L1 = 4.7 μ H (VLF504012-4R7M) or 10 μ H (VLF504015-100M) as noted in graphs, D1 = NSR240P2T5G, LEDs are Samsung SPMWHT325AD5YBTMS0, temperature = 25°C, V_{IN} = 3.7 V, unless otherwise noted.

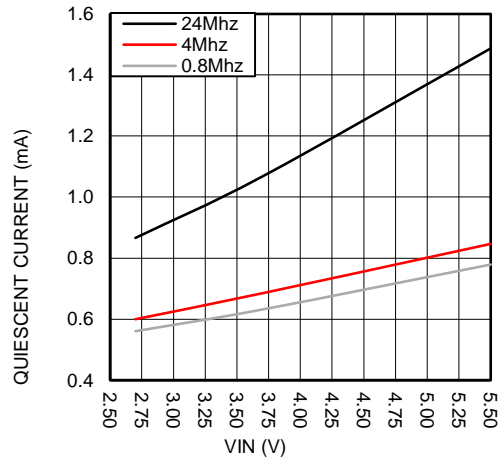

Figure 50. Current vs PWM Sample Frequency

9 Power Supply Recommendations

9.1 Input Supply Bypassing

The LM36922H is designed to operate from an input supply range of 2.5 V to 5.5 V. This input supply should be well regulated and be able to provide the peak current required by the LED configuration and inductor selected without voltage drop under load transients (start-up or rapid brightness change). The resistance of the input supply rail should be low enough such that the input current transient does not cause the LM36922H supply voltage to droop more than 5%. Additional bulk decoupling located close to the input capacitor (C_{IN}) may be required to minimize the impact of the input supply rail resistance.

10 Layout

10.1 Layout Guidelines

The inductive boost converter of the LM36922H device detects a high switched voltage (up to V_{OVP}) at the SW pin, and a step current (up to I_{CL}) through the Schottky diode and output capacitor each switching cycle. The high switching voltage can create interference into nearby nodes due to electric field coupling ($I = CdV/dt$). The large step current through the diode and the output capacitor can cause a large voltage spike at the SW pin and the OUT pin due to parasitic inductance in the step current conducting path ($V = Ldi/dt$). Board layout guidelines are geared towards minimizing this electric field coupling and conducted noise. Figure 51 highlights these two noise-generating components.

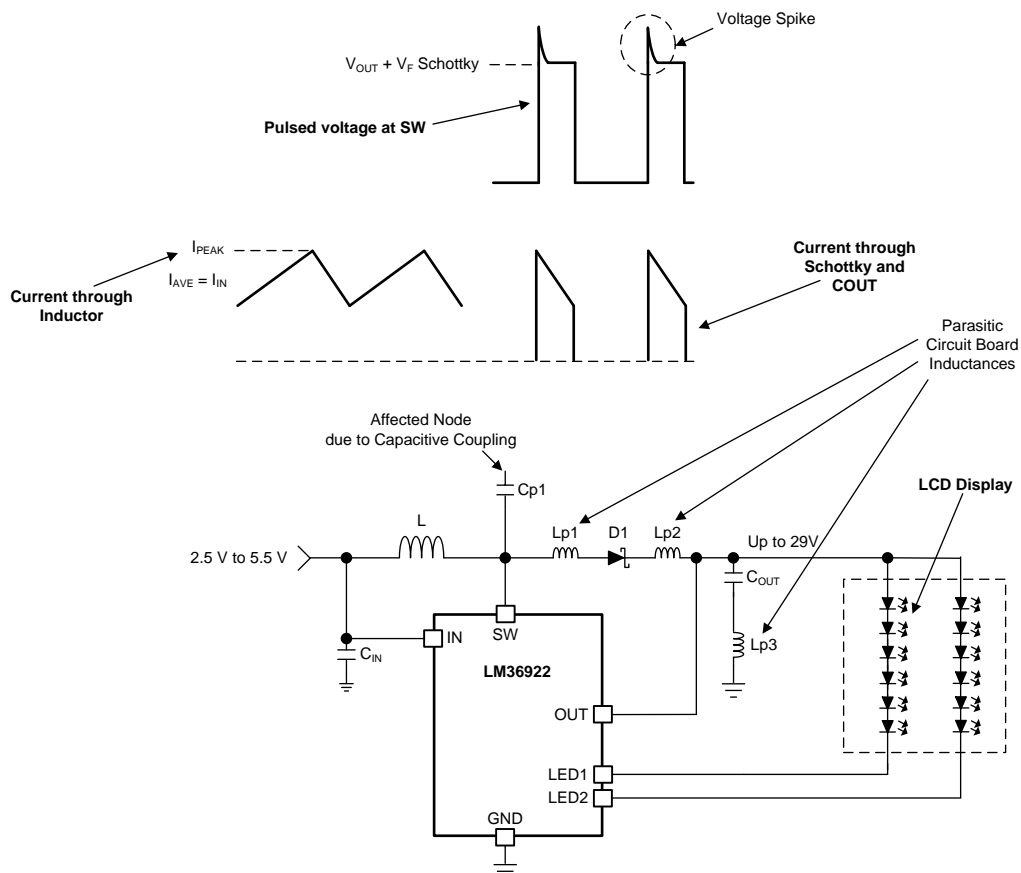

Figure 51. SW Pin Voltage (High dV/dt) and Current Through Schottky Diode and C_{OUT} (High dI/dt)

Layout Guidelines (continued)

The following list details the main (layout sensitive) areas of the inductive boost converter of the LM36922H device in order of decreasing importance:

- Output Capacitor
 - Schottky Cathode to COUT+
 - COUT– to GND
- Schottky Diode
 - SW pin to Schottky Anode
 - Schottky Cathode to COUT+
- Inductor
 - SW Node PCB capacitance to other traces
- Input Capacitor
 - CIN+ to IN pin

10.1.1 Boost Output Capacitor Placement

Because the output capacitor is in the path of the inductor current discharge path it detects a high-current step from 0 to I_{PEAK} each time the switch turns off and the Schottky diode turns on. Any inductance along this series path from the cathode of the diode through C_{OUT} and back into the GND pin of the LM36922H device GND pin contributes to voltage spikes ($V_{SPIKE} = L_P \times di/dt$) at SW and OUT. These spikes can potentially over-voltage the SW pin, or feed through to GND. To avoid this, COUT+ must be connected as close to the cathode of the Schottky diode as possible, and COUT– must be connected as close to the GND pin of the device as possible. The best placement for COUT is on the same layer as the LM36922H in order to avoid any vias that can add excessive series inductance.

10.1.2 Schottky Diode Placement

In the boost circuit of the LM36922H device the Schottky diode is in the path of the inductor current discharge. As a result the Schottky diode sees a high-current step from 0 to I_{PEAK} each time the switch turns off and the diode turns on. Any inductance in series with the diode causes a voltage spike ($V_{SPIKE} = L_P \times di/dt$) at SW and OUT. This can potentially over-voltage the SW pin, or feed through to V_{OUT} and through the output capacitor and into GND. Connecting the anode of the diode as close to the SW pin as possible and the cathode of the diode as close to C_{OUT} as possible reduces the inductance (L_P) and minimize these voltage spikes.

10.1.3 Inductor Placement

The node where the inductor connects to the LM36922H device SW pin has 2 issues. First, a large switched voltage (0 to $V_{OUT} + V_{F_SCHOTTKY}$) appears on this node every switching cycle. This switched voltage can be capacitively coupled into nearby nodes. Second, there is a relatively large current (input current) on the traces connecting the input supply to the inductor and connecting the inductor to the SW bump. Any resistance in this path can cause voltage drops that can negatively affect efficiency and reduce the input operating voltage range.

To reduce the capacitive coupling of the signal on SW into nearby traces, the SW bump-to-inductor connection must be minimized in area. This limits the PCB capacitance from SW to other traces. Additionally, high impedance nodes that are more susceptible to electric field coupling must be routed away from SW and not directly adjacent or beneath. This is especially true for traces such as SCL, SDA, HWEN, ASEL, and PWM. A GND plane placed directly below SW dramatically reduces the capacitance from SW into nearby traces.

Lastly, limit the trace resistance of the V_{IN} to inductor connection and from the inductor to SW connection by use of short, wide traces.

10.1.4 Boost Input Capacitor Placement

For the LM36922H boost converter, the input capacitor filters the inductor current ripple and the internal MOSFET driver currents during turnon of the internal power switch. The driver current requirement can range from 50 mA at 2.7 V to over 200 mA at 5.5 V with fast durations of approximately 10 ns to 20 ns. This appears as high di/dt current pulses coming from the input capacitor each time the switch turns on. Close placement of the input capacitor to the IN pin and to the GND pin is critical because any series inductance between IN and CIN+ or CIN– and GND can create voltage spikes that could appear on the VIN supply line and in the GND

Layout Guidelines (continued)

plane. Close placement of the input bypass capacitor at the input side of the inductor is also critical. The source impedance (inductance and resistance) from the input supply, along with the input capacitor of the LM36922H, form a series RLC circuit. If the output resistance from the source (R_S) is low enough the circuit is underdamped and has a resonant frequency (typically the case). Depending on the size of L_S the resonant frequency could occur below, close to, or above the LM36922H switching frequency. This can cause the supply current ripple to be:

1. Approximately equal to the inductor current ripple when the resonant frequency occurs well above the LM36922H switching frequency;
2. Greater than the inductor current ripple when the resonant frequency occurs near the switching frequency; or
3. Less than the inductor current ripple when the resonant frequency occurs well below the switching frequency.

Figure 52 shows the series RLC circuit formed from the output impedance of the supply and the input capacitor. The circuit is redrawn for the AC case where the V_{IN} supply is replaced with a short to GND, and the LM36922H + Inductor is replaced with a current source (ΔI_L). Equation 1 is the criteria for an underdamped response. Equation 2 is the resonant frequency. Equation 3 is the approximated supply current ripple as a function of L_S , R_S , and C_{IN} . As an example, consider a 3.6-V supply with 0.1 Ω of series resistance connected to C_{IN} through 50 nH of connecting traces. This results in an underdamped input-filter circuit with a resonant frequency of 712 kHz. Because both the 1-MHz and 500-kHz switching frequency options lie close to the resonant frequency of the input filter, the supply current ripple is probably larger than the inductor current ripple. In this case, using equation 3, the supply current ripple can be approximated as 1.68 times the inductor current ripple (using a 500-kHz switching frequency) and 0.86 times the inductor current ripple using a 1-MHz switching frequency. Increasing the series inductance (L_S) to 500 nH causes the resonant frequency to move to around 225 kHz, and the supply current ripple to be approximately 0.25 times the inductor current ripple (500-kHz switching frequency) and 0.053 times for a 1-MHz switching frequency.

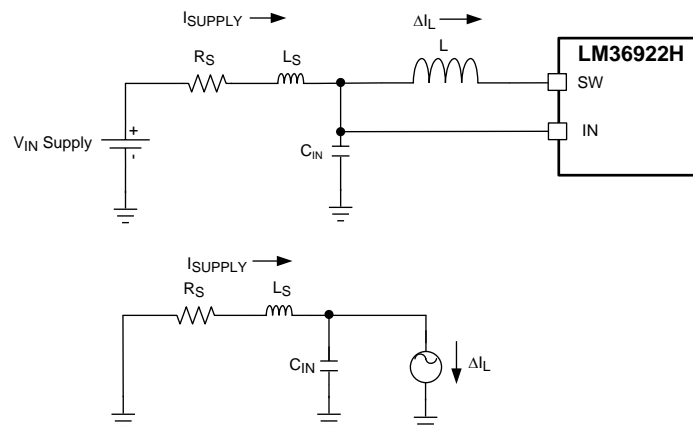

$$1. \frac{1}{L_S \times C_{IN}} > \frac{R_S^2}{4 \times L_S^2}$$

$$2. f_{RESONANT} = \frac{1}{2\pi\sqrt{L_S \times C_{IN}}}$$

$$3. I_{SUPPLYRIPPLE} \approx \Delta I_L \times \frac{1}{\sqrt{R_S^2 + \left(2\pi \times 500 \text{ kHz} \times L_S - \frac{1}{2\pi \times 500 \text{ kHz} \times C_{IN}}\right)^2}}$$

Figure 52. Input RLC Network

10.2 Layout Example

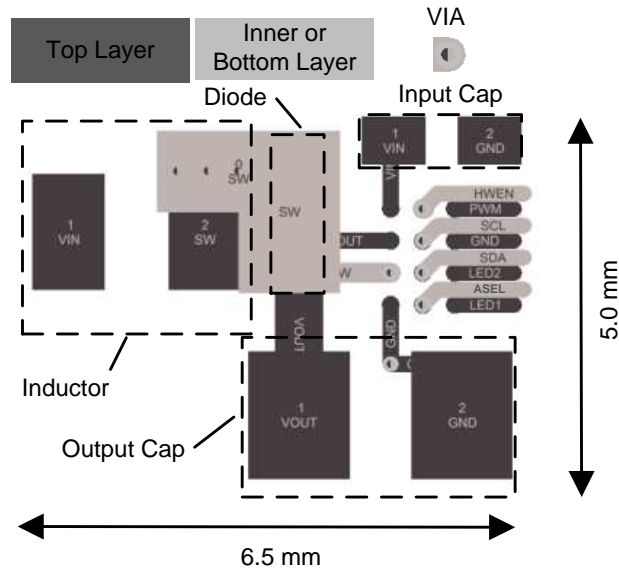

Figure 53. LM36922H Layout Example

11 器件和文档支持

11.1 器件支持

11.1.1 Third-Party Products Disclaimer

TI'S PUBLICATION OF INFORMATION REGARDING THIRD-PARTY PRODUCTS OR SERVICES DOES NOT CONSTITUTE AN ENDORSEMENT REGARDING THE SUITABILITY OF SUCH PRODUCTS OR SERVICES OR A WARRANTY, REPRESENTATION OR ENDORSEMENT OF SUCH PRODUCTS OR SERVICES, EITHER ALONE OR IN COMBINATION WITH ANY TI PRODUCT OR SERVICE.

11.2 商标

E2E is a trademark of Texas Instruments.
All other trademarks are the property of their respective owners.

11.3 社区资源

The following links connect to TI community resources. Linked contents are provided "AS IS" by the respective contributors. They do not constitute TI specifications and do not necessarily reflect TI's views; see TI's [Terms of Use](#).

TI E2E™ Online Community *TI's Engineer-to-Engineer (E2E) Community*. Created to foster collaboration among engineers. At e2e.ti.com, you can ask questions, share knowledge, explore ideas and help solve problems with fellow engineers.

Design Support *TI's Design Support* Quickly find helpful E2E forums along with design support tools and contact information for technical support.

11.4 静电放电警告



ESD 可能会损坏该集成电路。德州仪器 (TI) 建议通过适当的预防措施处理所有集成电路。如果不遵守正确的处理措施和安装程序，可能会损坏集成电路。

ESD 的损坏小至导致微小的性能降级，大至整个器件故障。精密的集成电路可能更容易受到损坏，这是因为非常细微的参数更改都可能会导致器件与其发布的规格不相符。

11.5 Glossary

[SLYZ022](#) — *TI Glossary*.

This glossary lists and explains terms, acronyms, and definitions.

12 机械、封装和可订购信息

以下页中包括机械、封装和可订购信息。这些信息是针对指定器件可提供的最新数据。这些数据会在无通知且不对本文档进行修订的情况下发生改变。欲获得该数据表的浏览器版本，请查阅左侧的导航栏。

PACKAGING INFORMATION

Orderable Device	Status (1)	Package Type	Package Drawing	Pins	Package Qty	Eco Plan (2)	Lead finish/ Ball material (6)	MSL Peak Temp (3)	Op Temp (°C)	Device Marking (4/5)	Samples
LM36922HYFFR	ACTIVE	DSBGA	YFF	12	3000	RoHS & Green	SNAGCU	Level-1-260C-UNLIM	-40 to 85	36922H	Samples

(1) The marketing status values are defined as follows:

ACTIVE: Product device recommended for new designs.

LIFEBUY: TI has announced that the device will be discontinued, and a lifetime-buy period is in effect.

NRND: Not recommended for new designs. Device is in production to support existing customers, but TI does not recommend using this part in a new design.

PREVIEW: Device has been announced but is not in production. Samples may or may not be available.

OBSOLETE: TI has discontinued the production of the device.

(2) **RoHS:** TI defines "RoHS" to mean semiconductor products that are compliant with the current EU RoHS requirements for all 10 RoHS substances, including the requirement that RoHS substance do not exceed 0.1% by weight in homogeneous materials. Where designed to be soldered at high temperatures, "RoHS" products are suitable for use in specified lead-free processes. TI may reference these types of products as "Pb-Free".

RoHS Exempt: TI defines "RoHS Exempt" to mean products that contain lead but are compliant with EU RoHS pursuant to a specific EU RoHS exemption.

Green: TI defines "Green" to mean the content of Chlorine (Cl) and Bromine (Br) based flame retardants meet JS709B low halogen requirements of <=1000ppm threshold. Antimony trioxide based flame retardants must also meet the <=1000ppm threshold requirement.

(3) MSL, Peak Temp. - The Moisture Sensitivity Level rating according to the JEDEC industry standard classifications, and peak solder temperature.

(4) There may be additional marking, which relates to the logo, the lot trace code information, or the environmental category on the device.

(5) Multiple Device Markings will be inside parentheses. Only one Device Marking contained in parentheses and separated by a "-" will appear on a device. If a line is indented then it is a continuation of the previous line and the two combined represent the entire Device Marking for that device.

(6) Lead finish/Ball material - Orderable Devices may have multiple material finish options. Finish options are separated by a vertical ruled line. Lead finish/Ball material values may wrap to two lines if the finish value exceeds the maximum column width.

Important Information and Disclaimer: The information provided on this page represents TI's knowledge and belief as of the date that it is provided. TI bases its knowledge and belief on information provided by third parties, and makes no representation or warranty as to the accuracy of such information. Efforts are underway to better integrate information from third parties. TI has taken and continues to take reasonable steps to provide representative and accurate information but may not have conducted destructive testing or chemical analysis on incoming materials and chemicals. TI and TI suppliers consider certain information to be proprietary, and thus CAS numbers and other limited information may not be available for release.

In no event shall TI's liability arising out of such information exceed the total purchase price of the TI part(s) at issue in this document sold by TI to Customer on an annual basis.

TAPE AND REEL INFORMATION

QUADRANT ASSIGNMENTS FOR PIN 1 ORIENTATION IN TAPE

*All dimensions are nominal

Device	Package Type	Package Drawing	Pins	SPQ	Reel Diameter (mm)	Reel Width W1 (mm)	A0 (mm)	B0 (mm)	K0 (mm)	P1 (mm)	W (mm)	Pin1 Quadrant
LM36922HYFFR	DSBGA	YFF	12	3000	180.0	8.4	1.5	1.99	0.75	4.0	8.0	Q1

TAPE AND REEL BOX DIMENSIONS

*All dimensions are nominal

Device	Package Type	Package Drawing	Pins	SPQ	Length (mm)	Width (mm)	Height (mm)
LM36922HYFFR	DSBGA	YFF	12	3000	210.0	185.0	35.0

YFF0012

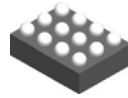

PACKAGE OUTLINE

DSBGA - 0.625 mm max height

DIE SIZE BALL GRID ARRAY

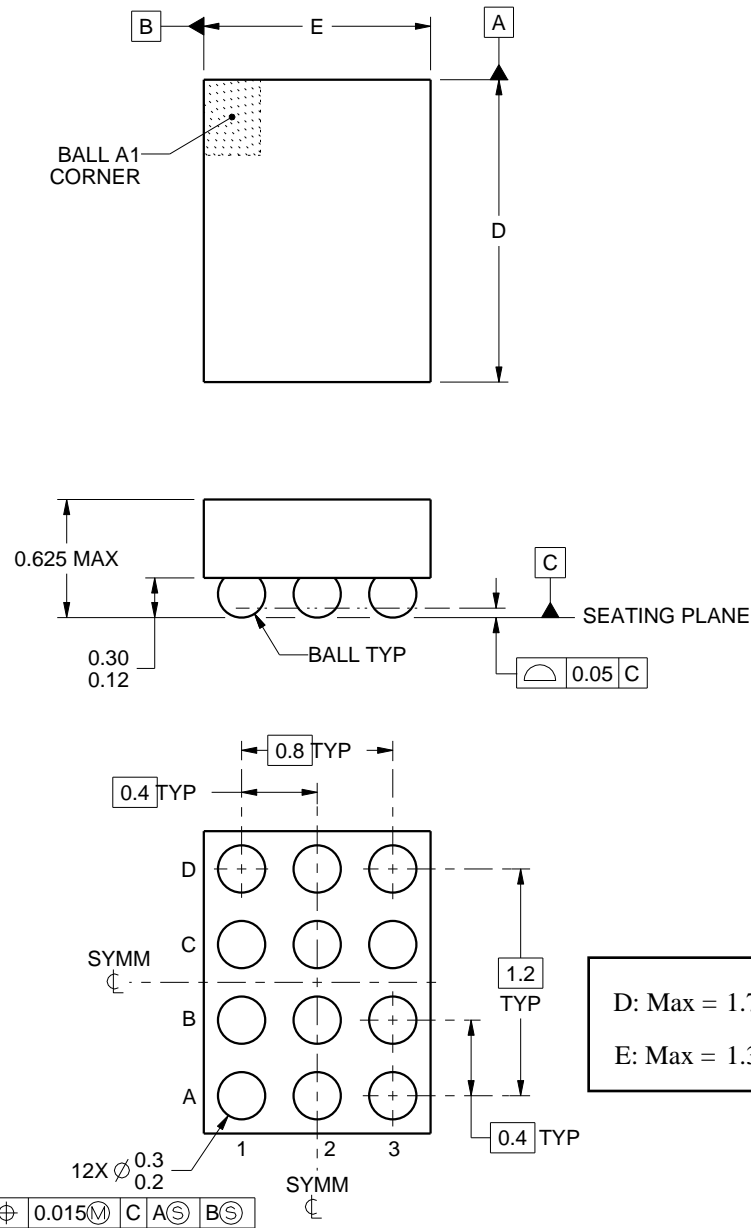

D: Max = 1.756 mm, Min = 1.695 mm
 E: Max = 1.355 mm, Min = 1.295 mm

4222191/A 07/2015

NOTES:

1. All linear dimensions are in millimeters. Any dimensions in parenthesis are for reference only. Dimensioning and tolerancing per ASME Y14.5M.
2. This drawing is subject to change without notice.

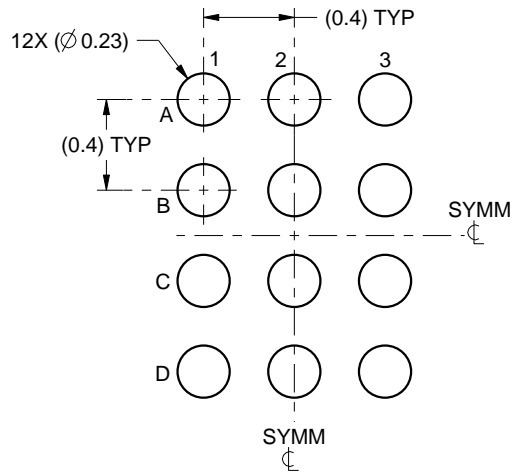

LAND PATTERN EXAMPLE
SCALE:30X

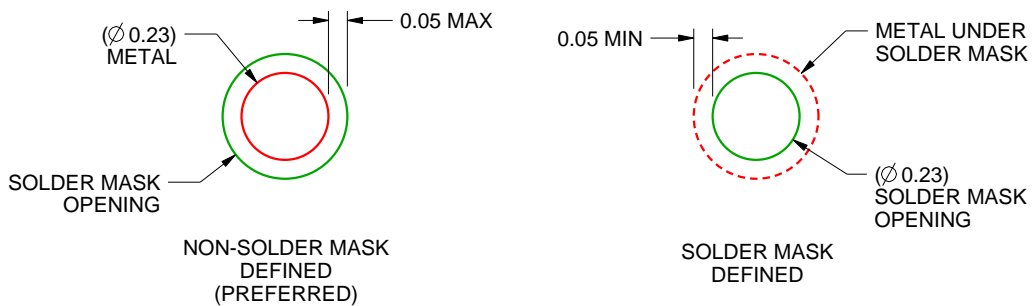

SOLDER MASK DETAILS
NOT TO SCALE

4222191/A 07/2015

NOTES: (continued)

3. Final dimensions may vary due to manufacturing tolerance considerations and also routing constraints. For more information, see Texas Instruments literature number SNVA009 (www.ti.com/lit/snva009).

EXAMPLE STENCIL DESIGN

YFF0012

DSBGA - 0.625 mm max height

DIE SIZE BALL GRID ARRAY

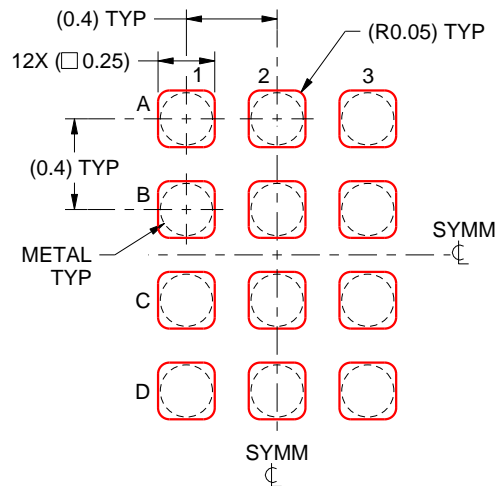

SOLDER PASTE EXAMPLE
BASED ON 0.1 mm THICK STENCIL
SCALE:30X

4222191/A 07/2015

NOTES: (continued)

4. Laser cutting apertures with trapezoidal walls and rounded corners may offer better paste release.

重要声明和免责声明

TI“按原样”提供技术和可靠性数据（包括数据表）、设计资源（包括参考设计）、应用或其他设计建议、网络工具、安全信息和其他资源，不保证没有瑕疵且不做任何明示或暗示的担保，包括但不限于对适销性、某特定用途方面的适用性或不侵犯任何第三方知识产权的暗示担保。

这些资源可供使用 TI 产品进行设计的熟练开发人员使用。您将自行承担以下全部责任：(1) 针对您的应用选择合适的 TI 产品，(2) 设计、验证并测试您的应用，(3) 确保您的应用满足相应标准以及任何其他功能安全、信息安全、监管或其他要求。

这些资源如有变更，恕不另行通知。TI 授权您仅可将这些资源用于研发本资源所述的 TI 产品的应用。严禁对这些资源进行其他复制或展示。您无权使用任何其他 TI 知识产权或任何第三方知识产权。您应全额赔偿因在这些资源的使用中对 TI 及其代表造成的任何索赔、损害、成本、损失和债务，TI 对此概不负责。

TI 提供的产品受 [TI 的销售条款](#) 或 [ti.com](#) 上其他适用条款/TI 产品随附的其他适用条款的约束。TI 提供这些资源并不会扩展或以其他方式更改 TI 针对 TI 产品发布的适用的担保或担保免责声明。

TI 反对并拒绝您可能提出的任何其他或不同的条款。

邮寄地址：Texas Instruments, Post Office Box 655303, Dallas, Texas 75265

Copyright © 2023，德州仪器 (TI) 公司