

LM7341 Rail-to-Rail Input/Output $\pm 15V$, 4.6 MHz GBW, Operational Amplifier in SOT-23 Package

Check for Samples: [LM7341](#)

FEATURES

- ($V_S = \pm 15V$, $T_A = 25^\circ C$, Typical Values.)
- **Tiny 5-pin SOT-23 Package Saves Space**
- **Greater than Rail-to-Rail Input CMVR $-15.3V$ to $15.3V$**
- **Rail-to-Rail Output Swing $-14.84V$ to $14.86V$**
- **Supply Current 0.7 mA**
- **Gain Bandwidth 4.6 MHz**
- **Slew Rate 1.9 V/ μs**
- **Wide Supply Range 2.7V to 32V**
- **High Power Supply Rejection Ratio 106 dB**
- **High Common Mode Rejection Ratio 115 dB**
- **Excellent Gain 106 dB**
- **Temperature Range $-40^\circ C$ to $125^\circ C$**
- **Tested at $-40^\circ C$, $125^\circ C$ and $25^\circ C$ at 2.7V, $\pm 5V$ and $\pm 15V$**

APPLICATIONS

- **Automotive**
- **Industrial Robotics**
- **Sensor Output Buffers**
- **Multiple Voltage Power Supplies**
- **Reverse Biasing of Photodiodes**
- **Low Current Optocouplers**
- **High Side Sensing**
- **Comparator**
- **Battery Chargers**
- **Test Point Output Buffers**
- **Below Ground Current Sensing**

DESCRIPTION

The LM7341 is a rail-to-rail input and output amplifier in a small SOT-23 package with a wide supply voltage and temperature range. The LM7341 has a 4.6 MHz gain bandwidth and a 1.9 volt per microsecond slew rate, and draws 0.75 mA of supply current at no load.

The LM7341 is tested at $-40^\circ C$, $125^\circ C$ and $25^\circ C$ with modern automatic test equipment. Detailed performance specifications at 2.7V, $\pm 5V$, and $\pm 15V$ and over a wide temperature range make the LM7341 a good choice for automotive, industrial, and other demanding applications.

Greater than rail-to-rail input common mode range with a minimum 76 dB of common mode rejection at $\pm 15V$ makes the LM7341 a good choice for both high and low side sensing applications.

LM7341 performance is consistent over a wide voltage range, making the part useful for applications where the supply voltage can change, such as automotive electrical systems and battery powered electronics.

The LM7341 uses a small SOT23-5 package, which takes up little board space, and can be placed near signal sources to reduce noise pickup.



Please be aware that an important notice concerning availability, standard warranty, and use in critical applications of Texas Instruments semiconductor products and disclaimers thereto appears at the end of this data sheet.

All trademarks are the property of their respective owners.

Typical Performance Characteristics

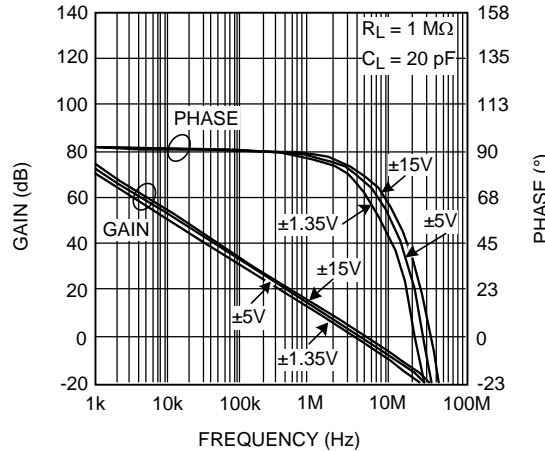

Figure 1. Open Loop Frequency Response

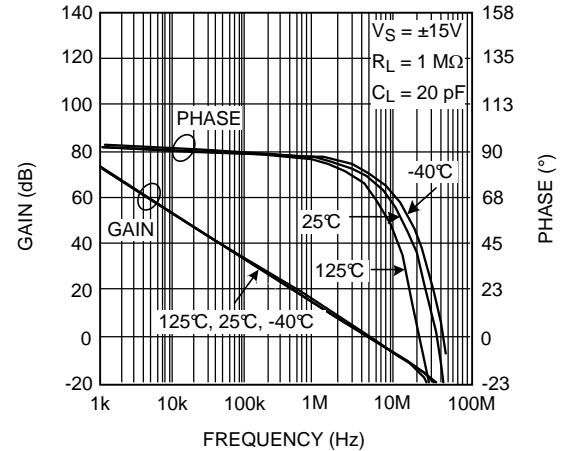

Figure 2. Open Loop Frequency Response



These devices have limited built-in ESD protection. The leads should be shorted together or the device placed in conductive foam during storage or handling to prevent electrostatic damage to the MOS gates.

Absolute Maximum Ratings⁽¹⁾⁽²⁾

ESD Tolerance ⁽³⁾	Human Body Model	2000V
	Machine Model	200V
	Charge-Device Model	1000V
V_{IN} Differential		±15V
Voltage at Input/Output Pin		(V ⁺) + 0.3V, (V ⁻) -0.3V
Supply Voltage ($V_S = V^+ - V^-$)		35V
Input Current		±10 mA
Output Current ⁽⁴⁾		±20 mA
Power Supply Current		25 mA
Soldering Information	Infrared or Convection (20 sec)	235°C
	Wave Soldering Lead Temp. (10 sec.)	260°C
Storage Temperature Range		-65°C to 150°C
Junction Temperature ⁽⁵⁾		150°C

- (1) Absolute Maximum Ratings indicate limits beyond which damage to the device may occur. Operating Ratings indicate conditions for which the device is intended to be functional, but specific performance is not ensured. For ensured specifications and the test conditions, see the Electrical Characteristics.
- (2) If Military/Aerospace specified devices are required, please contact the TI Sales Office/Distributors for availability and specifications.
- (3) Human Body Model, applicable std. MIL-STD-883, Method 3015.7. Machine Model, applicable std. JESD22-A115-A (ESD MM std. of JEDEC) Field-Induced Charge-Device Model, applicable std. JESD22-C101-C (ESD FICDM std. of JEDEC).
- (4) Applies to both single-supply and split-supply operation. Continuous short circuit operation at elevated ambient temperature can result in exceeding the maximum allowed junction temperature of 150°C.
- (5) The maximum power dissipation is a function of $T_{J(MAX)}$, θ_{JA} . The maximum allowable power dissipation at any ambient temperature is $P_D = (T_{J(MAX)} - T_A)/\theta_{JA}$. All numbers apply for packages soldered directly unto a PC board.

Operating Ratings⁽¹⁾

Supply Voltage ($V_S = V^+ - V^-$)		2.5V to 32V
Temperature Range ⁽²⁾		-40°C to 125°C
Package Thermal Resistance (θ_{JA})	5-Pin SOT-23	325°C/W

- (1) Absolute Maximum Ratings indicate limits beyond which damage to the device may occur. Operating Ratings indicate conditions for which the device is intended to be functional, but specific performance is not ensured. For ensured specifications and the test conditions, see the Electrical Characteristics.
- (2) The maximum power dissipation is a function of $T_{J(MAX)}$, θ_{JA} . The maximum allowable power dissipation at any ambient temperature is $P_D = (T_{J(MAX)} - T_A)/\theta_{JA}$. All numbers apply for packages soldered directly unto a PC board.

2.7V Electrical Characteristics

Unless otherwise specified, all limits ensured for $T_A = 25^\circ\text{C}$, $V^+ = 2.7\text{V}$, $V^- = 0\text{V}$, $V_{\text{CM}} = 0.5\text{V}$, $V_{\text{OUT}} = 1.35\text{V}$ and $R_L > 1\text{M}\Omega$ to 1.35V . **Boldface** limits apply at the temperature extremes

Symbol	Parameter	Conditions	Min ⁽¹⁾	Typ ⁽²⁾	Max ⁽¹⁾	Units
V_{OS}	Input Offset Voltage	$V_{\text{CM}} = 0.5\text{V}$ and $V_{\text{CM}} = 2.2\text{V}$	-4 -5	± 0.2	+4 +5	mV
TCV_{OS}	Input Offset Voltage Temperature Drift			± 2		$\mu\text{V}/^\circ\text{C}$
I_{B}	Input Bias Current	$V_{\text{CM}} = 0.5\text{V}$	-180 -200	-90		nA
		$V_{\text{CM}} = 2.2\text{V}$		30	60 70	
I_{OS}	Input Offset Current	$V_{\text{CM}} = 0.5\text{V}$ and $V_{\text{CM}} = 2.2\text{V}$		1	40 50	nA
CMRR	Common Mode Rejection Ratio	$0\text{V} \leq V_{\text{CM}} \leq 1.0\text{V}$	82 80	106		dB
		$0\text{V} \leq V_{\text{CM}} \leq 2.7\text{V}$	62 60	80		
PSRR	Power Supply Rejection Ratio	$2.7\text{V} \leq V_{\text{S}} \leq 30\text{V}$ $V_{\text{CM}} = 0.5\text{V}$	86 84	106		dB
CMVR	Common Mode Voltage Range	CMRR > 60 dB		-0.3	0.0	V
				2.7	3.0	
A_{VOL}	Open Loop Voltage Gain	$0.5\text{V} \leq V_{\text{O}} \leq 2.2\text{V}$ $R_L = 10\text{ k}\Omega$ to 1.35V	12 8	65		V/mV
V_{OUT}	Output Voltage Swing High	$R_L = 10\text{ k}\Omega$ to 1.35V $V_{\text{ID}} = 100\text{ mV}$		50	120 150	mV from either rail
		$R_L = 2\text{ k}\Omega$ to 1.35V $V_{\text{ID}} = 100\text{ mV}$		95	150 200	
	Output Voltage Swing Low	$R_L = 10\text{ k}\Omega$ to 1.35V $V_{\text{ID}} = -100\text{ mV}$		55	120 150	
		$R_L = 2\text{ k}\Omega$ to 1.35V $V_{\text{ID}} = -100\text{ mV}$		100	150 200	
I_{OUT}	Output Current	Sourcing, $V_{\text{OUT}} = 0\text{V}$ $V_{\text{ID}} = 200\text{ mV}$	6 4	12		mA
		Sinking, $V_{\text{OUT}} = 0\text{V}$ $V_{\text{ID}} = -200\text{ mV}$	5 3	10		
I_{S}	Supply Current	$V_{\text{CM}} = 0.5\text{V}$ and $V_{\text{CM}} = 2.2\text{V}$		0.6	0.9 1.0	mA
SR	Slew Rate	$\pm 1\text{V}$ Step		1.5		V/ μs
GBW	Gain Bandwidth	$f = 100\text{ kHz}$, $R_L = 100\text{ k}\Omega$		3.6		MHz
e_n	Input Referred Voltage Noise Density	$f = 1\text{ kHz}$		35		$\text{nV}/\sqrt{\text{Hz}}$
i_n	Input Referred Voltage Noise Density	$f = 1\text{ kHz}$		0.28		$\text{pA}/\sqrt{\text{Hz}}$
THD+N	Total Harmonic Distortion + Noise	$f = 10\text{ kHz}$		-66		dB
t_{PD}	Propagation Delay	Overdrive = $50\text{ mV}^{(3)}$		4		μs
		Overdrive = $1\text{V}^{(3)}$		3		
t_r	Rise Time	20% to 80% ⁽³⁾		1		μs
t_f	Fall Time	80% to 20% ⁽³⁾		1		μs

- (1) All limits are specified by testing or statistical analysis.
- (2) Typical values represent the most likely parametric norm as determined at the time of characterization. Actual typical values may vary over time and will also depend on the application and configuration. The typical values are not tested and are not ensured on shipped production material.
- (3) The maximum differential voltage between the input pins is $V_{\text{IN Differential}} = \pm 15\text{V}$.

±5V Electrical Characteristics

Unless otherwise specified, all limits ensured for $T_A = 25^\circ\text{C}$, $V^+ = +5\text{V}$, $V^- = -5\text{V}$, $V_{\text{CM}} = V_{\text{OUT}} = 0\text{V}$ and $R_L > 1\text{ M}\Omega$ to 0V .

Boldface limits apply at the temperature extremes.

Symbol	Parameter	Conditions	Min ⁽¹⁾	Typ ⁽²⁾	Max ⁽¹⁾	Units
V_{OS}	Input Offset Voltage	$V_{\text{CM}} = -4.5\text{V}$ and $V_{\text{CM}} = 4.5\text{V}$	-4 -5	±0.2	+4 +5	mV
TCV_{OS}	Input Offset Voltage Temperature Drift			±2		µV/°C
I_{B}	Input Bias Current	$V_{\text{CM}} = -4.5\text{V}$	-200 -250	-95		nA
		$V_{\text{CM}} = 4.5\text{V}$		35	70 80	
I_{OS}	Input Offset Current	$V_{\text{CM}} = -4.5\text{V}$ and $V_{\text{CM}} = 4.5\text{V}$		1	40 50	nA
CMRR	Common Mode Rejection Ratio	$-5\text{V} \leq V_{\text{CM}} \leq 3\text{V}$	84 82	112		dB
		$-5\text{V} \leq V_{\text{CM}} \leq 5\text{V}$	72 70	92		
PSRR	Power Supply Rejection Ratio	$2.7\text{V} \leq V_{\text{S}} \leq 30\text{V}$, $V_{\text{CM}} = -4.5\text{V}$	86 84	106		dB
CMVR	Common Mode Voltage Range	CMRR ≥ 65 dB		-5.3	-5.0	V
			5.0	5.3		
A_{VOL}	Open Loop Voltage Gain	$-4\text{V} \leq V_{\text{O}} \leq 4\text{V}$ $R_L = 10\text{ k}\Omega$ to 0V	20 12	110		V/mV
V_{OUT}	Output Voltage Swing High	$R_L = 10\text{ k}\Omega$ to 0V , $V_{\text{ID}} = 100\text{ mV}$		80	150 200	mV from either rail
		$R_L = 2\text{ k}\Omega$ to 0V , $V_{\text{ID}} = 100\text{ mV}$		170	300 400	
	Output Voltage Swing Low	$R_L = 10\text{ k}\Omega$ to 0V $V_{\text{ID}} = -100\text{ mV}$		90	150 200	
		$R_L = 2\text{ k}\Omega$ to 0V $V_{\text{ID}} = -100\text{ mV}$		210	300 400	
I_{OUT}	Output Current	Sourcing, $V_{\text{OUT}} = -5\text{V}$ $V_{\text{ID}} = 200\text{ mV}$	6 4	11		mA
		Sinking, $V_{\text{OUT}} = 5\text{V}$ $V_{\text{ID}} = -200\text{ mV}$	6 4	12		
I_{S}	Supply Current	$V_{\text{CM}} = -4.5\text{V}$ and $V_{\text{CM}} = 4.5\text{V}$		0.65	1.0 1.1	mA
SR	Slew Rate	±4V Step		1.7		V/µs
GBW	Gain Bandwidth	$f = 100\text{ kHz}$, $R_L = 100\text{ k}\Omega$		4.0		MHz
e_n	Input Referred Voltage Noise Density	$f = 1\text{ kHz}$		33		nV/√Hz
i_n	Input Referred Voltage Noise Density	$f = 1\text{ kHz}$		0.26		pA/√Hz
THD+N	Total Harmonic Distortion + Noise	$f = 10\text{ kHz}$		-66		dB
t_{PD}	Propagation Delay	Overdrive = $50\text{ mV}^{(3)}$		8		µs
		Overdrive = $1\text{V}^{(3)}$		6		
t_r	Rise Time	20% to 80% ⁽³⁾		5		µs
t_f	Fall Time	80% to 20% ⁽³⁾		5		µs

(1) All limits are specified by testing or statistical analysis.

(2) Typical values represent the most likely parametric norm as determined at the time of characterization. Actual typical values may vary over time and will also depend on the application and configuration. The typical values are not tested and are not ensured on shipped production material.

(3) The maximum differential voltage between the input pins is $V_{\text{IN Differential}} = \pm 15\text{V}$.

±15V Electrical Characteristics

Unless otherwise specified, all limits ensured for $T_A = 25^\circ\text{C}$, $V^+ = 15\text{V}$, $V^- = -15\text{V}$, $V_{\text{CM}} = V_{\text{OUT}} = 0\text{V}$ and $R_L > 1\text{ M}\Omega$ to 0V .

Boldface limits apply at the temperature extremes

Symbol	Parameter	Conditions	Min ⁽¹⁾	Typ ⁽²⁾	Max ⁽¹⁾	Units
V_{OS}	Input Offset Voltage	$V_{\text{CM}} = -14.5\text{V}$ and $V_{\text{CM}} = 14.5\text{V}$	-4 -5	± 0.2	+4 +5	mV
TCV_{OS}	Input Offset Voltage Temperature Drift			± 2		$\mu\text{V}/^\circ\text{C}$
I_{B}	Input Bias Current	$V_{\text{CM}} = -14.5\text{V}$	-250 -300	-110		nA
		$V_{\text{CM}} = 14.5\text{V}$		40	80 90	
I_{OS}	Input Offset Current	$V_{\text{CM}} = -14.5\text{V}$ and $V_{\text{CM}} = 14.5\text{V}$		1	40 50	nA
CMRR	Common Mode Rejection Ratio	$-15\text{V} \leq V_{\text{CM}} \leq 12\text{V}$	84 82	115		dB
		$-15\text{V} \leq V_{\text{CM}} \leq 15\text{V}$	78 76	100		
PSRR	Power Supply Rejection Ratio	$2.7\text{V} \leq V_{\text{S}} \leq 30\text{V}$, $V_{\text{CM}} = -14.5\text{V}$	86 84	106		dB
CMVR	Common Mode Voltage Range	CMRR > 80 dB		-15.3	-15.0	V
				15.0	15.3	
A_{VOL}	Open Loop Voltage Gain	$-13\text{V} \leq V_{\text{O}} \leq 13\text{V}$ $R_L = 10\text{ k}\Omega$ to 0V	25 15	200		V/mV
V_{OUT}	Output Voltage Swing High	$R_L = 10\text{ k}\Omega$ to 0V $V_{\text{ID}} = 100\text{ mV}$		135	300 400	mV from either rail
	Output Voltage Swing Low	$R_L = 10\text{ k}\Omega$ to 0V $V_{\text{ID}} = -100\text{ mV}$		160	300 400	
I_{OUT}	Output Current ⁽³⁾	Sourcing, $V_{\text{OUT}} = -15\text{V}$ $V_{\text{ID}} = 200\text{ mV}$	5 3	10		mA
		Sinking, $V_{\text{OUT}} = 15\text{V}$ $V_{\text{ID}} = -200\text{ mV}$	8 5	13		
I_{S}	Supply Current	$V_{\text{CM}} = -14.5\text{V}$ and $V_{\text{CM}} = 14.5\text{V}$		0.7	1.2 1.3	mA
SR	Slew Rate	$\pm 12\text{V}$ Step		1.9		V/ μs
GBW	Gain Bandwidth	$f = 100\text{ kHz}$, $R_L = 100\text{ k}\Omega$		4.6		MHz
e_{n}	Input Referred Voltage Noise Density	$f = 1\text{ kHz}$		31		$\text{nV}/\sqrt{\text{Hz}}$
i_{n}	Input Referred Current Noise Density	$f = 1\text{ kHz}$		0.27		$\text{pA}/\sqrt{\text{Hz}}$
THD+N	Total Harmonic Distortion + Noise	$f = 10\text{ kHz}$		-65		dB
t_{PD}	Propagation Delay	Overdrive = $50\text{ mV}^{(4)}$		17		μs
		Overdrive = $1\text{V}^{(4)}$		12		
t_{r}	Rise Time	20% to 80% ⁽⁴⁾		13		μs
t_{f}	Fall Time	80% to 20% ⁽⁴⁾		13		μs

(1) All limits are specified by testing or statistical analysis.

(2) Typical values represent the most likely parametric norm as determined at the time of characterization. Actual typical values may vary over time and will also depend on the application and configuration. The typical values are not tested and are not ensured on shipped production material.

(3) The maximum power dissipation is a function of $T_{\text{J(MAX)}}$, θ_{JA} . The maximum allowable power dissipation at any ambient temperature is $P_{\text{D}} = (T_{\text{J(MAX)}} - T_{\text{A}})/\theta_{\text{JA}}$. All numbers apply for packages soldered directly unto a PC board.

(4) The maximum differential voltage between the input pins is $V_{\text{IN Differential}} = \pm 15\text{V}$.

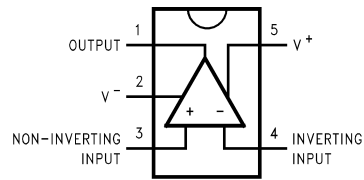
Connection Diagram**5-Pin SOT-23****Figure 3. Top View**

Typical Performance Characteristics

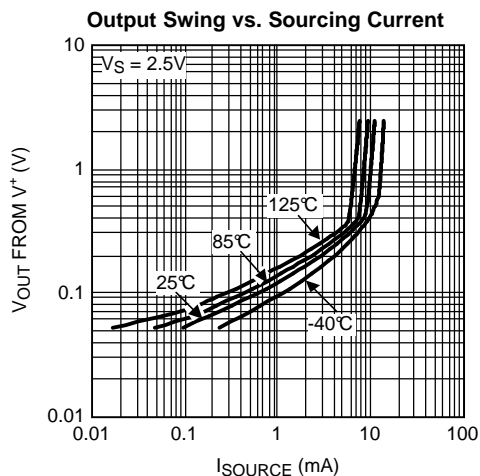

Figure 4.

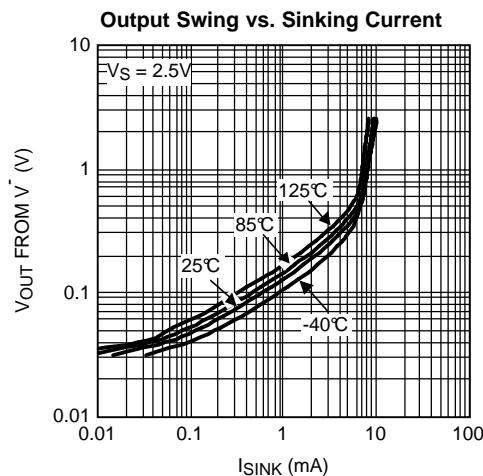

Figure 5.

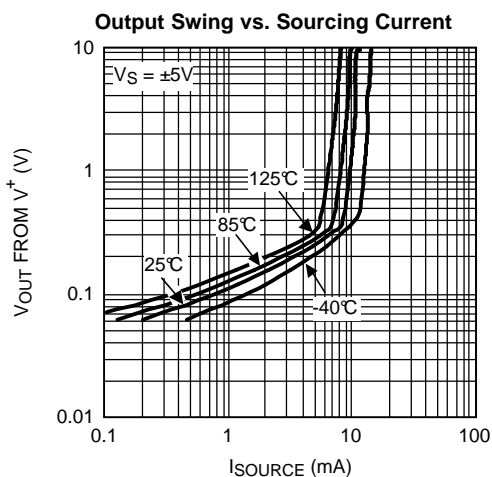

Figure 6.

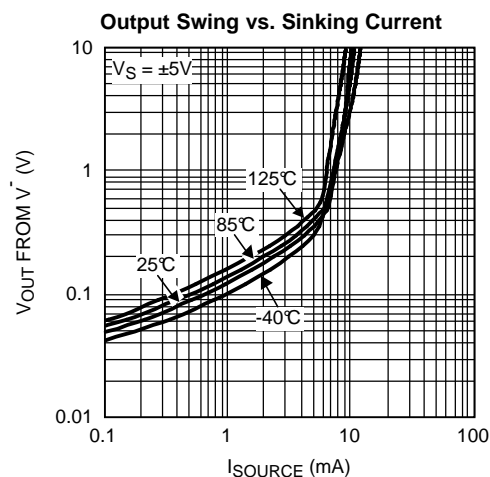

Figure 7.

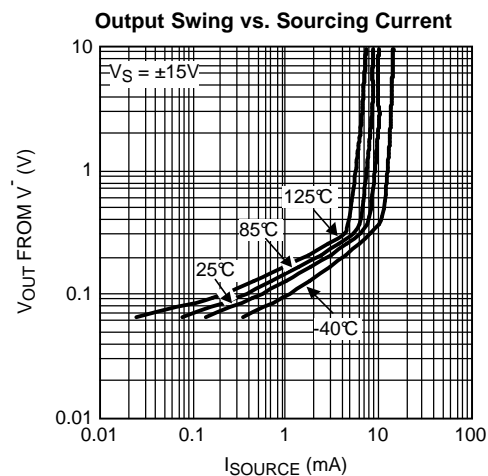

Figure 8.

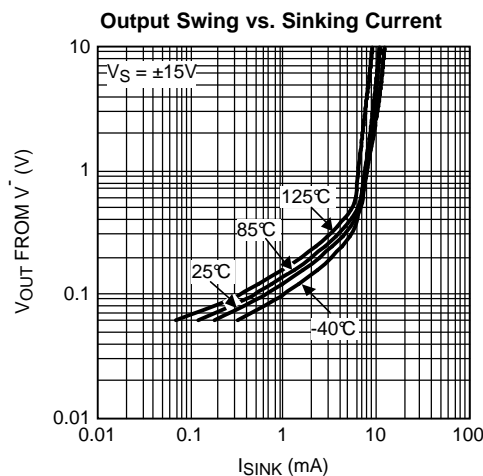

Figure 9.

Typical Performance Characteristics (continued)

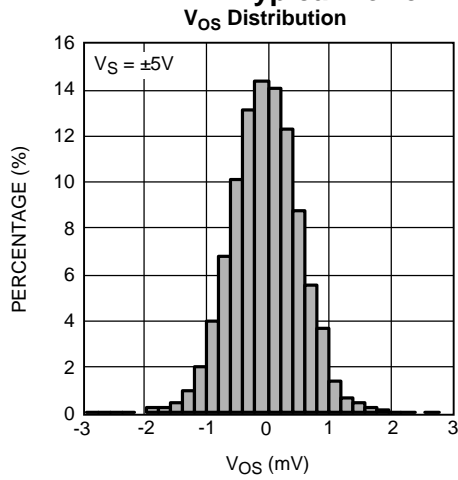

Figure 10.

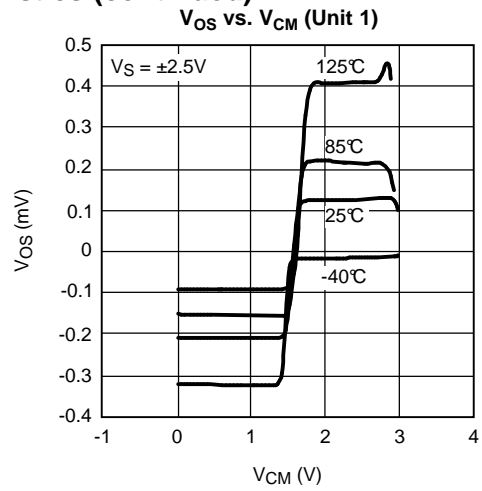

Figure 11.

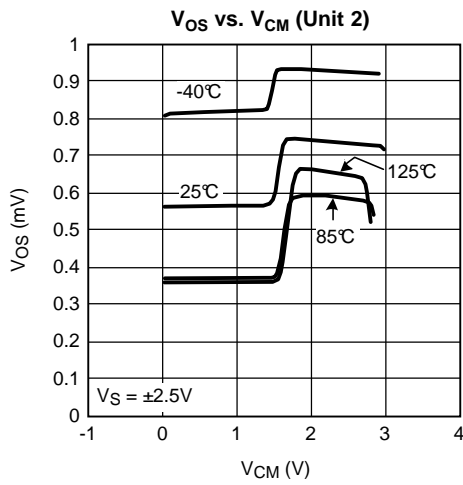

Figure 12.

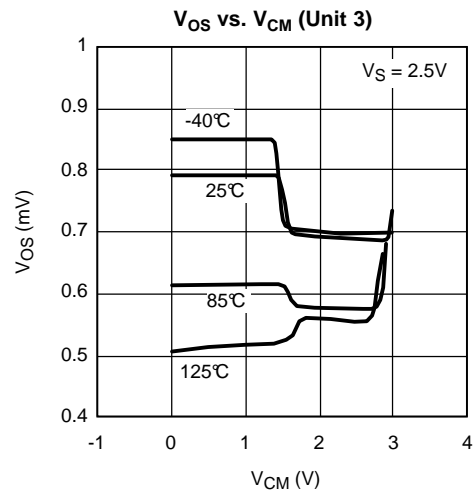

Figure 13.

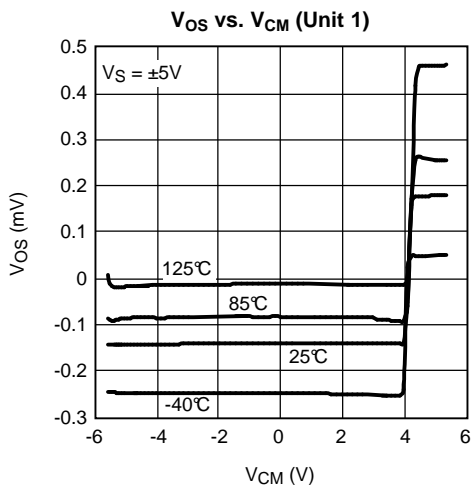

Figure 14.

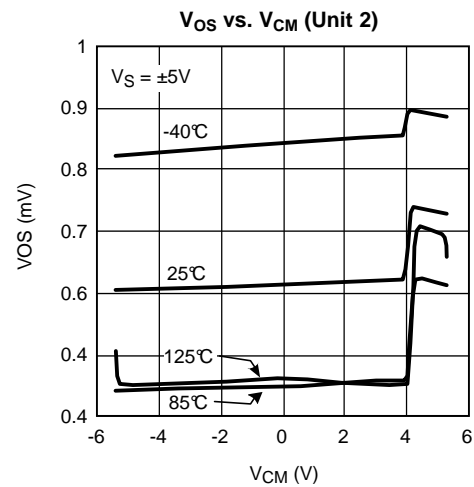

Figure 15.

Typical Performance Characteristics (continued)

V_{OS} vs. V_{CM} (Unit 3)

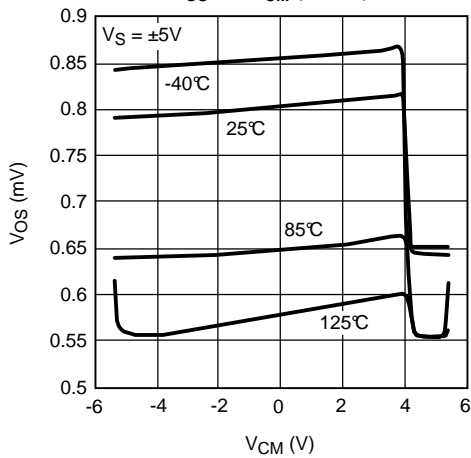

Figure 16.

V_{OS} vs. V_{CM} (Unit 1)

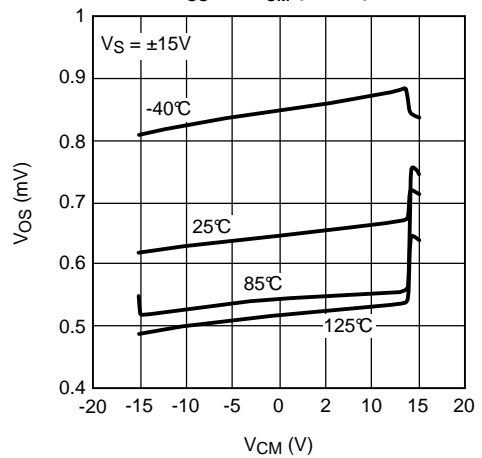

Figure 17.

V_{OS} vs. V_{CM} (Unit 2)

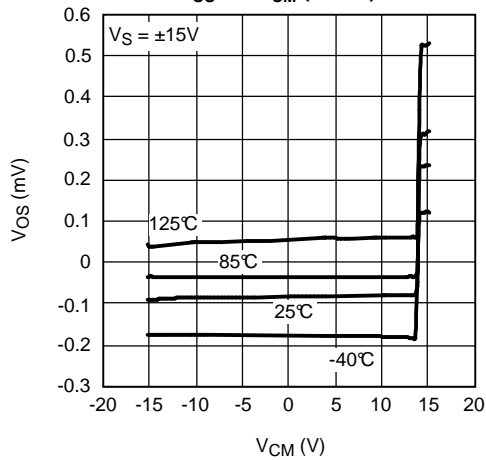

Figure 18.

V_{OS} vs. V_{CM} (Unit 3)

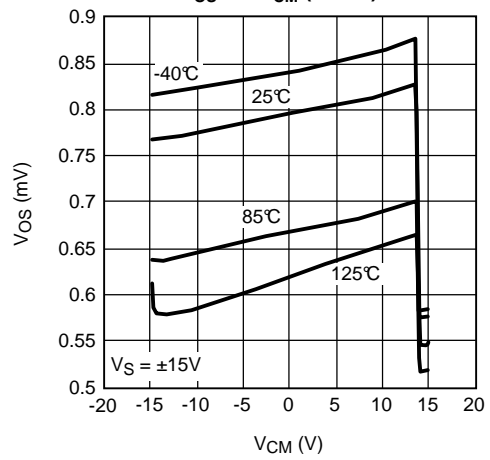

Figure 19.

V_{OS} vs. V_S (Unit 1)

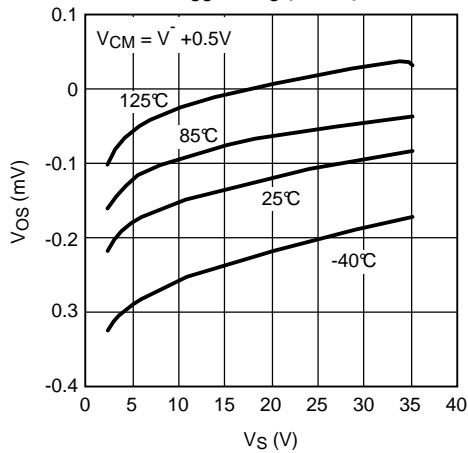

Figure 20.

V_{OS} vs. V_S (Unit 2)

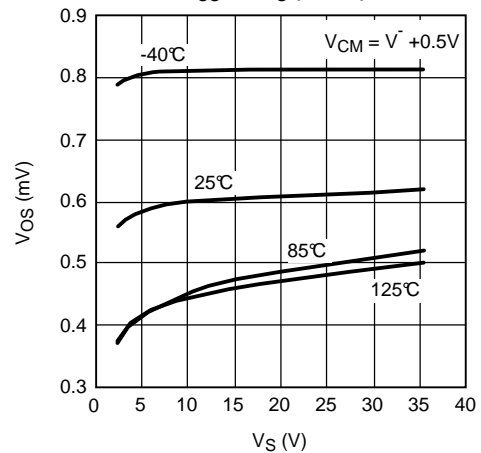

Figure 21.

Typical Performance Characteristics (continued)

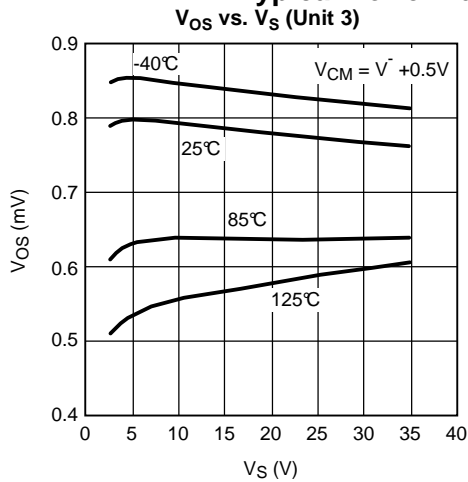

Figure 22.

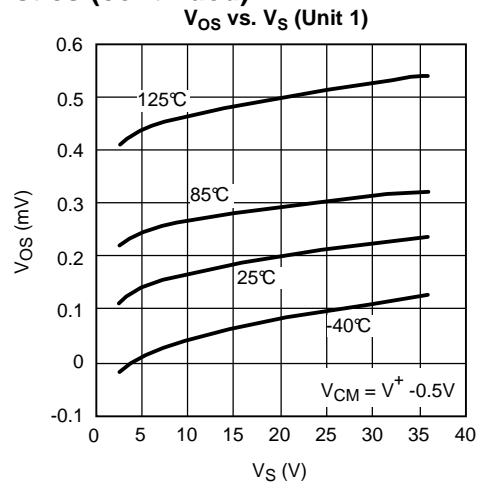

Figure 23.

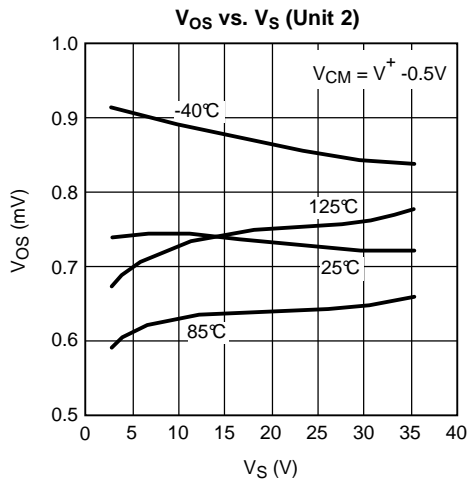

Figure 24.

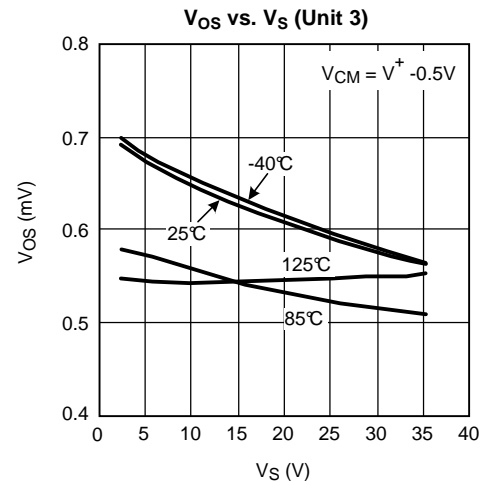

Figure 25.

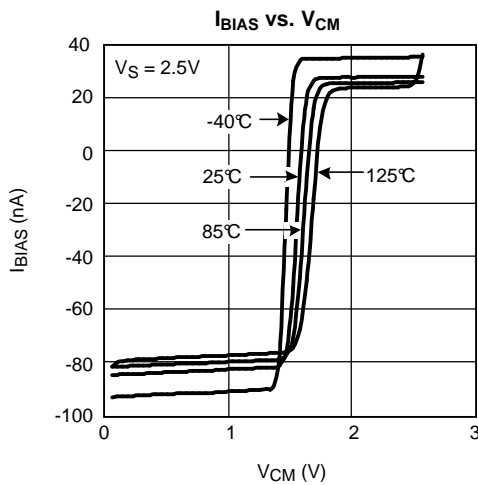

Figure 26.

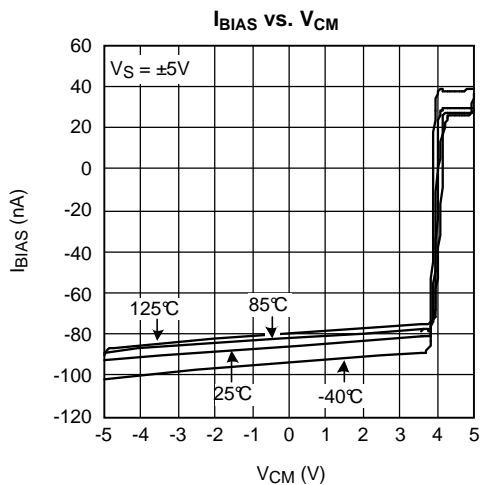

Figure 27.

Typical Performance Characteristics (continued)

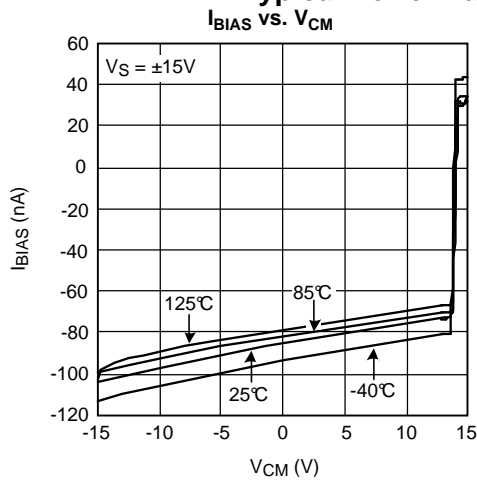

Figure 28.

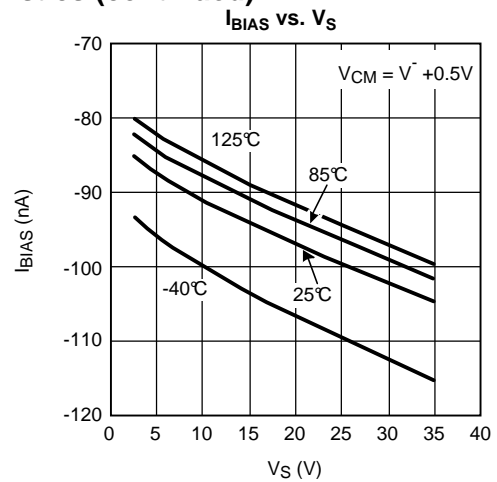

Figure 29.

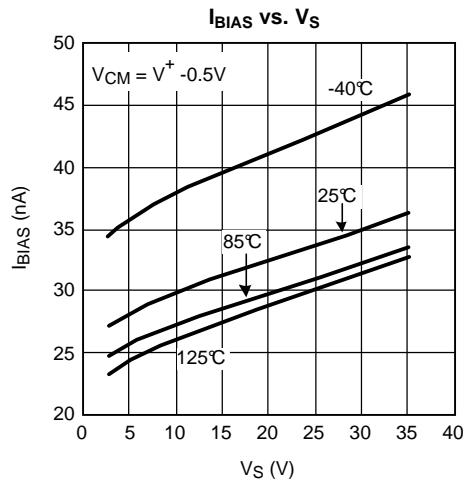

Figure 30.

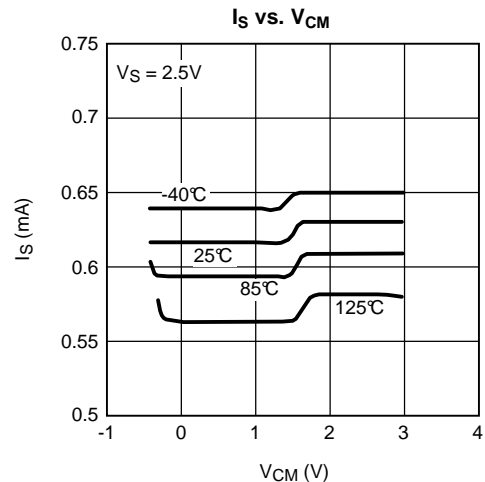

Figure 31.

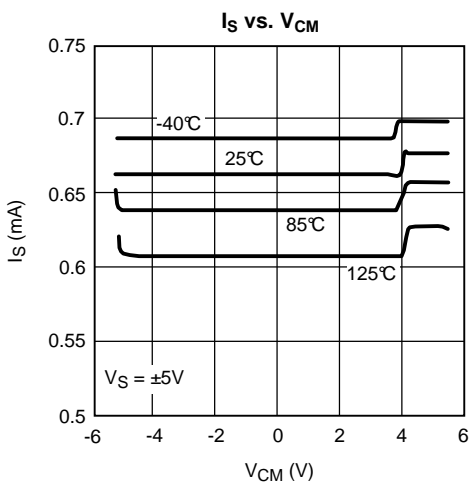

Figure 32.

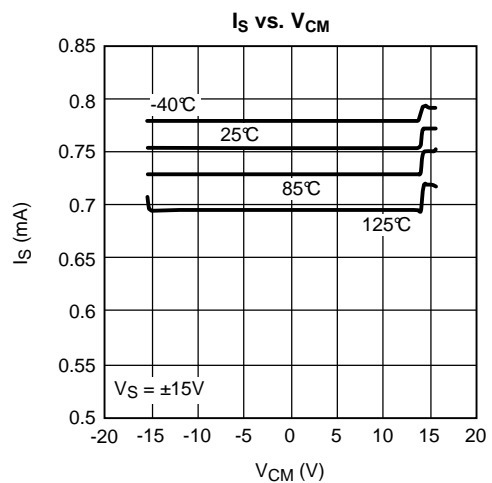

Figure 33.

Typical Performance Characteristics (continued)

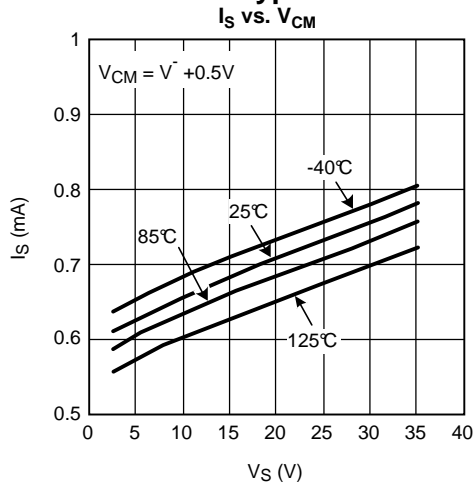

Figure 34.

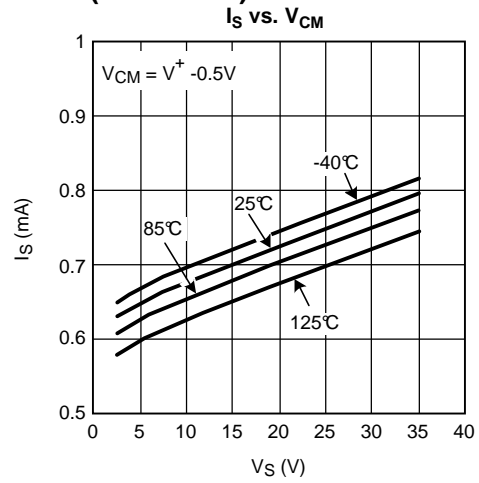

Figure 35.

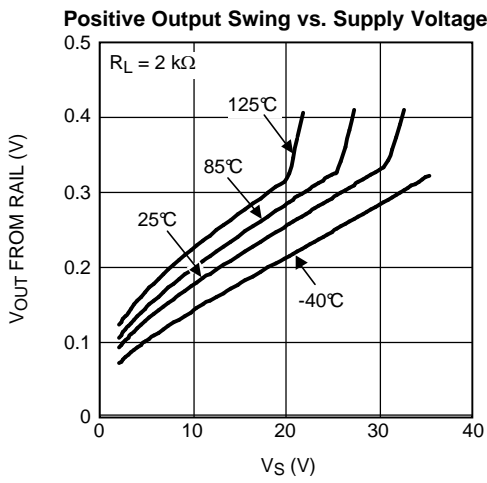

Figure 36.

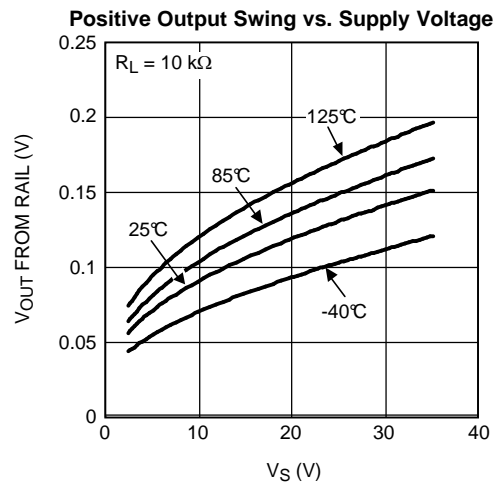

Figure 37.

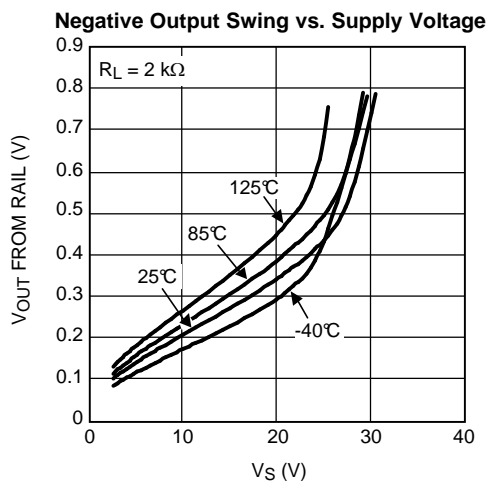

Figure 38.

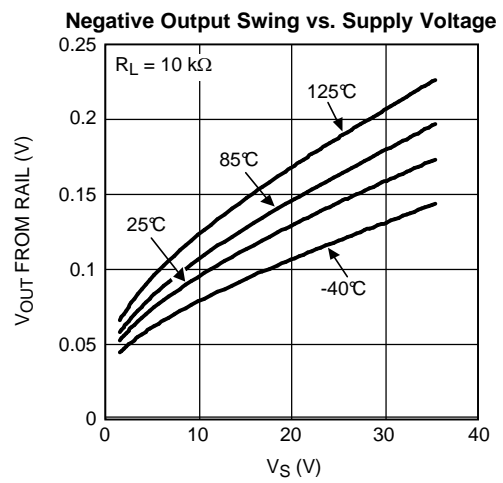

Figure 39.

Typical Performance Characteristics (continued)

Open Loop Frequency with Various Capacitive Load

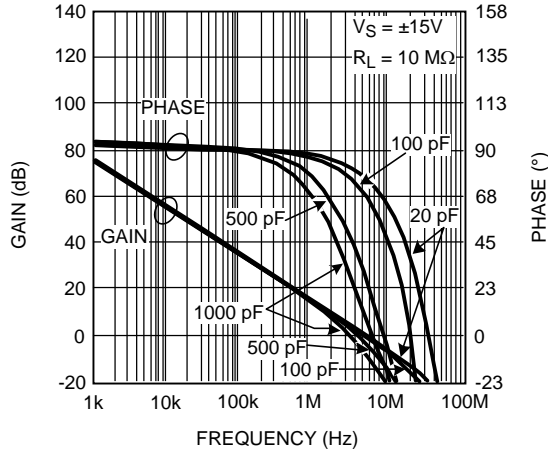

Figure 40.

Open Loop Frequency with Various Resistive Load

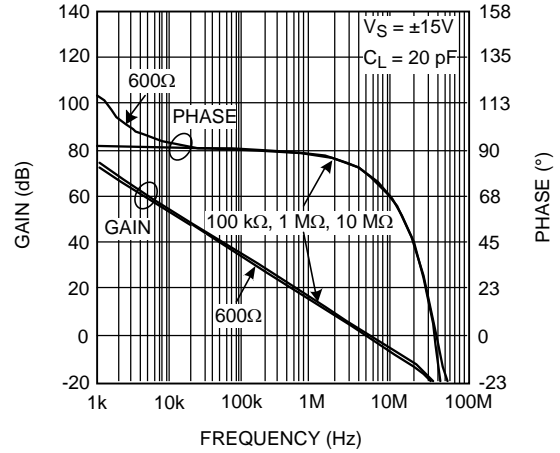

Figure 41.

Open Loop Frequency with Various Supply Voltage

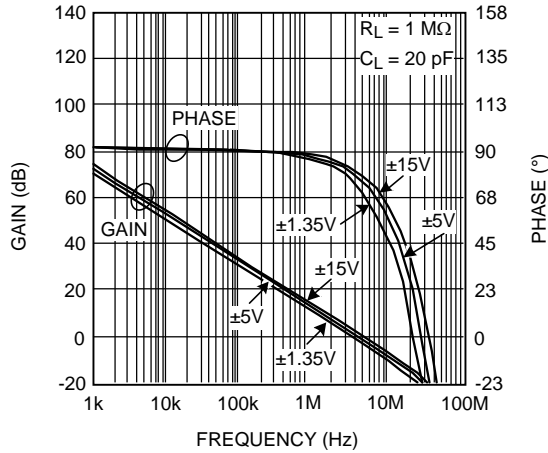

Figure 42.

Open Loop Frequency Response with Various Temperatures

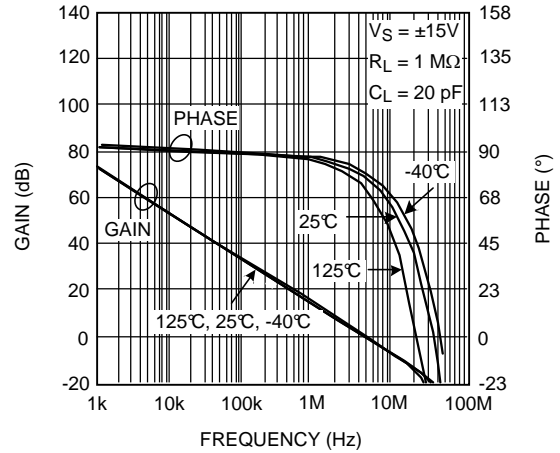

Figure 43.

CMRR vs. Frequency

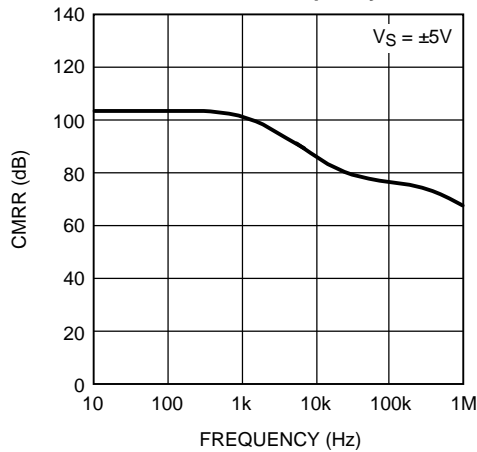

Figure 44.

+PSRR vs. Frequency

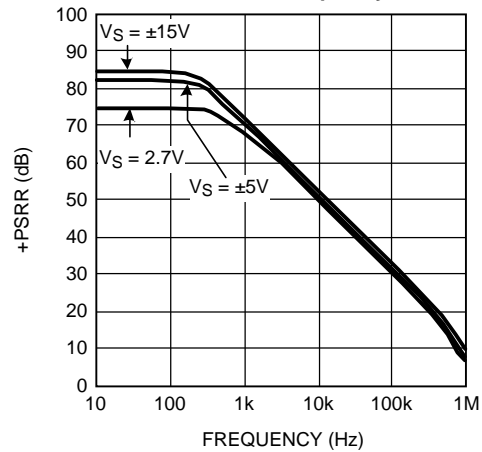

Figure 45.

Typical Performance Characteristics (continued)

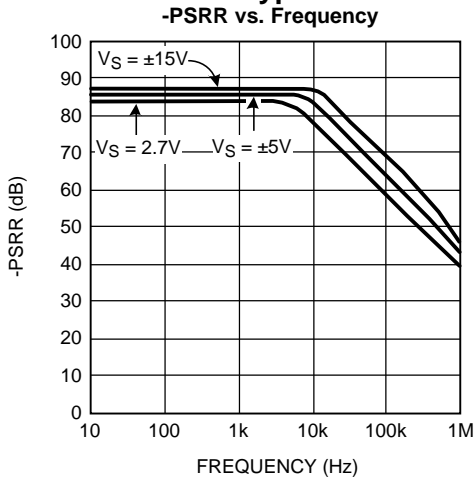

Figure 46.

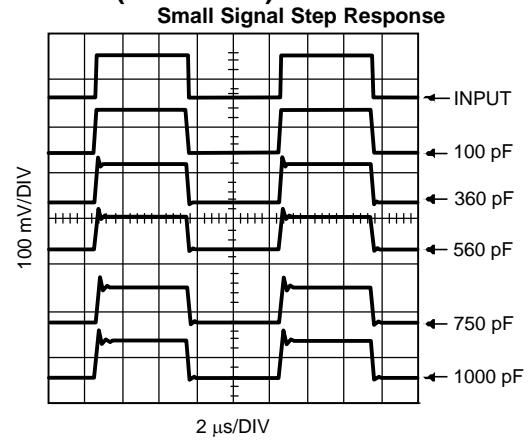

Figure 47.

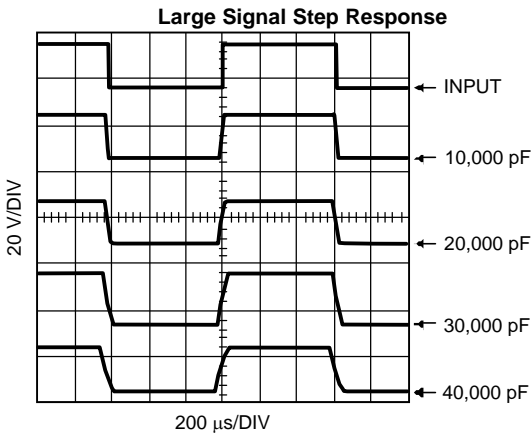

Figure 48.

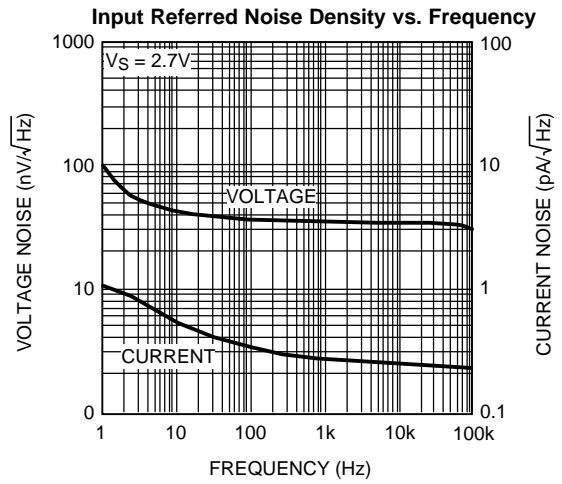

Figure 49.

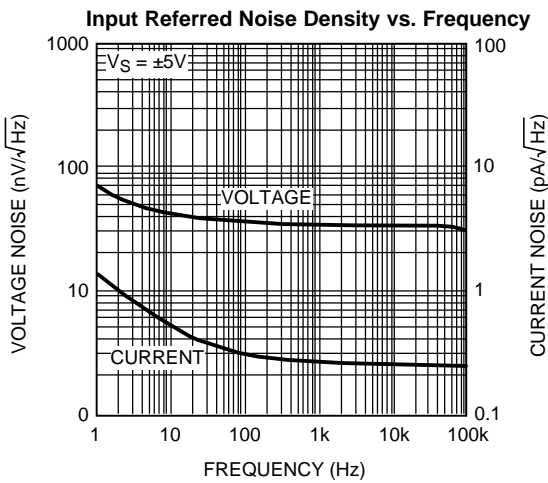

Figure 50.

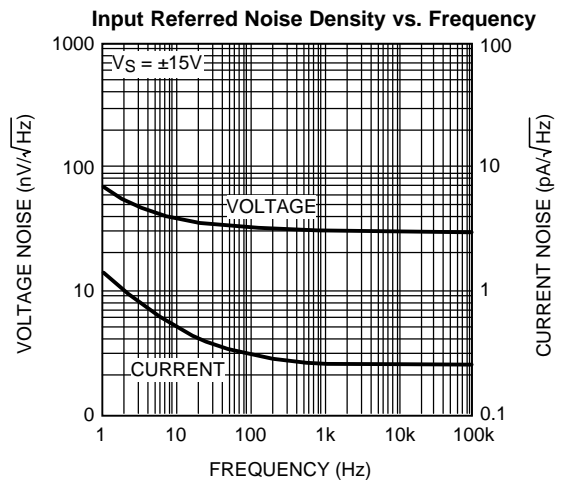

Figure 51.

Typical Performance Characteristics (continued)

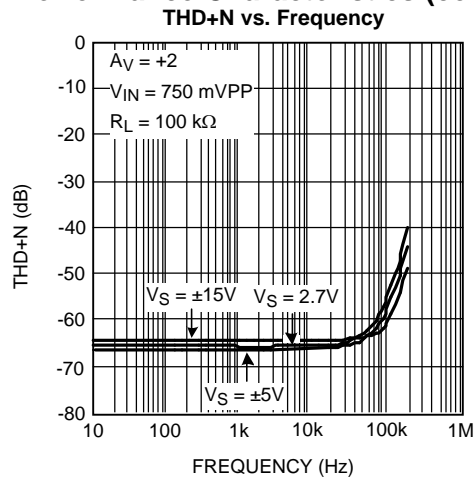

Figure 52.

APPLICATION INFORMATION

GENERAL INFORMATION

Low supply current and wide bandwidth, greater than rail-to-rail input range, full rail-to-rail output, good capacitive load driving ability, wide supply voltage and low distortion all make the LM7341 ideal for many diverse applications.

The high common-mode rejection ratio and full rail-to-rail input range provides precision performance when operated in non-inverting applications where the common-mode error is added directly to the other system errors.

CAPACITIVE LOAD DRIVING

The LM7341 has the ability to drive large capacitive loads. For example, 1000 pF only reduces the phase margin to about 30 degrees.

POWER DISSIPATION

Although the LM7341 has internal output current limiting, shorting the output to ground when operating on a +30V power supply will cause the op amp to dissipate about 350 mW. This is a worst-case example. In the 5-pin SOT-23 package, the higher thermal resistance will cause a calculated rise of 113°C. This can raise the junction temperature to above the absolute maximum temperature of 150°C.

Operating from split supplies greatly reduces the power dissipated when the output is shorted. Operating on $\pm 15V$ supplies can only cause a temperature rise of 57°C in the 5-pin SOT-23 package, assuming the short is to ground.

WIDE SUPPLY RANGE

The high power-supply rejection ratio (PSRR) and common mode rejection ratio (CMRR) provide precision performance when operated on battery or other unregulated supplies. This advantage is further enhanced by the very wide supply range (2.5V–32V) offered by the LM7341. In situations where highly variable or unregulated supplies are present, the excellent PSRR and wide supply range of the LM7341 benefit the system designer with continued precision performance, even in such adverse supply conditions.

SPECIFIC ADVANTAGES OF 5-Pin SOT-23 (TinyPak)

The obvious advantage of the 5-pin SOT-23, TinyPak, is that it can save board space, a critical aspect of any portable or miniaturized system design. The need to decrease overall system size is inherent in any handheld, portable, or lightweight system application.

Furthermore, the low profile can help in height limited designs, such as consumer hand-held remote controls, sub-notebook computers, and PCMCIA cards.

An additional advantage of the tiny package is that it allows better system performance due to ease of package placement. Because the tiny package is so small, it can fit on the board right where the op amp needs to be placed for optimal performance, unconstrained by the usual space limitations. This optimal placement of the tiny package allows for many system enhancements, not easily achieved with the constraints of a larger package. For example, problems such as system noise due to undesired pickup of digital signals can be easily reduced or mitigated. This pick-up problem is often caused by long wires in the board layout going to or from an op amp. By placing the tiny package closer to the signal source and allowing the LM7341 output to drive the long wire, the signal becomes less sensitive to such pick-up. An overall reduction of system noise results.

Often times system designers try to save space by using dual or quad op amps in their board layouts. This causes a complicated board layout due to the requirement of routing several signals to and from the same place on the board. Using the tiny op amp eliminates this problem.

Additional space savings parts are available in tiny packages from Texas Instruments, including low power amplifiers, precision voltage references, and voltage regulators.

LOW DISTORTION, HIGH OUTPUT DRIVE CAPABILITY

The LM7341 offers superior low-distortion performance, with a total-harmonic-distortion-plus-noise of -66 dB at $f = 10$ kHz. The advantage offered by the LM7341 is its low distortion levels, even at high output current and low load resistance.

Typical Applications

HANDHELD REMOTE CONTROLS

The LM7341 offers outstanding specifications for applications requiring good speed/power trade-off. In applications such as remote control operation, where high bandwidth and low power consumption are needed. The LM7341 performance can easily meet these requirements.

OPTICAL LINE ISOLATION FOR MODEMS

The combination of the low distortion and good load driving capabilities of the LM7341 make it an excellent choice for driving opto-coupler circuits to achieve line isolation for modems. This technique prevents telephone line noise from coupling onto the modem signal. Superior isolation is achieved by coupling the signal optically from the computer modem to the telephone lines; however, this also requires a low distortion at relatively high currents. Due to its low distortion at high output drive currents, the LM7341 fulfills this need, in this and in other telecom applications.

REMOTE MICROPHONE IN PERSONAL COMPUTERS

Remote microphones in Personal Computers often utilize a microphone at the top of the monitor which must drive a long cable in a high noise environment. One method often used to reduce the noise is to lower the signal impedance, which reduces the noise pickup. In this configuration, the amplifier usually requires 30 dB–40 dB of gain, at bandwidths higher than most low-power CMOS parts can achieve. The LM7341 offers the tiny package, higher bandwidths, and greater output drive capability than other rail-to-rail input/output parts can provide for this application.

LM7341 AS A COMPARATOR

The LM7341 can also be used as a comparator and provides quite reasonable performance. Note however that unlike a typical comparator an op amp has a maximum allowed differential voltage between the input pins. For the LM7341, as stated in the [Absolute Maximum Ratings](#) section, this maximum voltage is V_{IN} Differential = ± 15 V. Beyond this limit, even for a short time, damage to the device may occur.

As an inverting comparator at $V_S = 30$ V and 1V of overdrive there is typically 12 μ s of propagation delay. At $V_S = 30$ V and 50 mV of overdrive there is typically 17 μ s of propagation delay.

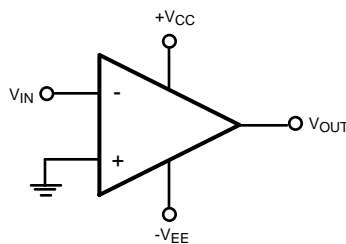

Figure 53. Inverting Comparator

Similarly a non-inverting comparator at $V_S = 30$ V and 1V of overdrive there is typically 12 μ s of propagation delay. At $V_S = 30$ V and 50 mV of overdrive there is typically 17 μ s of propagation delay.

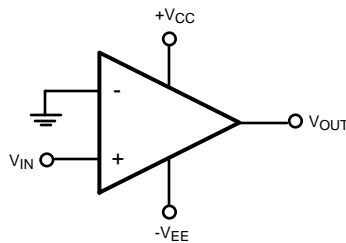

Figure 54. Non-Inverting Comparator

COMPARATOR WITH HYSTERESIS

The basic comparator configuration may oscillate or produce a noisy output if the applied differential input voltage is near the comparator's offset voltage. This usually happens when the input signal is moving very slowly across the comparator's switching threshold. This problem can be prevented by the addition of hysteresis or positive feedback.

INVERTING COMPARATOR WITH HYSTERESIS

The inverting comparator with hysteresis requires a three resistor network that is referenced to the supply voltage V_{CC} of the comparator, as shown in [Figure 55](#). When V_{IN} at the inverting input is less than V_A , the voltage at the non-inverting node of the comparator ($V_{IN} < V_A$), the output voltage is high (for simplicity assume V_{OUT} switches as high as V_{CC}). The three network resistors can be represented as $R_1 || R_3$ in series with R_2 . The lower input trip voltage V_{A1} is defined as

$$V_{A1} = V_{CC} R_2 / ((R_1 || R_3) + R_2) \quad (1)$$

When V_{IN} is greater than V_A ($V_{IN} > V_A$), the output voltage is low, very close to ground. In this case the three network resistors can be presented as $R_2 || R_3$ in series with R_1 . The upper trip voltage V_{A2} is defined as

$$V_{A2} = V_{CC} (R_2 || R_3) / ((R_1 + (R_2 || R_3))) \quad (2)$$

The total hysteresis provided by the network is defined as

$$\Delta V_A = V_{A1} - V_{A2} \quad (3)$$

For example to achieve 50 mV of hysteresis when $V_{CC} = 30V$ set $R_1 = 4.02 \text{ k}\Omega$, $R_2 = 4.02 \text{ k}\Omega$, and $R_3 = 1.21 \text{ M}\Omega$. With these resistors selected the error due to input bias current is approximately 1 mV. To minimize this error it is best to use low resistor values on the inputs.

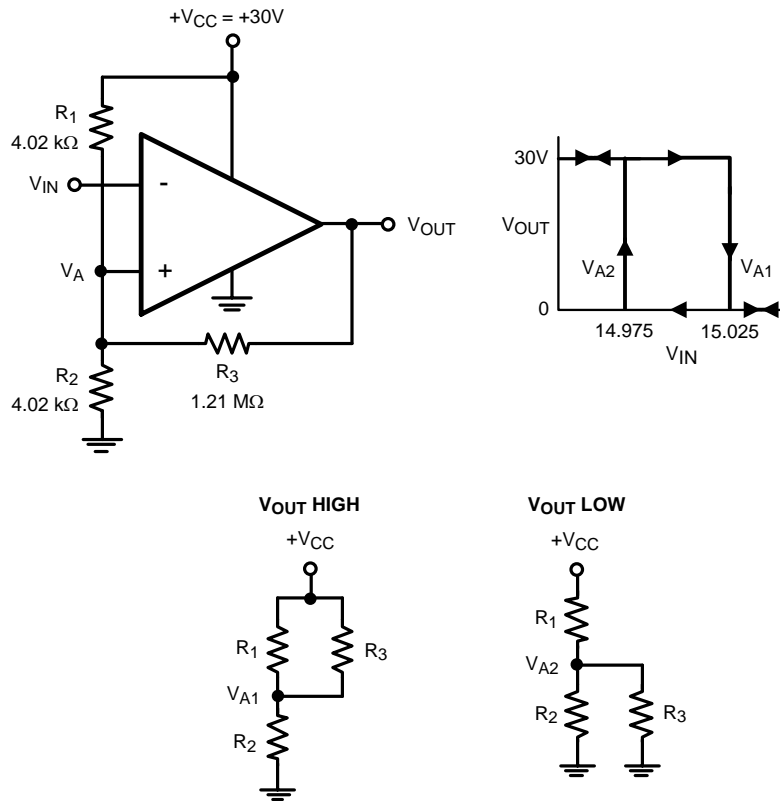

Figure 55. Inverting Comparator with Hysteresis

NON-INVERTING COMPARATOR WITH HYSTERESIS

A non-inverting comparator with hysteresis requires a two resistor network, and a voltage reference (V_{REF}) at the inverting input. When V_{IN} is low, the output is also low. For the output to switch from low to high, V_{IN} must rise up to V_{IN1} where V_{IN1} is calculated by

$$V_{IN1} = R_1 * (V_{REF} / R_2) + V_{REF} \quad (4)$$

When V_{IN} is high, the output is also high, to make the comparator switch back to it's low state, V_{IN} must equal V_{REF} before V_A will again equal V_{REF} . V_{IN} can be calculated by

$$V_{IN2} = (V_{REF} (R_1 + R_2) - V_{CC} R_1) / R_2 \quad (5)$$

The hysteresis of this circuit is the difference between V_{IN1} and V_{IN2} .

$$\Delta V_{IN} = V_{CC} R_1 / R_2 \quad (6)$$

For example to achieve 50 mV of hysteresis when $V_{CC} = 30V$ set $R_1 = 20\Omega$ and $R_2 = 12.1 k\Omega$.

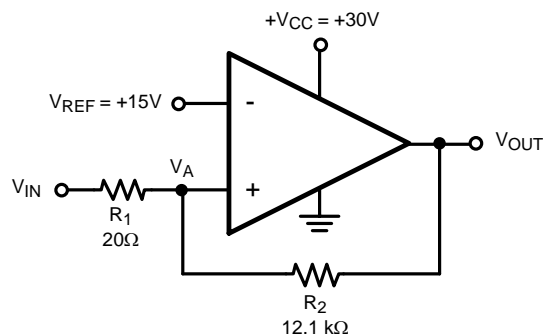

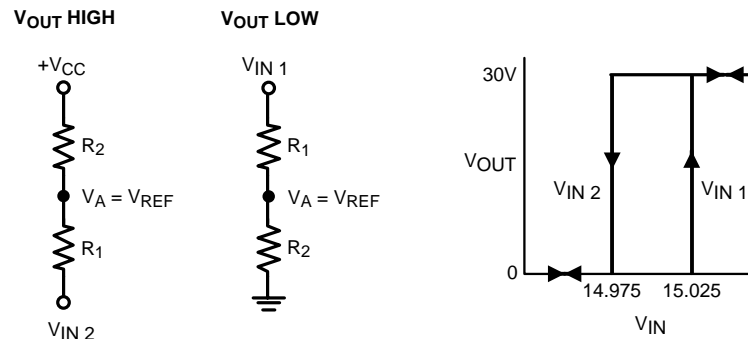

Figure 56. Non-Inverting Comparator with Hysteresis

OTHER SOT-23 AMPLIFIERS

The **LM7321** is a rail-to-rail input and output amplifier that can tolerate unlimited capacitive load. It works from 2.7V to ± 15 V and across the -40°C to 125°C temperature range. It has 20 MHz gain-bandwidth, and is available in both 5-Pin SOT-23 and 8-Pin SOIC packages.

The **LM6211** is a 20 MHz part with CMOS input, which runs on 5V to 24V single supplies. It has rail-to-rail output and low noise.

The **LMP7701** is a rail-to-rail input and output precision part with an input voltage offset under 220 microvolts and low noise. It has 2.5 MHz bandwidth and works on 2.7V to 12V supplies.

SMALLER SC70 AMPLIFIERS

The **LMV641** is a 10 MHz amplifier which uses only 140 micro amps of supply current. The input voltage offset is less than 0.5 mV.

The **LMV851** is an 8 MHz amplifier which uses only 0.4 mA supply current, and is available in the smaller SC70 package. The LMV851 also resists Electro Magnetic Interference (EMI) from mobile phones and similar high frequency sources. It works on 2.7V to 5.5 V supplies.

Detailed information on these and a wide range of other parts can be found at www.ti.com.

REVISION HISTORY

Changes from Revision A (March 2013) to Revision B	Page
<hr/> <ul style="list-style-type: none">• Changed layout of National Data Sheet to TI format	<hr/> 20

PACKAGING INFORMATION

Orderable Device	Status (1)	Package Type	Package Drawing	Pins	Package Qty	Eco Plan (2)	Lead finish/ Ball material (6)	MSL Peak Temp (3)	Op Temp (°C)	Device Marking (4/5)	Samples
LM7341MF/NOPB	LIFEBUY	SOT-23	DBV	5	1000	RoHS & Green	SN	Level-1-260C-UNLIM	-40 to 125	AV4A	
LM7341MFE/NOPB	LIFEBUY	SOT-23	DBV	5	250	RoHS & Green	SN	Level-1-260C-UNLIM	-40 to 125	AV4A	
LM7341MFX/NOPB	ACTIVE	SOT-23	DBV	5	3000	RoHS & Green	SN	Level-1-260C-UNLIM	-40 to 125	AV4A	Samples

(1) The marketing status values are defined as follows:

ACTIVE: Product device recommended for new designs.

LIFEBUY: TI has announced that the device will be discontinued, and a lifetime-buy period is in effect.

NRND: Not recommended for new designs. Device is in production to support existing customers, but TI does not recommend using this part in a new design.

PREVIEW: Device has been announced but is not in production. Samples may or may not be available.

OBSOLETE: TI has discontinued the production of the device.

(2) **RoHS:** TI defines "RoHS" to mean semiconductor products that are compliant with the current EU RoHS requirements for all 10 RoHS substances, including the requirement that RoHS substance do not exceed 0.1% by weight in homogeneous materials. Where designed to be soldered at high temperatures, "RoHS" products are suitable for use in specified lead-free processes. TI may reference these types of products as "Pb-Free".

RoHS Exempt: TI defines "RoHS Exempt" to mean products that contain lead but are compliant with EU RoHS pursuant to a specific EU RoHS exemption.

Green: TI defines "Green" to mean the content of Chlorine (Cl) and Bromine (Br) based flame retardants meet JS709B low halogen requirements of <=1000ppm threshold. Antimony trioxide based flame retardants must also meet the <=1000ppm threshold requirement.

(3) MSL, Peak Temp. - The Moisture Sensitivity Level rating according to the JEDEC industry standard classifications, and peak solder temperature.

(4) There may be additional marking, which relates to the logo, the lot trace code information, or the environmental category on the device.

(5) Multiple Device Markings will be inside parentheses. Only one Device Marking contained in parentheses and separated by a "~" will appear on a device. If a line is indented then it is a continuation of the previous line and the two combined represent the entire Device Marking for that device.

(6) Lead finish/Ball material - Orderable Devices may have multiple material finish options. Finish options are separated by a vertical ruled line. Lead finish/Ball material values may wrap to two lines if the finish value exceeds the maximum column width.

Important Information and Disclaimer:The information provided on this page represents TI's knowledge and belief as of the date that it is provided. TI bases its knowledge and belief on information provided by third parties, and makes no representation or warranty as to the accuracy of such information. Efforts are underway to better integrate information from third parties. TI has taken and continues to take reasonable steps to provide representative and accurate information but may not have conducted destructive testing or chemical analysis on incoming materials and chemicals. TI and TI suppliers consider certain information to be proprietary, and thus CAS numbers and other limited information may not be available for release.

In no event shall TI's liability arising out of such information exceed the total purchase price of the TI part(s) at issue in this document sold by TI to Customer on an annual basis.

TAPE AND REEL INFORMATION

QUADRANT ASSIGNMENTS FOR PIN 1 ORIENTATION IN TAPE

*All dimensions are nominal

Device	Package Type	Package Drawing	Pins	SPQ	Reel Diameter (mm)	Reel Width W1 (mm)	A0 (mm)	B0 (mm)	K0 (mm)	P1 (mm)	W (mm)	Pin1 Quadrant
LM7341MF/NOPB	SOT-23	DBV	5	1000	178.0	8.4	3.2	3.2	1.4	4.0	8.0	Q3
LM7341MFE/NOPB	SOT-23	DBV	5	250	178.0	8.4	3.2	3.2	1.4	4.0	8.0	Q3
LM7341MFX/NOPB	SOT-23	DBV	5	3000	178.0	8.4	3.2	3.2	1.4	4.0	8.0	Q3

TAPE AND REEL BOX DIMENSIONS

*All dimensions are nominal

Device	Package Type	Package Drawing	Pins	SPQ	Length (mm)	Width (mm)	Height (mm)
LM7341MF/NOPB	SOT-23	DBV	5	1000	208.0	191.0	35.0
LM7341MFE/NOPB	SOT-23	DBV	5	250	208.0	191.0	35.0
LM7341MFX/NOPB	SOT-23	DBV	5	3000	208.0	191.0	35.0

DBV0005A



PACKAGE OUTLINE

SOT-23 - 1.45 mm max height

SMALL OUTLINE TRANSISTOR

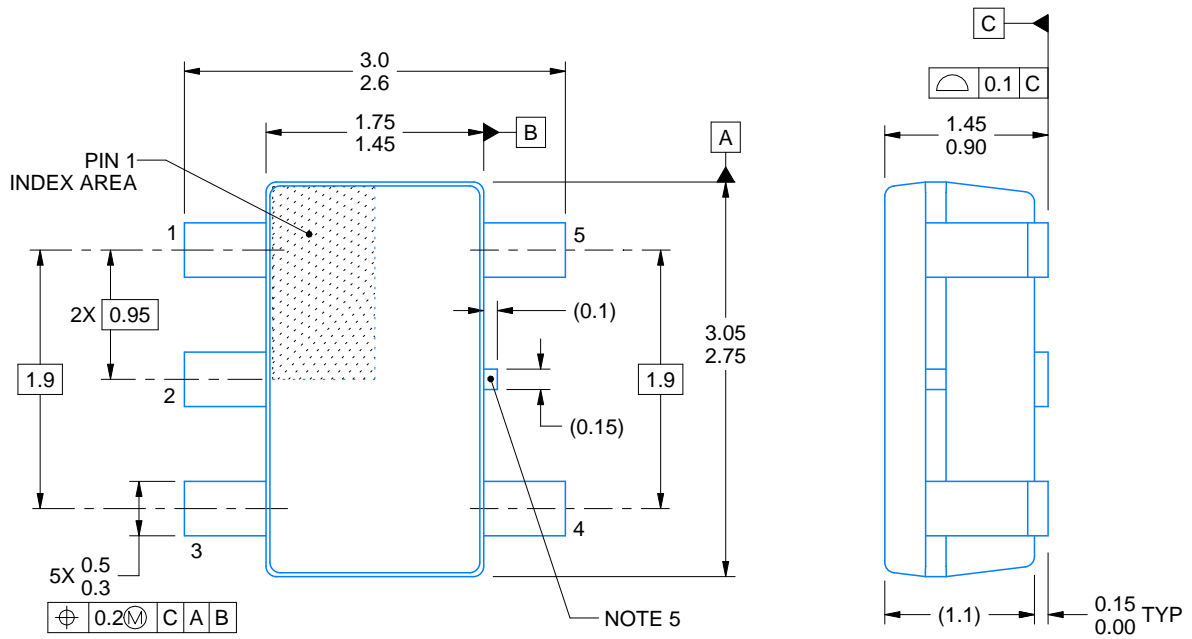

4214839/G 03/2023

NOTES:

1. All linear dimensions are in millimeters. Any dimensions in parenthesis are for reference only. Dimensioning and tolerancing per ASME Y14.5M.
2. This drawing is subject to change without notice.
3. Reference JEDEC MO-178.
4. Body dimensions do not include mold flash, protrusions, or gate burrs. Mold flash, protrusions, or gate burrs shall not exceed 0.25 mm per side.
5. Support pin may differ or may not be present.

EXAMPLE BOARD LAYOUT

DBV0005A

SOT-23 - 1.45 mm max height

SMALL OUTLINE TRANSISTOR



LAND PATTERN EXAMPLE
EXPOSED METAL SHOWN
SCALE:15X

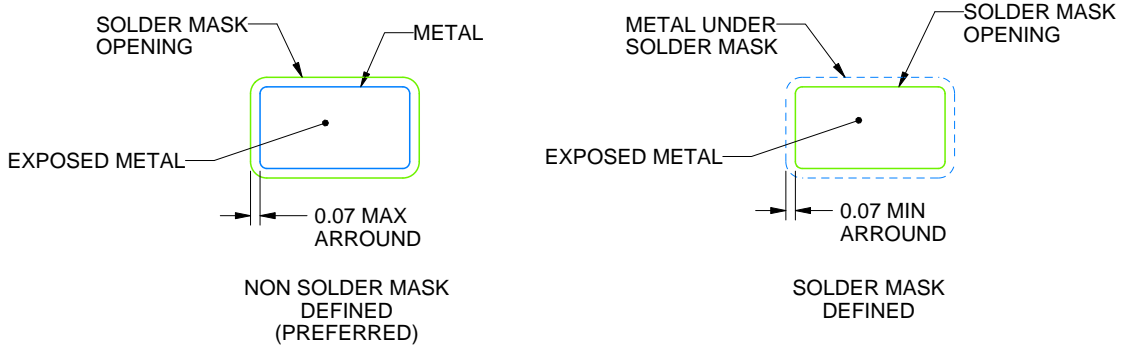

SOLDER MASK DETAILS

4214839/G 03/2023

NOTES: (continued)

- 6. Publication IPC-7351 may have alternate designs.
- 7. Solder mask tolerances between and around signal pads can vary based on board fabrication site.

EXAMPLE STENCIL DESIGN

DBV0005A

SOT-23 - 1.45 mm max height

SMALL OUTLINE TRANSISTOR



SOLDER PASTE EXAMPLE
BASED ON 0.125 mm THICK STENCIL
SCALE:15X

4214839/G 03/2023

NOTES: (continued)

8. Laser cutting apertures with trapezoidal walls and rounded corners may offer better paste release. IPC-7525 may have alternate design recommendations.
9. Board assembly site may have different recommendations for stencil design.

IMPORTANT NOTICE AND DISCLAIMER

TI PROVIDES TECHNICAL AND RELIABILITY DATA (INCLUDING DATA SHEETS), DESIGN RESOURCES (INCLUDING REFERENCE DESIGNS), APPLICATION OR OTHER DESIGN ADVICE, WEB TOOLS, SAFETY INFORMATION, AND OTHER RESOURCES "AS IS" AND WITH ALL FAULTS, AND DISCLAIMS ALL WARRANTIES, EXPRESS AND IMPLIED, INCLUDING WITHOUT LIMITATION ANY IMPLIED WARRANTIES OF MERCHANTABILITY, FITNESS FOR A PARTICULAR PURPOSE OR NON-INFRINGEMENT OF THIRD PARTY INTELLECTUAL PROPERTY RIGHTS.

These resources are intended for skilled developers designing with TI products. You are solely responsible for (1) selecting the appropriate TI products for your application, (2) designing, validating and testing your application, and (3) ensuring your application meets applicable standards, and any other safety, security, regulatory or other requirements.

These resources are subject to change without notice. TI grants you permission to use these resources only for development of an application that uses the TI products described in the resource. Other reproduction and display of these resources is prohibited. No license is granted to any other TI intellectual property right or to any third party intellectual property right. TI disclaims responsibility for, and you will fully indemnify TI and its representatives against, any claims, damages, costs, losses, and liabilities arising out of your use of these resources.

TI's products are provided subject to [TI's Terms of Sale](#) or other applicable terms available either on [ti.com](https://www.ti.com) or provided in conjunction with such TI products. TI's provision of these resources does not expand or otherwise alter TI's applicable warranties or warranty disclaimers for TI products.

TI objects to and rejects any additional or different terms you may have proposed.

Mailing Address: Texas Instruments, Post Office Box 655303, Dallas, Texas 75265
Copyright © 2023, Texas Instruments Incorporated