

LMV34x-N Single Rail-to-Rail Output CMOS Operation Amplifier With Shutdown

1 Features

- Typical 2.7 V Supply Values (Unless Otherwise Noted)
- Ensured 2.7 V and 5 V Specifications
- Input Referred Voltage Noise at 10 kHz: 29 nV/√Hz
- Supply Current (Per Amplifier): 100 μA
- Gain Bandwidth Product: 1 MHz
- Slew Rate: 1 V/μs
- Shutdown Current (LMV341-N): 45 pA
- Turnon Time From Shutdown (LMV341-N): 5 μs
- Input Bias Current: 20 fA

2 Applications

- Cordless or Cellular Phones
- Laptops
- PDAs
- PCMCIA or Audio
- Portable or Battery-Powered Electronic Equipment
- Supply Current Monitoring
- Battery Monitoring
- Buffers
- Filters
- Drivers

Sample and Hold Circuit

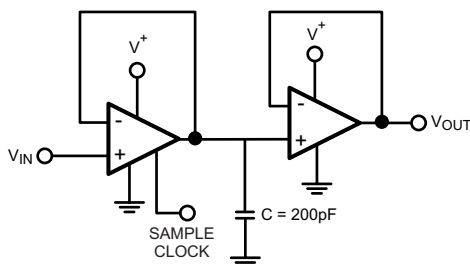

Copyright © 2016, Texas Instruments Incorporated

3 Description

The LMV34x-N devices are single, dual, and quad low-voltage, low-power operational amplifiers. They are designed specifically for low-voltage portable applications. Other important product characteristics are low input bias current, rail-to-rail output, and wide temperature range.

The patented class AB turnaround stage significantly reduces the noise at higher frequencies, power consumption, and offset voltage. The PMOS input stage provides the user with ultra-low input bias current of 20 fA (typical) and high input impedance.

The industrial-plus temperature range of -40°C to 125°C allows the LMV34x-N to accommodate a broad range of extended environment applications. LMV341-N expands Texas Instrument's Silicon Dust amplifier portfolio offering enhancements in size, speed, and power savings. The LMV34x-N devices are specified to operate over the voltage range of 2.7 V to 5.5 V and all have rail-to-rail output.

The LMV341-N offers a shutdown pin that can be used to disable the device. Once in shutdown mode, the supply current is reduced to 45 pA (typical). The LMV34x-N devices have 29-nV voltage noise at 10 KHz, 1 MHz GBW, 1-V/μs slew rate, 0.25 mVos, and 0.1-μA shutdown current (LMV341-N).

The LMV341-N is offered in the tiny 6-pin SC70 package, the LMV342-N in space-saving 8-pin VSSOP and SOIC packages, and the LMV344-N in 14-pin TSSOP and SOIC packages. These small package amplifiers offer an ideal solution for applications requiring minimum PCB footprint. Applications with area constrained PCB requirements include portable electronics such as cellular handsets and PDAs.

Device Information⁽¹⁾

PART NUMBER	PACKAGE	BODY SIZE (NOM)
LMV341-N	SC70 (6)	2.00 mm × 1.25 mm
LMV342-N	VSSOP (8)	3.00 mm × 3.00 mm
	SOIC (8)	4.90 mm × 3.91 mm
LMV344-N	TSSOP (14)	5.00 mm × 4.40 mm
	SOIC (14)	8.64 mm × 3.91 mm

(1) For all available packages, see the orderable addendum at the end of the data sheet.



Table of Contents

1 Features	1	7.4 Device Functional Modes.....	16
2 Applications	1	8 Application and Implementation	18
3 Description	1	8.1 Application Information.....	18
4 Revision History	2	8.2 Typical Application	18
5 Pin Configuration and Functions	3	9 Power Supply Recommendations	19
6 Specifications	5	10 Layout	20
6.1 Absolute Maximum Ratings	5	10.1 Layout Guidelines	20
6.2 ESD Ratings.....	5	10.2 Layout Example	20
6.3 Recommended Operating Conditions.....	5	11 Device and Documentation Support	21
6.4 Thermal Information	5	11.1 Device Support.....	21
6.5 Electrical Characteristics – 2.7 V (DC)	6	11.2 Documentation Support	21
6.6 Electrical Characteristics – 2.7 V (AC).....	7	11.3 Related Links	21
6.7 Electrical Characteristics – 5 V (DC)	7	11.4 Receiving Notification of Documentation Updates	21
6.8 Electrical Characteristics – 5 V (AC).....	8	11.5 Community Resources.....	21
6.9 Typical Characteristics.....	9	11.6 Trademarks	21
7 Detailed Description	16	11.7 Electrostatic Discharge Caution.....	21
7.1 Overview	16	11.8 Glossary	22
7.2 Functional Block Diagram	16	12 Mechanical, Packaging, and Orderable	22
7.3 Feature Description.....	16	Information	22

4 Revision History

NOTE: Page numbers for previous revisions may differ from page numbers in the current version.

Changes from Revision G (March 2013) to Revision H	Page
• Added <i>ESD Ratings</i> table, <i>Feature Description</i> section, <i>Device Functional Modes</i> , <i>Application and Implementation</i> section, <i>Power Supply Recommendations</i> section, <i>Layout</i> section, <i>Device and Documentation Support</i> section, and <i>Mechanical, Packaging, and Orderable Information</i> section	1
• Changed <i>Thermal Information</i> table	5

Changes from Revision F (March 2012) to Revision G	Page
• Changed layout of National Data Sheet to TI format	1

5 Pin Configuration and Functions

**DCK Package
6-Pin SC70
Top View**

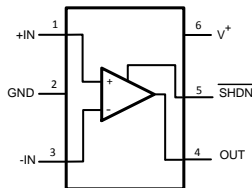

Pin Functions – LMV341-N

PIN		TYPE ⁽¹⁾	DESCRIPTION
NAME	NO.		
+IN	1	I	Noninverting input
-IN	3	I	Inverting input
GND	2	P	Negative supply input
OUT	4	O	Output
V ⁺	6	P	Positive supply input
SHDN	5	I	Active low enable input

(1) I = Input, O = Output, and P = Power

**DGK or D Package
8-Pin VSSOP or SOIC
Top View**

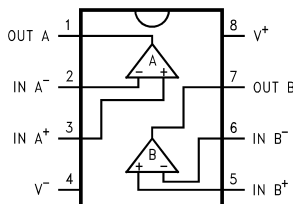

Pin Functions – LMV342-N

PIN		TYPE ⁽¹⁾	DESCRIPTION
NAME	NO.		
IN A ⁺	3	I	Noninverting input, channel A
IN A ⁻	2	I	Inverting input, channel A
IN B ⁺	5	I	Noninverting input, channel B
IN B ⁻	6	I	Inverting input, channel B
OUT A	1	O	Output, channel A
OUT B	7	O	Output, channel B
V ⁺	8	P	Positive (highest) power supply
V ⁻	4	P	Negative (lowest) power supply

(1) I = Input, O = Output, and P = Power

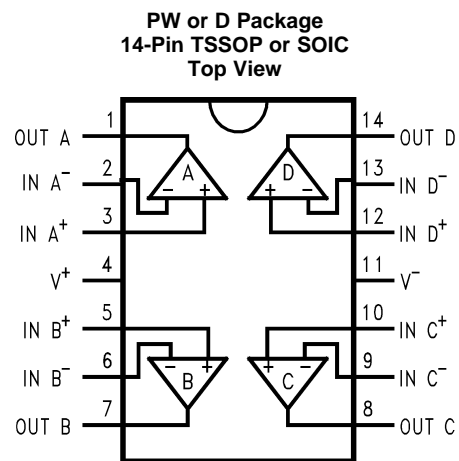
Pin Functions – LMV344-N

PIN		TYPE ⁽¹⁾	DESCRIPTION
NAME	NO.		
IN A ⁺	3	I	Noninverting input, channel A
IN A ⁻	2	I	Inverting input, channel A
IN B ⁺	5	I	Noninverting input, channel B
IN B ⁻	6	I	Inverting input, channel B
IN C ⁺	10	I	Noninverting input, channel C
IN C ⁻	9	I	Inverting input, channel C
IN D ⁺	12	I	Noninverting input, channel D
IN D ⁻	13	I	Inverting input, channel D
OUT A	1	O	Output, channel A
OUT B	7	O	Output, channel B
OUT C	8	O	Output, channel C
OUT D	14	O	Output, channel D
V ⁺	4	P	Positive (highest) power supply
V ⁻	11	P	Negative (lowest) power supply

(1) I = Input, O = Output, and P = Power

6 Specifications

6.1 Absolute Maximum Ratings

over operating free-air temperature range (unless otherwise noted)⁽¹⁾⁽²⁾

		MIN	MAX	UNIT
Differential input voltage		±Supply voltage		
Supply voltage ($V^+ - V^-$)		6		V
Output short circuit to V^+		See ⁽³⁾		
Output short circuit to V^-		See ⁽⁴⁾		
Lead temperature	Infrared or convection reflow (20 s)	235		°C
	Wave soldering (10 s)	260		
Junction temperature, T_J ⁽⁵⁾		150		°C
Storage temperature, T_{stg}		-65	150	°C

- Stresses beyond those listed under *Absolute Maximum Ratings* may cause permanent damage to the device. These are stress ratings only, which do not imply functional operation of the device at these or any other conditions beyond those indicated under *Recommended Operating Conditions*. Exposure to absolute-maximum-rated conditions for extended periods may affect device reliability.
- If Military/Aerospace specified devices are required, please contact the Texas Instruments Sales Office/Distributors for availability and specifications.
- Shorting output to V^+ will adversely affect reliability.
- Shorting output to V^- will adversely affect reliability.
- The maximum power dissipation is a function of $T_{J(MAX)}$, $R_{\theta JA}$. The maximum allowable power dissipation at any ambient temperature is $P_D = (T_{J(MAX)} - T_A) / R_{\theta JA}$. All numbers apply for packages soldered directly onto a PCB.

6.2 ESD Ratings

		VALUE	UNIT
$V_{(ESD)}$ Electrostatic discharge	Human-body model (HBM) ⁽¹⁾	±2000	V
	Machine model (MM) ⁽²⁾	±200	

- Human Body Model, applicable std. MIL-STD-883, Method 3015.7.
- Machine Model, applicable std. JESD22-A115-A (ESD MM std. of JEDEC) Field-Induced Charge-Device Model, applicable std. JESD22-C101-C (ESD FICDM std. of JEDEC).

6.3 Recommended Operating Conditions

over operating free-air temperature range (unless otherwise noted)

		MIN	MAX	UNIT
Supply voltage		2.7	5.5	V
Temperature		-40	125	°C

6.4 Thermal Information

THERMAL METRIC ⁽¹⁾		LMV341-N	LMV342-N		LMV344-N		UNIT
		DCK (SC70)	D (SOIC)	DGK (VSSOP)	D (SOIC)	PW (TSSOP)	
		6 PINS	8 PINS	8 PINS	14 PINS	14 PINS	
$R_{\theta JA}$	Junction-to-ambient thermal resistance	414	190	235	145	155	°C/W
$R_{\theta JC(top)}$	Junction-to-case (top) thermal resistance	116.1	65.2	68.4	45.9	50.5	°C/W
$R_{\theta JB}$	Junction-to-board thermal resistance	53.3	61.4	98.8	44.1	66.2	°C/W
Ψ_{JT}	Junction-to-top characterization parameter	8.8	16.1	9.8	10.2	6.3	°C/W
Ψ_{JB}	Junction-to-board characterization parameter	52.7	60.8	97.3	43.7	65.6	°C/W
$R_{\theta JC(bot)}$	Junction-to-case (bottom) thermal resistance	—	—	—	—	—	°C/W

- For more information about traditional and new thermal metrics, see the [Semiconductor and IC Package Thermal Metrics](#) application report.

6.5 Electrical Characteristics – 2.7 V (DC)

 $T_J = 25^\circ\text{C}$, $V^+ = 2.7\text{ V}$, $V^- = 0\text{ V}$, $V_{CM} = V^+/2$, $V_O = V^+/2$, and $R_L > 1\text{ M}\Omega$ (unless otherwise noted)⁽¹⁾

PARAMETER		TEST CONDITIONS		MIN ⁽²⁾	TYP ⁽³⁾	MAX ⁽²⁾	UNIT
V_{OS}	Input offset voltage	LMV341-N	$T_J = 25^\circ\text{C}$		0.25	4	mV
			$-40^\circ\text{C} \leq T_J \leq 125^\circ\text{C}$			4.5	
		LMV342-N and LMV344-N	$T_J = 25^\circ\text{C}$		0.55	5	
			$-40^\circ\text{C} \leq T_J \leq 125^\circ\text{C}$			5.5	
TCV_{OS}	Input offset voltage average drift			1.7		$\mu\text{V}/^\circ\text{C}$	
I_B	Input bias current	$T_J = 25^\circ\text{C}$			0.02	120	μA
		$-40^\circ\text{C} \leq T_J \leq 150^\circ\text{C}$				250	
I_{OS}	Input offset current				6.6		fA
I_S	Supply current	Per amplifier	$T_J = 25^\circ\text{C}$		100	170	μA
			$-40^\circ\text{C} \leq T_J \leq 125^\circ\text{C}$			230	
		Shutdown mode, $V_{SD} = 0\text{ V}$, LMV341-N	$T_J = 25^\circ\text{C}$		4.5×10^{-5}	1	
			$-40^\circ\text{C} \leq T_J \leq 125^\circ\text{C}$			1.5	
CMRR	Common-mode rejection ratio	$0\text{ V} \leq V_{CM} \leq 1.7\text{ V}$, $0\text{ V} \leq V_{CM} \leq 1.6\text{ V}$	$T_J = 25^\circ\text{C}$	56	80	dB	
			$-40^\circ\text{C} \leq T_J \leq 125^\circ\text{C}$	50			
PSRR	Power supply rejection ratio	$2.7\text{ V} \leq V^+ \leq 5\text{ V}$	$T_J = 25^\circ\text{C}$	65	82	dB	
			$-40^\circ\text{C} \leq T_J \leq 125^\circ\text{C}$	60			
V_{CM}	Input common-mode voltage	For CMRR $\geq 50\text{ dB}$	V+		1.9	1.7	V
			V-		0	-0.2	
A_V	Large signal voltage gain	$R_L = 10\text{ k}\Omega$ to 1.35 V	$T_J = 25^\circ\text{C}$	78	113	dB	
			$-40^\circ\text{C} \leq T_J \leq 125^\circ\text{C}$	70			
		$R_L = 2\text{ k}\Omega$ to 1.35 V	$T_J = 25^\circ\text{C}$	72	103		
			$-40^\circ\text{C} \leq T_J \leq 125^\circ\text{C}$	64			
V_O	Output swing	$R_L = 2\text{ k}\Omega$ to 1.35 V	$T_J = 25^\circ\text{C}$		24	60	mV
			$-40^\circ\text{C} \leq T_J \leq 125^\circ\text{C}$			95	
			$T_J = 25^\circ\text{C}$	60	26		
			$-40^\circ\text{C} \leq T_J \leq 125^\circ\text{C}$	95			
		$R_L = 10\text{ k}\Omega$ to 1.35 V	$T_J = 25^\circ\text{C}$		5	30	
			$-40^\circ\text{C} \leq T_J \leq 125^\circ\text{C}$			40	
			$T_J = 25^\circ\text{C}$	30	5.3		
			$-40^\circ\text{C} \leq T_J \leq 125^\circ\text{C}$	40			
I_O	Output short-circuit current	Sourcing, LMV341-N and LMV342-N		20	32	mA	
		Sourcing, LMV344-N		18	24		
		Sinking		15	24		
t_{on}	Turnon time from shutdown	LMV341-N			5	μs	
V_{SD}	Shutdown pin voltage	ON mode, LMV341-N		2.4	1.7	2.7	V
		Shutdown mode, LMV341-N		0	1	0.8	

- (1) Electrical characteristic values apply only for factory testing conditions at the temperature indicated. Factory testing conditions result in very limited self-heating of the device such that $T_J = T_A$. No specification of parametric performance is indicated in the electrical tables under conditions of internal self heating where $T_J > T_A$.
- (2) All limits are specified by testing or statistical analysis.
- (3) Typical values represent the most likely parametric norm as determined at the time of characterization. Actual typical values may vary over time and also depends on the application and configuration. The typical values are not tested and are not ensured on shipped production material.

6.6 Electrical Characteristics – 2.7 V (AC)

 $T_J = 25^\circ\text{C}$, $V^+ = 2.7\text{V}$, $V^- = 0\text{V}$, $V_{\text{CM}} = V^+ / 2$, $V_O = V^+ / 2$, and $R_L > 1\text{ M}\Omega$ (unless otherwise noted)⁽¹⁾

PARAMETER		TEST CONDITIONS	MIN ⁽²⁾	TYP ⁽³⁾	MAX ⁽²⁾	UNIT
SR	Slew rate	$R_L = 10\text{ k}\Omega$ ⁽⁴⁾		1		V/ μs
GBW	Gain bandwidth product	$R_L = 100\text{ k}\Omega$, $C_L = 200\text{ pF}$		1		MHz
Φ_m	Phase margin	$R_L = 100\text{ k}\Omega$		72		°
G_m	Gain margin	$R_L = 100\text{ k}\Omega$		20		dB
e_n	Input-referred voltage noise	$f = 1\text{ kHz}$		40		nV/ $\sqrt{\text{Hz}}$
i_n	Input-referred current noise	$f = 1\text{ kHz}$		0.001		pA/ $\sqrt{\text{Hz}}$
THD	Total harmonic distortion	$f = 1\text{ kHz}$, $A_V = +1$, $R_L = 600\ \Omega$, $V_{\text{IN}} = 1V_{\text{PP}}$		0.017%		

- (1) Electrical characteristic values apply only for factory testing conditions at the temperature indicated. Factory testing conditions result in very limited self-heating of the device such that $T_J = T_A$. No specification of parametric performance is indicated in the electrical tables under conditions of internal self heating where $T_J > T_A$.
- (2) All limits are specified by testing or statistical analysis.
- (3) Typical values represent the most likely parametric norm as determined at the time of characterization. Actual typical values may vary over time and also depends on the application and configuration. The typical values are not tested and are not ensured on shipped production material.
- (4) Connected as voltage follower with 2- V_{PP} step input. Number specified is the slower of the positive and negative slew rates.

6.7 Electrical Characteristics – 5 V (DC)

 $T_J = 25^\circ\text{C}$, $V^+ = 5\text{ V}$, $V^- = 0\text{ V}$, $V_{\text{CM}} = V^+ / 2$, $V_O = V^+ / 2$, and $R_L > 1\text{ M}\Omega$ (unless otherwise noted)⁽¹⁾

PARAMETER		TEST CONDITIONS	MIN ⁽²⁾	TYP ⁽³⁾	MAX ⁽²⁾	UNIT
V_{OS}	Input offset voltage	LMV341-N	$T_J = 25^\circ\text{C}$	0.025	4	mV
			$-40^\circ\text{C} \leq T_J \leq 125^\circ\text{C}$		4.5	
		LMV342-N and LMV344-N	$T_J = 25^\circ\text{C}$	0.7	5	
			$-40^\circ\text{C} \leq T_J \leq 125^\circ\text{C}$		5.5	
TCV_{OS}	Input offset voltage average drift		1.9		$\mu\text{V}/^\circ\text{C}$	
I_B	Input bias current	$T_J = 25^\circ\text{C}$		0.02	200	pA
		$-40^\circ\text{C} \leq T_J \leq 125^\circ\text{C}$			375	
I_{OS}	Input offset current			6.6		fA
I_S	Supply current	Per amplifier	$T_J = 25^\circ\text{C}$	107	200	μA
			$-40^\circ\text{C} \leq T_J \leq 125^\circ\text{C}$		260	
		Shutdown mode, $V_{\text{SD}} = 0\text{ V}$, LMV341-N	$T_J = 25^\circ\text{C}$	0.033	1	
			$-40^\circ\text{C} \leq T_J \leq 125^\circ\text{C}$		1.5	
CMRR	Common-mode rejection ratio	$0\text{ V} \leq V_{\text{CM}} \leq 4\text{ V}$, $0\text{ V} \leq V_{\text{CM}} \leq 3.9\text{ V}$	$T_J = 25^\circ\text{C}$	56	86	dB
			$-40^\circ\text{C} \leq T_J \leq 125^\circ\text{C}$	50		
PSRR	Power supply rejection ratio	$2.7\text{ V} \leq V^+ \leq 5\text{ V}$	$T_J = 25^\circ\text{C}$	65	82	dB
			$-40^\circ\text{C} \leq T_J \leq 125^\circ\text{C}$	60		
V_{CM}	Input common-mode voltage	For CMRR $\geq 50\text{ dB}$	V+	4.2	4	V
			V-	0	-0.2	
A_V	Large signal voltage gain ⁽⁴⁾	$R_L = 10\text{ k}\Omega$ to 2.5 V	$T_J = 25^\circ\text{C}$	78	116	dB
			$-40^\circ\text{C} \leq T_J \leq 125^\circ\text{C}$	70		
		$R_L = 2\text{ k}\Omega$ to 2.5 V	$T_J = 25^\circ\text{C}$	72	107	
			$-40^\circ\text{C} \leq T_J \leq 125^\circ\text{C}$	64		

- (1) Electrical characteristic values apply only for factory testing conditions at the temperature indicated. Factory testing conditions result in very limited self-heating of the device such that $T_J = T_A$. No specification of parametric performance is indicated in the electrical tables under conditions of internal self heating where $T_J > T_A$.
- (2) All limits are specified by testing or statistical analysis.
- (3) Typical values represent the most likely parametric norm as determined at the time of characterization. Actual typical values may vary over time and also depends on the application and configuration. The typical values are not tested and are not ensured on shipped production material.
- (4) R_L is connected to mid-supply. The output voltage is $\text{GND} + 0.2\text{ V} \leq V_O \leq V^+ - 0.2\text{ V}$

Electrical Characteristics – 5 V (DC) (continued)

 $T_J = 25^\circ\text{C}$, $V^+ = 5\text{ V}$, $V^- = 0\text{ V}$, $V_{\text{CM}} = V^+/2$, $V_O = V^+/2$, and $R_L > 1\text{ M}\Omega$ (unless otherwise noted)⁽¹⁾

PARAMETER		TEST CONDITIONS	MIN ⁽²⁾	TYP ⁽³⁾	MAX ⁽²⁾	UNIT		
V_O	Output swing	$R_L = 2\text{ k}\Omega$ to 2.5 V	$T_J = 25^\circ\text{C}$	32	60	mV		
			$-40^\circ\text{C} \leq T_J \leq 125^\circ\text{C}$		95			
		$R_L = 10\text{ k}\Omega$ to 2.5 V	$T_J = 25^\circ\text{C}$	60	34			
			$-40^\circ\text{C} \leq T_J \leq 125^\circ\text{C}$	95				
			$T_J = 25^\circ\text{C}$		7			30
			$-40^\circ\text{C} \leq T_J \leq 125^\circ\text{C}$					40
I_O	Output short-circuit current	Sourcing	85	113	mA			
		Sinking	50	75				
t_{on}	Turnon time from shutdown	LMV341-N		5	μs			
V_{SD}	Shutdown pin voltage	ON mode, LMV341-N	4.5	3.1	5	V		
		Shutdown mode, LMV341-N	0	1	0.8			

6.8 Electrical Characteristics – 5 V (AC)

 $T_J = 25^\circ\text{C}$, $V^+ = 5\text{ V}$, $V^- = 0\text{ V}$, $V_{\text{CM}} = V^+/2$, $V_O = V^+/2$ and $R_L > 1\text{ M}\Omega$ (unless otherwise noted)⁽¹⁾

PARAMETER		CONDITIONS	MIN ⁽²⁾	TYP ⁽³⁾	MAX ⁽²⁾	UNIT
SR	Slew rate	$R_L = 10\text{ k}\Omega$ ⁽⁴⁾		1		$\text{V}/\mu\text{s}$
GBW	Gain-bandwidth product	$R_L = 10\text{ k}\Omega$, $C_L = 200\text{ pF}$		1		MHz
Φ_m	Phase margin	$R_L = 100\text{ k}\Omega$		70		deg
G_m	Gain margin	$R_L = 100\text{ k}\Omega$		20		dB
e_n	Input-referred voltage noise	$f = 1\text{ kHz}$		39		$\text{nV}/\sqrt{\text{Hz}}$
i_n	Input-referred current noise	$f = 1\text{ kHz}$		0.001		$\text{pA}/\sqrt{\text{Hz}}$
THD	Total harmonic distortion	$f = 1\text{ kHz}$, $A_V = +1$, $R_L = 600\ \Omega$, $V_{\text{IN}} = 1V_{\text{PP}}$		0.012%		

- Electrical characteristic values apply only for factory testing conditions at the temperature indicated. Factory testing conditions result in very limited self-heating of the device such that $T_J = T_A$. No specification of parametric performance is indicated in the electrical tables under conditions of internal self heating where $T_J > T_A$.
- All limits are specified by testing or statistical analysis.
- Typical values represent the most likely parametric norm as determined at the time of characterization. Actual typical values may vary over time and also depends on the application and configuration. The typical values are not tested and are not ensured on shipped production material.
- Connected as voltage follower with $2 \cdot V_{\text{PP}}$ step input. Number specified is the slower of the positive and negative slew rates.

6.9 Typical Characteristics

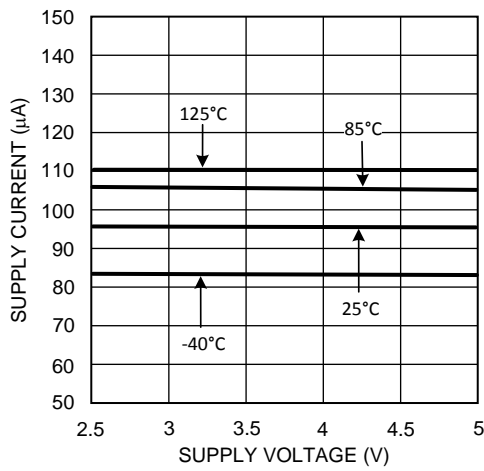

Figure 1. Supply Current vs Supply Voltage (LMV341-N)

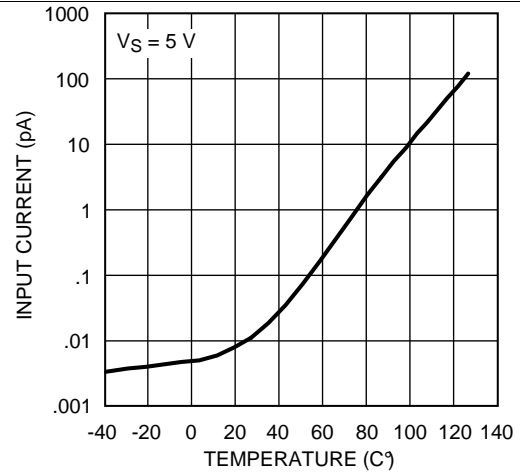

Figure 2. Input Current vs Temperature

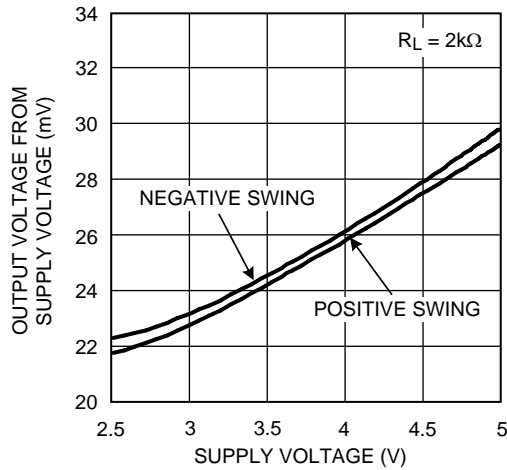

Figure 3. Output Voltage Swing vs Supply Voltage

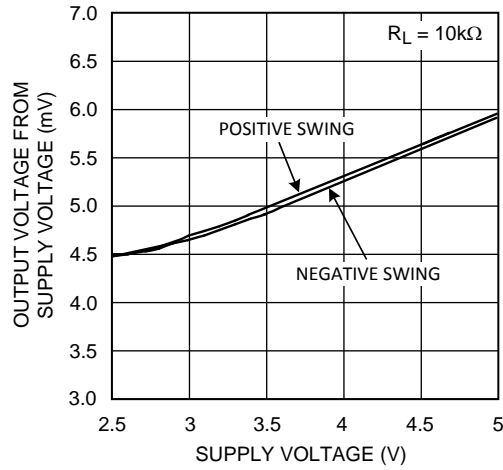

Figure 4. Output Voltage Swing vs Supply Voltage

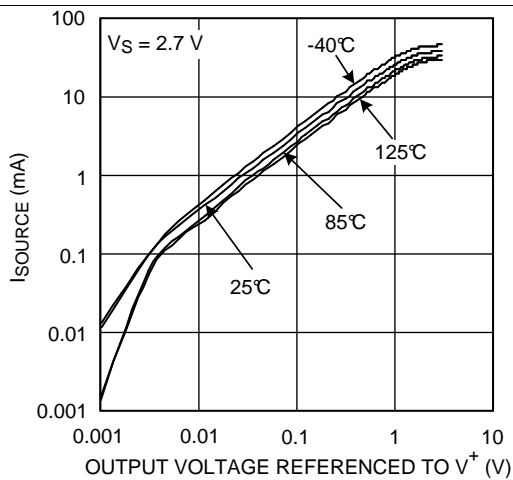

Figure 5. I_{SOURCE} vs V_{OUT}

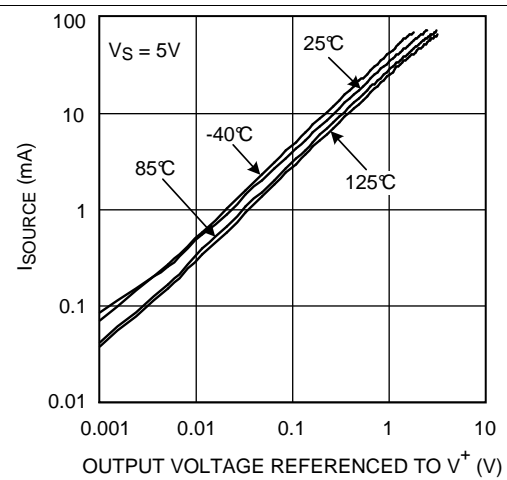

Figure 6. I_{SOURCE} vs V_{OUT}

Typical Characteristics (continued)

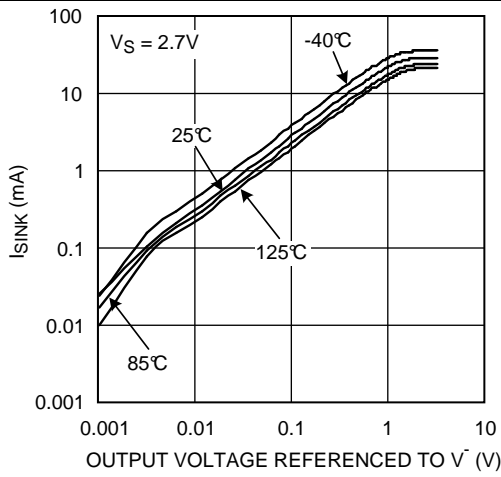

Figure 7. I_{SINK} vs V_{OUT}

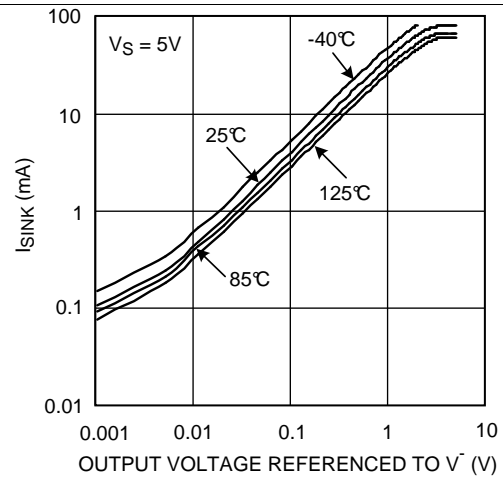

Figure 8. I_{SINK} vs V_{OUT}

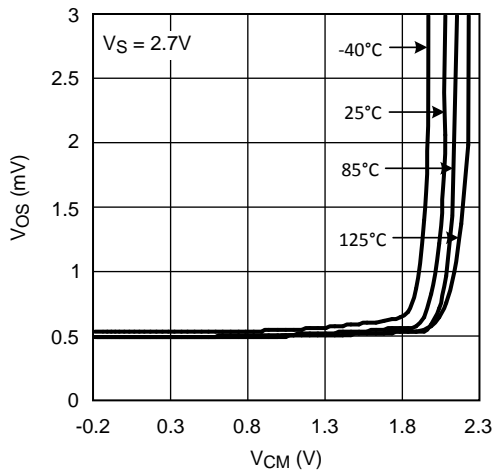

Figure 9. V_{OS} vs V_{CM}

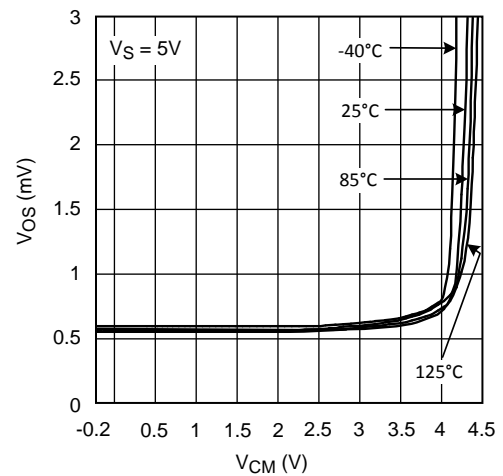

Figure 10. V_{OS} vs V_{CM}

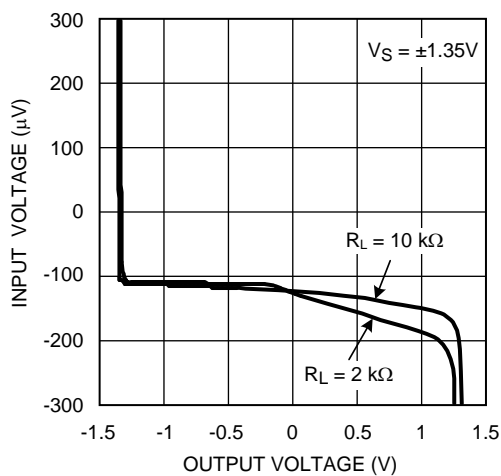

Figure 11. V_{IN} vs V_{OUT}

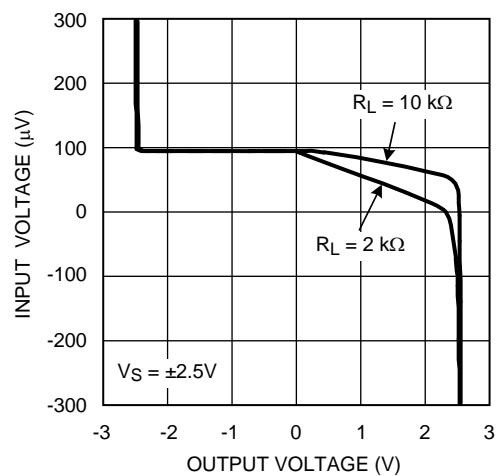

Figure 12. V_{IN} vs V_{OUT}

Typical Characteristics (continued)

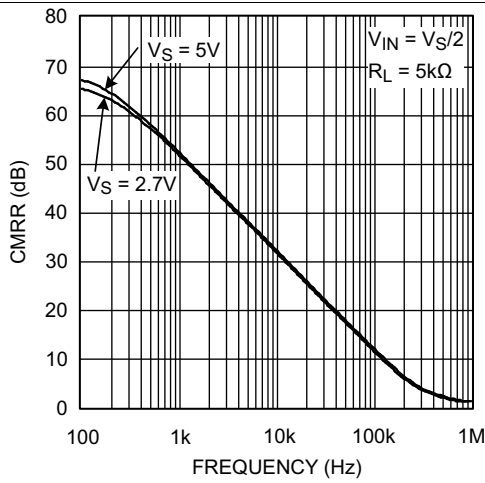

Figure 13. CMRR vs Frequency

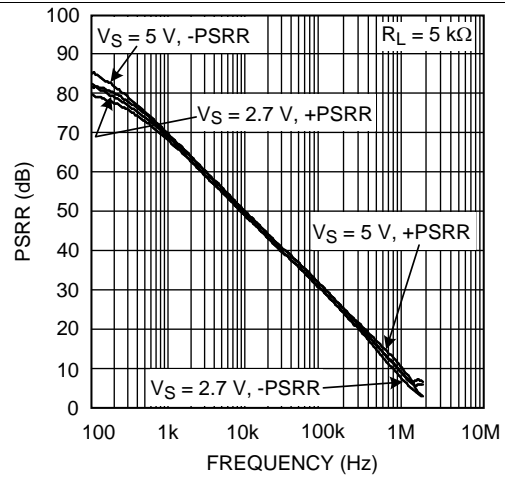

Figure 14. PSRR vs Frequency

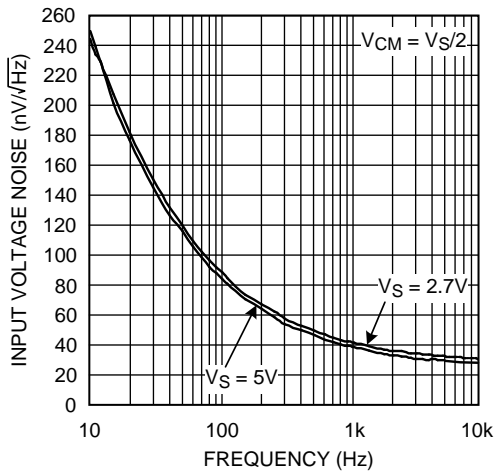

Figure 15. Input Voltage Noise vs Frequency

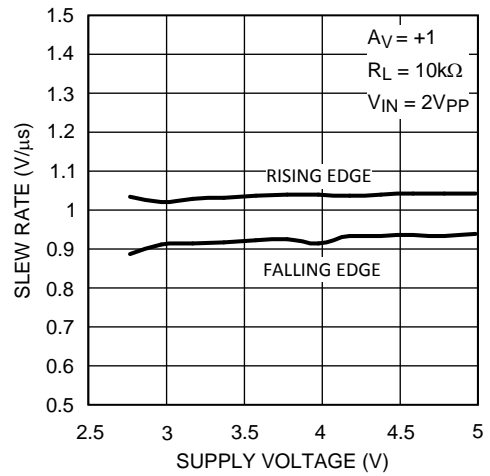

Figure 16. Slew Rate vs VSUPPLY

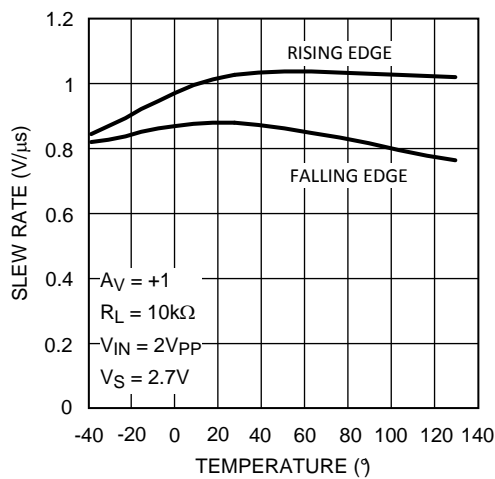

Figure 17. Slew Rate vs Temperature

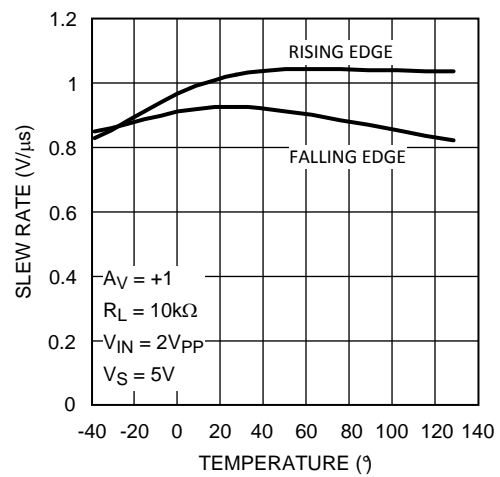

Figure 18. Slew Rate vs Temperature

Typical Characteristics (continued)

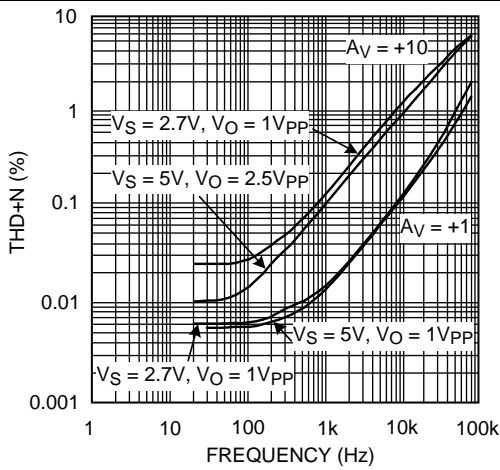

Figure 19. THD+N vs Frequency

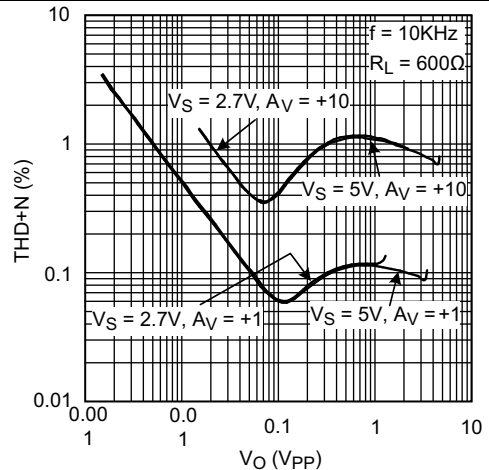

Figure 20. THD+N vs V_{OUT}

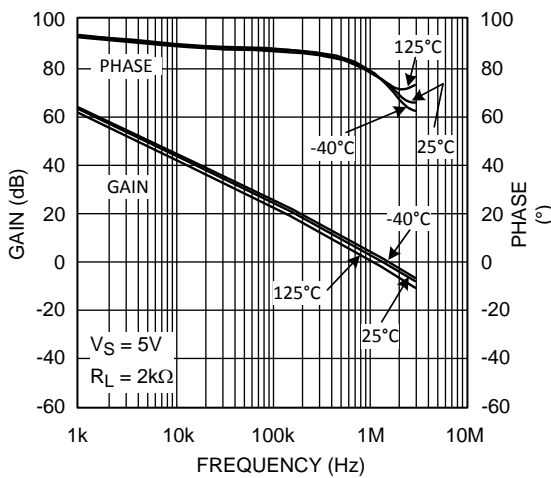

Figure 21. Open-Loop Frequency Over Temperature

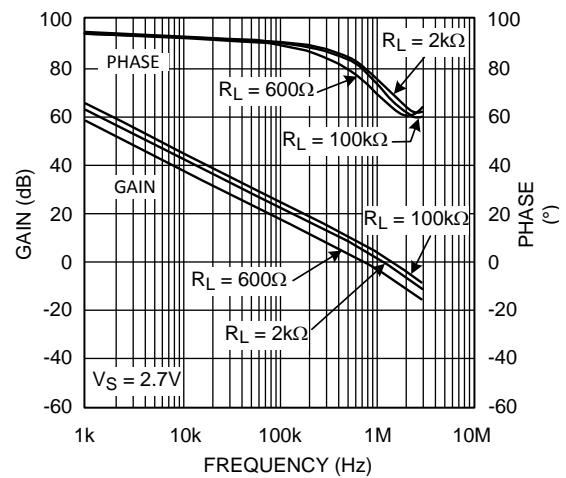

Figure 22. Open-Loop Frequency Response

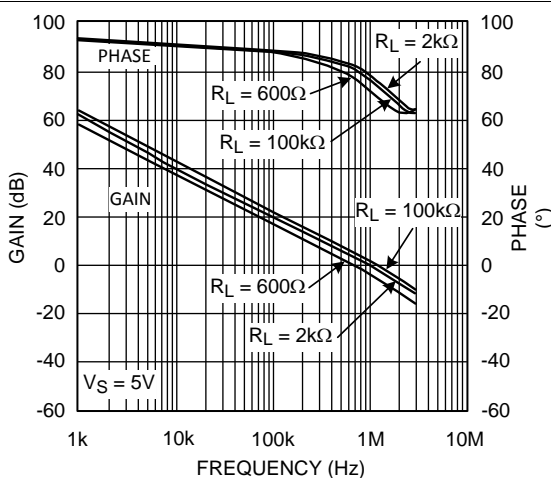

Figure 23. Open-Loop Frequency Response

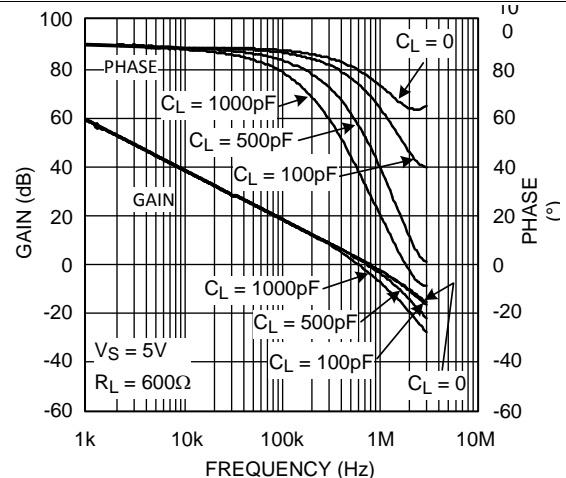

Figure 24. Gain and Phase vs C_L

Typical Characteristics (continued)

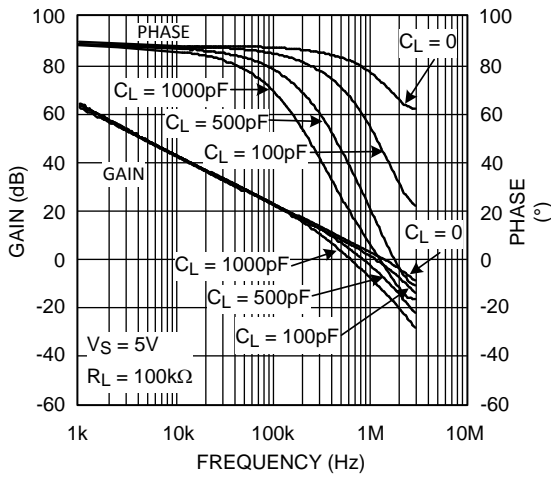

Figure 25. Gain and Phase vs C_L

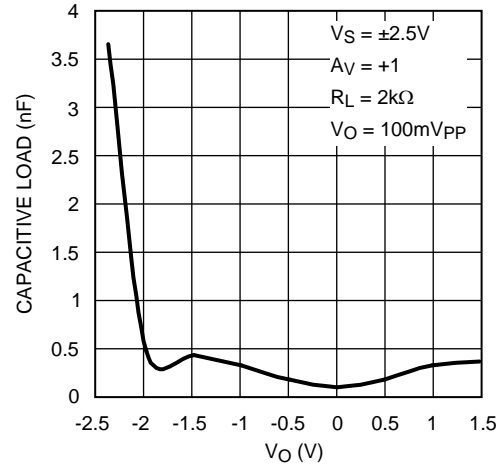

Figure 26. Stability vs Capacitive Load

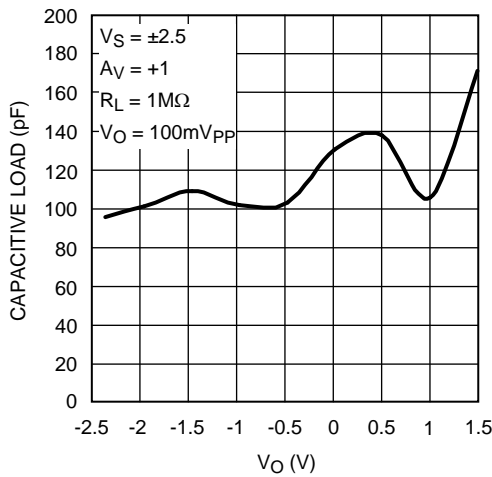

Figure 27. Stability vs Capacitive Load

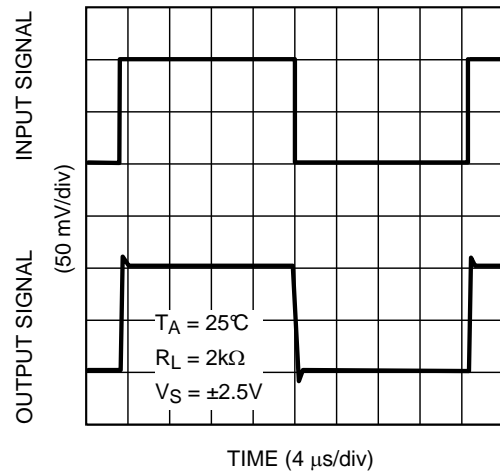

Figure 28. Noninverting Small Signal Pulse Response

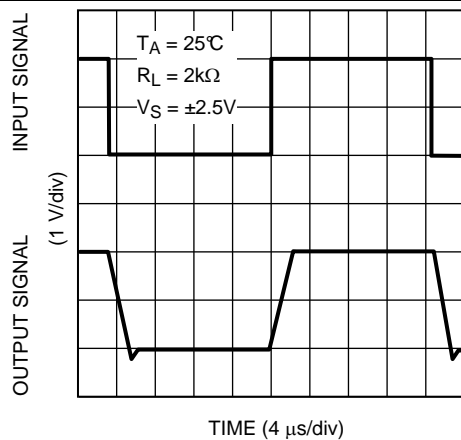

Figure 29. Noninverting Large Signal Pulse Response

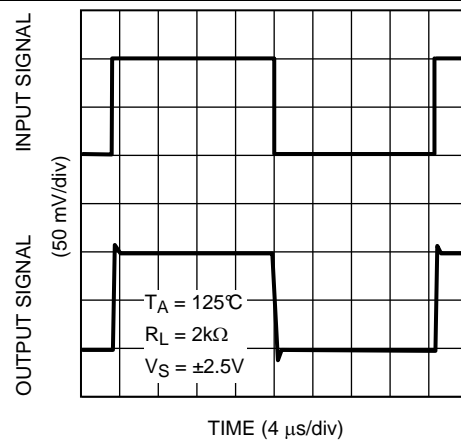
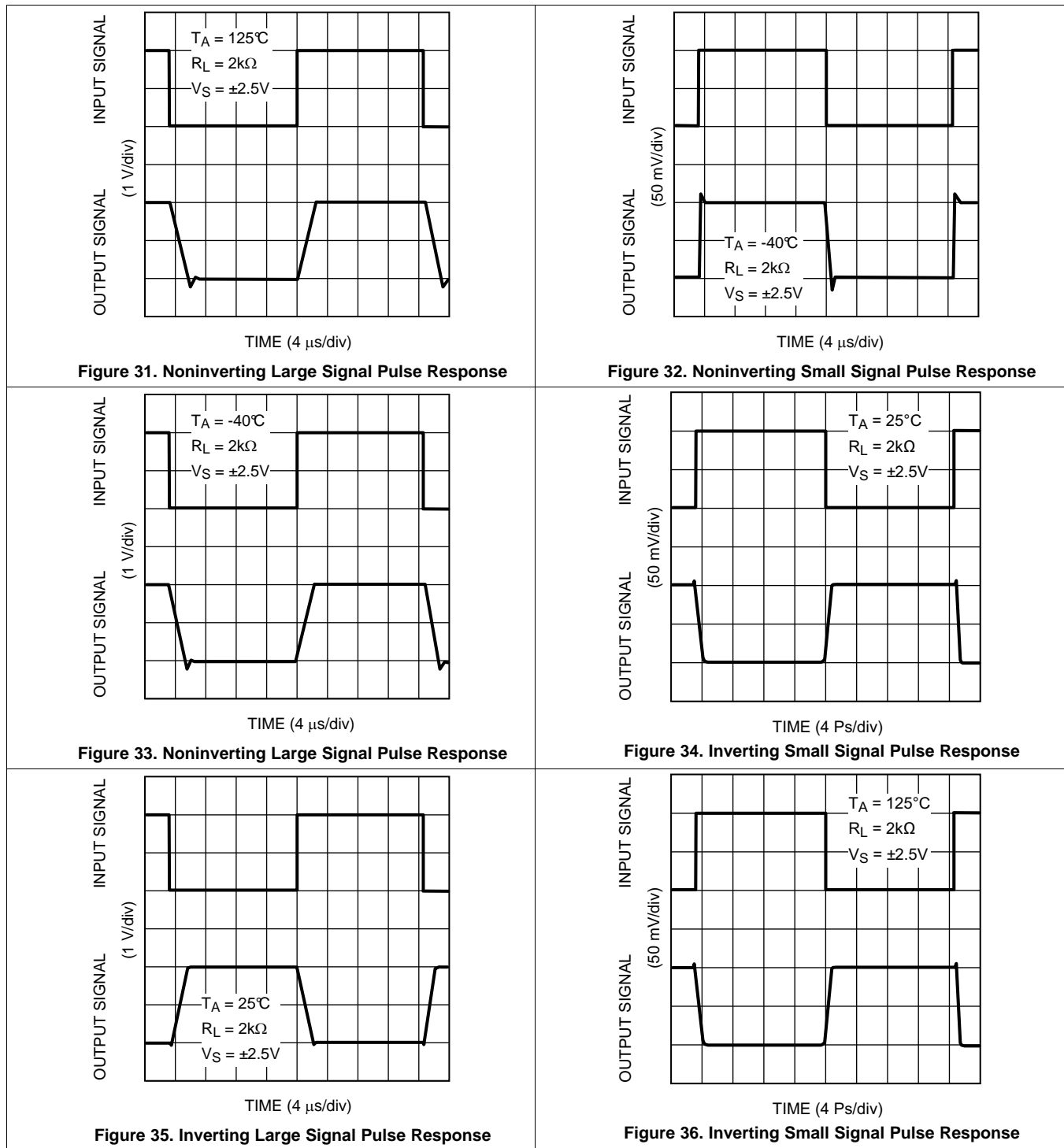

Figure 30. Noninverting Small Signal Pulse Response

Typical Characteristics (continued)

Typical Characteristics (continued)

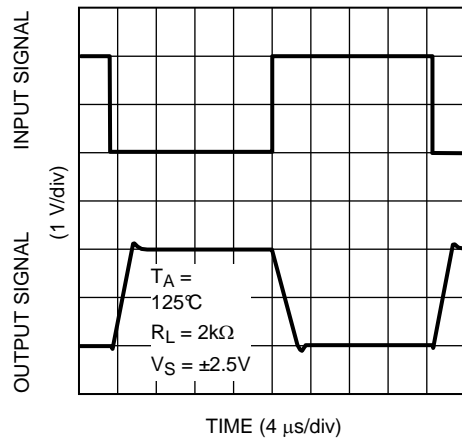

Figure 37. Inverting Large Signal Pulse Response

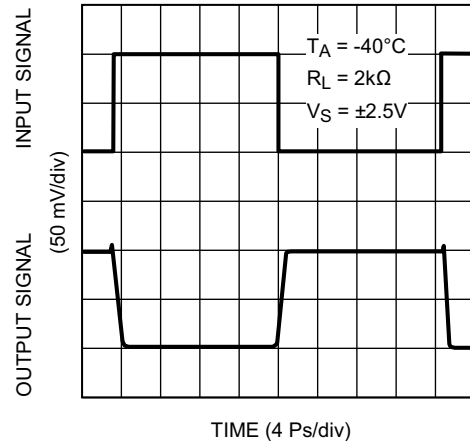

Figure 38. Inverting Small Signal Pulse Response

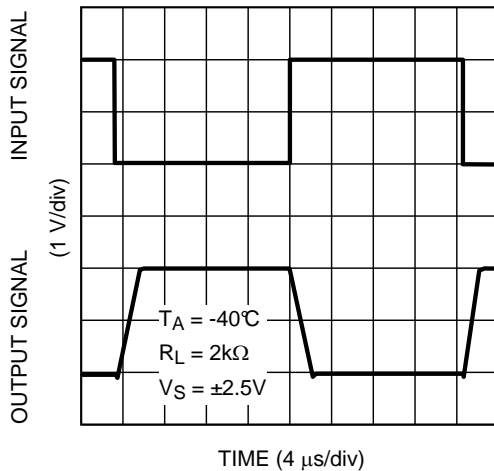

Figure 39. Inverting Large Signal Pulse Response

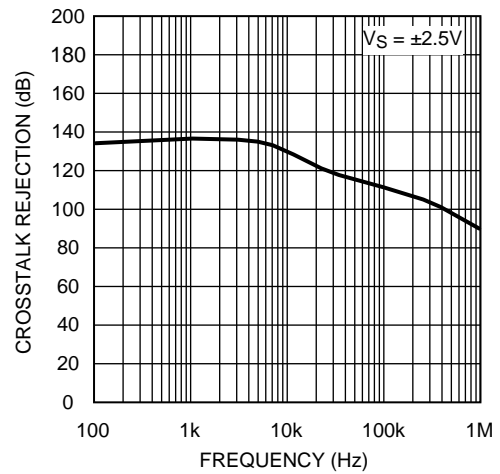

Figure 40. Crosstalk Rejection vs Frequency

7 Detailed Description

7.1 Overview

TI's LMV34x-N family of amplifiers have 1-MHz bandwidth, 1-V/ μ s slew rate, a rail-to-rail output stage, and consume only 100 μ A of current per amplifier while active. When in shutdown mode it only consumes 45-pA supply consumption with only 20 fA of input bias current. Lastly, these operational amplifiers provide an input-referred voltage noise 29 nV $\sqrt{\text{Hz}}$ (at 10 kHz).

7.2 Functional Block Diagram

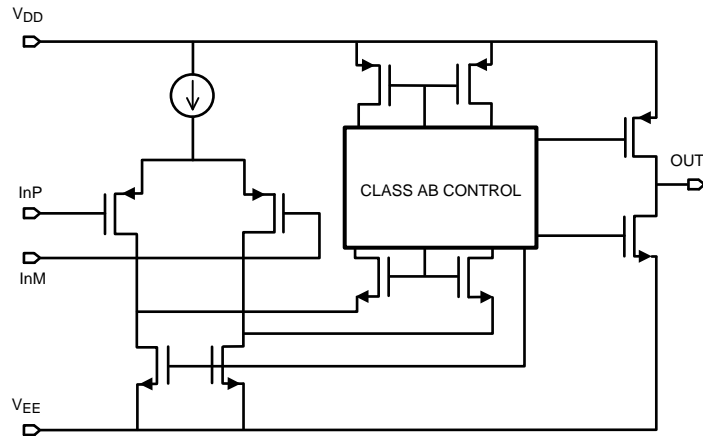

Copyright © 2016, Texas Instruments Incorporated

7.3 Feature Description

7.3.1 Class AB Turnaround Stage Amplifier

This patented folded cascode stage has a combined class AB amplifier stage, which replaces the conventional folded cascode stage. Therefore, the class AB folded cascode stage runs at a much lower quiescent current compared to conventional-folded cascode stages. This results in significantly smaller offset and noise contributions. The reduced offset and noise contributions in turn reduce the offset voltage level and the voltage noise level at the input of LMV34x-N. Also the lower quiescent current results in a high open-loop gain for the amplifier. The lower quiescent current does not affect the slew rate of the amplifier nor its ability to handle the total current swing coming from the input stage.

The input voltage noise of the device at low frequencies, below 1 kHz, is slightly higher than devices with a BJT input stage; however, the PMOS input stage results in a much lower input bias current and the input voltage noise drops at frequencies above 1 kHz.

7.4 Device Functional Modes

7.4.1 Shutdown Feature

The LMV341-N is capable of being turned off to conserve power and increase battery life in portable devices. Once in shutdown mode the supply current is drastically reduced, 1- μ A maximum, and the output is *tri-stated*.

The device is disabled when the shutdown pin voltage is pulled low. The shutdown pin must never be left unconnected. Leaving the pin floating results in an undefined operation mode and the device may oscillate between shutdown and active modes.

The LMV341-N typically turns on 2.8 μ s after the shutdown voltage is pulled high. The device turns off in less than 400 ns after shutdown voltage is pulled low. [Figure 41](#) and [Figure 42](#) show the turnon and turnoff time of the LMV341-N, respectively. To reduce the effect of the capacitance added to the circuit by the scope probe, in the turnoff time circuit a resistive load of 600 Ω is added. [Figure 43](#) and [Figure 44](#) show the test circuits used to obtain the two plots.

Device Functional Modes (continued)

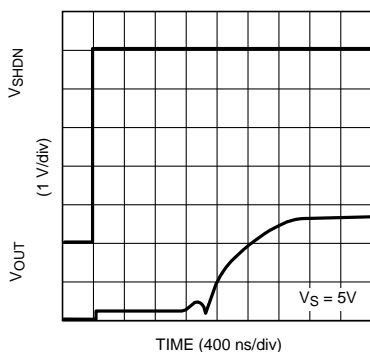

Figure 41. Turnon Time Plot

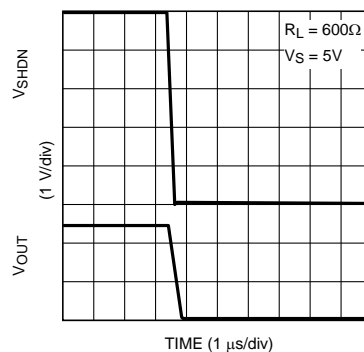

Figure 42. Turnoff Time Plot

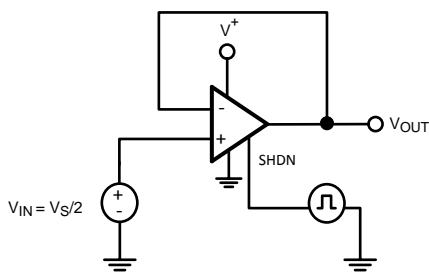

Figure 43. Turnon Time Circuit

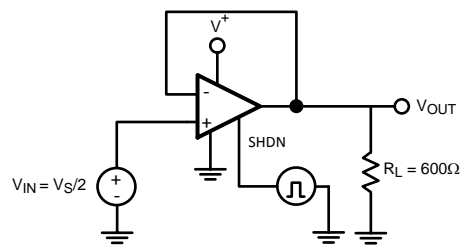

Figure 44. Turnoff Time Circuit

7.4.2 Low Input Bias Current

LMV34x-N amplifiers have a PMOS input stage. As a result, they have a much lower input bias current than devices with BJT input stages. This feature makes these devices ideal for sensor circuits. A typical curve of the input bias current of the LMV341-N is shown in Figure 45.

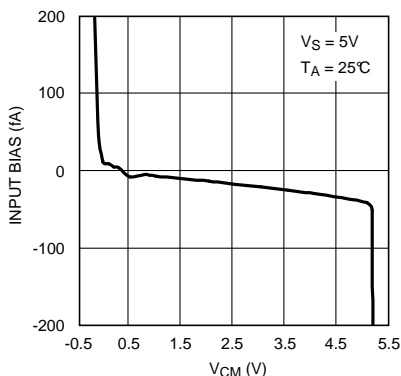

Figure 45. Input Bias Current vs V_{CM}

8 Application and Implementation

NOTE

Information in the following applications sections is not part of the TI component specification, and TI does not warrant its accuracy or completeness. TI's customers are responsible for determining suitability of components for their purposes. Customers should validate and test their design implementation to confirm system functionality.

8.1 Application Information

The LMV34x-N amplifier family features low voltage, low power, rail-to-rail output as well as a shutdown capability, making it well suited for low voltage portable applications.

8.2 Typical Application

8.2.1 Sample and Hold Circuit

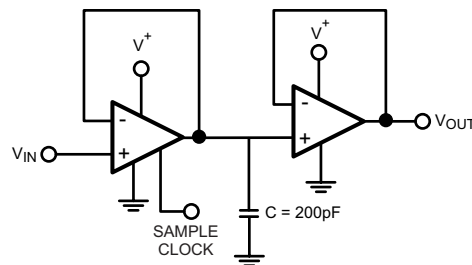

Copyright © 2016, Texas Instruments Incorporated

Figure 46. Sample and Hold Circuit

8.2.1.1 Design Requirements

The lower input bias current of the LMV341-N results in a very high input impedance. The output impedance when the device is in shutdown mode is quite high. These high impedances, along with the ability of the shutdown pin to be derived from a separate power source, make LMV341-N a good choice for sample and hold circuits. The sample clock must be connected to the shutdown pin of the amplifier to rapidly turn the device on or off.

8.2.1.2 Detailed Design Procedure

Figure 46 shows the schematic of a simple sample and hold circuit. When the sample clock is high the first amplifier is in normal operation mode and the second amplifier acts as a buffer. The capacitor, which appears as a load on the first amplifier, is charging at this time. The voltage across the capacitor is that of the noninverting input of the first amplifier because it is connected as a voltage-follower. When the sample clock is low the first amplifier is shut off, bringing the output impedance to a high value. The high impedance of this output, along with the very high impedance on the input of the second amplifier, prevents the capacitor from discharging. There is very little voltage droop while the first amplifier is in shutdown mode. The second amplifier, which is still in normal operation mode and is connected as a voltage follower, also provides the voltage sampled on the capacitor at its output.

Typical Application (continued)

8.2.1.3 Application Curve

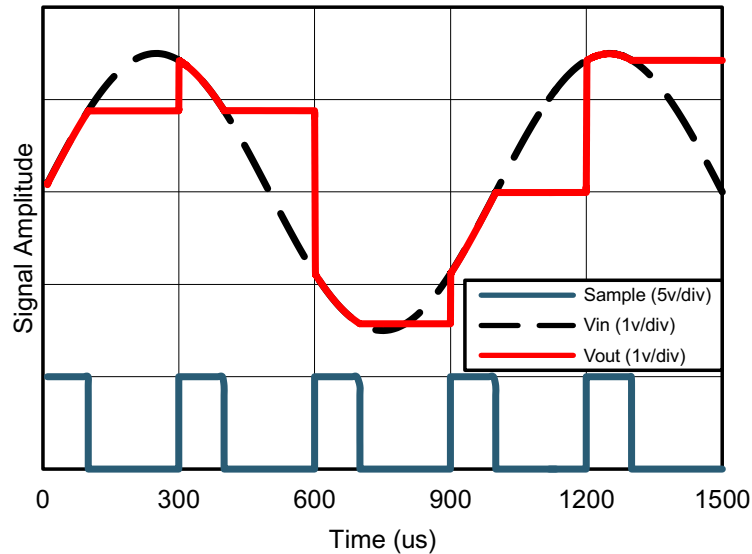

Figure 47. Sample and Hold Circuit Results

9 Power Supply Recommendations

For proper operation, the power supplies must be properly decoupled. For decoupling the supply lines, TI recommends that 10-nF capacitors be placed as close as possible to the op amp power supply pins. For single-supply, place a capacitor between V^+ and V^- supply leads. For dual supplies, place one capacitor between V^+ and ground, and one capacitor between V^- and ground.

10 Layout

10.1 Layout Guidelines

To properly bypass the power supply, several locations on a printed-circuit board need to be considered. A 6.8- μF or greater tantalum capacitor must be placed at the point where the power supply for the amplifier is introduced onto the board. Another 0.1- μF ceramic capacitor must be placed as close as possible to the power supply pin of the amplifier. If the amplifier is operated in a single power supply, only the V^+ pin needs to be bypassed with a 0.1- μF capacitor. If the amplifier is operated in a dual power supply, both V^+ and V^- pins need to be bypassed.

It is good practice to use a ground plane on a printed-circuit board to provide all components with a low inductive ground connection.

Surface-mount components in 0805 size or smaller are recommended in the LMV341-N application circuits. Designers can take advantage of the VSSOP miniature sizes to condense board layout to save space and reduce stray capacitance.

10.2 Layout Example

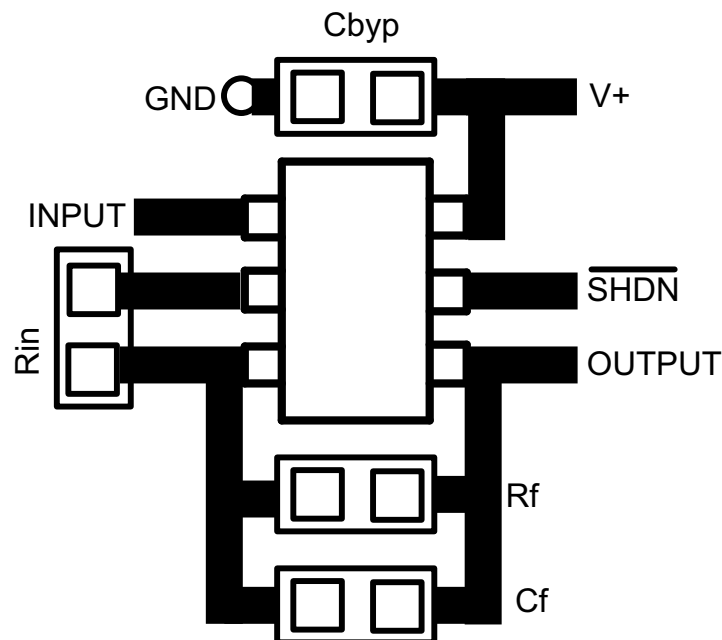

Figure 48. PCB Layout Example

11 Device and Documentation Support

11.1 Device Support

11.1.1 Development Support

For development support see the following:

- [LMV341-N PSPICE Model](#) (also applicable to the LMV342 and LMV344)
- [TINA-TI SPICE-Based Analog Simulation Program](#)
- [DIP Adapter Evaluation Module](#)
- [TI Universal Operational Amplifier Evaluation Module](#)
- [TI Filterpro Software](#)

11.2 Documentation Support

11.2.1 Related Documentation

For related documentation see the following:

[AN-31 Op Amp Circuit Collection](#) (SNLA140)

11.3 Related Links

The table below lists quick access links. Categories include technical documents, support and community resources, tools and software, and quick access to sample or buy.

Table 1. Related Links

PARTS	PRODUCT FOLDER	SAMPLE & BUY	TECHNICAL DOCUMENTS	TOOLS & SOFTWARE	SUPPORT & COMMUNITY
LMV341-N	Click here	Click here	Click here	Click here	Click here
LMV342-N	Click here	Click here	Click here	Click here	Click here
LMV344-N	Click here	Click here	Click here	Click here	Click here

11.4 Receiving Notification of Documentation Updates

To receive notification of documentation updates, navigate to the device product folder on ti.com. In the upper right corner, click on *Alert me* to register and receive a weekly digest of any product information that has changed. For change details, review the revision history included in any revised document.

11.5 Community Resources

The following links connect to TI community resources. Linked contents are provided "AS IS" by the respective contributors. They do not constitute TI specifications and do not necessarily reflect TI's views; see TI's [Terms of Use](#).

TI E2E™ Online Community *TI's Engineer-to-Engineer (E2E) Community*. Created to foster collaboration among engineers. At e2e.ti.com, you can ask questions, share knowledge, explore ideas and help solve problems with fellow engineers.

Design Support *TI's Design Support* Quickly find helpful E2E forums along with design support tools and contact information for technical support.

11.6 Trademarks

E2E is a trademark of Texas Instruments.

All other trademarks are the property of their respective owners.

11.7 Electrostatic Discharge Caution



These devices have limited built-in ESD protection. The leads should be shorted together or the device placed in conductive foam during storage or handling to prevent electrostatic damage to the MOS gates.

11.8 Glossary

[SLYZ022](#) — *TI Glossary*.

This glossary lists and explains terms, acronyms, and definitions.

12 Mechanical, Packaging, and Orderable Information

The following pages include mechanical, packaging, and orderable information. This information is the most current data available for the designated devices. This data is subject to change without notice and revision of this document. For browser-based versions of this data sheet, refer to the left-hand navigation.

PACKAGING INFORMATION

Orderable Device	Status (1)	Package Type	Package Drawing	Pins	Package Qty	Eco Plan (2)	Lead finish/ Ball material (6)	MSL Peak Temp (3)	Op Temp (°C)	Device Marking (4/5)	Samples
LMV341MG/NOPB	ACTIVE	SC70	DCK	6	1000	RoHS & Green	SN	Level-1-260C-UNLIM	-40 to 125	A78	Samples
LMV341MGX/NOPB	ACTIVE	SC70	DCK	6	3000	RoHS & Green	SN	Level-1-260C-UNLIM	-40 to 125	A78	Samples
LMV342MA/NOPB	ACTIVE	SOIC	D	8	95	RoHS & Green	SN	Level-1-260C-UNLIM	-40 to 125	LMV34 2MA	Samples
LMV342MAX/NOPB	ACTIVE	SOIC	D	8	2500	RoHS & Green	SN	Level-1-260C-UNLIM	-40 to 125	LMV34 2MA	Samples
LMV342MM/NOPB	ACTIVE	VSSOP	DGK	8	1000	RoHS & Green	SN	Level-1-260C-UNLIM	-40 to 125	A82A	Samples
LMV342MMX/NOPB	ACTIVE	VSSOP	DGK	8	3500	RoHS & Green	SN	Level-1-260C-UNLIM	-40 to 125	A82A	Samples
LMV344MA/NOPB	ACTIVE	SOIC	D	14	55	RoHS & Green	SN	Level-1-260C-UNLIM	-40 to 125	LMV344MA	Samples
LMV344MAX/NOPB	ACTIVE	SOIC	D	14	2500	RoHS & Green	SN	Level-1-260C-UNLIM	-40 to 125	LMV344MA	Samples
LMV344MT/NOPB	ACTIVE	TSSOP	PW	14	94	RoHS & Green	NIPDAU SN	Level-1-260C-UNLIM	-40 to 125	LMV34 4MT	Samples
LMV344MTX/NOPB	ACTIVE	TSSOP	PW	14	2500	RoHS & Green	NIPDAU SN	Level-1-260C-UNLIM	-40 to 125	LMV34 4MT	Samples

(1) The marketing status values are defined as follows:

ACTIVE: Product device recommended for new designs.

LIFEBUY: TI has announced that the device will be discontinued, and a lifetime-buy period is in effect.

NRND: Not recommended for new designs. Device is in production to support existing customers, but TI does not recommend using this part in a new design.

PREVIEW: Device has been announced but is not in production. Samples may or may not be available.

OBSELETE: TI has discontinued the production of the device.

(2) **RoHS:** TI defines "RoHS" to mean semiconductor products that are compliant with the current EU RoHS requirements for all 10 RoHS substances, including the requirement that RoHS substance do not exceed 0.1% by weight in homogeneous materials. Where designed to be soldered at high temperatures, "RoHS" products are suitable for use in specified lead-free processes. TI may reference these types of products as "Pb-Free".

RoHS Exempt: TI defines "RoHS Exempt" to mean products that contain lead but are compliant with EU RoHS pursuant to a specific EU RoHS exemption.

Green: TI defines "Green" to mean the content of Chlorine (Cl) and Bromine (Br) based flame retardants meet JS709B low halogen requirements of <=1000ppm threshold. Antimony trioxide based flame retardants must also meet the <=1000ppm threshold requirement.

(3) MSL, Peak Temp. - The Moisture Sensitivity Level rating according to the JEDEC industry standard classifications, and peak solder temperature.

(4) There may be additional marking, which relates to the logo, the lot trace code information, or the environmental category on the device.

(5) Multiple Device Markings will be inside parentheses. Only one Device Marking contained in parentheses and separated by a "~" will appear on a device. If a line is indented then it is a continuation of the previous line and the two combined represent the entire Device Marking for that device.

(6) Lead finish/Ball material - Orderable Devices may have multiple material finish options. Finish options are separated by a vertical ruled line. Lead finish/Ball material values may wrap to two lines if the finish value exceeds the maximum column width.

Important Information and Disclaimer:The information provided on this page represents TI's knowledge and belief as of the date that it is provided. TI bases its knowledge and belief on information provided by third parties, and makes no representation or warranty as to the accuracy of such information. Efforts are underway to better integrate information from third parties. TI has taken and continues to take reasonable steps to provide representative and accurate information but may not have conducted destructive testing or chemical analysis on incoming materials and chemicals. TI and TI suppliers consider certain information to be proprietary, and thus CAS numbers and other limited information may not be available for release.

In no event shall TI's liability arising out of such information exceed the total purchase price of the TI part(s) at issue in this document sold by TI to Customer on an annual basis.

OTHER QUALIFIED VERSIONS OF LMV341-N, LMV344-N :

- Automotive: [LMV341-Q1](#), [LMV344-Q1](#)

NOTE: Qualified Version Definitions:

- Automotive - Q100 devices qualified for high-reliability automotive applications targeting zero defects

TAPE AND REEL INFORMATION

QUADRANT ASSIGNMENTS FOR PIN 1 ORIENTATION IN TAPE

*All dimensions are nominal

Device	Package Type	Package Drawing	Pins	SPQ	Reel Diameter (mm)	Reel Width W1 (mm)	A0 (mm)	B0 (mm)	K0 (mm)	P1 (mm)	W (mm)	Pin1 Quadrant
LMV341MG/NOPB	SC70	DCK	6	1000	178.0	8.4	2.25	2.45	1.2	4.0	8.0	Q3
LMV341MGX/NOPB	SC70	DCK	6	3000	178.0	8.4	2.25	2.45	1.2	4.0	8.0	Q3
LMV342MAX/NOPB	SOIC	D	8	2500	330.0	12.4	6.5	5.4	2.0	8.0	12.0	Q1
LMV342MM/NOPB	VSSOP	DGK	8	1000	178.0	12.4	5.3	3.4	1.4	8.0	12.0	Q1
LMV342MMX/NOPB	VSSOP	DGK	8	3500	330.0	12.4	5.3	3.4	1.4	8.0	12.0	Q1
LMV344MAX/NOPB	SOIC	D	14	2500	330.0	16.4	6.5	9.35	2.3	8.0	16.0	Q1
LMV344MTX/NOPB	TSSOP	PW	14	2500	330.0	12.4	6.95	5.6	1.6	8.0	12.0	Q1

TAPE AND REEL BOX DIMENSIONS

*All dimensions are nominal

Device	Package Type	Package Drawing	Pins	SPQ	Length (mm)	Width (mm)	Height (mm)
LMV341MG/NOPB	SC70	DCK	6	1000	208.0	191.0	35.0
LMV341MGX/NOPB	SC70	DCK	6	3000	208.0	191.0	35.0
LMV342MAX/NOPB	SOIC	D	8	2500	367.0	367.0	35.0
LMV342MM/NOPB	VSSOP	DGK	8	1000	208.0	191.0	35.0
LMV342MMX/NOPB	VSSOP	DGK	8	3500	367.0	367.0	35.0
LMV344MAX/NOPB	SOIC	D	14	2500	356.0	356.0	35.0
LMV344MTX/NOPB	TSSOP	PW	14	2500	367.0	367.0	35.0

TUBE

*All dimensions are nominal

Device	Package Name	Package Type	Pins	SPQ	L (mm)	W (mm)	T (μm)	B (mm)
LMV342MA/NOPB	D	SOIC	8	95	495	8	4064	3.05
LMV344MA/NOPB	D	SOIC	14	55	495	8	4064	3.05
LMV344MT/NOPB	PW	TSSOP	14	94	530	10.2	3600	3.5
LMV344MT/NOPB	PW	TSSOP	14	94	495	8	2514.6	4.06

DCK (R-PDSO-G6)

PLASTIC SMALL-OUTLINE PACKAGE



- NOTES:
- A. All linear dimensions are in millimeters.
 - B. This drawing is subject to change without notice.
 - C. Body dimensions do not include mold flash or protrusion. Mold flash and protrusion shall not exceed 0.15 per side.
 - D. Falls within JEDEC MO-203 variation AB.

DCK (R-PDSO-G6)

PLASTIC SMALL OUTLINE

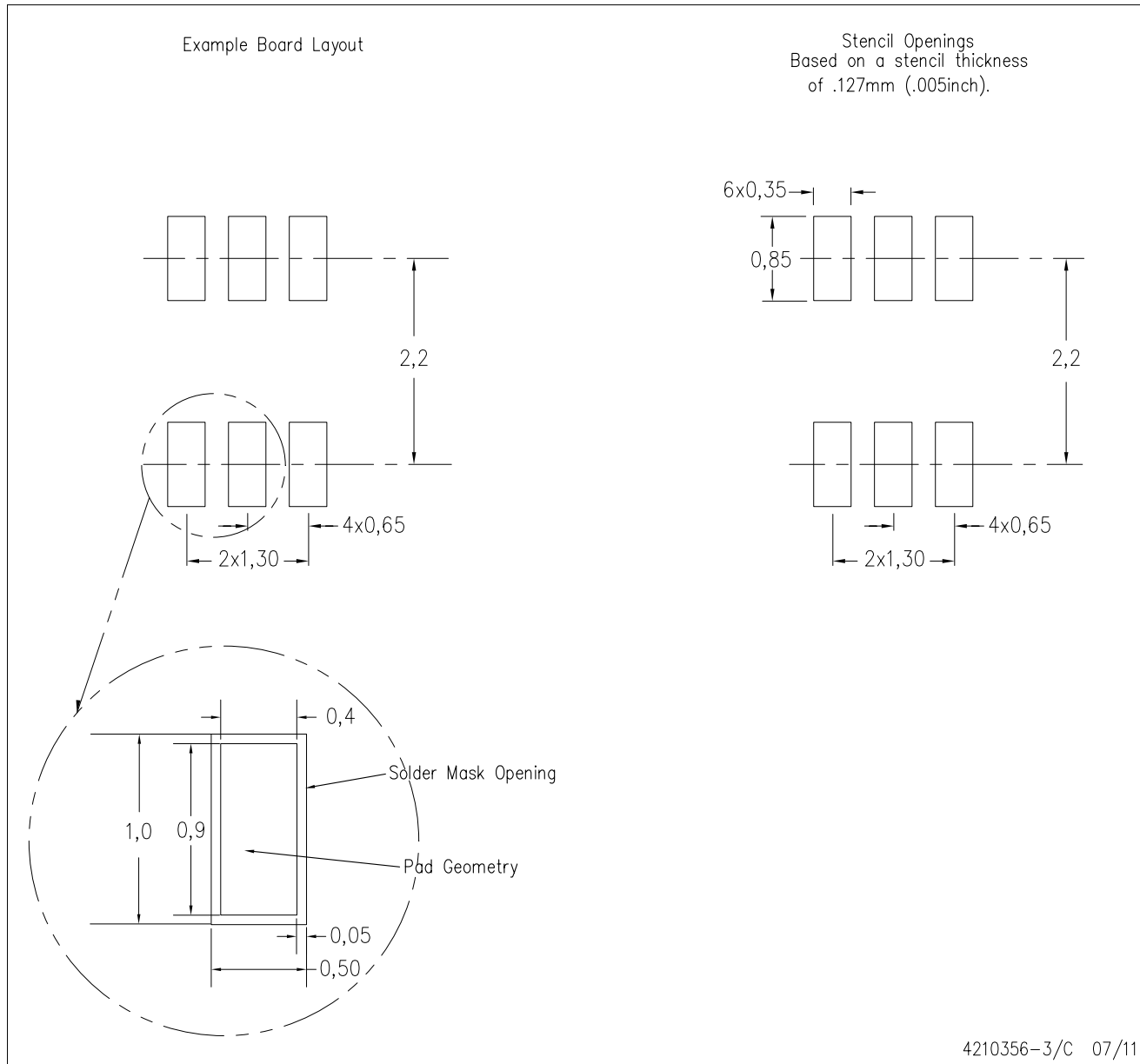

- NOTES:
- All linear dimensions are in millimeters.
 - This drawing is subject to change without notice.
 - Customers should place a note on the circuit board fabrication drawing not to alter the center solder mask defined pad.
 - Publication IPC-7351 is recommended for alternate designs.
 - Laser cutting apertures with trapezoidal walls and also rounding corners will offer better paste release. Customers should contact their board assembly site for stencil design recommendations. Example stencil design based on a 50% volumetric metal load solder paste. Refer to IPC-7525 for other stencil recommendations.

D (R-PDSO-G14)

PLASTIC SMALL OUTLINE



- NOTES:
- All linear dimensions are in millimeters.
 - This drawing is subject to change without notice.
 - Publication IPC-7351 is recommended for alternate designs.
 - Laser cutting apertures with trapezoidal walls and also rounding corners will offer better paste release. Customers should contact their board assembly site for stencil design recommendations. Refer to IPC-7525 for other stencil recommendations.
 - Customers should contact their board fabrication site for solder mask tolerances between and around signal pads.

PW (R-PDSO-G14)

PLASTIC SMALL OUTLINE



- NOTES:
- All linear dimensions are in millimeters.
 - This drawing is subject to change without notice.
 - Publication IPC-7351 is recommended for alternate designs.
 - Laser cutting apertures with trapezoidal walls and also rounding corners will offer better paste release. Customers should contact their board assembly site for stencil design recommendations. Refer to IPC-7525 for other stencil recommendations.
 - Customers should contact their board fabrication site for solder mask tolerances between and around signal pads.



D0008A

PACKAGE OUTLINE

SOIC - 1.75 mm max height

SMALL OUTLINE INTEGRATED CIRCUIT



NOTES:

1. Linear dimensions are in inches [millimeters]. Dimensions in parenthesis are for reference only. Controlling dimensions are in inches. Dimensioning and tolerancing per ASME Y14.5M.
2. This drawing is subject to change without notice.
3. This dimension does not include mold flash, protrusions, or gate burrs. Mold flash, protrusions, or gate burrs shall not exceed .006 [0.15] per side.
4. This dimension does not include interlead flash.
5. Reference JEDEC registration MS-012, variation AA.

EXAMPLE BOARD LAYOUT

D0008A

SOIC - 1.75 mm max height

SMALL OUTLINE INTEGRATED CIRCUIT



LAND PATTERN EXAMPLE
EXPOSED METAL SHOWN
SCALE:8X



SOLDER MASK DETAILS

4214825/C 02/2019

NOTES: (continued)

- 6. Publication IPC-7351 may have alternate designs.
- 7. Solder mask tolerances between and around signal pads can vary based on board fabrication site.

EXAMPLE STENCIL DESIGN

D0008A

SOIC - 1.75 mm max height

SMALL OUTLINE INTEGRATED CIRCUIT



SOLDER PASTE EXAMPLE
BASED ON .005 INCH [0.125 MM] THICK STENCIL
SCALE:8X

4214825/C 02/2019

NOTES: (continued)

8. Laser cutting apertures with trapezoidal walls and rounded corners may offer better paste release. IPC-7525 may have alternate design recommendations.
9. Board assembly site may have different recommendations for stencil design.



- NOTES:
- A. All linear dimensions are in millimeters.
 - B. This drawing is subject to change without notice.
 - C. Publication IPC-7351 is recommended for alternate designs.
 - D. Laser cutting apertures with trapezoidal walls and also rounding corners will offer better paste release. Customers should contact their board assembly site for stencil design recommendations. Refer to IPC-7525 for other stencil recommendations.
 - E. Customers should contact their board fabrication site for solder mask tolerances between and around signal pads.

IMPORTANT NOTICE AND DISCLAIMER

TI PROVIDES TECHNICAL AND RELIABILITY DATA (INCLUDING DATA SHEETS), DESIGN RESOURCES (INCLUDING REFERENCE DESIGNS), APPLICATION OR OTHER DESIGN ADVICE, WEB TOOLS, SAFETY INFORMATION, AND OTHER RESOURCES "AS IS" AND WITH ALL FAULTS, AND DISCLAIMS ALL WARRANTIES, EXPRESS AND IMPLIED, INCLUDING WITHOUT LIMITATION ANY IMPLIED WARRANTIES OF MERCHANTABILITY, FITNESS FOR A PARTICULAR PURPOSE OR NON-INFRINGEMENT OF THIRD PARTY INTELLECTUAL PROPERTY RIGHTS.

These resources are intended for skilled developers designing with TI products. You are solely responsible for (1) selecting the appropriate TI products for your application, (2) designing, validating and testing your application, and (3) ensuring your application meets applicable standards, and any other safety, security, regulatory or other requirements.

These resources are subject to change without notice. TI grants you permission to use these resources only for development of an application that uses the TI products described in the resource. Other reproduction and display of these resources is prohibited. No license is granted to any other TI intellectual property right or to any third party intellectual property right. TI disclaims responsibility for, and you will fully indemnify TI and its representatives against, any claims, damages, costs, losses, and liabilities arising out of your use of these resources.

TI's products are provided subject to [TI's Terms of Sale](#) or other applicable terms available either on ti.com or provided in conjunction with such TI products. TI's provision of these resources does not expand or otherwise alter TI's applicable warranties or warranty disclaimers for TI products.

TI objects to and rejects any additional or different terms you may have proposed.

Mailing Address: Texas Instruments, Post Office Box 655303, Dallas, Texas 75265
Copyright © 2022, Texas Instruments Incorporated