

MCP629x 10MHz 轨至轨运算放大器

1 特性

- 增益带宽积产品：典型值 10MHz
- 工作电源电压范围：2.4V 至 5.5V
- 轨至轨输入/输出
- 低输入偏置电流：1pA
- 低静态电流：0.6mA
- 输入电压噪声：8.7nV/√Hz (f = 10kHz 时)
- 内部射频和 EMI 滤波器
- 工作温度范围：-40°C 至 125°C
- 单位增益稳定
- 由于具有电阻式开环输出阻抗，因此可在更高的容性负载下更轻松地实现稳定

2 应用

- 电源模块
- 烟雾探测器
- HVAC：暖通空调
- 电池供电 应用
- 传感器信号调节
- 光电二极管放大器
- 模拟滤波器
- 医疗仪器
- 笔记本电脑和 PDA
- 条形码扫描仪
- 音频接收器
- 汽车信息娱乐系统

3 说明

MCP6291（单通道）、MCP6292（双通道）和 MCP6294（四通道）器件组成了一个通用低功耗运算放大器系列。具有轨至轨输入和输出摆幅、低静态电流（每通道的典型值为 600μA）、10MHz 的较宽带宽和低噪声（10kHz 时为 8.7nV/√Hz）等特性，因此对于需要在成本与性能间实现良好平衡的各类应用需求，本系列器件非常有吸引力。其低输入偏置电流使该系列器件适用于带有高源阻抗的应用。

MCP629x 采用稳健耐用的设计，方便电路设计人员使用。该器件具有单位增益稳定的集成 RFI 和 EMI 抑制滤波器，在过驱条件下不会出现反相并且具有高静电放电 (ESD) 保护（4kV 人体模型 (HBM)）。

MCP629x 系列的工作温度范围为 -40°C 至 125°C。该系列器件的电源电压范围为 2.4V 至 5.5V。

器件信息⁽¹⁾

器件型号	封装	封装尺寸 (标称值)
MCP6291	SOT-23 (5)	1.60mm × 2.90mm
	SC70 (5)	1.25mm × 2.00mm
MCP6292	SOIC (8)	3.91mm × 4.90mm
	VSSOP (8)	3.00mm × 3.00mm
	SOT-23 (8)	1.60mm × 2.90mm
MCP6294	SOIC (14)	8.65mm × 3.91mm
	TSSOP (14)	4.40mm × 5.00mm

(1) 如需了解所有可用封装，请参阅数据表末尾的可订购产品附录。

低侧电机控制

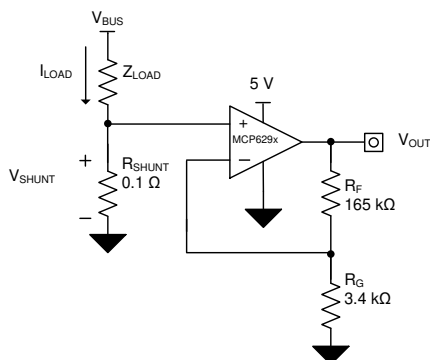

小信号过冲与负载电容间的关系

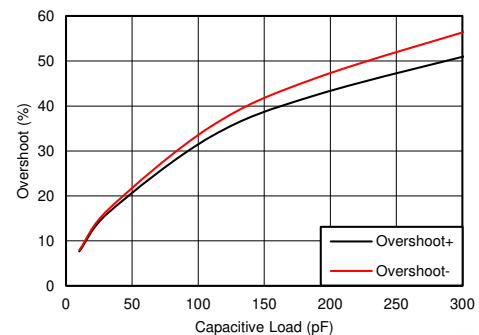

目录

1	特性	1	8.3	Feature Description	19
2	应用	1	8.4	Device Functional Modes	19
3	说明	1	9	Application and Implementation	20
4	修订历史记录	2	9.1	Application Information	20
5	Device Comparison Table	4	9.2	Typical Application	20
6	Pin Configuration and Functions	5	10	Power Supply Recommendations	22
7	Specifications	8	10.1	Input and ESD Protection	22
7.1	Absolute Maximum Ratings	8	11	Layout	23
7.2	ESD Ratings	8	11.1	Layout Guidelines	23
7.3	Recommended Operating Conditions	8	11.2	Layout Example	23
7.4	Thermal Information: MCP6291	8	12	器件和文档支持	24
7.5	Thermal Information: MCP6292	9	12.1	文档支持	24
7.6	Thermal Information: MCP6294	9	12.2	相关链接	24
7.7	Electrical Characteristics: V_S (Total Supply Voltage) = (V+) – (V-) = 2.4 V to 5.5 V	10	12.3	接收文档更新通知	24
7.8	Typical Characteristics	12	12.4	社区资源	24
8	Detailed Description	18	12.5	商标	24
8.1	Overview	18	12.6	静电放电警告	24
8.2	Functional Block Diagram	18	12.7	Glossary	24
			13	机械、封装和可订购信息	24

4 修订历史记录

Changes from Revision C (January 2019) to Revision D Page

- 已添加 向数据表添加了 SOT-23 (8) (DDF) 封装

Changes from Revision B (April 2018) to Revision C Page

- 已删除 从器件信息 表中删除了 SOT-23 封装预览符号
- 已添加 向器件信息 表添加了 SC70 封装
- Added DCK package information to *Device Comparison Table*
- Deleted DBV package preview notation from *Pin Configuration and Functions* section
- Added DCK package drawing and pin functions to *Pin Configuration and Functions* section
- Added DBV (SOT-23) and DCK (SC70) thermal information

Changes from Revision A (October 2017) to Revision B Page

- Added DGK package to *Thermal Information* table

Changes from Original (July 2017) to Revision A Page

- 已删除 删除了器件信息 表中的 MCP6291 SC70、SOT-553 和 SOIC 封装
- 已删除 删除了器件信息 表中的 MCP6292 WSON 和 VSSOP (10) 封装
- 已更改 将器件信息 表中的 MCP6294 14 引脚 SOIC 封装从预览更改为生产数据
- Deleted DCK, DRL, DSG, RTE and 8-pin D packages from *Device Comparison* table
- Deleted DRL (SOT-533) package from MCP6291 pinout image and table in *Pin Configuration and Functions* section
- Deleted MCP6291 DCK (SC70) and D (SOIC) package pinout drawings and pin information from *Pin Configuration and Functions* section
- Deleted MCP6292 DSG (WSON) and DGS (VSSOP) package pinout drawings and pin table information in *Pin Configuration and Functions* section

-
- Deleted package preview note from MCP6294 pinout drawing in *Pin Configuration and Functions* section 7
 - Added MCP6294 *Thermal Information* table 9
-

5 Device Comparison Table

DEVICE	NO. OF CHANNELS	PACKAGE LEADS					
		DBV	DCK	D	DGK	PW	DDF
MCP6291	1	5	5	—	—	—	—
MCP6292	2	—	—	8	8	—	8
MCP6294	4	—	—	14	—	14	—

6 Pin Configuration and Functions

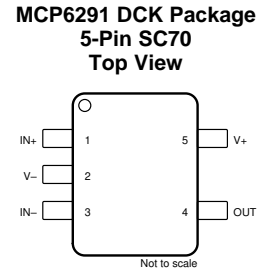
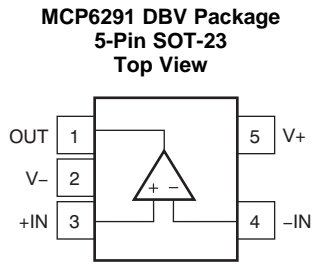

Pin Functions: MCP6921

NAME	PIN		I/O	DESCRIPTION
	NO.			
	SOT-23 (DBV)	SC70 (DCK)		
-IN	4	3	I	Inverting input
+IN	3	1	I	Noninverting input
OUT	1	4	O	Output
V-	2	8	—	Negative (lowest) supply or ground (for single-supply operation)
V+	5	5	—	Positive (highest) supply

**MCP6292 D, DGK, DDF Packages
8-Pin SOIC, VSSOP
Top View**

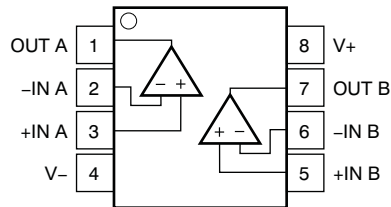

Pin Functions: MCP6292

PIN		I/O	DESCRIPTION
NAME	NO.		
-IN A	2	I	Inverting input, channel A
+IN A	3	I	Noninverting input, channel A
-IN B	6	I	Inverting input, channel B
+IN B	5	I	Noninverting input, channel B
OUT A	1	O	Output, channel A
OUT B	7	O	Output, channel B
V-	4	—	Negative (lowest) supply or ground (for single-supply operation)
V+	8	—	Positive (highest) supply

**MCP6294 D, PW Packages
14-Pin SOIC, TSSOP
Top View**

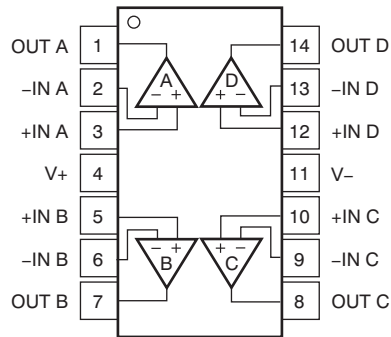

Pin Functions: MCP6294

PIN		I/O	DESCRIPTION
NAME	NO.		
-IN A	2	I	Inverting input, channel A
+IN A	3	I	Noninverting input, channel A
-IN B	6	I	Inverting input, channel B
+IN B	5	I	Noninverting input, channel B
-IN C	9	I	Inverting input, channel C
+IN C	10	I	Noninverting input, channel C
-IN D	13	I	Inverting input, channel D
+IN D	12	I	Noninverting input, channel D
OUT A	1	O	Output, channel A
OUT B	7	O	Output, channel B
OUT C	8	O	Output, channel C
OUT D	14	O	Output, channel D
V-	11	—	Negative (lowest) supply or ground (for single-supply operation)
V+	4	—	Positive (highest) supply

7 Specifications

7.1 Absolute Maximum Ratings

over operating free-air temperature (unless otherwise noted)⁽¹⁾

			MIN	MAX	UNIT
Supply voltage				6	V
Signal input pins	Voltage ⁽²⁾	Common-mode	(V ₋) – 0.5	(V ₊) + 0.5	V
		Differential	(V ₊) – (V ₋) + 0.2		
	Current ⁽²⁾		–10	10	mA
Output short-circuit ⁽³⁾			Continuous		mA
Specified, T _A			–40	125	°C
Junction, T _J				150	°C
Storage, T _{stg}			–65	150	°C

- (1) Stresses beyond those listed under *Absolute Maximum Ratings* may cause permanent damage to the device. These are stress ratings only, and functional operation of the device at these or any other conditions beyond those indicated under *Recommended Operating Conditions* is not implied. Exposure to absolute-maximum-rated conditions for extended periods may affect device reliability.
- (2) Input pins are diode-clamped to the power-supply rails. Current limit input signals that can swing more than 0.5 V beyond the supply rails to 10 mA or less.
- (3) Short-circuit to ground, one amplifier per package.

7.2 ESD Ratings

over operating free-air temperature range (unless otherwise noted)

			VALUE	UNIT
V _(ESD)	Electrostatic discharge	Human-body model (HBM), per ANSI/ESDA/JEDEC JS-001 ⁽¹⁾	±4000	V
		Charged-device model (CDM), per JEDEC specification JESD22-C101 ⁽²⁾	±1500	

- (1) JEDEC document JEP155 states that 500-V HBM allows safe manufacturing with a standard ESD control process.
- (2) JEDEC document JEP157 states that 250-V CDM allows safe manufacturing with a standard ESD control process.

7.3 Recommended Operating Conditions

over operating free-air temperature range (unless otherwise noted)

			MIN	MAX	UNIT
V _S	Supply voltage		2.4	5.5	V
	Specified temperature		–40	125	°C

7.4 Thermal Information: MCP6291

THERMAL METRIC ⁽¹⁾		MCP6291		UNIT
		DBV (SOT-23)	DCK (SC70)	
		5 PINS	5 PINS	
R _{θJA}	Junction-to-ambient thermal resistance	221.7	263.3	°C/W
R _{θJC(top)}	Junction-to-case(top) thermal resistance	144.7	75.5	°C/W
R _{θJB}	Junction-to-board thermal resistance	49.7	51.0	°C/W
ψ _{JT}	Junction-to-top characterization parameter	26.1	1.0	°C/W
ψ _{JB}	Junction-to-board characterization parameter	49.0	50.3	°C/W

- (1) For more information about traditional and new thermal metrics, see the [Semiconductor and IC Package Thermal Metrics](#) application report.

7.5 Thermal Information: MCP6292

THERMAL METRIC ⁽¹⁾		MCP6292			UNIT
		D (SOIC)	DGK (VSSOP)	DDF (SOT-23)	
		8 PINS	8 PINS	8 PINS	
$R_{\theta JA}$	Junction-to-ambient thermal resistance	157.6	201.2	184.4	°C/W
$R_{\theta JC(top)}$	Junction-to-case (top) thermal resistance	104.6	85.7	112.8	°C/W
$R_{\theta JB}$	Junction-to-board thermal resistance	99.7	122.9	99.9	°C/W
Ψ_{JT}	Junction-to-top characterization parameter	55.6	21.2	18.7	°C/W
Ψ_{JB}	Junction-to-board characterization parameter	99.2	121.4	99.3	°C/W

(1) For more information about traditional and new thermal metrics, see the [Semiconductor and IC Package Thermal Metrics](#) application report.

7.6 Thermal Information: MCP6294

THERMAL METRIC ⁽¹⁾		MCP6294		UNIT
		D (SOIC)	PW (TSSOP)	
		14 PINS	14 PINS	
$R_{\theta JA}$	Junction-to-ambient thermal resistance	106.9	135.8	°C/W
$R_{\theta JC(top)}$	Junction-to-case(top) thermal resistance	64	64	°C/W
$R_{\theta JB}$	Junction-to-board thermal resistance	63	79	°C/W
Ψ_{JT}	Junction-to-top characterization parameter	25.9	15.7	°C/W
Ψ_{JB}	Junction-to-board characterization parameter	62.7	78.4	°C/W

(1) For more information about traditional and new thermal metrics, see the [Semiconductor and IC Package Thermal Metrics](#) application report.

7.7 Electrical Characteristics: V_S (Total Supply Voltage) = $(V_+) - (V_-) = 2.4\text{ V to }5.5\text{ V}$

 at $T_A = 25^\circ\text{C}$, $R_L = 10\text{ k}\Omega$ connected to $V_S / 2$, $V_{CM} = V_S / 2$, and $V_{OUT} = V_S / 2$ (unless otherwise noted)

PARAMETER		TEST CONDITIONS	MIN	TYP	MAX	UNIT
OFFSET VOLTAGE						
V_{OS}	Input offset voltage	$V_S = 5\text{ V}$		± 0.3	± 3	mV
		$V_S = 5\text{ V}$, $T_A = -40^\circ\text{C to }125^\circ\text{C}$			± 5	
dV_{OS}/dT	Drift	$V_S = 5\text{ V}$, $T_A = -40^\circ\text{C to }125^\circ\text{C}$		± 1.1		$\mu\text{V}/^\circ\text{C}$
PSRR	Power-supply rejection ratio	$V_S = 2.4\text{ V} - 5.5\text{ V}$, $V_{CM} = (V_-)$		± 7		$\mu\text{V}/\text{V}$
	Channel separation, DC	At DC		100		dB
INPUT VOLTAGE RANGE						
V_{CM}	Common-mode voltage range	$V_S = 2.4\text{ V to }5.5\text{ V}$	$(V_-) - 0.1$		$(V_+) + 0.1$	V
CMRR	Common-mode rejection ratio	$V_S = 5.5\text{ V}$ $(V_-) - 0.1\text{ V} < V_{CM} < (V_+) - 1.4\text{ V}$ $T_A = -40^\circ\text{C to }125^\circ\text{C}$	80	103		dB
		$V_S = 5.5\text{ V}$ $V_{CM} = -0.1\text{ V to }5.6\text{ V}$ $T_A = -40^\circ\text{C to }125^\circ\text{C}$	57	87		
		$V_S = 2.4\text{ V}$ $(V_-) - 0.1\text{ V} < V_{CM} < (V_+) - 1.4\text{ V}$ $T_A = -40^\circ\text{C to }125^\circ\text{C}$		88		
		$V_S = 2.4\text{ V}$ $V_{CM} = -0.1\text{ V to }1.9\text{ V}$ $T_A = -40^\circ\text{C to }125^\circ\text{C}$		81		
INPUT BIAS CURRENT						
I_B	Input bias current			± 1		pA
I_{OS}	Input offset current			± 0.05		pA
NOISE						
E_n	Input voltage noise (peak-to-peak)	$V_S = 5\text{ V}$, $f = 0.1\text{ Hz to }10\text{ Hz}$		4.77		μV_{PP}
e_n	Input voltage noise density	$V_S = 5\text{ V}$, $f = 10\text{ kHz}$, $R_L = 10\text{ k}\Omega$		8.7		$\text{nV}/\sqrt{\text{Hz}}$
		$V_S = 5\text{ V}$, $f = 1\text{ kHz}$, $R_L = 10\text{ k}\Omega$		16		
i_n	Input current noise density	$f = 1\text{ kHz}$		10		$\text{fA}/\sqrt{\text{Hz}}$
INPUT CAPACITANCE						
C_{ID}	Differential			2		pF
C_{IC}	Common-mode			4		pF
OPEN-LOOP GAIN						
A_{OL}	Open-loop voltage gain	$V_S = 2.4\text{ V}$ $(V_-) + 0.04\text{ V} < V_O < (V_+) - 0.04\text{ V}$ $R_L = 10\text{ k}\Omega$		100		dB
		$V_S = 5.5\text{ V}$ $(V_-) + 0.05\text{ V} < V_O < (V_+) - 0.05\text{ V}$ $R_L = 10\text{ k}\Omega$	104	130		
		$V_S = 2.4\text{ V}$ $(V_-) + 0.06\text{ V} < V_O < (V_+) - 0.06\text{ V}$ $R_L = 2\text{ k}\Omega$		100		
		$V_S = 5.5\text{ V}$ $(V_-) + 0.15\text{ V} < V_O < (V_+) - 0.15\text{ V}$ $R_L = 2\text{ k}\Omega$		130		
FREQUENCY RESPONSE						
GBP	Gain bandwidth product	$V_S = 5\text{ V}$, $G = 1$		10		MHz
ϕ_m	Phase margin	$V_S = 5\text{ V}$, $G = 1$		55		$^\circ$
SR	Slew rate	$V_S = 5\text{ V}$, $G = 1$		6.5		V/ μs
t_s	Settling time	To 0.1%, $V_S = 5\text{ V}$, 2-V step, $G = 1$ $C_L = 100\text{ pF}$		0.5		μs
		To 0.01%, $V_S = 5\text{ V}$, 2-V step, $G = 1$ $C_L = 100\text{ pF}$		1		
t_{OR}	Overload recovery time	$V_S = 5\text{ V}$ $V_{IN} \times \text{gain} > V_S$		0.2		μs

Electrical Characteristics: V_S (Total Supply Voltage) = (V+) – (V–) = 2.4 V to 5.5 V (continued)

 at $T_A = 25^\circ\text{C}$, $R_L = 10\text{ k}\Omega$ connected to $V_S / 2$, $V_{CM} = V_S / 2$, and $V_{OUT} = V_S / 2$ (unless otherwise noted)

PARAMETER	TEST CONDITIONS	MIN	TYP	MAX	UNIT
THD + N Total harmonic distortion + noise ⁽¹⁾	$V_S = 5\text{ V}$ $V_O = 1\text{ V}_{RMS}$ $G = 1$, $f = 1\text{ kHz}$		0.0008%		
OUTPUT					
V_O Voltage output swing from supply rails	$V_S = 5.5\text{ V}$, $R_L = 10\text{ k}\Omega$			15	mV
	$V_S = 5.5\text{ V}$, $R_L = 2\text{ k}\Omega$			50	
I_{SC} Short-circuit current	$V_S = 5\text{ V}$		± 50		mA
Z_O Open-loop output impedance	$V_S = 5\text{ V}$, $f = 10\text{ MHz}$		100		Ω
POWER SUPPLY					
I_Q Quiescent current per amplifier	$V_S = 5.5\text{ V}$, $I_O = 0\text{ mA}$		600	1300	μA

(1) Third-order filter; bandwidth = 80 kHz at –3 dB.

7.8 Typical Characteristics

at $T_A = 25^\circ\text{C}$, $V_S = 5.5\text{ V}$, $R_L = 10\text{ k}\Omega$ connected to $V_S / 2$, $V_{CM} = V_S / 2$, and $V_{OUT} = V_S / 2$ (unless otherwise noted)



图 1. Offset Voltage vs Temperature



图 2. Offset Voltage vs Common-Mode Voltage

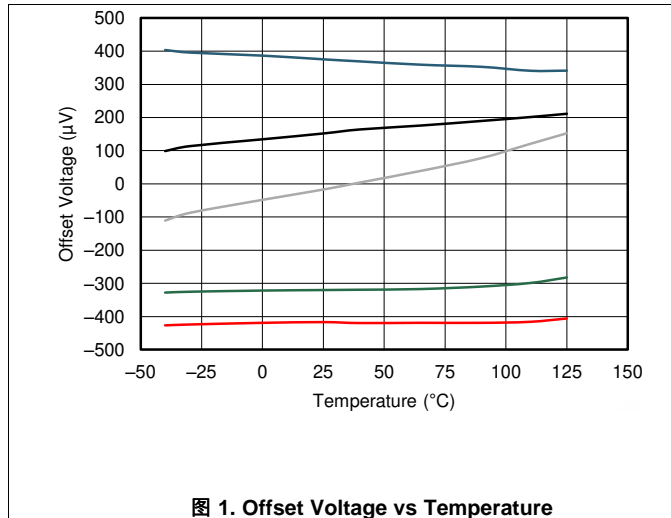

图 3. Offset Voltage vs Power Supply

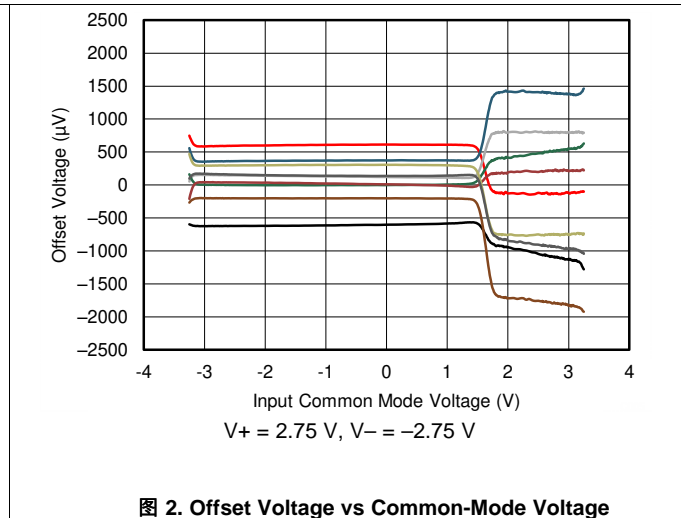

图 4. Open-Loop Gain and Phase vs Frequency

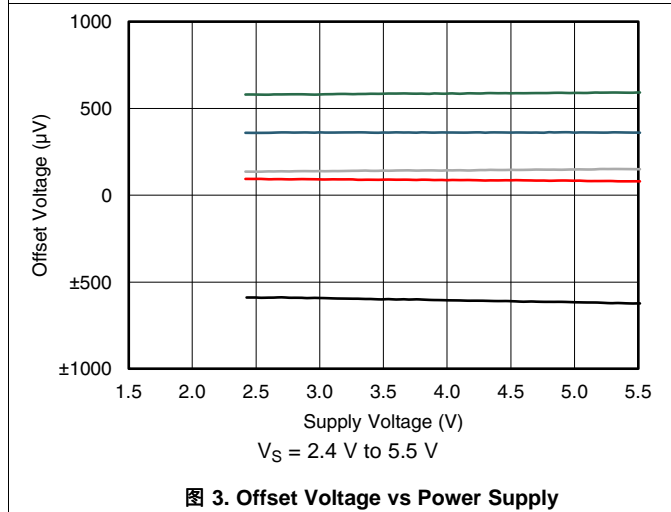

图 5. Closed-Loop Gain vs Frequency

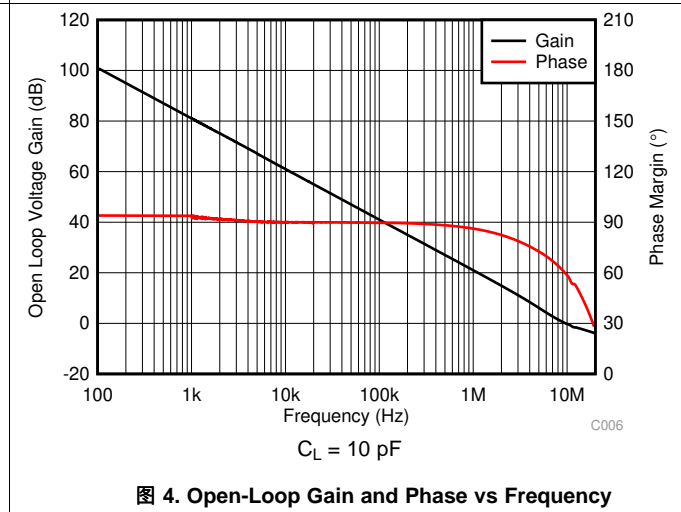

图 6. Input Bias Current vs Temperature

Typical Characteristics (接下页)

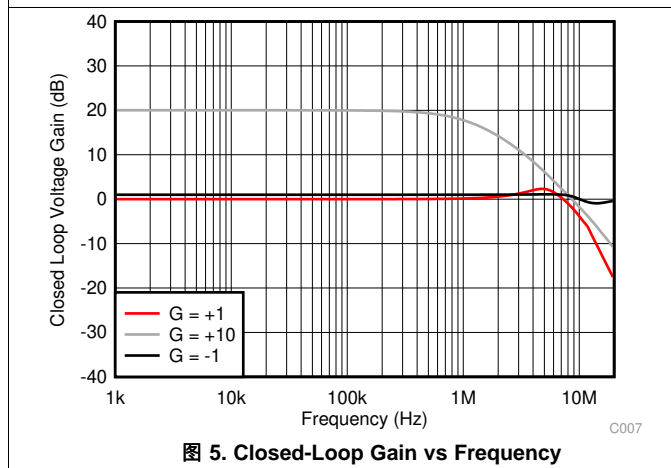
at $T_A = 25^\circ\text{C}$, $V_S = 5.5\text{ V}$, $R_L = 10\text{ k}\Omega$ connected to $V_S / 2$, $V_{CM} = V_S / 2$, and $V_{OUT} = V_S / 2$ (unless otherwise noted)

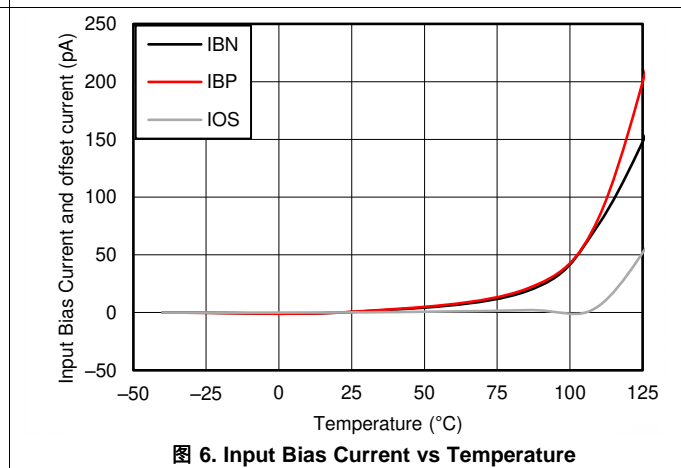

图 7. Output Voltage Swing vs Output Current



图 8. CMRR and PSRR vs Frequency (Referred to Input)

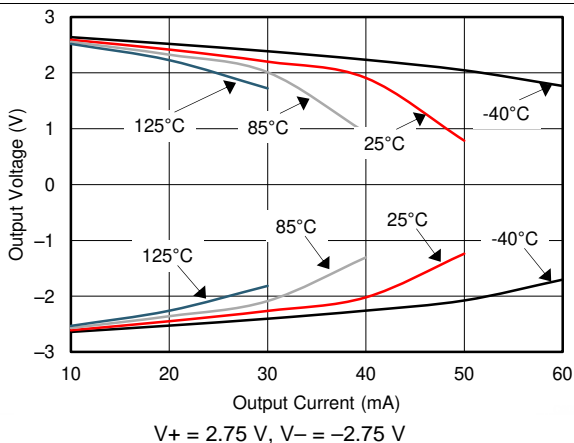

图 9. CMRR vs Temperature

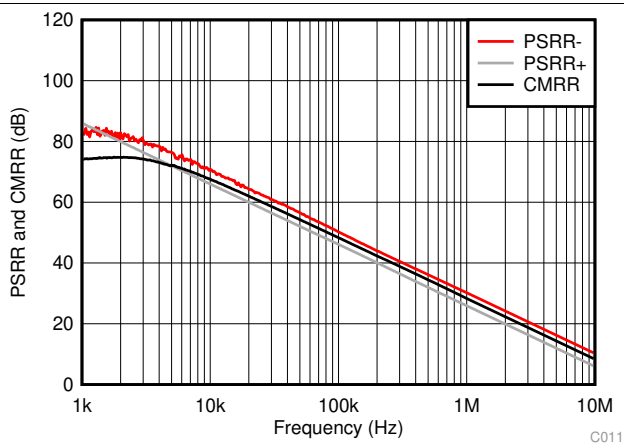

图 10. CMRR vs Temperature

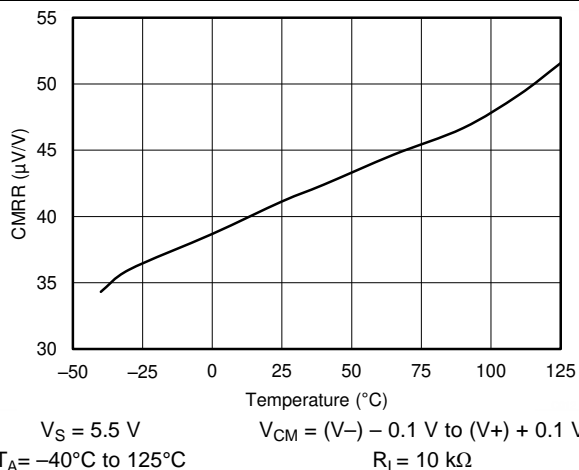

图 11. PSRR vs Temperature

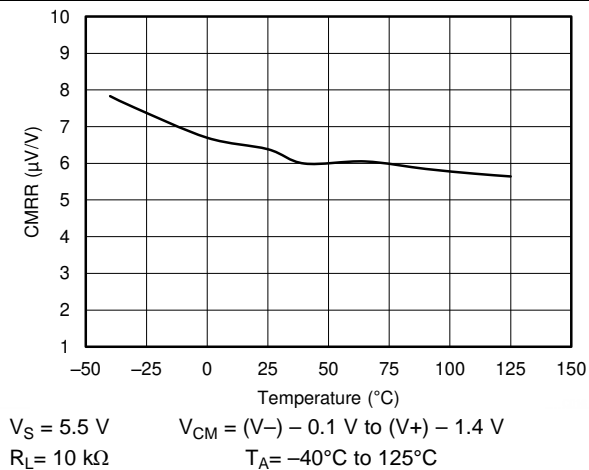

图 12. 0.1-Hz to 10-Hz Input Voltage Noise

Typical Characteristics (接下页)

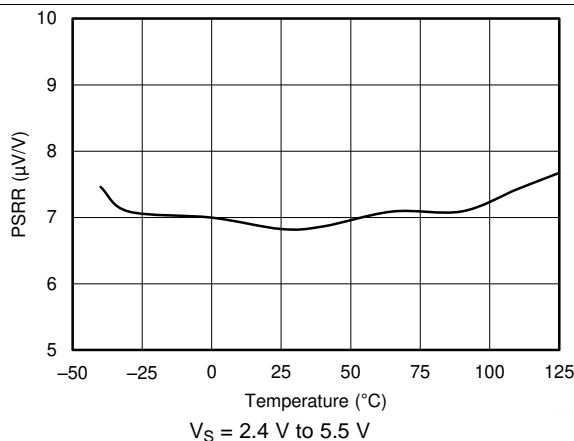
at $T_A = 25^\circ\text{C}$, $V_S = 5.5\text{ V}$, $R_L = 10\text{ k}\Omega$ connected to $V_S / 2$, $V_{CM} = V_S / 2$, and $V_{OUT} = V_S / 2$ (unless otherwise noted)

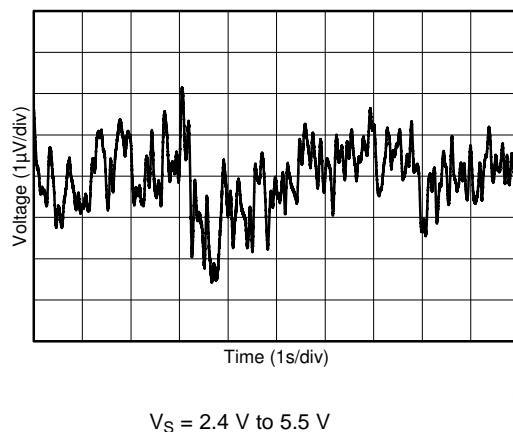
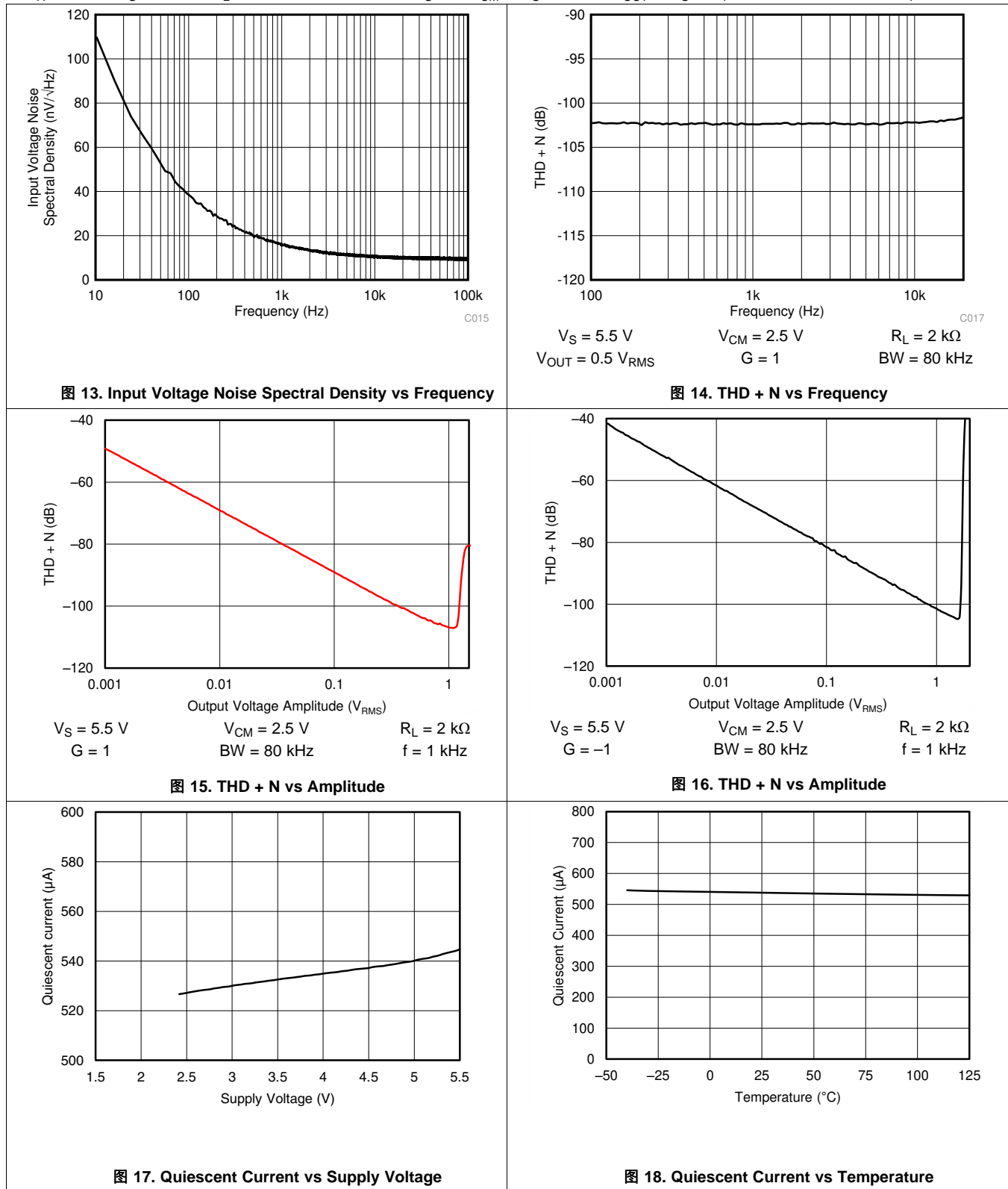

Typical Characteristics (接下页)

at $T_A = 25^\circ\text{C}$, $V_S = 5.5\text{ V}$, $R_L = 10\text{ k}\Omega$ connected to $V_S / 2$, $V_{CM} = V_S / 2$, and $V_{OUT} = V_S / 2$ (unless otherwise noted)



图 19. Open-Loop Output Impedance vs Frequency



$V_+ = 2.75\text{ V}$ $V_- = -2.75\text{ V}$ $G = 1\text{ V/V}$
 $R_L = 10\text{ k}\Omega$ $V_{OUT\text{ step}} = 100\text{ mV}_{p-p}$

图 20. Small-Signal Overshoot vs Load Capacitance

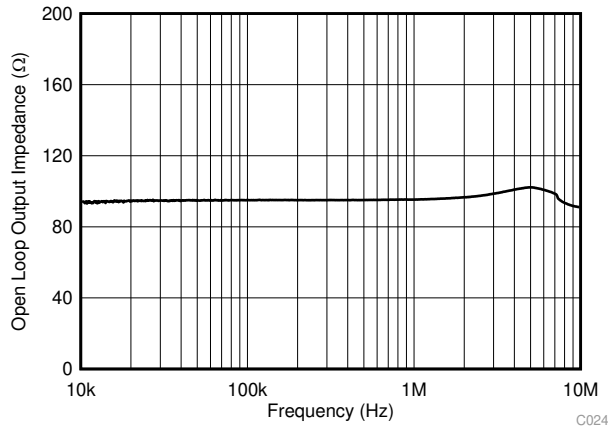
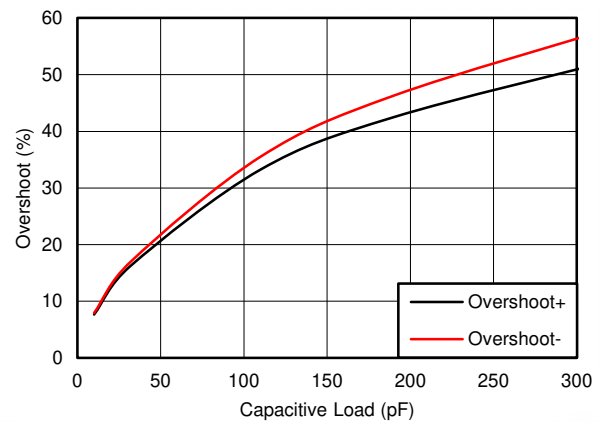
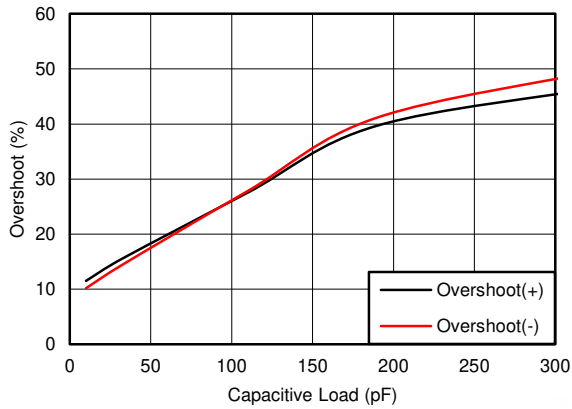

$V_+ = 2.75\text{ V}$ $V_- = -2.75\text{ V}$ $G = -1\text{ V/V}$
 $R_L = 10\text{ k}\Omega$ $V_{OUT\text{ step}} = 100\text{ mV}_{p-p}$

图 21. Small-Signal Overshoot vs Load Capacitance

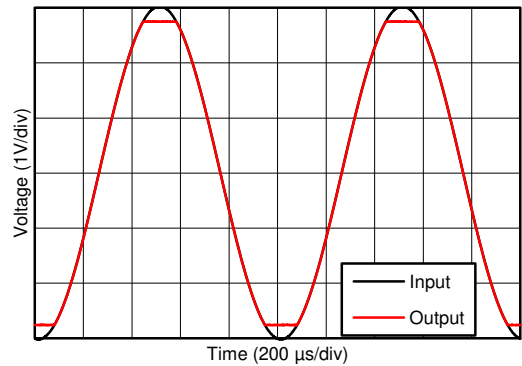

$V_+ = 2.75\text{ V}$, $V_- = -2.75\text{ V}$

图 22. No Phase Reversal

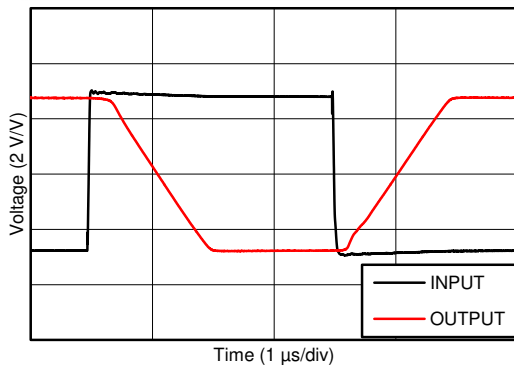

$V_+ = 2.75\text{ V}$ $V_- = -2.75\text{ V}$ $G = -10\text{ V/V}$

图 23. Overload Recovery

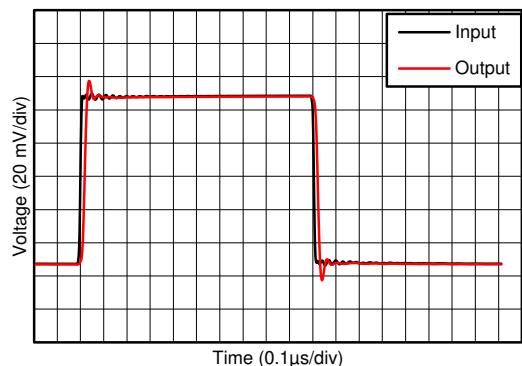

$V_+ = 2.75\text{ V}$ $V_- = -2.75\text{ V}$ $G = 1\text{ V/V}$

图 24. Small-Signal Step Response

Typical Characteristics (接下页)

at $T_A = 25^\circ\text{C}$, $V_S = 5.5\text{ V}$, $R_L = 10\text{ k}\Omega$ connected to $V_S / 2$, $V_{CM} = V_S / 2$, and $V_{OUT} = V_S / 2$ (unless otherwise noted)

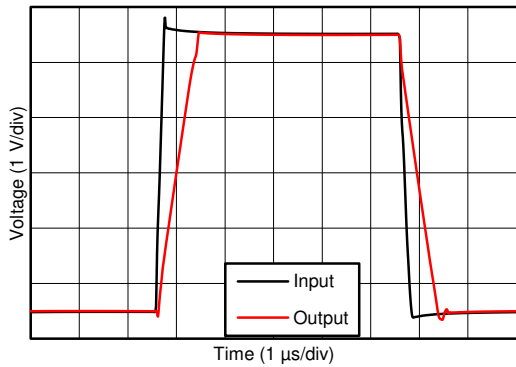

$V_+ = 2.75\text{ V}$ $V_- = -2.75\text{ V}$ $C_L = 100\text{ pF}$
 $G = 1\text{ V/V}$

图 25. Large-Signal Step Response



图 26. Short-Circuit Current vs Temperature



图 27. Electromagnetic Interference Rejection Ratio Referred to Noninverting Input (EMIRR+) vs Frequency

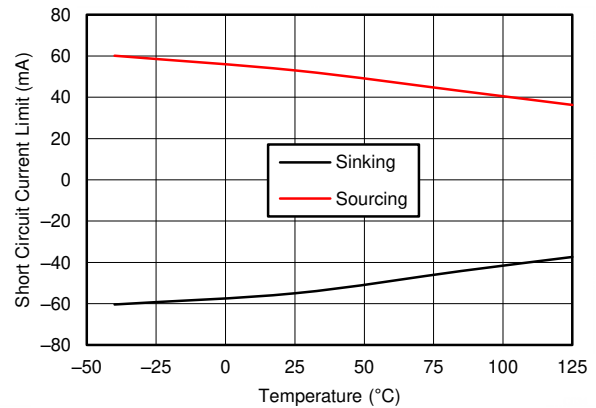

图 28. Channel Separation vs Frequency

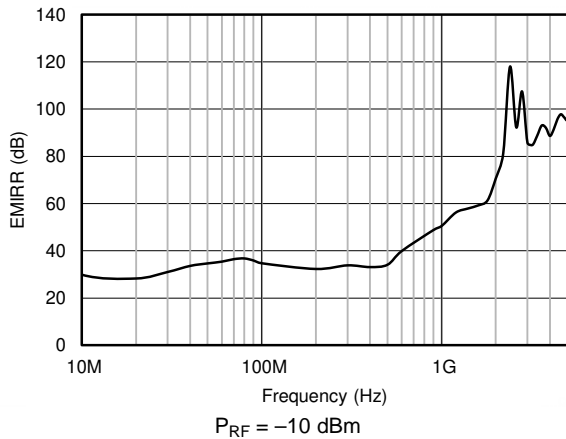

图 29. Phase Margin vs Capacitive Load

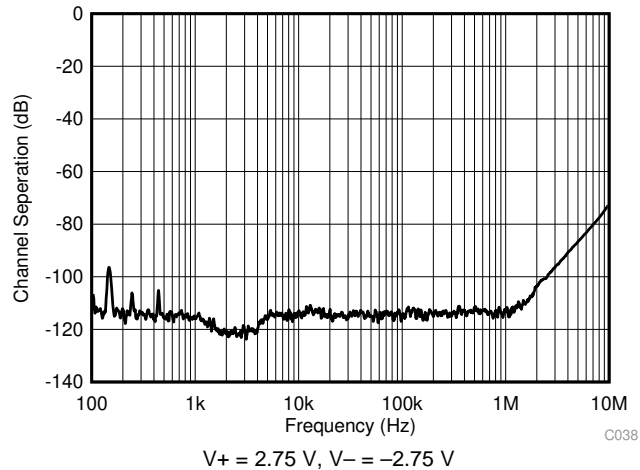

图 30. Open Loop Voltage Gain vs Output Voltage

Typical Characteristics (接下页)

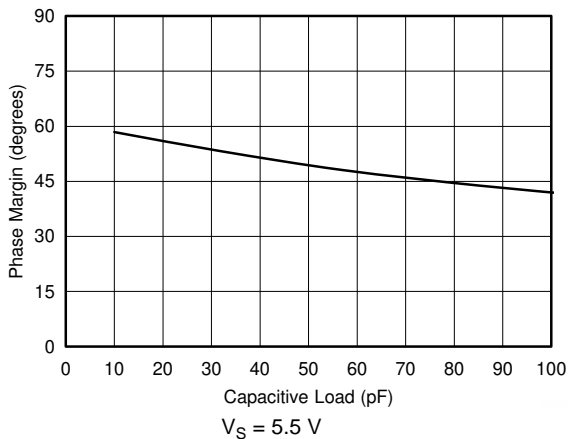
at $T_A = 25^\circ\text{C}$, $V_S = 5.5\text{ V}$, $R_L = 10\text{ k}\Omega$ connected to $V_S / 2$, $V_{CM} = V_S / 2$, and $V_{OUT} = V_S / 2$ (unless otherwise noted)

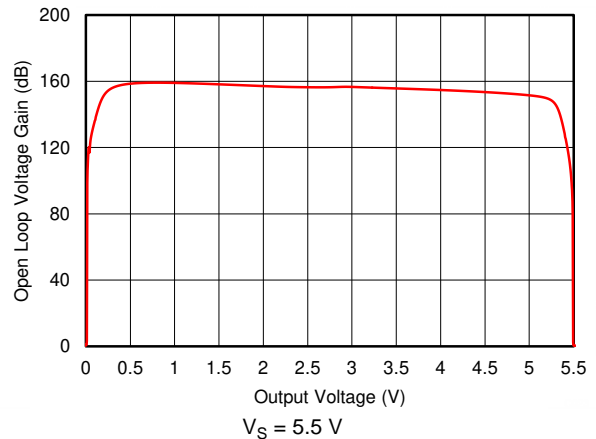

图 31. Large Signal Settling Time (Positive)

图 32. Large Signal Settling Time (Negative)

8 Detailed Description

8.1 Overview

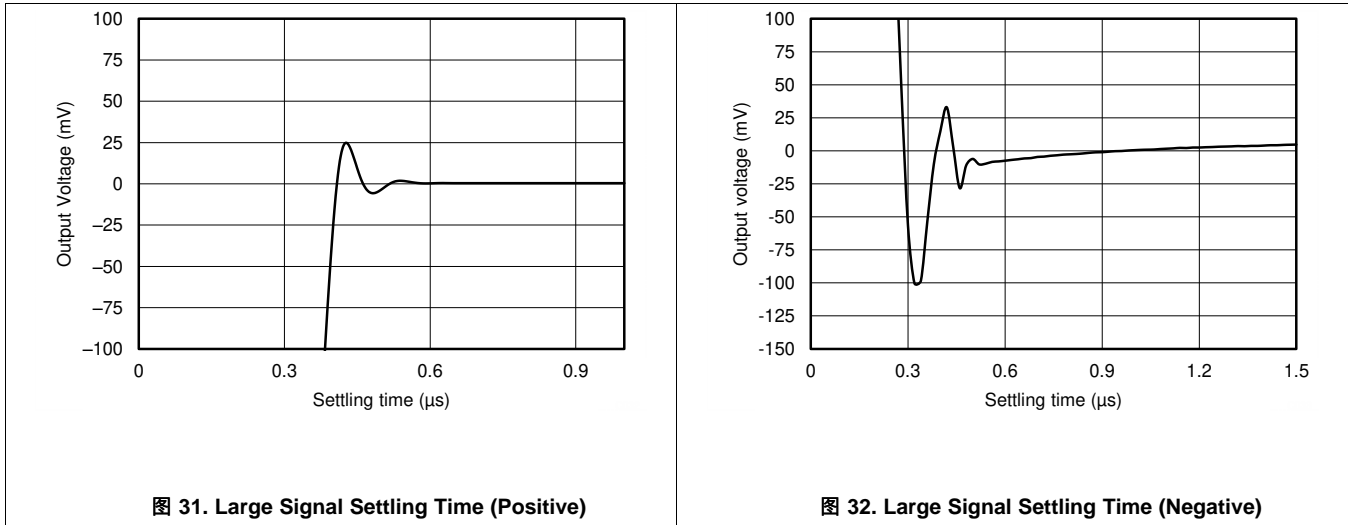
The MCP629x series is a family of low-power, rail-to-rail input and output op amps. These devices operate from 2.4 V to 5.5 V, are unity-gain stable, and are designed for a wide range of general-purpose applications. The input common-mode voltage range includes both rails and allows the MCP629x series to be used in any single-supply application. Rail-to-rail input and output swing significantly increases dynamic range in low-supply applications and are designed for driving sampling analog-to-digital converters (ADCs).

8.2 Functional Block Diagram

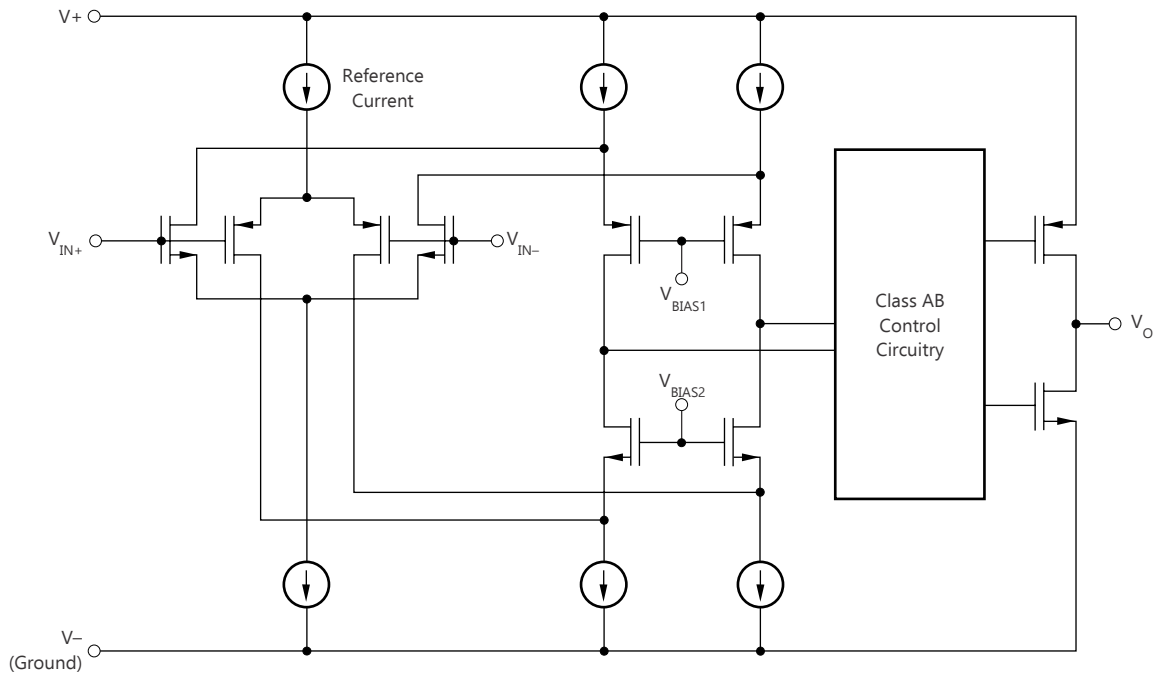

8.3 Feature Description

8.3.1 Rail-to-Rail Input

The input common-mode voltage range of the MCP629x family extends 100 mV beyond the supply rails for the full supply voltage range of 2.4 V to 5.5 V. This performance is achieved with a complementary input stage: an N-channel input differential pair in parallel with a P-channel differential pair, as the [Functional Block Diagram](#) shows. The N-channel pair is active for input voltages close to the positive rail, typically $(V+) - 1.4$ V to 100 mV above the positive supply, whereas the P-channel pair is active for inputs from 100 mV below the negative supply to approximately $(V+) - 1.4$ V. There is a small transition region, typically $(V+) - 1.2$ V to $(V+) - 1$ V, in which both pairs are on. This 200-mV transition region can vary up to 200 mV with process variation. Thus, the transition region (with both stages on) can range from $(V+) - 1.4$ V to $(V+) - 1.2$ V on the low end, and up to $(V+) - 1$ V to $(V+) - 0.8$ V on the high end. Within this transition region, PSRR, CMRR, offset voltage, offset drift, and THD can degrade compared to device operation outside this region.

8.3.2 Rail-to-Rail Output

Designed as a low-power, low-voltage operational amplifier, the MCP629x series delivers a robust output drive capability. A class AB output stage with common-source transistors achieves full rail-to-rail output swing capability. For resistive loads of 10 k Ω , the output swings to within 15 mV of either supply rail, regardless of the applied power-supply voltage. Different load conditions change the ability of the amplifier to swing close to the rails.

8.3.3 Overload Recovery

Overload recovery is defined as the time required for the operational amplifier output to recover from a saturated state to a linear state. The output devices of the operational amplifier enter a saturation region when the output voltage exceeds the rated operating voltage, because of the high input voltage or the high gain. After the device enters the saturation region, the charge carriers in the output devices require time to return to the linear state. After the charge carriers return to the linear state, the device begins to slew at the specified slew rate. Therefore, the propagation delay (in case of an overload condition) is the sum of the overload recovery time and the slew time. The overload recovery time for the MCP629x series is approximately 200 ns.

8.4 Device Functional Modes

The MCP629x family has a single functional mode. These devices are powered on as long as the power-supply voltage is between 2.4 V (± 1.2 V) and 5.5 V (± 2.75 V).

9 Application and Implementation

注

Information in the following applications sections is not part of the TI component specification, and TI does not warrant its accuracy or completeness. TI's customers are responsible for determining suitability of components for their purposes. Customers should validate and test their design implementation to confirm system functionality.

9.1 Application Information

The MCP629x series features 10-MHz bandwidth and 6.5-V/ μ s slew rate with only 600 μ A of supply current per channel, providing good AC performance at low power consumption. DC applications are well served with a low input noise voltage of 8.7 nV / $\sqrt{\text{Hz}}$ at 10 kHz, low input bias current, and a typical input offset voltage of 0.3 mV.

9.2 Typical Application

图 33 shows the MCP629x configured in a low-side, motor-control application.



图 33. MCP629x in a Low-Side, Motor-Control Application

9.2.1 Design Requirements

The design requirements for this design are:

- Load current: 0 A to 1 A
- Output voltage: 4.95 V
- Maximum shunt voltage: 100 mV

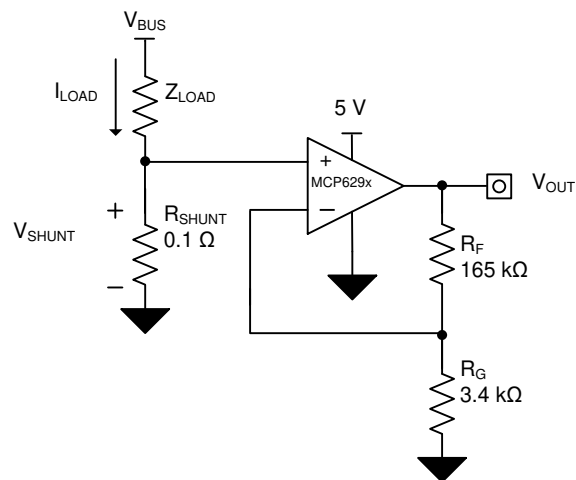
Typical Application (接下页)

9.2.2 Detailed Design Procedure

The transfer function of the circuit in 图 33 is shown in 公式 1.

$$V_{OUT} = I_{LOAD} \times R_{SHUNT} \times \text{Gain} \quad (1)$$

The load current (I_{LOAD}) produces a voltage drop across the shunt resistor (R_{SHUNT}). The load current is set from 0 A to 1 A. To keep the shunt voltage below 100 mV at maximum load current, the largest shunt resistor is defined using 公式 2.

$$R_{SHUNT} = \frac{V_{SHUNT_MAX}}{I_{LOAD_MAX}} = \frac{100\text{mV}}{1\text{A}} = 100\text{m}\Omega \quad (2)$$

Using 公式 2, R_{SHUNT} is 100 m Ω . The voltage drop produced by I_{LOAD} and R_{SHUNT} is amplified by the MCP629x to produce an output voltage of roughly 0 V to 4.95 V. The gain needed by the MCP629x to produce the necessary output voltage is calculated using 公式 3:

$$\text{Gain} = \frac{(V_{OUT_MAX} - V_{OUT_MIN})}{(V_{IN_MAX} - V_{IN_MIN})} \quad (3)$$

Using 公式 3, the required gain is calculated to be 49.5 V/V, which is set with resistors R_F and R_G . 公式 4 is used to size the resistors, R_F and R_G , to set the gain of the MCP629x to 49.5 V/V.

$$\text{Gain} = 1 + \frac{(R_F)}{(R_G)} \quad (4)$$

Choosing R_F as 165 k Ω and R_G as 3.4 k Ω provides a combination that equals roughly 49.5 V/V. 图 34 shows the measured transfer function of the circuit shown in 图 33.

9.2.3 Application Curve



图 34. Low-Side, Current-Sense Transfer Function

10 Power Supply Recommendations

The MCP629x series is specified for operation from 2.4 V to 5.5 V (± 1.2 V to ± 2.75 V); many specifications apply from -40°C to 125°C . The [Typical Characteristics](#) section presents parameters that can exhibit significant variance with regard to operating voltage or temperature.

CAUTION

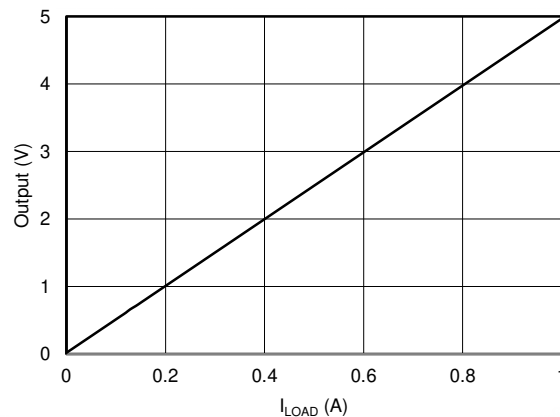
Supply voltages larger than 6 V can permanently damage the device; see the [Absolute Maximum Ratings](#) table.

Place 0.1- μF bypass capacitors close to the power-supply pins to reduce errors coupling in from noisy or high-impedance power supplies. For more detailed information on bypass capacitor placement, see the [Layout Example](#) section.

10.1 Input and ESD Protection

The MCP629x series incorporates internal ESD protection circuits on all pins. For input and output pins, this protection primarily consists of current-steering diodes connected between the input and power-supply pins. These ESD protection diodes provide in-circuit, input overdrive protection, as long as the current is limited to 10-mA, as stated in the [Absolute Maximum Ratings](#) table. [图 35](#) shows how a series input resistor is added to the driven input to limit the input current. The added resistor contributes thermal noise at the amplifier input and the value must be kept to a minimum in noise-sensitive applications.



图 35. Input Current Protection

11 Layout

11.1 Layout Guidelines

For best operational performance of the device, use good printed-circuit board (PCB) layout practices, including:

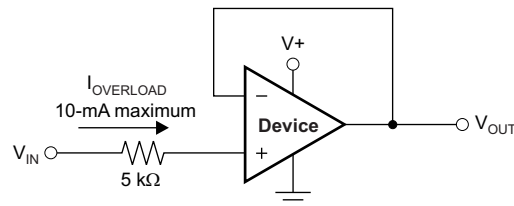
- Noise can propagate into analog circuitry through the power pins of the circuit as a whole and of op amp itself. Bypass capacitors reduce the coupled noise by providing low-impedance power sources local to the analog circuitry.
 - Connect low-ESR, 0.1- μ F ceramic bypass capacitors between each supply pin and ground, placed as close to the device as possible. A single bypass capacitor from V+ to ground is applicable for single-supply applications.
- Separate grounding for analog and digital portions of circuitry is one of the simplest and most-effective methods of noise suppression. One or more layers on multilayer PCBs are usually devoted to ground planes. A ground plane helps distribute heat and reduces electromagnetic interference (EMI) noise pickup. Make sure to physically separate digital and analog grounds, paying attention to the flow of the ground current. For more detailed information, see [Circuit Board Layout Techniques](#).
- To reduce parasitic coupling, run the input traces as far away from the supply or output traces as possible. If these traces cannot be kept separate, crossing the sensitive trace perpendicular is much better as opposed to in parallel with the noisy trace.
- Place the external components as close to the device as possible. As shown in [图 37](#), keeping RF and RG close to the inverting input minimizes parasitic capacitance on the inverting input.
- Keep the length of input traces as short as possible. Always remember that the input traces are the most sensitive part of the circuit.
- Consider a driven, low-impedance guard ring around the critical traces. A guard ring can significantly reduce leakage currents from nearby traces that are at different potentials.
- Cleaning the PCB following board assembly is recommended for best performance.
- Any precision integrated circuit can experience performance shifts resulting from moisture ingress into the plastic package. Following any aqueous PCB cleaning process, baking the PCB assembly is recommended to remove moisture introduced into the device packaging during the cleaning process. A low-temperature, post-cleaning bake at 85°C for 30 minutes is sufficient for most circumstances.

11.2 Layout Example



图 36. Schematic Representation for [图 37](#)



图 37. Layout Example

12 器件和文档支持

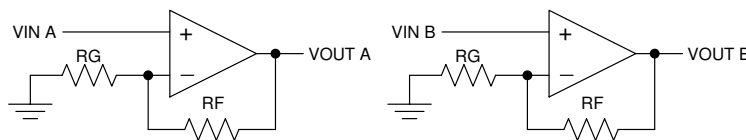
12.1 文档支持

12.1.1 相关文档

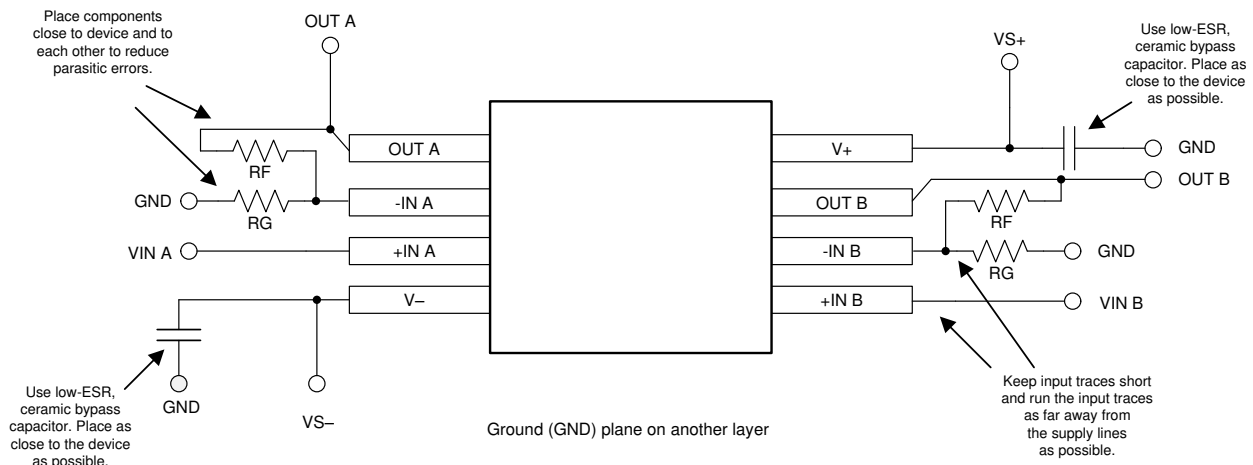
请参阅如下相关文档：

《电路板布局技巧》(SLOA089)

12.2 相关链接

下表列出了快速访问链接。类别包括技术文档、支持和社区资源、工具和软件，以及立即订购快速访问。

表 1. 相关链接

器件	产品文件夹	立即订购	技术文档	工具与软件	支持和社区
MCP6291	请单击此处	请单击此处	请单击此处	请单击此处	请单击此处
MCP6292	请单击此处	请单击此处	请单击此处	请单击此处	请单击此处
MCP6294	请单击此处	请单击此处	请单击此处	请单击此处	请单击此处

12.3 接收文档更新通知

要接收文档更新通知，请导航至 [ti.com](#) 上的器件产品文件夹。单击右上角的通知我进行注册，即可每周接收产品信息更改摘要。有关更改的详细信息，请查看任何已修订文档中包含的修订历史记录。

12.4 社区资源

TI E2E™ support forums are an engineer's go-to source for fast, verified answers and design help — straight from the experts. Search existing answers or ask your own question to get the quick design help you need.

Linked content is provided "AS IS" by the respective contributors. They do not constitute TI specifications and do not necessarily reflect TI's views; see TI's [Terms of Use](#).

12.5 商标

E2E is a trademark of Texas Instruments.

All other trademarks are the property of their respective owners.

12.6 静电放电警告



ESD 可能会损坏该集成电路。德州仪器 (TI) 建议通过适当的预防措施处理所有集成电路。如果不遵守正确的处理措施和安装程序，可能会损坏集成电路。

ESD 的损坏小至导致微小的性能降级，大至整个器件故障。精密的集成电路可能更容易受到损坏，这是因为非常细微的参数更改都可能会导致器件与其发布的规格不相符。

12.7 Glossary

[SLYZ022](#) — TI Glossary.

This glossary lists and explains terms, acronyms, and definitions.

13 机械、封装和可订购信息

以下页面包含机械、封装和可订购信息。这些信息是指定器件的最新可用数据。数据如有变更，恕不另行通知，且不会对此文档进行修订。如需获取此数据表的浏览器版本，请查阅左侧的导航栏。

PACKAGING INFORMATION

Orderable Device	Status (1)	Package Type	Package Drawing	Pins	Package Qty	Eco Plan (2)	Lead finish/ Ball material (6)	MSL Peak Temp (3)	Op Temp (°C)	Device Marking (4/5)	Samples
MCP6291IDBVR	ACTIVE	SOT-23	DBV	5	3000	RoHS & Green	NIPDAU SN	Level-1-260C-UNLIM	-40 to 125	1U3F	Samples
MCP6291IDCKR	ACTIVE	SC70	DCK	5	3000	RoHS & Green	SN	Level-2-260C-1 YEAR	-40 to 125	1EL	Samples
MCP6292IDDFR	ACTIVE	SOT-23-THIN	DDF	8	3000	RoHS & Green	NIPDAU	Level-1-260C-UNLIM	-40 to 125	M292	Samples
MCP6292IDGKR	ACTIVE	VSSOP	DGK	8	2500	RoHS & Green	NIPDAU SN NIPDAUAG	Level-2-260C-1 YEAR	-40 to 125	M292	Samples
MCP6292IDGKT	ACTIVE	VSSOP	DGK	8	250	RoHS & Green	NIPDAU SN NIPDAUAG	Level-2-260C-1 YEAR	-40 to 125	M292	Samples
MCP6292IDR	ACTIVE	SOIC	D	8	2500	RoHS & Green	NIPDAU SN	Level-2-260C-1 YEAR	-40 to 125	MC6292	Samples
MCP6294IDR	ACTIVE	SOIC	D	14	2500	RoHS & Green	NIPDAU	Level-2-260C-1 YEAR	-40 to 125	MCP6294D	Samples
MCP6294IPWR	ACTIVE	TSSOP	PW	14	2000	RoHS & Green	SN	Level-2-260C-1 YEAR	-40 to 125	MCP6294	Samples
MCP6294IPWT	ACTIVE	TSSOP	PW	14	250	RoHS & Green	SN	Level-2-260C-1 YEAR	-40 to 125	MCP6294	Samples

(1) The marketing status values are defined as follows:

ACTIVE: Product device recommended for new designs.

LIFEBUY: TI has announced that the device will be discontinued, and a lifetime-buy period is in effect.

NRND: Not recommended for new designs. Device is in production to support existing customers, but TI does not recommend using this part in a new design.

PREVIEW: Device has been announced but is not in production. Samples may or may not be available.

OBSOLETE: TI has discontinued the production of the device.

(2) **RoHS:** TI defines "RoHS" to mean semiconductor products that are compliant with the current EU RoHS requirements for all 10 RoHS substances, including the requirement that RoHS substance do not exceed 0.1% by weight in homogeneous materials. Where designed to be soldered at high temperatures, "RoHS" products are suitable for use in specified lead-free processes. TI may reference these types of products as "Pb-Free".

RoHS Exempt: TI defines "RoHS Exempt" to mean products that contain lead but are compliant with EU RoHS pursuant to a specific EU RoHS exemption.

Green: TI defines "Green" to mean the content of Chlorine (Cl) and Bromine (Br) based flame retardants meet JS709B low halogen requirements of <=1000ppm threshold. Antimony trioxide based flame retardants must also meet the <=1000ppm threshold requirement.

(3) MSL, Peak Temp. - The Moisture Sensitivity Level rating according to the JEDEC industry standard classifications, and peak solder temperature.

(4) There may be additional marking, which relates to the logo, the lot trace code information, or the environmental category on the device.

⁽⁵⁾ Multiple Device Markings will be inside parentheses. Only one Device Marking contained in parentheses and separated by a "~" will appear on a device. If a line is indented then it is a continuation of the previous line and the two combined represent the entire Device Marking for that device.

⁽⁶⁾ Lead finish/Ball material - Orderable Devices may have multiple material finish options. Finish options are separated by a vertical ruled line. Lead finish/Ball material values may wrap to two lines if the finish value exceeds the maximum column width.

Important Information and Disclaimer:The information provided on this page represents TI's knowledge and belief as of the date that it is provided. TI bases its knowledge and belief on information provided by third parties, and makes no representation or warranty as to the accuracy of such information. Efforts are underway to better integrate information from third parties. TI has taken and continues to take reasonable steps to provide representative and accurate information but may not have conducted destructive testing or chemical analysis on incoming materials and chemicals. TI and TI suppliers consider certain information to be proprietary, and thus CAS numbers and other limited information may not be available for release.

In no event shall TI's liability arising out of such information exceed the total purchase price of the TI part(s) at issue in this document sold by TI to Customer on an annual basis.

TAPE AND REEL INFORMATION

QUADRANT ASSIGNMENTS FOR PIN 1 ORIENTATION IN TAPE

*All dimensions are nominal

Device	Package Type	Package Drawing	Pins	SPQ	Reel Diameter (mm)	Reel Width W1 (mm)	A0 (mm)	B0 (mm)	K0 (mm)	P1 (mm)	W (mm)	Pin1 Quadrant
MCP6291IDBVR	SOT-23	DBV	5	3000	180.0	8.4	3.2	3.2	1.4	4.0	8.0	Q3
MCP6291IDBVR	SOT-23	DBV	5	3000	180.0	8.4	3.2	3.2	1.4	4.0	8.0	Q3
MCP6291IDCKR	SC70	DCK	5	3000	178.0	9.0	2.4	2.5	1.2	4.0	8.0	Q3
MCP6292IDDFR	SOT-23-THIN	DDF	8	3000	180.0	8.4	3.2	3.2	1.4	4.0	8.0	Q3
MCP6292IDGKR	VSSOP	DGK	8	2500	330.0	12.4	5.3	3.4	1.4	8.0	12.0	Q1
MCP6292IDGKR	VSSOP	DGK	8	2500	330.0	12.4	5.3	3.4	1.4	8.0	12.0	Q1
MCP6292IDGKT	VSSOP	DGK	8	250	330.0	12.4	5.3	3.4	1.4	8.0	12.0	Q1
MCP6292IDGKT	VSSOP	DGK	8	250	330.0	12.4	5.3	3.4	1.4	8.0	12.0	Q1
MCP6292IDGKT	VSSOP	DGK	8	250	330.0	12.4	5.3	3.4	1.4	8.0	12.0	Q1
MCP6292IDR	SOIC	D	8	2500	330.0	12.4	6.4	5.2	2.1	8.0	12.0	Q1
MCP6294IDR	SOIC	D	14	2500	330.0	16.4	6.5	9.0	2.1	8.0	16.0	Q1
MCP6294IPWR	TSSOP	PW	14	2000	330.0	12.4	6.9	5.6	1.6	8.0	12.0	Q1
MCP6294IPWT	TSSOP	PW	14	250	330.0	12.4	6.9	5.6	1.6	8.0	12.0	Q1

TAPE AND REEL BOX DIMENSIONS

*All dimensions are nominal

Device	Package Type	Package Drawing	Pins	SPQ	Length (mm)	Width (mm)	Height (mm)
MCP6291IDBVR	SOT-23	DBV	5	3000	210.0	185.0	35.0
MCP6291IDBVR	SOT-23	DBV	5	3000	210.0	185.0	35.0
MCP6291IDCKR	SC70	DCK	5	3000	190.0	190.0	30.0
MCP6292IDDFR	SOT-23-THIN	DDF	8	3000	210.0	185.0	35.0
MCP6292IDGKR	VSSOP	DGK	8	2500	366.0	364.0	50.0
MCP6292IDGKR	VSSOP	DGK	8	2500	366.0	364.0	50.0
MCP6292IDGKT	VSSOP	DGK	8	250	356.0	356.0	35.0
MCP6292IDGKT	VSSOP	DGK	8	250	366.0	364.0	50.0
MCP6292IDGKT	VSSOP	DGK	8	250	366.0	364.0	50.0
MCP6292IDR	SOIC	D	8	2500	356.0	356.0	35.0
MCP6294IDR	SOIC	D	14	2500	356.0	356.0	35.0
MCP6294IPWR	TSSOP	PW	14	2000	366.0	364.0	50.0
MCP6294IPWT	TSSOP	PW	14	250	366.0	364.0	50.0

DBV0005A



PACKAGE OUTLINE

SOT-23 - 1.45 mm max height

SMALL OUTLINE TRANSISTOR

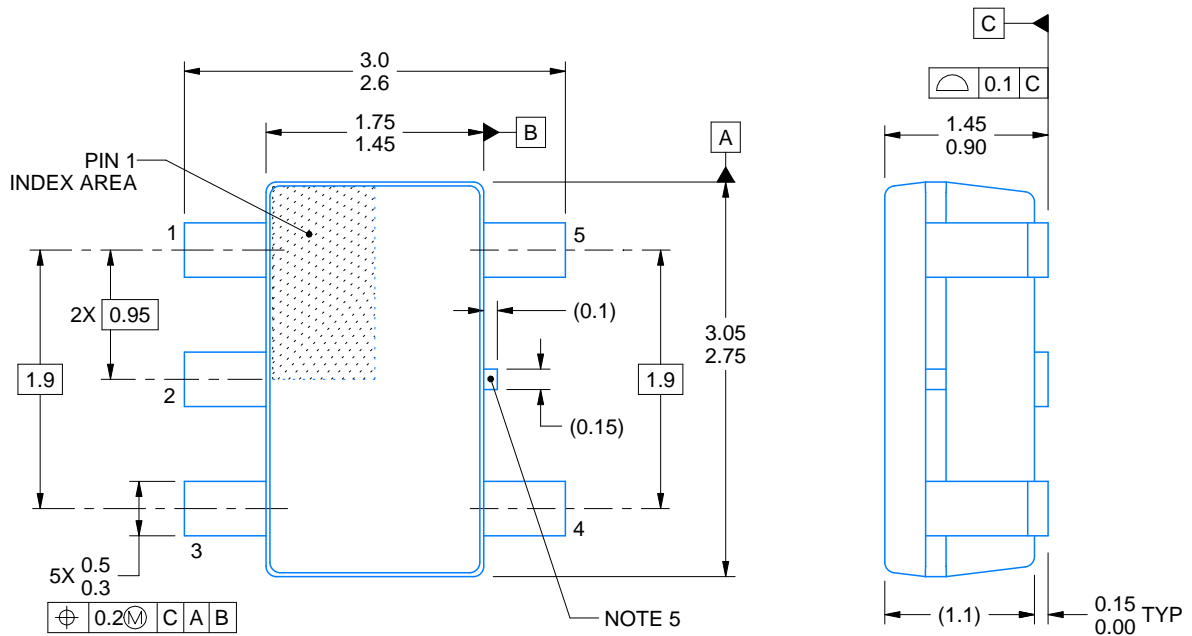

4214839/G 03/2023

NOTES:

1. All linear dimensions are in millimeters. Any dimensions in parenthesis are for reference only. Dimensioning and tolerancing per ASME Y14.5M.
2. This drawing is subject to change without notice.
3. Reference JEDEC MO-178.
4. Body dimensions do not include mold flash, protrusions, or gate burrs. Mold flash, protrusions, or gate burrs shall not exceed 0.25 mm per side.
5. Support pin may differ or may not be present.

EXAMPLE BOARD LAYOUT

DBV0005A

SOT-23 - 1.45 mm max height

SMALL OUTLINE TRANSISTOR



LAND PATTERN EXAMPLE
EXPOSED METAL SHOWN
SCALE:15X

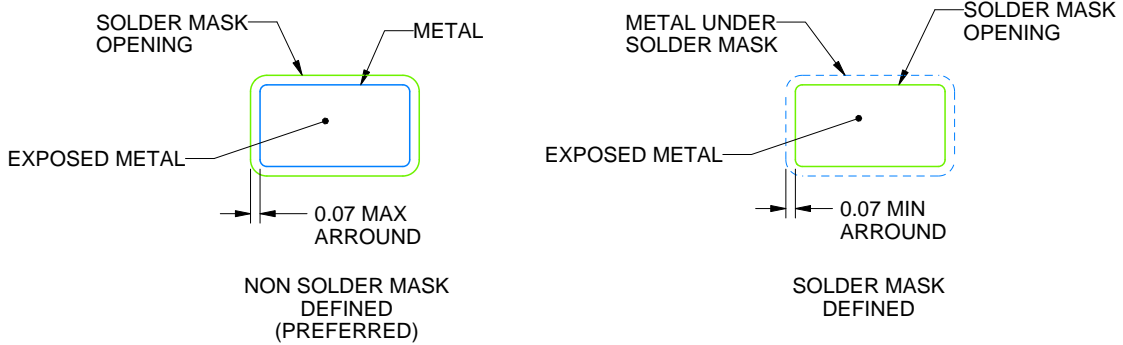

SOLDER MASK DETAILS

4214839/G 03/2023

NOTES: (continued)

- 6. Publication IPC-7351 may have alternate designs.
- 7. Solder mask tolerances between and around signal pads can vary based on board fabrication site.

EXAMPLE STENCIL DESIGN

DBV0005A

SOT-23 - 1.45 mm max height

SMALL OUTLINE TRANSISTOR



SOLDER PASTE EXAMPLE
BASED ON 0.125 mm THICK STENCIL
SCALE:15X

4214839/G 03/2023

NOTES: (continued)

8. Laser cutting apertures with trapezoidal walls and rounded corners may offer better paste release. IPC-7525 may have alternate design recommendations.
9. Board assembly site may have different recommendations for stencil design.

D (R-PDSO-G14)

PLASTIC SMALL OUTLINE



- NOTES:
- A. All linear dimensions are in inches (millimeters).
 - B. This drawing is subject to change without notice.
 - Body length does not include mold flash, protrusions, or gate burrs. Mold flash, protrusions, or gate burrs shall not exceed 0.006 (0,15) each side.
 - Body width does not include interlead flash. Interlead flash shall not exceed 0.017 (0,43) each side.
 - E. Reference JEDEC MS-012 variation AB.

PW (R-PDSO-G14)

PLASTIC SMALL OUTLINE



- NOTES:
- A. All linear dimensions are in millimeters. Dimensioning and tolerancing per ASME Y14.5M-1994.
 - B. This drawing is subject to change without notice.
 - C. Body length does not include mold flash, protrusions, or gate burrs. Mold flash, protrusions, or gate burrs shall not exceed 0,15 each side.
 - D. Body width does not include interlead flash. Interlead flash shall not exceed 0,25 each side.
 - E. Falls within JEDEC MO-153

PW (R-PDSO-G14)

PLASTIC SMALL OUTLINE



4211284-2/G 08/15

- NOTES:
- A. All linear dimensions are in millimeters.
 - B. This drawing is subject to change without notice.
 - C. Publication IPC-7351 is recommended for alternate designs.
 - D. Laser cutting apertures with trapezoidal walls and also rounding corners will offer better paste release. Customers should contact their board assembly site for stencil design recommendations. Refer to IPC-7525 for other stencil recommendations.
 - E. Customers should contact their board fabrication site for solder mask tolerances between and around signal pads.



D0008A

PACKAGE OUTLINE

SOIC - 1.75 mm max height

SMALL OUTLINE INTEGRATED CIRCUIT



4214825/C 02/2019

NOTES:

1. Linear dimensions are in inches [millimeters]. Dimensions in parenthesis are for reference only. Controlling dimensions are in inches. Dimensioning and tolerancing per ASME Y14.5M.
2. This drawing is subject to change without notice.
3. This dimension does not include mold flash, protrusions, or gate burrs. Mold flash, protrusions, or gate burrs shall not exceed $.006$ [0.15] per side.
4. This dimension does not include interlead flash.
5. Reference JEDEC registration MS-012, variation AA.

EXAMPLE BOARD LAYOUT

D0008A

SOIC - 1.75 mm max height

SMALL OUTLINE INTEGRATED CIRCUIT



LAND PATTERN EXAMPLE
 EXPOSED METAL SHOWN
 SCALE:8X



SOLDER MASK DETAILS

4214825/C 02/2019

NOTES: (continued)

- 6. Publication IPC-7351 may have alternate designs.
- 7. Solder mask tolerances between and around signal pads can vary based on board fabrication site.

EXAMPLE STENCIL DESIGN

D0008A

SOIC - 1.75 mm max height

SMALL OUTLINE INTEGRATED CIRCUIT



SOLDER PASTE EXAMPLE
BASED ON .005 INCH [0.125 MM] THICK STENCIL
SCALE:8X

4214825/C 02/2019

NOTES: (continued)

8. Laser cutting apertures with trapezoidal walls and rounded corners may offer better paste release. IPC-7525 may have alternate design recommendations.
9. Board assembly site may have different recommendations for stencil design.

DGK (S-PDSO-G8)

PLASTIC SMALL-OUTLINE PACKAGE



- NOTES:
- A. All linear dimensions are in millimeters.
 - B. This drawing is subject to change without notice.
 - C. Body length does not include mold flash, protrusions, or gate burrs. Mold flash, protrusions, or gate burrs shall not exceed 0.15 per end.
 - D. Body width does not include interlead flash. Interlead flash shall not exceed 0.50 per side.
 - E. Falls within JEDEC MO-187 variation AA, except interlead flash.



- NOTES:
- A. All linear dimensions are in millimeters.
 - B. This drawing is subject to change without notice.
 - C. Publication IPC-7351 is recommended for alternate designs.
 - D. Laser cutting apertures with trapezoidal walls and also rounding corners will offer better paste release. Customers should contact their board assembly site for stencil design recommendations. Refer to IPC-7525 for other stencil recommendations.
 - E. Customers should contact their board fabrication site for solder mask tolerances between and around signal pads.

DCK0005A



PACKAGE OUTLINE

SOT - 1.1 max height

SMALL OUTLINE TRANSISTOR



4214834/C 03/2023

NOTES:

1. All linear dimensions are in millimeters. Any dimensions in parenthesis are for reference only. Dimensioning and tolerancing per ASME Y14.5M.
2. This drawing is subject to change without notice.
3. Reference JEDEC MO-203.
4. Support pin may differ or may not be present.

EXAMPLE BOARD LAYOUT

DCK0005A

SOT - 1.1 max height

SMALL OUTLINE TRANSISTOR

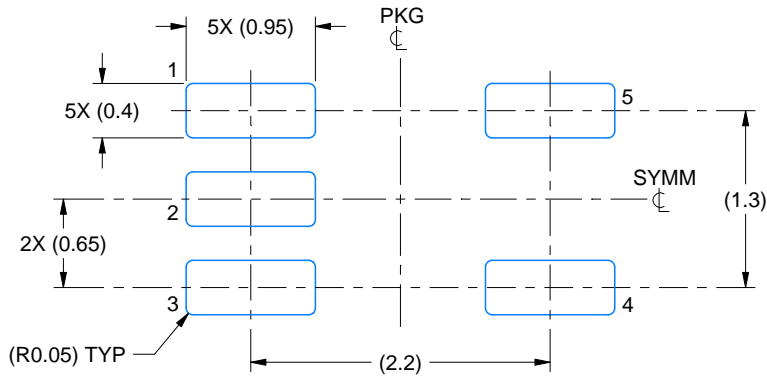

LAND PATTERN EXAMPLE
EXPOSED METAL SHOWN
SCALE:18X



SOLDER MASK DETAILS

4214834/C 03/2023

NOTES: (continued)

- 4. Publication IPC-7351 may have alternate designs.
- 5. Solder mask tolerances between and around signal pads can vary based on board fabrication site.

EXAMPLE STENCIL DESIGN

DCK0005A

SOT - 1.1 max height

SMALL OUTLINE TRANSISTOR

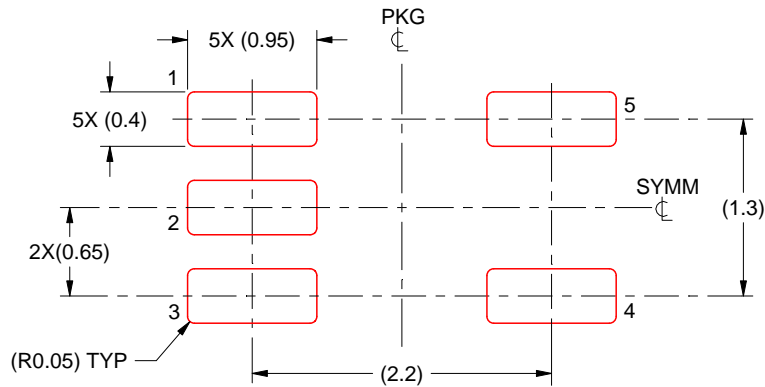

SOLDER PASTE EXAMPLE
BASED ON 0.125 THICK STENCIL
SCALE:18X

4214834/C 03/2023

NOTES: (continued)

6. Laser cutting apertures with trapezoidal walls and rounded corners may offer better paste release. IPC-7525 may have alternate design recommendations.
7. Board assembly site may have different recommendations for stencil design.

DDF0008A



PACKAGE OUTLINE

SOT-23 - 1.1 mm max height

PLASTIC SMALL OUTLINE



4222047/C 10/2022

NOTES:

1. All linear dimensions are in millimeters. Any dimensions in parenthesis are for reference only. Dimensioning and tolerancing per ASME Y14.5M.
2. This drawing is subject to change without notice.
3. This dimension does not include mold flash, protrusions, or gate burrs. Mold flash, protrusions, or gate burrs shall not exceed 0.15 mm per side.

EXAMPLE BOARD LAYOUT

DDF0008A

SOT-23 - 1.1 mm max height

PLASTIC SMALL OUTLINE



LAND PATTERN EXAMPLE
SCALE:15X



NON SOLDER MASK
DEFINED



SOLDER MASK
DEFINED

SOLDER MASK DETAILS

4222047/C 10/2022

NOTES: (continued)

4. Publication IPC-7351 may have alternate designs.
5. Solder mask tolerances between and around signal pads can vary based on board fabrication site.

EXAMPLE STENCIL DESIGN

DDF0008A

SOT-23 - 1.1 mm max height

PLASTIC SMALL OUTLINE



SOLDER PASTE EXAMPLE
BASED ON 0.125 mm THICK STENCIL
SCALE:15X

4222047/C 10/2022

NOTES: (continued)

6. Laser cutting apertures with trapezoidal walls and rounded corners may offer better paste release. IPC-7525 may have alternate design recommendations.
7. Board assembly site may have different recommendations for stencil design.

重要声明和免责声明

TI“按原样”提供技术和可靠性数据（包括数据表）、设计资源（包括参考设计）、应用或其他设计建议、网络工具、安全信息和其他资源，不保证没有瑕疵且不做任何明示或暗示的担保，包括但不限于对适销性、某特定用途方面的适用性或不侵犯任何第三方知识产权的暗示担保。

这些资源可供使用 TI 产品进行设计的熟练开发人员使用。您将自行承担以下全部责任：(1) 针对您的应用选择合适的 TI 产品，(2) 设计、验证并测试您的应用，(3) 确保您的应用满足相应标准以及任何其他功能安全、信息安全、监管或其他要求。

这些资源如有变更，恕不另行通知。TI 授权您仅可将这些资源用于研发本资源所述的 TI 产品的应用。严禁对这些资源进行其他复制或展示。您无权使用任何其他 TI 知识产权或任何第三方知识产权。您应全额赔偿因在这些资源的使用中对 TI 及其代表造成的任何索赔、损害、成本、损失和债务，TI 对此概不负责。

TI 提供的产品受 [TI 的销售条款](#) 或 [ti.com](#) 上其他适用条款/TI 产品随附的其他适用条款的约束。TI 提供这些资源并不会扩展或以其他方式更改 TI 针对 TI 产品发布的适用的担保或担保免责声明。

TI 反对并拒绝您可能提出的任何其他或不同的条款。

邮寄地址：Texas Instruments, Post Office Box 655303, Dallas, Texas 75265

Copyright © 2023，德州仪器 (TI) 公司