

General-Purpose FET-INPUT OPERATIONAL AMPLIFIERS

FEATURES

- FET INPUT: $I_b = 50\text{pA max}$
- LOW OFFSET VOLTAGE: $750\mu\text{V max}$
- WIDE SUPPLY RANGE: $\pm 4.5\text{V to } \pm 18\text{V}$
- SLEW RATE: $10\text{V}/\mu\text{s}$
- WIDE BANDWIDTH: 4MHz
- EXCELLENT CAPACITIVE LOAD DRIVE
- SINGLE, DUAL, QUAD VERSIONS

DESCRIPTION

The OPA131 series of FET-input op amps provides high performance at low cost. Single, dual, and quad versions in industry-standard pinouts allow cost-effective design options.

The OPA131 series offers excellent general-purpose performance, including low offset voltage, drift, and good dynamic characteristics.

Single, dual, and quad versions are available in DIP and SO packages. Performance grades include commercial and industrial temperature ranges.

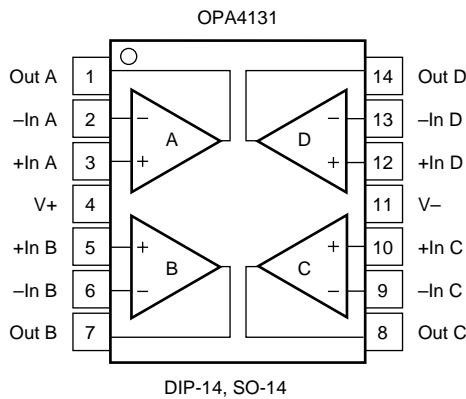
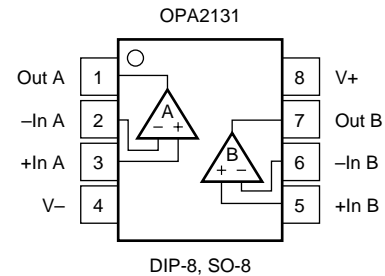
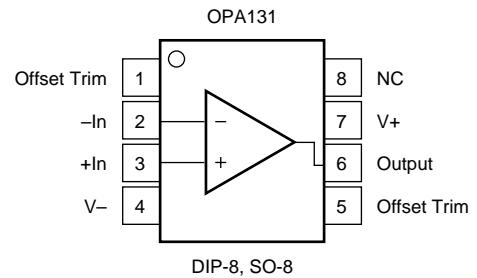

NC = No Connection

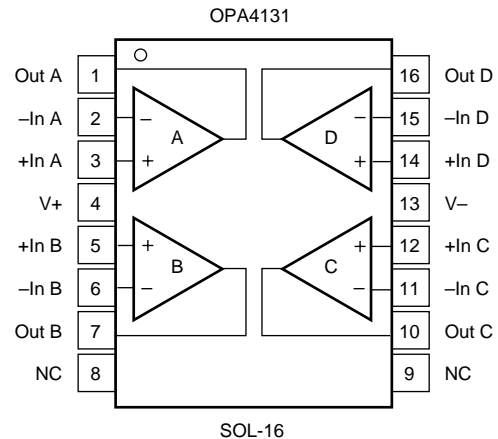

Please be aware that an important notice concerning availability, standard warranty, and use in critical applications of Texas Instruments semiconductor products and disclaimers thereto appears at the end of this data sheet.

ABSOLUTE MAXIMUM RATINGS⁽¹⁾

Supply Voltage, V+ to V-	36V
Input Voltage	(V-) - 0.7V to (V+) + 0.7V
Output Short-Circuit ⁽²⁾	Continuous
Operating Temperature	-55°C to +125°C
Storage Temperature	-55°C to +125°C
Junction Temperature	150°C
Lead Temperature (soldering, 10s)	300°C

NOTES: (1) Stresses above these ratings may cause permanent damage. Exposure to absolute maximum conditions for extended periods may degrade device reliability. (2) Short-circuit to ground, one amplifier per package.



ELECTROSTATIC DISCHARGE SENSITIVITY

This integrated circuit can be damaged by ESD. Texas Instruments recommends that all integrated circuits be handled with appropriate precautions. Failure to observe proper handling and installation procedures can cause damage.

ESD damage can range from subtle performance degradation to complete device failure. Precision integrated circuits may be more susceptible to damage because very small parametric changes could cause the device not to meet its published specifications.

PACKAGE/ORDERING INFORMATION

PRODUCT	PACKAGE-LEAD	PACKAGE DESIGNATOR ⁽¹⁾	SPECIFIED TEMPERATURE RANGE	PACKAGE MARKING	ORDERING NUMBER	TRANSPORT MEDIA, QUANTITY
Single						
OPA131	SO-8	D	-40°C to +85°C	OPA131UJ	OPA131UJ	Rails, 100
"	"	"	"	"	OPA131UJ/2K5	Tape and Reel, 2500
OPA131	SO-8	D	-40°C to +85°C	OPA131UA	OPA131UA	Rails, 100
"	"	"	"	"	OPA131UA/2K5	Tape and Reel, 2500
OPA131	SO-8	D	-40°C to +85°C	OPA131U	OPA131U	Rails, 100
"	"	"	"	"	OPA131U/2K5	Tape and Reel, 2500
Dual						
OPA2131	SO-8	D	-40°C to +85°C	OPA2131UJ	OPA2131UJ	Rails, 100
"	"	"	"	"	OPA2131UJ/2K5	Tape and Reel, 2500
OPA2131	SO-8	D	-40°C to +85°C	OPA2131UA	OPA2131UA	Rails, 100
"	"	"	"	"	OPA2131UA/2K5	Tape and Reel, 2500
Quad						
OPA4131	DIP-14	N	-40°C to +85°C	OPA4131PJ	OPA4131PJ	Rails, 25
"	"	"	"	OPA4131PA	OPA4131PA	Rails, 25
OPA4131	SOL-16	DW	-40°C to +85°C	OPA4131UA	OPA4131UA	Rails, 48
"	"	"	"	"	OPA4131UA/1K	Tape and Reel, 1000
OPA4131	SOL-14	D	-40°C to +85°C	OPA4131NJ	OPA4131NJ	Rails, 58
"	"	"	"	OPA4131NA	OPA4131NA	Rails, 58

NOTE: (1) For the most current specifications and package information, refer to our web site at www.ti.com.

ELECTRICAL CHARACTERISTICS

At $T_A = +25^\circ\text{C}$, $V_S = \pm 15\text{V}$, and $R_L = 2\text{k}\Omega$, unless otherwise noted.

PARAMETER	CONDITION	OPA131UA OPA2131UA OPA4131PA, UA, NA			OPA131UJ OPA2131UJ OPA4131PJ, NJ			UNITS
		MIN	TYP	MAX	MIN	TYP	MAX	
OFFSET VOLTAGE Input Offset Voltage OPA131U model only vs Temperature ⁽¹⁾ vs Power Supply OPA131U model only	Operating Temperature Range $V_S = \pm 4.5\text{V to } \pm 18\text{V}$		± 0.2 ± 0.2 ± 2 50 50	± 1 0.75 ± 10 200 100		*	± 1.5 * *	mV mV $\mu\text{V}/^\circ\text{C}$ $\mu\text{V}/\text{V}$ $\mu\text{V}/\text{V}$
INPUT BIAS CURRENT⁽²⁾ Input Bias Current vs Temperature Input Offset Current		$V_{\text{CM}} = 0\text{V}$ $V_{\text{CM}} = 0\text{V}$		+5 See Typical Characteristic ± 1	± 50 ± 50		*	* * *
NOISE Input Voltage Noise Noise Density, $f = 10\text{Hz}$ $f = 100\text{Hz}$ $f = 1\text{kHz}$ $f = 10\text{kHz}$ Current Noise Density, $f = 1\text{kHz}$			21 16 15 15 3			*	*	$\text{nV}/\sqrt{\text{Hz}}$ $\text{nV}/\sqrt{\text{Hz}}$ $\text{nV}/\sqrt{\text{Hz}}$ $\text{nV}/\sqrt{\text{Hz}}$ $\text{fA}/\sqrt{\text{Hz}}$
INPUT VOLTAGE RANGE Common-Mode Voltage Range Common-Mode Rejection OPA131U model only	$V_{\text{CM}} = -12\text{V to } +14\text{V}$	(V-) + 3 70 80	80 86	(V+) - 1	*	*	*	V dB dB
INPUT IMPEDANCE Differential Common-Mode	$V_{\text{CM}} = 0\text{V}$		$10^{10} \parallel 1$ $10^{12} \parallel 3$			*	*	$\Omega \parallel \text{pF}$ $\Omega \parallel \text{pF}$
OPEN-LOOP GAIN Open-Loop Voltage Gain OPA131U model only	$V_O = -12\text{V to } +12\text{V}$	94 100	110 110		*	*		dB dB
FREQUENCY RESPONSE Gain-Bandwidth Product Slew Rate Settling Time 0.1% 0.01% Total Harmonic Distortion + Noise	$G = -1, 10\text{V Step}, C_L = 100\text{pF}$ $G = -1, 10\text{V Step}, C_L = 100\text{pF}$ 1kHz, $G = 1, V_O = 3.5\text{Vrms}$		4 10 1.5 2 0.0008			*	*	MHz V/ μs μs μs %
OUTPUT Voltage Output, Positive Negative Short-Circuit Current		(V+) - 3 (V-) + 3	(V+) - 2.5 (V-) + 2.5 ± 25		*	*	*	V V mA
POWER SUPPLY Specified Operating Voltage Operating Voltage Range Quiescent Current (per amplifier)	$I_O = 0$	± 4.5	± 15 ± 1.5	± 18 ± 1.75	*	*	* ± 2	V V mA
TEMPERATURE RANGE Operating Range Storage Thermal Resistance, θ_{JA} DIP-8 SO-8 DIP-14 SO-14, SOL-16		-55 -55		+125 +125	-55 *		+125 *	$^\circ\text{C}$ $^\circ\text{C}$ $^\circ\text{C}/\text{W}$ $^\circ\text{C}/\text{W}$ $^\circ\text{C}/\text{W}$ $^\circ\text{C}/\text{W}$

* Specifications same as OPA131UA.

NOTES: (1) Ensured by wafer test. (2) High-speed test at $T_J = 25^\circ\text{C}$.

TYPICAL CHARACTERISTICS

At $T_A = +25^\circ\text{C}$, $V_S = \pm 15\text{V}$, and $R_L = 2\text{k}\Omega$, unless otherwise noted.

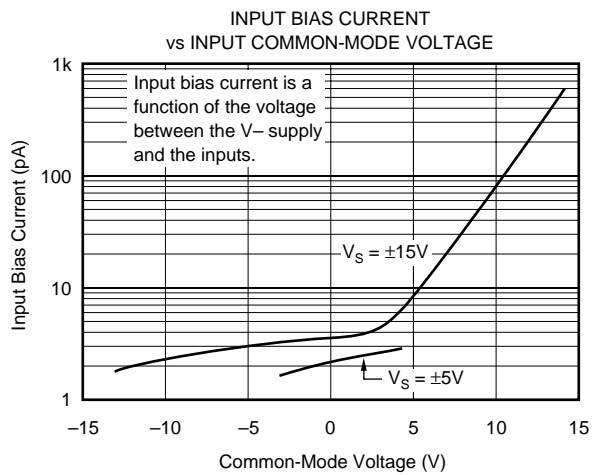
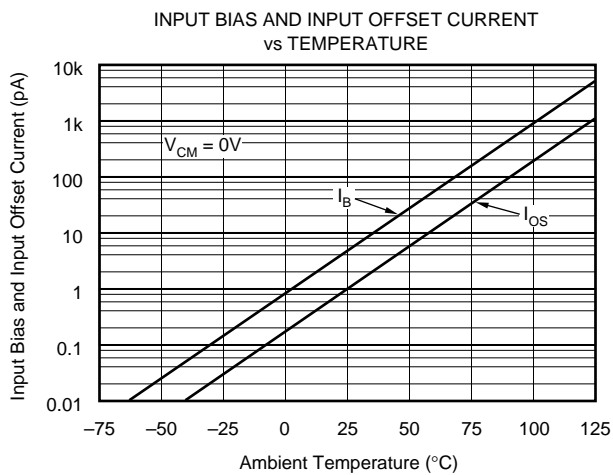
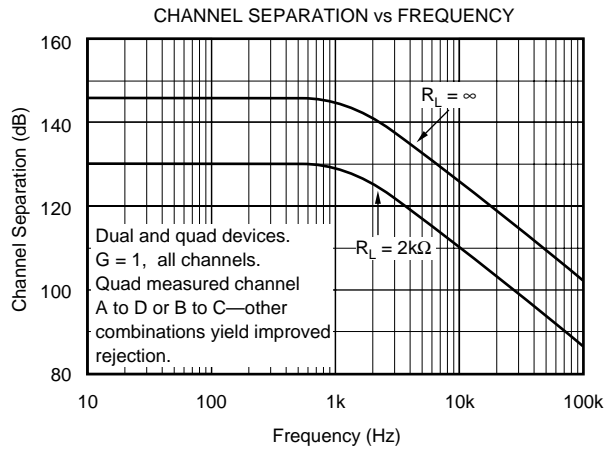
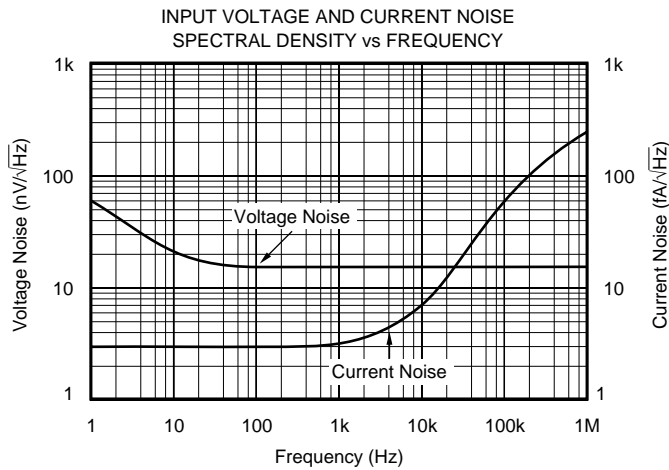
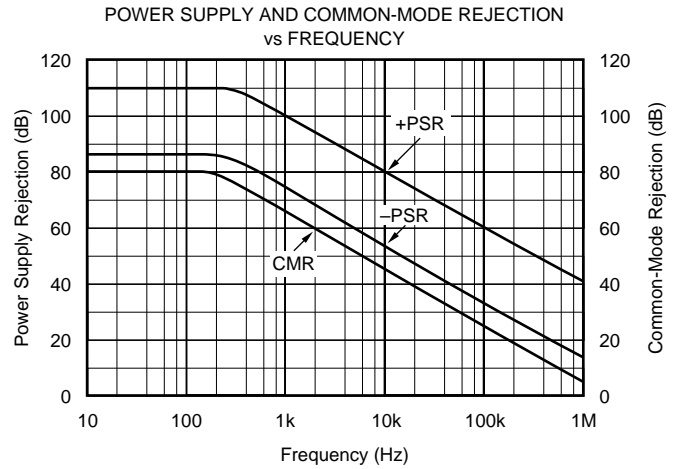
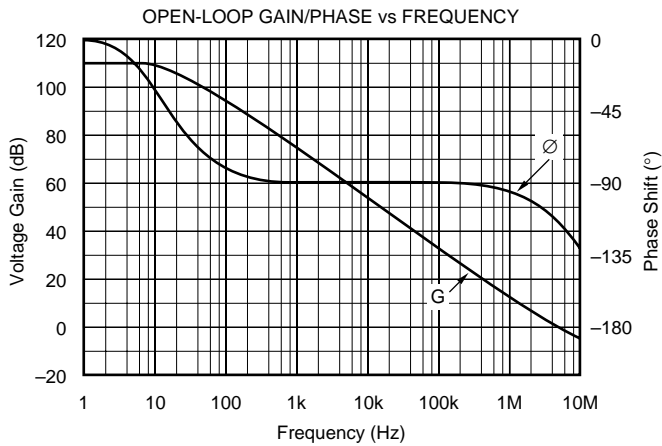

TYPICAL CHARACTERISTICS (Cont.)

At $T_A = +25^\circ\text{C}$, $V_S = \pm 15\text{V}$, and $R_L = 2\text{k}\Omega$, unless otherwise noted.

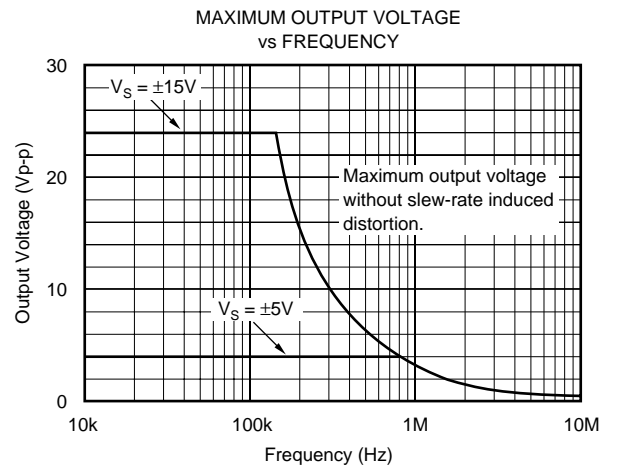
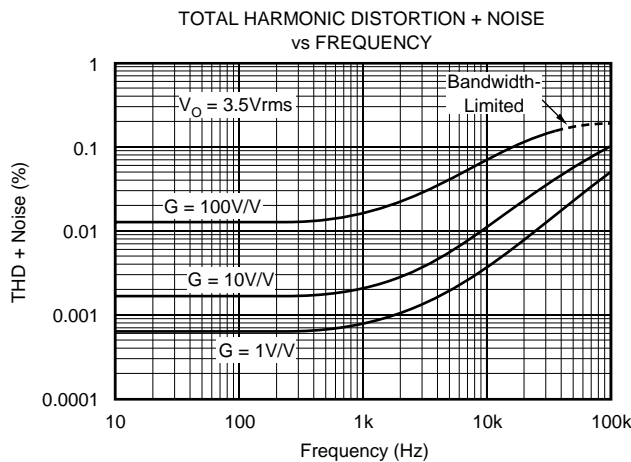
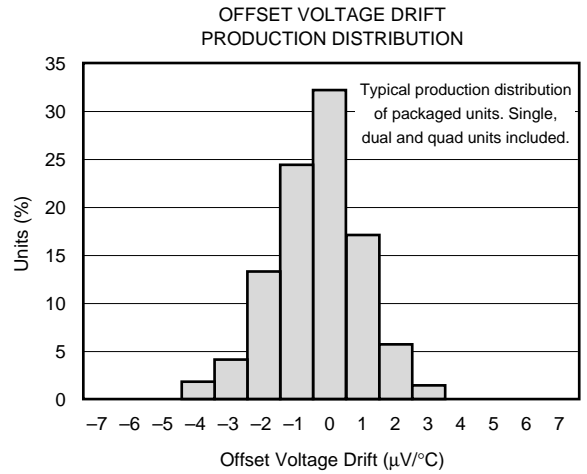
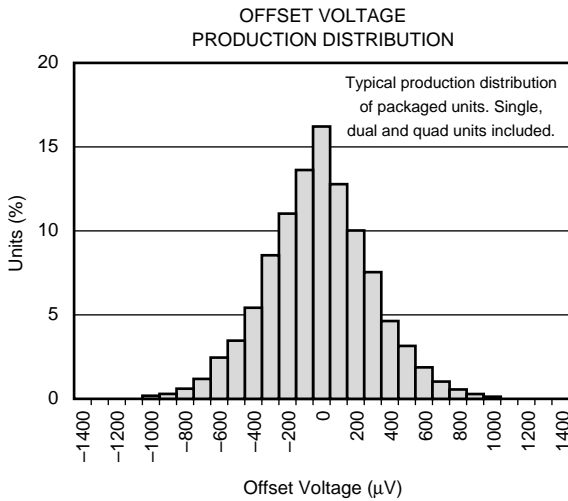
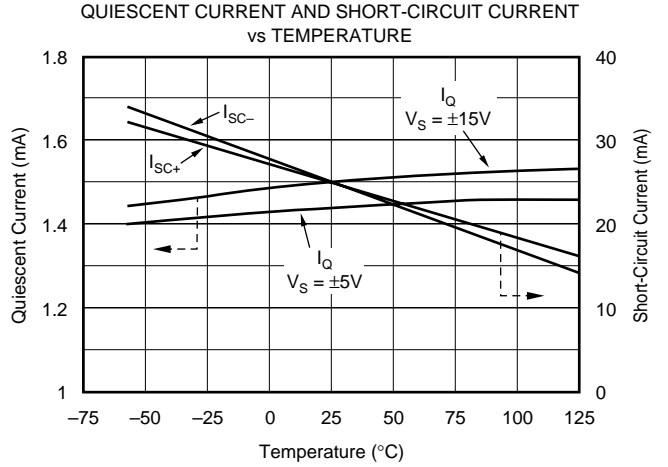
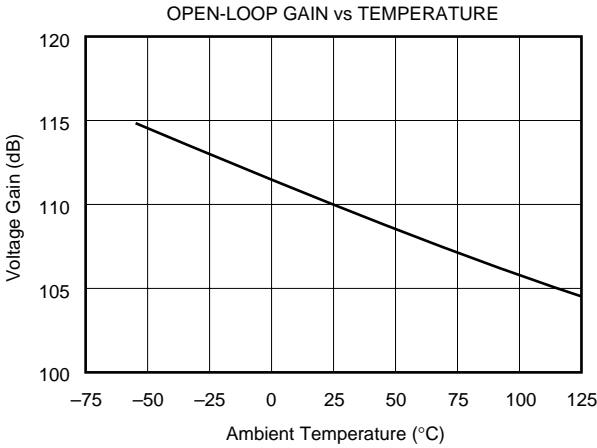

TYPICAL CHARACTERISTICS (Cont.)

At $T_{CASE} = +25^{\circ}C$, $V_S = \pm 15V$, and $R_L = 2k\Omega$, unless otherwise noted.

SMALL-SIGNAL STEP RESPONSE
 $G = 1$, $C_L = 300pF$

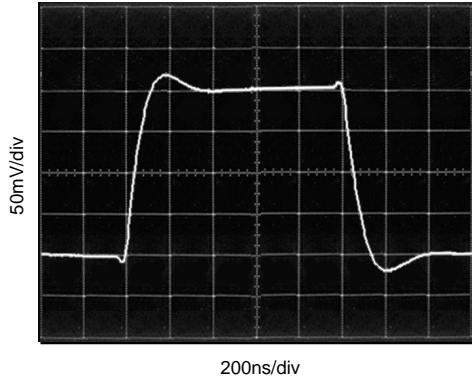

LARGE-SIGNAL STEP RESPONSE
 $G = 1$, $C_L = 300pF$

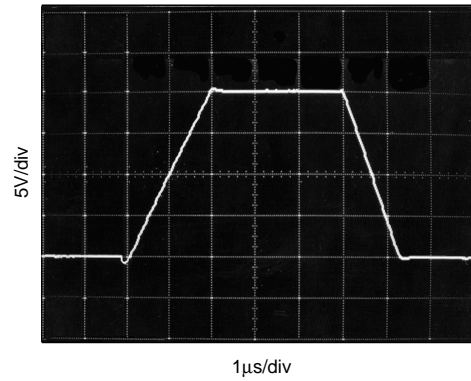

SETTLING TIME vs CLOSED-LOOP GAIN

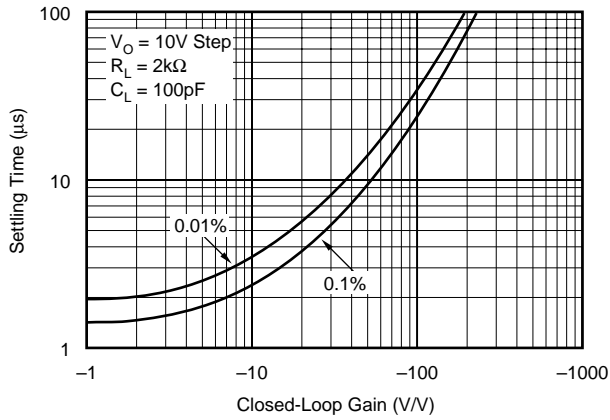

SMALL-SIGNAL OVERSHOOT vs LOAD CAPACITANCE

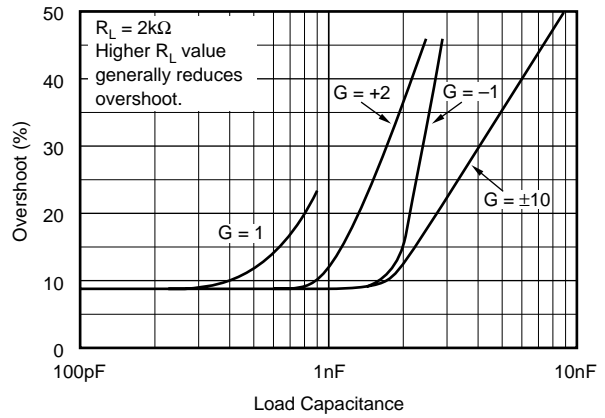

OUTPUT VOLTAGE SWING vs OUTPUT CURRENT

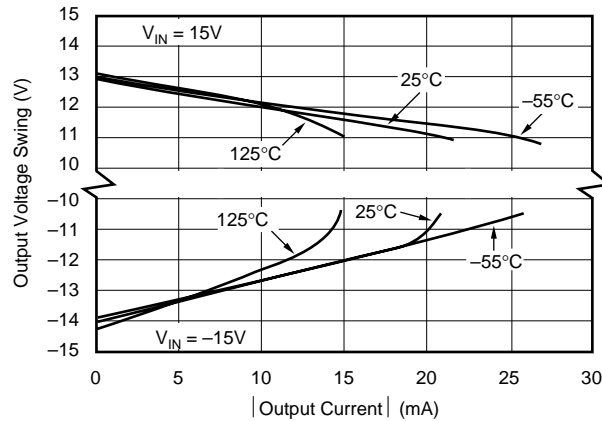

APPLICATIONS INFORMATION

The OPA131 series op amps are unity-gain stable and suitable for a wide range of general-purpose applications. Power-supply pins should be bypassed with 10nF ceramic capacitors or larger.

The OPA131 series op amps are free from unexpected output phase-reversal common with FET op amps. Many FET-input op amps exhibit phase-reversal of the output when the input common-mode voltage range is exceeded. This can occur in voltage-follower circuits, causing serious problems in control-loop applications. All circuitry is completely independent in dual and quad versions, assuring normal behavior when one amplifier in a package is overdriven or short-circuited.

OFFSET VOLTAGE TRIM

The OPA131 (single op amp version) provides offset voltage trim connections on pins 1 and 5. Offset voltage can be adjusted by connecting a potentiometer as shown in Figure 1. This adjustment should be used only to null the offset of the op amp, not system offset or offset produced by the signal source.

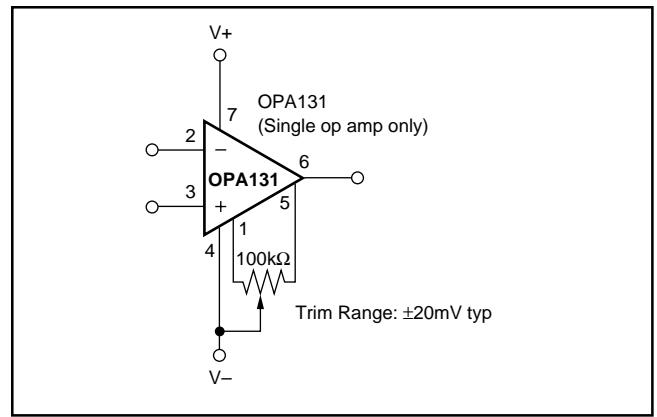

FIGURE 1. OPA131 Offset Voltage Trim Circuit.

INPUT BIAS CURRENT

The input bias current is approximately 5pA at room temperature and increases with temperature as shown in the typical characteristic "Input Bias Current vs Temperature."

Input bias current also varies with common-mode voltage and power supply voltage. This variation is dependent on the voltage between the negative power supply and the common-mode input voltage. The effect is shown in the typical curve "Input Bias Current vs Common-Mode Voltage."

PACKAGING INFORMATION

Orderable Device	Status (1)	Package Type	Package Drawing	Pins	Package Qty	Eco Plan (2)	Lead finish/ Ball material (6)	MSL Peak Temp (3)	Op Temp (°C)	Device Marking (4/5)	Samples
OPA131U	ACTIVE	SOIC	D	8	75	RoHS & Green	Call TI	Level-3-260C-168 HR	-55 to 125	OPA 131U	Samples
OPA131UA	ACTIVE	SOIC	D	8	75	RoHS & Green	Call TI	Level-3-260C-168 HR	-55 to 125	OPA 131U A	Samples
OPA131UA/2K5	ACTIVE	SOIC	D	8	2500	RoHS & Green	Call TI	Level-3-260C-168 HR	-55 to 125	OPA 131U A	Samples
OPA131UJ	ACTIVE	SOIC	D	8	75	RoHS & Green	NIPDAU-DCC	Level-3-260C-168 HR	-55 to 125	OPA 131UJ	Samples
OPA131UJ/2K5	ACTIVE	SOIC	D	8	2500	RoHS & Green	NIPDAU	Level-3-260C-168 HR	-55 to 125	OPA 131UJ	Samples
OPA2131UA	ACTIVE	SOIC	D	8	75	RoHS & Green	NIPDAU-DCC	Level-3-260C-168 HR	-55 to 125	OPA 2131UA	Samples
OPA2131UA/2K5	ACTIVE	SOIC	D	8	2500	RoHS & Green	NIPDAU	Level-3-260C-168 HR	-55 to 125	OPA 2131UA	Samples
OPA2131UA/2K5G4	LIFEBUY	SOIC	D	8	2500	RoHS & Green	NIPDAU	Level-3-260C-168 HR	-55 to 125	OPA 2131UA	
OPA2131UAE4	LIFEBUY	SOIC	D	8	75	RoHS & Green	NIPDAU-DCC	Level-3-260C-168 HR	-55 to 125	OPA 2131UA	
OPA2131UAG4	LIFEBUY	SOIC	D	8	75	RoHS & Green	NIPDAU-DCC	Level-3-260C-168 HR	-55 to 125	OPA 2131UA	
OPA2131UJ	ACTIVE	SOIC	D	8	75	RoHS & Green	NIPDAU-DCC	Level-3-260C-168 HR		OPA 2131UJ	Samples
OPA2131UJ/2K5	ACTIVE	SOIC	D	8	2500	RoHS & Green	NIPDAU	Level-3-260C-168 HR		OPA 2131UJ	Samples
OPA4131NA	ACTIVE	SOIC	D	14	50	RoHS & Green	NIPDAU-DCC	Level-3-260C-168 HR	-40 to 85	OPA4131NA	Samples
OPA4131NAG4	LIFEBUY	SOIC	D	14	50	RoHS & Green	NIPDAU-DCC	Level-3-260C-168 HR	-40 to 85	OPA4131NA	
OPA4131NJ	ACTIVE	SOIC	D	14	50	RoHS & Green	NIPDAU-DCC	Level-3-260C-168 HR	-40 to 85	OPA4131NJ	Samples
OPA4131PA	ACTIVE	PDIP	N	14	25	RoHS & Green	NIPDAU	N / A for Pkg Type	-40 to 85	OPA4131PA	Samples
OPA4131PAG4	ACTIVE	PDIP	N	14	25	RoHS & Green	NIPDAU	N / A for Pkg Type	-40 to 85	OPA4131PA	Samples

Orderable Device	Status (1)	Package Type	Package Drawing	Pins	Package Qty	Eco Plan (2)	Lead finish/ Ball material (6)	MSL Peak Temp (3)	Op Temp (°C)	Device Marking (4/5)	Samples
OPA4131PJ	ACTIVE	PDIP	N	14	25	RoHS & Green	NIPDAU	N / A for Pkg Type	-40 to 85	OPA4131PJ	Samples
OPA4131UA	ACTIVE	SOIC	DW	16	40	RoHS & Green	NIPDAU-DCC	Level-3-260C-168 HR	-40 to 85	OPA4131UA	Samples
OPA4131UA/1K	ACTIVE	SOIC	DW	16	1000	RoHS & Green	NIPDAU-DCC	Level-3-260C-168 HR	-40 to 85	OPA4131UA	Samples

(1) The marketing status values are defined as follows:

ACTIVE: Product device recommended for new designs.

LIFEBUY: TI has announced that the device will be discontinued, and a lifetime-buy period is in effect.

NRND: Not recommended for new designs. Device is in production to support existing customers, but TI does not recommend using this part in a new design.

PREVIEW: Device has been announced but is not in production. Samples may or may not be available.

OBSELETE: TI has discontinued the production of the device.

(2) **RoHS:** TI defines "RoHS" to mean semiconductor products that are compliant with the current EU RoHS requirements for all 10 RoHS substances, including the requirement that RoHS substance do not exceed 0.1% by weight in homogeneous materials. Where designed to be soldered at high temperatures, "RoHS" products are suitable for use in specified lead-free processes. TI may reference these types of products as "Pb-Free".

RoHS Exempt: TI defines "RoHS Exempt" to mean products that contain lead but are compliant with EU RoHS pursuant to a specific EU RoHS exemption.

Green: TI defines "Green" to mean the content of Chlorine (Cl) and Bromine (Br) based flame retardants meet JS709B low halogen requirements of <=1000ppm threshold. Antimony trioxide based flame retardants must also meet the <=1000ppm threshold requirement.

(3) MSL, Peak Temp. - The Moisture Sensitivity Level rating according to the JEDEC industry standard classifications, and peak solder temperature.

(4) There may be additional marking, which relates to the logo, the lot trace code information, or the environmental category on the device.

(5) Multiple Device Markings will be inside parentheses. Only one Device Marking contained in parentheses and separated by a "-" will appear on a device. If a line is indented then it is a continuation of the previous line and the two combined represent the entire Device Marking for that device.

(6) Lead finish/Ball material - Orderable Devices may have multiple material finish options. Finish options are separated by a vertical ruled line. Lead finish/Ball material values may wrap to two lines if the finish value exceeds the maximum column width.

Important Information and Disclaimer:The information provided on this page represents TI's knowledge and belief as of the date that it is provided. TI bases its knowledge and belief on information provided by third parties, and makes no representation or warranty as to the accuracy of such information. Efforts are underway to better integrate information from third parties. TI has taken and continues to take reasonable steps to provide representative and accurate information but may not have conducted destructive testing or chemical analysis on incoming materials and chemicals. TI and TI suppliers consider certain information to be proprietary, and thus CAS numbers and other limited information may not be available for release.

In no event shall TI's liability arising out of such information exceed the total purchase price of the TI part(s) at issue in this document sold by TI to Customer on an annual basis.

TAPE AND REEL INFORMATION

QUADRANT ASSIGNMENTS FOR PIN 1 ORIENTATION IN TAPE

*All dimensions are nominal

Device	Package Type	Package Drawing	Pins	SPQ	Reel Diameter (mm)	Reel Width W1 (mm)	A0 (mm)	B0 (mm)	K0 (mm)	P1 (mm)	W (mm)	Pin1 Quadrant
OPA131UA/2K5	SOIC	D	8	2500	330.0	12.4	6.4	5.2	2.1	8.0	12.0	Q1
OPA131UJ/2K5	SOIC	D	8	2500	330.0	12.4	6.4	5.2	2.1	8.0	12.0	Q1
OPA2131UA/2K5	SOIC	D	8	2500	330.0	12.4	6.4	5.2	2.1	8.0	12.0	Q1
OPA2131UJ/2K5	SOIC	D	8	2500	330.0	12.4	6.4	5.2	2.1	8.0	12.0	Q1
OPA4131UA/1K	SOIC	DW	16	1000	330.0	16.4	10.75	10.7	2.7	12.0	16.0	Q1

TAPE AND REEL BOX DIMENSIONS

*All dimensions are nominal

Device	Package Type	Package Drawing	Pins	SPQ	Length (mm)	Width (mm)	Height (mm)
OPA131UA/2K5	SOIC	D	8	2500	356.0	356.0	35.0
OPA131UJ/2K5	SOIC	D	8	2500	356.0	356.0	35.0
OPA2131UA/2K5	SOIC	D	8	2500	356.0	356.0	35.0
OPA2131UJ/2K5	SOIC	D	8	2500	356.0	356.0	35.0
OPA4131UA/1K	SOIC	DW	16	1000	356.0	356.0	35.0

TUBE

*All dimensions are nominal

Device	Package Name	Package Type	Pins	SPQ	L (mm)	W (mm)	T (μm)	B (mm)
OPA131U	D	SOIC	8	75	506.6	8	3940	4.32
OPA131UA	D	SOIC	8	75	506.6	8	3940	4.32
OPA131UJ	D	SOIC	8	75	506.6	8	3940	4.32
OPA2131UA	D	SOIC	8	75	506.6	8	3940	4.32
OPA2131UAE4	D	SOIC	8	75	506.6	8	3940	4.32
OPA2131UAG4	D	SOIC	8	75	506.6	8	3940	4.32
OPA2131UJ	D	SOIC	8	75	506.6	8	3940	4.32
OPA4131NA	D	SOIC	14	50	506.6	8	3940	4.32
OPA4131NAG4	D	SOIC	14	50	506.6	8	3940	4.32
OPA4131NJ	D	SOIC	14	50	506.6	8	3940	4.32
OPA4131PA	N	PDIP	14	25	506	13.97	11230	4.32
OPA4131PAG4	N	PDIP	14	25	506	13.97	11230	4.32
OPA4131PJ	N	PDIP	14	25	506	13.97	11230	4.32
OPA4131UA	DW	SOIC	16	40	507	12.83	5080	6.6

GENERIC PACKAGE VIEW

DW 16

SOIC - 2.65 mm max height

7.5 x 10.3, 1.27 mm pitch

SMALL OUTLINE INTEGRATED CIRCUIT

This image is a representation of the package family, actual package may vary.
Refer to the product data sheet for package details.



4224780/A



DW0016A

PACKAGE OUTLINE SOIC - 2.65 mm max height

SOIC

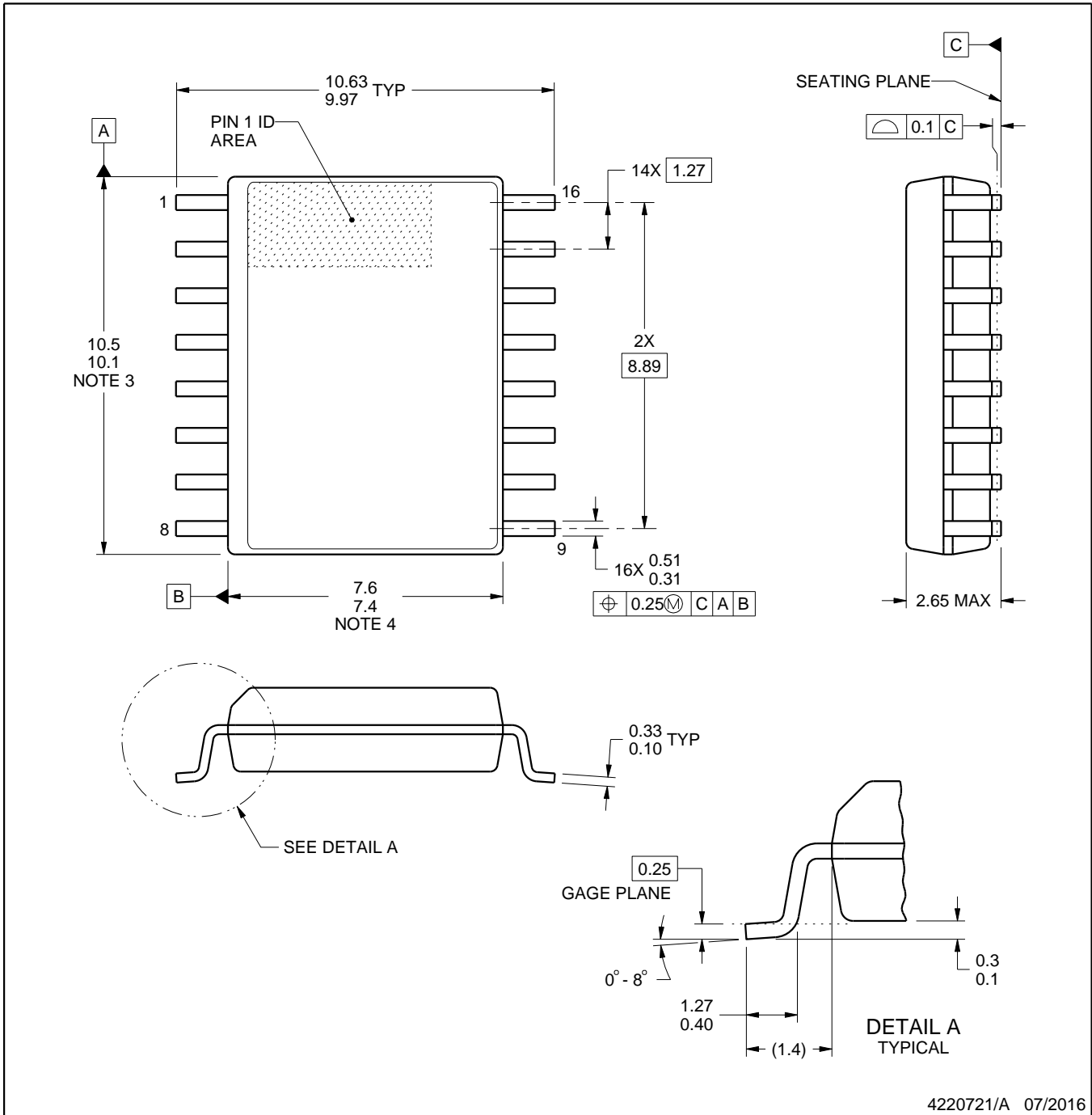

4220721/A 07/2016

NOTES:

1. All linear dimensions are in millimeters. Dimensions in parenthesis are for reference only. Dimensioning and tolerancing per ASME Y14.5M.
2. This drawing is subject to change without notice.
3. This dimension does not include mold flash, protrusions, or gate burrs. Mold flash, protrusions, or gate burrs shall not exceed 0.15 mm, per side.
4. This dimension does not include interlead flash. Interlead flash shall not exceed 0.25 mm, per side.
5. Reference JEDEC registration MS-013.

EXAMPLE BOARD LAYOUT

DW0016A

SOIC - 2.65 mm max height

SOIC



LAND PATTERN EXAMPLE
SCALE:7X



SOLDER MASK DETAILS

4220721/A 07/2016

NOTES: (continued)

6. Publication IPC-7351 may have alternate designs.

7. Solder mask tolerances between and around signal pads can vary based on board fabrication site.

EXAMPLE STENCIL DESIGN

DW0016A

SOIC - 2.65 mm max height

SOIC



SOLDER PASTE EXAMPLE
BASED ON 0.125 mm THICK STENCIL
SCALE:7X

4220721/A 07/2016

NOTES: (continued)

8. Laser cutting apertures with trapezoidal walls and rounded corners may offer better paste release. IPC-7525 may have alternate design recommendations.
9. Board assembly site may have different recommendations for stencil design.

D (R-PDSO-G14)

PLASTIC SMALL OUTLINE

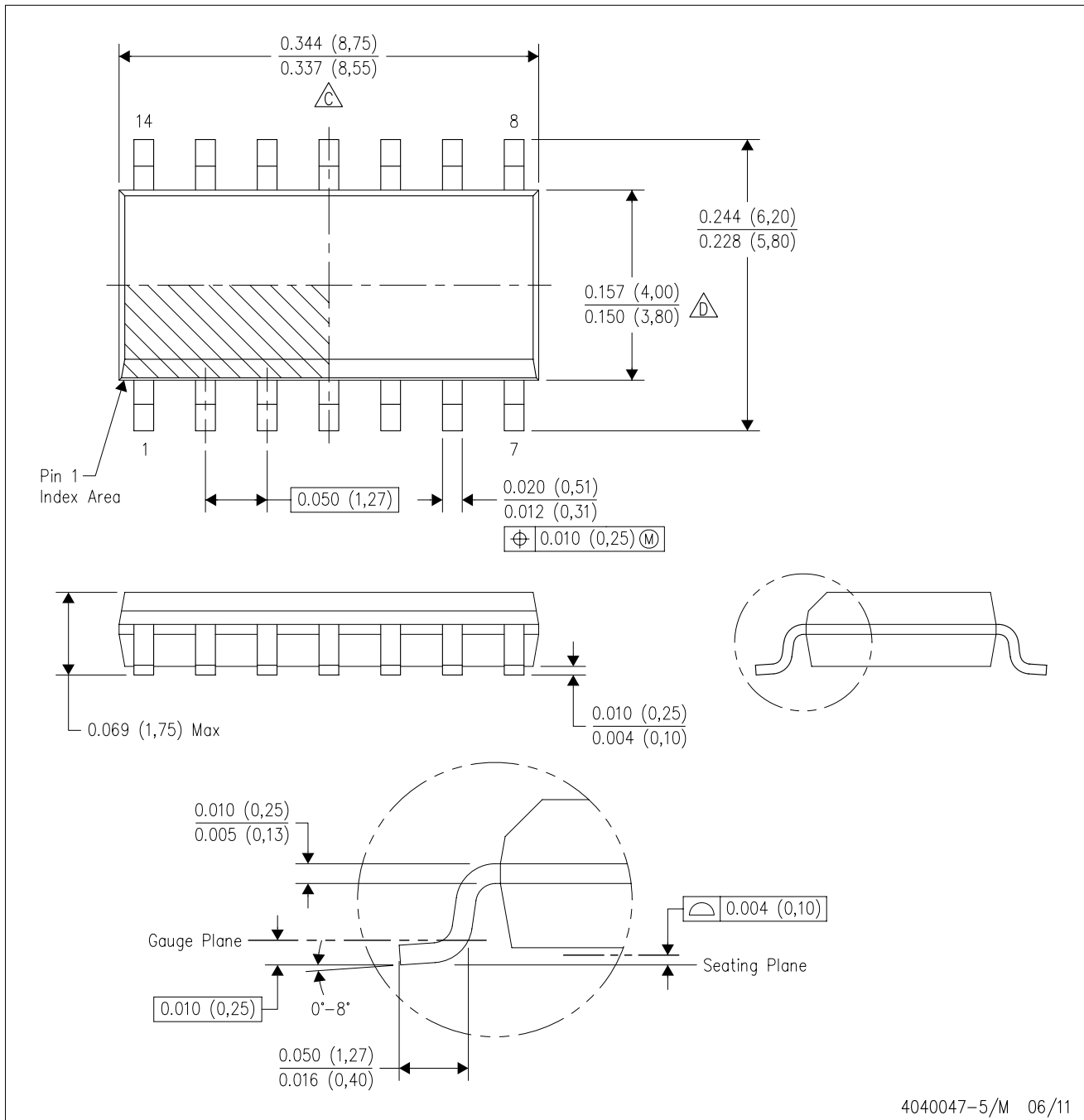

- NOTES:
- A. All linear dimensions are in inches (millimeters).
 - B. This drawing is subject to change without notice.
 - Body length does not include mold flash, protrusions, or gate burrs. Mold flash, protrusions, or gate burrs shall not exceed 0.006 (0,15) each side.
 - Body width does not include interlead flash. Interlead flash shall not exceed 0.017 (0,43) each side.
 - E. Reference JEDEC MS-012 variation AB.

D (R-PDSO-G14)

PLASTIC SMALL OUTLINE



- NOTES:
- All linear dimensions are in millimeters.
 - This drawing is subject to change without notice.
 - Publication IPC-7351 is recommended for alternate designs.
 - Laser cutting apertures with trapezoidal walls and also rounding corners will offer better paste release. Customers should contact their board assembly site for stencil design recommendations. Refer to IPC-7525 for other stencil recommendations.
 - Customers should contact their board fabrication site for solder mask tolerances between and around signal pads.



D0008A

PACKAGE OUTLINE

SOIC - 1.75 mm max height

SMALL OUTLINE INTEGRATED CIRCUIT



4214825/C 02/2019

NOTES:

1. Linear dimensions are in inches [millimeters]. Dimensions in parenthesis are for reference only. Controlling dimensions are in inches. Dimensioning and tolerancing per ASME Y14.5M.
2. This drawing is subject to change without notice.
3. This dimension does not include mold flash, protrusions, or gate burrs. Mold flash, protrusions, or gate burrs shall not exceed $.006$ [0.15] per side.
4. This dimension does not include interlead flash.
5. Reference JEDEC registration MS-012, variation AA.

EXAMPLE BOARD LAYOUT

D0008A

SOIC - 1.75 mm max height

SMALL OUTLINE INTEGRATED CIRCUIT



LAND PATTERN EXAMPLE
 EXPOSED METAL SHOWN
 SCALE:8X



SOLDER MASK DETAILS

4214825/C 02/2019

NOTES: (continued)

- 6. Publication IPC-7351 may have alternate designs.
- 7. Solder mask tolerances between and around signal pads can vary based on board fabrication site.

EXAMPLE STENCIL DESIGN

D0008A

SOIC - 1.75 mm max height

SMALL OUTLINE INTEGRATED CIRCUIT



SOLDER PASTE EXAMPLE
BASED ON .005 INCH [0.125 MM] THICK STENCIL
SCALE:8X

4214825/C 02/2019

NOTES: (continued)

8. Laser cutting apertures with trapezoidal walls and rounded corners may offer better paste release. IPC-7525 may have alternate design recommendations.
9. Board assembly site may have different recommendations for stencil design.

N (R-PDIP-T**)

PLASTIC DUAL-IN-LINE PACKAGE

16 PINS SHOWN



- NOTES:
- A. All linear dimensions are in inches (millimeters).
 - B. This drawing is subject to change without notice.
 - Falls within JEDEC MS-001, except 18 and 20 pin minimum body length (Dim A).
 - The 20 pin end lead shoulder width is a vendor option, either half or full width.

IMPORTANT NOTICE AND DISCLAIMER

TI PROVIDES TECHNICAL AND RELIABILITY DATA (INCLUDING DATA SHEETS), DESIGN RESOURCES (INCLUDING REFERENCE DESIGNS), APPLICATION OR OTHER DESIGN ADVICE, WEB TOOLS, SAFETY INFORMATION, AND OTHER RESOURCES "AS IS" AND WITH ALL FAULTS, AND DISCLAIMS ALL WARRANTIES, EXPRESS AND IMPLIED, INCLUDING WITHOUT LIMITATION ANY IMPLIED WARRANTIES OF MERCHANTABILITY, FITNESS FOR A PARTICULAR PURPOSE OR NON-INFRINGEMENT OF THIRD PARTY INTELLECTUAL PROPERTY RIGHTS.

These resources are intended for skilled developers designing with TI products. You are solely responsible for (1) selecting the appropriate TI products for your application, (2) designing, validating and testing your application, and (3) ensuring your application meets applicable standards, and any other safety, security, regulatory or other requirements.

These resources are subject to change without notice. TI grants you permission to use these resources only for development of an application that uses the TI products described in the resource. Other reproduction and display of these resources is prohibited. No license is granted to any other TI intellectual property right or to any third party intellectual property right. TI disclaims responsibility for, and you will fully indemnify TI and its representatives against, any claims, damages, costs, losses, and liabilities arising out of your use of these resources.

TI's products are provided subject to [TI's Terms of Sale](#) or other applicable terms available either on [ti.com](https://www.ti.com) or provided in conjunction with such TI products. TI's provision of these resources does not expand or otherwise alter TI's applicable warranties or warranty disclaimers for TI products.

TI objects to and rejects any additional or different terms you may have proposed.

Mailing Address: Texas Instruments, Post Office Box 655303, Dallas, Texas 75265
Copyright © 2023, Texas Instruments Incorporated