

SN74LVC244A 具有三态输出的八路缓冲器或驱动器

1 特性

- 工作电压范围为 1.65V 至 3.6V
- 输入电压高达 5.5V
- 额定工作温度范围为 -40°C 至 +85°C 以及 -40°C 至 +125°C
- 3.3V 时 t_{pd} 最大值为 5.9ns
- V_{OLP} (输出接地反弹) 典型值小于 0.8V ($V_{CC} = 3.3V$ 、 $T_A = 25^\circ C$ 时)
- V_{OHV} (输出 V_{OH} 下冲) 典型值大于 2V ($V_{CC} = 3.3V$ 、 $T_A = 25^\circ C$ 时)
- 所有端口均支持混合模式信号运行 (5V 输入或输出电压, 具有 3.3V V_{CC})
- I_{off} 支持带电插入、局部关断模式和后驱动保护
- 可作为下行转换器, 将最高 5.5V 的输入电压下行 {26} 转换至 V_{CC} 电平
- 采用超小型逻辑 QFN 封装 (最大高度为 0.5mm)
- 闩锁性能超过 250mA, {29} 符合 JESD 17 规范
- ESD 保护性能超过 JESD 22 规范要求
 - 2000V 人体放电模型
 - 1000V 充电器件模型

2 应用

- 服务器
- 发光二极管 (LED) 显示屏
- 网络交换机
- 电信基础设施
- 电机驱动器
- I/O 扩展器

3 说明

这些八路总线缓冲器专为 1.65V 至 3.6V V_{CC} 工作电压设计。SN74LVC244A 器件旨在实现数据总线间的异步通信。

器件信息

| 器件型号 | 封装 ⁽¹⁾ | 封装尺寸 (标称值) |
|----------------|-------------------|------------------|
| SN74LVC244AN | PDIP (20) | 25.40mm × 6.35mm |
| SN74LVC244ANS | SO (20) | 12.60mm × 5.30mm |
| SN74LVC244ADB | SSOP (20) | 7.50mm × 5.30mm |
| SN74LVC244ADGV | TVSOP (20) | 5.00mm × 4.40mm |
| SN74LVC244ADW | SOIC (20) | 12.80mm × 7.50mm |
| SN74LVC244ARGY | VQFN (20) | 4.50mm × 3.50mm |
| SN74LVC244AZQN | BGA (20) | 3.00mm × 4.00mm |
| SN74LVC244APW | TSSOP (20) | 6.50mm × 4.40mm |
| SN74LVC244ARWP | X1QFN (20) | 2.50mm × 3.30mm |

(1) 如需了解所有可用封装, 请参阅数据表末尾的可订购产品附录。

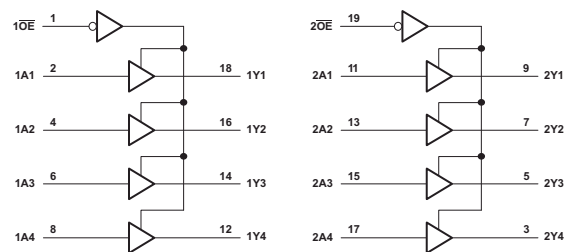

Pin numbers shown are for the DB, DGV, DW, N, NS, PW, and RGY packages.

逻辑图 (正逻辑)



Table of Contents

| | | | |
|--|----|--|----|
| 1 特性 | 1 | 8.3 Feature Description..... | 11 |
| 2 应用 | 1 | 8.4 Device Functional Modes..... | 11 |
| 3 说明 | 1 | 9 Application and Implementation | 12 |
| 4 Revision History | 2 | 9.1 Application Information..... | 12 |
| 5 Pin Configuration and Functions | 3 | 9.2 Typical Application..... | 12 |
| 6 Specifications | 5 | 10 Power Supply Recommendations | 13 |
| 6.1 Absolute Maximum Ratings..... | 5 | 11 Layout | 14 |
| 6.2 ESD Ratings..... | 5 | 11.1 Layout Guidelines..... | 14 |
| 6.3 Recommended Operating Conditions..... | 6 | 11.2 Layout Example..... | 14 |
| 6.4 Thermal Information..... | 6 | 12 Device and Documentation Support | 15 |
| 6.5 Electrical Characteristics..... | 7 | 12.1 Receiving Notification of Documentation Updates.. | 15 |
| 6.6 Switching Characteristics..... | 8 | 12.2 Support Resources..... | 15 |
| 6.7 Operating Characteristics..... | 8 | 12.3 Trademarks..... | 15 |
| 6.8 Typical Characteristics..... | 9 | 12.4 Electrostatic Discharge Caution..... | 15 |
| 7 Parameter Measurement Information | 10 | 12.5 Glossary..... | 15 |
| 8 Detailed Description | 11 | 13 Mechanical, Packaging, and Orderable Information | 15 |
| 8.1 Overview..... | 11 | | |
| 8.2 Functional Block Diagram..... | 11 | | |

4 Revision History

注：以前版本的页码可能与当前版本的页码不同

| Changes from Revision AB (November 2016) to Revision AC (October 2020) | Page |
|--|-------------|
| • 更新了整个文档的表、图和交叉参考的编号格式。..... | 1 |
| Changes from Revision AA (June 2016) to Revision AB (November 2016) | Page |
| • Changed A2 to A4 for 2 \overline{OE} in <i>Pin Functions</i> table..... | 3 |
| • Added ambient temperature, T_A for BGA package and all other packages in <i>Recommended Operating Conditions</i> | 6 |
| Changes from Revision Z (January 2015) to Revision AA (May 2016) | Page |
| • 更新了 <i>器件信息</i> 表以显示所有可用的封装..... | 1 |
| • Added RWP Package | 3 |
| • Deleted GQN package from <i>Pin Functions</i> table..... | 3 |
| • Added RWP thermal information to <i>Thermal Information</i> table and updated all thermal information for existing packages..... | 6 |
| • Updated all values for ZQN column in <i>Thermal Information</i> table..... | 6 |
| • Added package type in <i>Thermal Information</i> table..... | 6 |
| Changes from Revision Y (September 2010) to Revision Z (January 2015) | Page |
| • 添加了 <i>应用</i> 、 <i>器件信息</i> 表、 <i>引脚功能表</i> 、 <i>ESD</i> 等级表、 <i>热性能信息表</i> 、{11}典型特性{12}、{13}特性说明 {14} 部分、 <i>器件功能模式</i> 、 <i>应用和实施</i> 部分、 <i>电源建议</i> 部分、 <i>布局</i> 部分、 <i>器件和文档支持</i> 部分以及 <i>机械、封装和可订购信息</i> 部分。..... | 1 |
| • 删除了 <i>订购信息</i> 表，请参阅数据表末尾的 <i>机械、封装和可订购信息</i> | 1 |
| • 更新了 {31}特性{32}。..... | 1 |

5 Pin Configuration and Functions



图 5-1. ZQN Package 20-Pin BGA Top View



图 5-2. DB, DGV, DW, N, NS, and PW Packages 20-Pin SSOP, TVSOP, SOIC, PDIP, SO, and TSSOP Front View

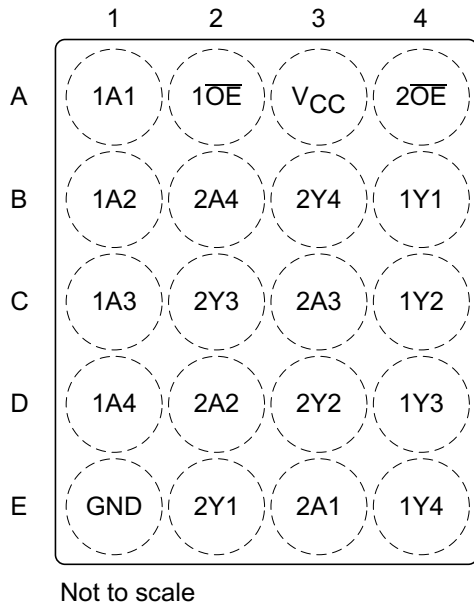

图 5-3. RGY Package 20-Pin VQFN Top View

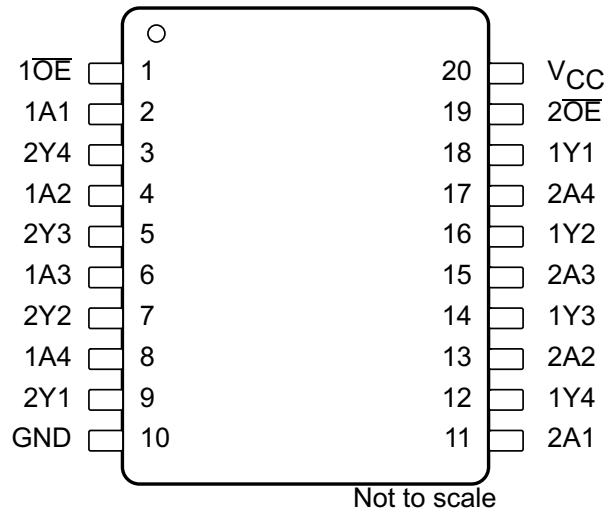

图 5-4. RWP Package 20-Pin X1QFN Top View

表 5-1. Pin Functions

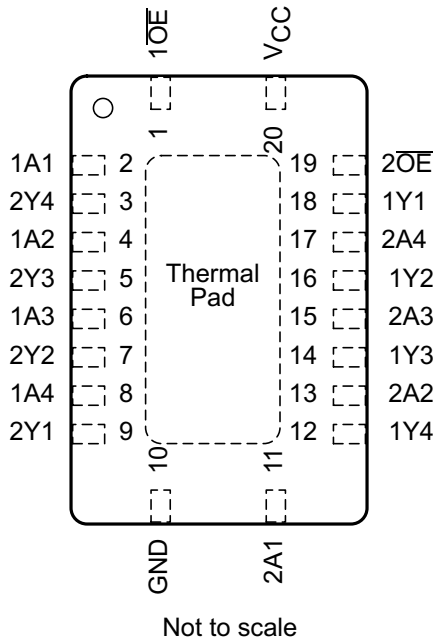
| NAME | PIN | | | TYPE | DESCRIPTION |
|-------------------|--|-----|-----|------|------------------|
| | DB, DGV, DW, N, NS, PW, and RGY | ZQN | RWP | | |
| 1A1 | 2 | A1 | 1 | I | Port 1 A1 input |
| 1A2 | 4 | B1 | 3 | I | Port 1 A2 input |
| 1A3 | 6 | C1 | 5 | I | Port 1 A3 input |
| 1A4 | 8 | D1 | 7 | I | Port 1 A4 input |
| 1 \overline{OE} | 1 | A2 | 20 | I | Output enable |
| 1Y1 | 18 | B4 | 17 | O | Port 1 Y1 output |
| 1Y2 | 16 | C4 | 15 | O | Port 1 Y2 output |
| 1Y3 | 14 | D4 | 13 | O | Port 1 Y3 output |
| 1Y4 | 12 | E4 | 11 | O | Port 1 Y4 output |
| 2A1 | 11 | E3 | 10 | I | Port 2 A1 input |
| 2A2 | 13 | D2 | 12 | I | Port 2 A2 input |
| 2A3 | 15 | C3 | 14 | I | Port 2 A3 input |
| 2A4 | 17 | B2 | 16 | I | Port 2 A4 input |
| 2 \overline{OE} | 19 | A4 | 18 | I | Output enable |
| 2Y1 | 9 | E2 | 8 | O | Port 2 Y1 output |
| 2Y2 | 7 | D3 | 6 | O | Port 2 Y2 output |
| 2Y3 | 5 | C2 | 4 | O | Port 2 Y3 output |
| 2Y4 | 3 | B3 | 2 | O | Port 2 Y4 output |
| GND | 10 | E1 | 9 | — | Ground |
| V _{CC} | 20 | A3 | 19 | — | Power pin |

6 Specifications

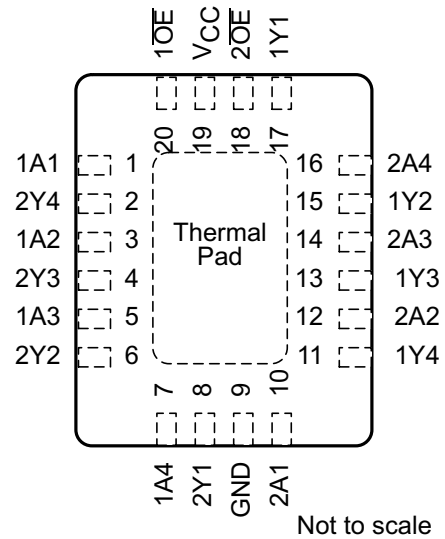
6.1 Absolute Maximum Ratings

over operating free-air temperature range (unless otherwise noted)⁽¹⁾

| | | | MIN | MAX | UNIT |
|------------------|---|--|-------|-----------------------|------|
| V _{CC} | Supply voltage | | - 0.5 | 6.5 | V |
| V _I | Input voltage ⁽²⁾ | | - 0.5 | 6.5 | V |
| V _O | Voltage range applied to any output in the high-impedance or power-off state ⁽²⁾ | | - 0.5 | 6.5 | V |
| V _O | Voltage range applied to any output in the high or low state ^{(2) (3)} | | - 0.5 | V _{CC} + 0.5 | V |
| I _{IK} | Input clamp current | V _I < 0 | | - 50 | mA |
| I _{OK} | Output clamp current | V _O < 0 | | - 50 | mA |
| I _O | Continuous output current | | | ±50 | mA |
| | Continuous current through V _{CC} or GND | | | ±100 | mA |
| P _{tot} | Power dissipation | T _A = - 40°C to +125°C ^{(4) (5)} | | 500 | mW |
| T _J | Junction temperature | | | 150 | °C |
| T _{stg} | Storage temperature | | - 65 | 150 | °C |

- (1) Stresses beyond those listed under *Absolute Maximum Ratings* may cause permanent damage to the device. These are stress ratings only, and functional operation of the device at these or any other conditions beyond those indicated under [¶ 6.3](#) is not implied. Exposure to absolute-maximum-rated conditions for extended periods may affect device reliability.
- (2) The input and output negative-voltage ratings may be exceeded if the input and output current ratings are observed.
- (3) The value of V_{CC} is provided in the [¶ 6.3](#) table.
- (4) For the DW package: above 70°C the value of P_{tot} derates linearly with 8 mW/K.
- (5) For the DB, DGV, N, NS, and PW packages: above 60°C the value of P_{tot} derates linearly with 5.5 mW/K.

6.2 ESD Ratings

| | | | VALUE | UNIT |
|--------------------|-------------------------|--|-------|------|
| V _(ESD) | Electrostatic discharge | Human-body model (HBM), per ANSI/ESDA/JEDEC JS-001 ⁽¹⁾ | ±2000 | V |
| | | Charged-device model (CDM), per JEDEC specification JESD22-C101 ⁽²⁾ | ±1000 | |

- (1) JEDEC document JEP155 states that 500-V HBM allows safe manufacturing with a standard ESD control process.
- (2) JEDEC document JEP157 states that 250-V CDM allows safe manufacturing with a standard ESD control process.

6.3 Recommended Operating Conditions

over recommended operating free-air temperature range (unless otherwise noted)⁽¹⁾

| | | T _A = 25°C | | - 40 TO +85°C | | - 40 TO +125°C | | UNIT | | |
|-----------------|---------------------------|------------------------------------|-----------------|------------------------|-----------------|------------------------|-----------------|------------------------|-----------------|----|
| | | MIN | MAX | MIN | MAX | MIN | MAX | | | |
| V _{CC} | Supply voltage | Operating | | 1.65 | 3.6 | 1.65 | 3.6 | 1.65 | 3.6 | V |
| | | Data retention only | | 1.5 | | 1.5 | | 1.5 | | |
| V _{IH} | High-level input voltage | V _{CC} = 1.65 V to 1.95 V | | 0.65 × V _{CC} | | 0.65 × V _{CC} | | 0.65 × V _{CC} | | V |
| | | V _{CC} = 2.3 V to 2.7 V | | 1.7 | | 1.7 | | 1.7 | | |
| | | V _{CC} = 2.7 V to 3.6 V | | 2 | | 2 | | 2 | | |
| V _{IL} | Low-level input voltage | V _{CC} = 1.65 V to 1.95 V | | 0.35 × V _{CC} | | 0.35 × V _{CC} | | 0.35 × V _{CC} | | V |
| | | V _{CC} = 2.3 V to 2.7 V | | 0.7 | | 0.7 | | 0.7 | | |
| | | V _{CC} = 2.7 V to 3.6 V | | 0.8 | | 0.8 | | 0.8 | | |
| V _I | Input voltage | 0 | 5.5 | 0 | 5.5 | 0 | 5.5 | 0 | 5.5 | V |
| V _O | Output voltage | 0 | V _{CC} | 0 | V _{CC} | 0 | V _{CC} | 0 | V _{CC} | V |
| I _{OH} | High-level output current | V _{CC} = 1.65 V | | - 4 | | - 4 | | - 4 | | mA |
| | | V _{CC} = 2.3 V | | - 8 | | - 8 | | - 8 | | |
| | | V _{CC} = 2.7 V | | - 12 | | - 12 | | - 12 | | |
| | | V _{CC} = 3 V | | - 24 | | - 24 | | - 24 | | |
| I _{OL} | Low-level output current | V _{CC} = 1.65 V | | 4 | | 4 | | 4 | | mA |
| | | V _{CC} = 2.3 V | | 8 | | 8 | | 8 | | |
| | | V _{CC} = 2.7 V | | 12 | | 12 | | 12 | | |
| | | V _{CC} = 3 V | | 24 | | 24 | | 24 | | |
| T _A | Ambient temperature | BGA package | | - 40 | | 85 | | | | °C |
| | | All other packages | | | | | | - 40 125 | | |

(1) All unused inputs of the device must be held at V_{CC} or GND to ensure proper device operation. See [Implications of Slow or Floating CMOS Inputs](#), SCBA004.

6.4 Thermal Information

| THERMAL METRIC ⁽¹⁾ | SN74LVC244A | | | | | | | | | | UNIT |
|-------------------------------|--|-------------------------------|-----------------------------|-----------------------------|----------------------------|---------------------------|------------------------------|------------------------------|-------------------------------|------|------|
| | DB ⁽²⁾ (SSOP) | DGV ⁽²⁾ (TVSOP) | DW ⁽²⁾ (SOIC) | ZQN ⁽²⁾ (BGA) | N ⁽²⁾ (PDIP) | NS ⁽²⁾ (SO) | PW ⁽²⁾ (TSSOP) | RGY ⁽³⁾ (VQFN) | RWP ⁽³⁾ (X1QFN) | | |
| | 20 PINS | | | | | | | | | | |
| R _{θJA} | Junction-to-ambient thermal resistance | 108.1 | 128.7 | 90.9 | 198.7 | 61.6 | 90.1 | 114.7 | 50.3 | 79.9 | °C/W |
| R _{θJC(top)} | Junction-to-case (top) thermal resistance | 70.2 | 43.7 | 55.3 | 106.8 | 46.5 | 56.4 | 48.4 | 58.4 | 63.2 | °C/W |
| R _{θJB} | Junction-to-board thermal resistance | 63.3 | 70.2 | 58.8 | 143.1 | 42.5 | 57.7 | 65.6 | 28.3 | 46.4 | °C/W |
| ψ _{JT} | Junction-to-top characterization parameter | 30.6 | 3.1 | 29.1 | 24.1 | 34.6 | 28.4 | 6.8 | 4.9 | 2.6 | °C/W |
| ψ _{JB} | Junction-to-board characterization parameter | 62.9 | 69.5 | 58.3 | 119.6 | 42.4 | 57.2 | 65.1 | 28.4 | 46.3 | °C/W |
| R _{θJC(bot)} | Junction-to-case (bottom) thermal resistance | — | — | — | n/a | — | — | — | 22.7 | 27.3 | °C/W |

(1) For more information about traditional and new thermal metrics, see the [Semiconductor and IC Package Thermal Metrics](#) application report.

(2) The package thermal impedance is calculated in accordance with JESD 51-7.

(3) The package thermal impedance is calculated in accordance with JESD 51-5.

6.5 Electrical Characteristics

over recommended operating free-air temperature range (unless otherwise noted)

| PARAMETER | TEST CONDITIONS | V _{CC} | T _A = 25°C | | | - 40 TO +85°C | | - 40 TO +125°C | | UNIT |
|---------------------------|---|-----------------------|-----------------------|-----|-----|-----------------------|-----|-----------------------|-----|------|
| | | | MIN | TYP | MAX | MIN | MAX | MIN | MAX | |
| V _{OH} | I _{OH} = - 100 μA | 1.65 V to 3.6 V | V _{CC} - 0.2 | | | V _{CC} - 0.2 | | V _{CC} - 0.3 | | V |
| | I _{OH} = - 4 mA | 1.65 V | 1.29 | | | 1.2 | | 1.05 | | |
| | I _{OH} = - 8 mA | 2.3 V | 1.9 | | | 1.7 | | 1.55 | | |
| | I _{OH} = - 12 mA | 2.7 V | 2.2 | | | 2.2 | | 2.05 | | |
| | | 3 V | 2.4 | | | 2.4 | | 2.25 | | |
| I _{OH} = - 24 mA | 3 V | 2.3 | | | 2.2 | | 2 | | | |
| V _{OL} | I _{OL} = 100 μA | 1.65 V to 3.6 V | 0.1 | | | 0.2 | | 0.3 | | V |
| | I _{OL} = 4 mA | 1.65 V | 0.24 | | | 0.45 | | 0.6 | | |
| | I _{OL} = 8 mA | 2.3 V | 0.3 | | | 0.7 | | 0.75 | | |
| | I _{OL} = 12 mA | 2.7 V | 0.4 | | | 0.4 | | 0.6 | | |
| | I _{OL} = 24 mA | 3 V | 0.55 | | | 0.55 | | 0.8 | | |
| I _I | V _I = 5.5 V or GND | 3.6 V | ±1 | | | ±5 | | ±20 | | μA |
| I _{off} | V _I or V _O = 5.5 V | 0 | ±1 | | | ±10 | | ±20 | | μA |
| I _{OZ} | V _O = 0 to 5.5 V | 3.6 V | ±1 | | | ±10 | | ±20 | | μA |
| I _{CC} | V _I = V _{CC} or GND | 3.6 V | 1 | | | 10 | | 40 | | μA |
| | 3.6 V ≤ V _I ≤ 5.5 V ⁽¹⁾ | | I _O = 0 | 1 | | | 10 | | 40 | |
| Δ I _{CC} | One input at V _{CC} - 0.6 V, Other inputs at V _{CC} or GND | 2.7 V to 3.6 V | 500 | | | 500 | | 5000 | | μA |
| C _i | V _I = V _{CC} or GND | 3.3 V | 4 | | | | | | | pF |
| C _o | V _O = V _{CC} or GND | 3.3 V | 5.5 | | | | | | | pF |

(1) This applies in the disabled state only.

6.6 Switching Characteristics

over recommended operating free-air temperature range (unless otherwise noted) (see [Figure 7-1](#))

| PARAMETER | FROM (INPUT) | TO (OUTPUT) | V _{CC} | T _A = 25°C | | | - 40 TO +85°C | | - 40 TO +125°C | | UNIT |
|--------------------|-----------------|----------------|-----------------|-----------------------|-----|------|---------------|------|----------------|------|------|
| | | | | MIN | TYP | MAX | MIN | MAX | MIN | MAX | |
| t _{pd} | A | Y | 1.5 V | 1 | 7 | 14.4 | 1 | 14.9 | 1 | 16.4 | ns |
| | | | 1.8 V ± 0.15 V | 1 | 5.9 | 10.4 | 1 | 10.9 | 1 | 12.4 | |
| | | | 2.5 V ± 0.2 V | 1 | 4.2 | 7.4 | 1 | 7.9 | 1 | 10 | |
| | | | 2.7 V | 1 | 4.2 | 6.7 | 1 | 6.9 | 1 | 8.2 | |
| | | | 3.3 V ± 0.3 V | 1.5 | 3.9 | 5.7 | 1.5 | 5.9 | 1.5 | 7.2 | |
| t _{en} | OE | Y | 1.5 V | 1 | 8.3 | 17.8 | 1 | 18.3 | 1 | 19.8 | ns |
| | | | 1.8 V ± 0.15 V | 1 | 6.4 | 12.1 | 1 | 12.6 | 1 | 14.1 | |
| | | | 2.5 V ± 0.2 V | 1 | 4.6 | 9.1 | 1 | 9.6 | 1 | 11.7 | |
| | | | 2.7 V | 1 | 5 | 8.4 | 1 | 8.6 | 1 | 10.3 | |
| | | | 3.3 V ± 0.3 V | 1.5 | 4.5 | 7.4 | 1.5 | 7.6 | 1.5 | 9.4 | |
| t _{dis} | OE | Y | 1.5 V | 1 | 7.2 | 15.6 | 1 | 16.1 | 1 | 17.6 | ns |
| | | | 1.8 V ± 0.15 V | 1 | 5.8 | 11.6 | 1 | 12.1 | 1 | 13.6 | |
| | | | 2.5 V ± 0.2 V | 1 | 3.7 | 7.3 | 1 | 7.8 | 1 | 9.9 | |
| | | | 2.7 V | 1 | 3.8 | 6.6 | 1 | 6.8 | 1 | 8.6 | |
| | | | 3.3 V ± 0.3 V | 1.5 | 3.8 | 6.3 | 1.5 | 6.5 | 1.5 | 8 | |
| t _{sk(o)} | | | 3.3 V ± 0.3 V | | | | 1 | 1.5 | ns | | |

6.7 Operating Characteristics

T_A = 25°C

| PARAMETER | | TEST CONDITIONS | V _{CC} | TYP | UNIT | |
|-----------------|---|------------------|-----------------|-------|------|----|
| C _{pd} | Power dissipation capacitance per buffer/driver | Outputs enabled | f = 10 MHz | 1.8 V | 43 | pF |
| | | | | 2.5 V | 43 | |
| | | | | 3.3 V | 44 | |
| | | Outputs disabled | f = 10 MHz | 1.8 V | 1 | |
| | | | | 2.5 V | 1 | |
| | | | | 3.3 V | 2 | |

6.8 Typical Characteristics

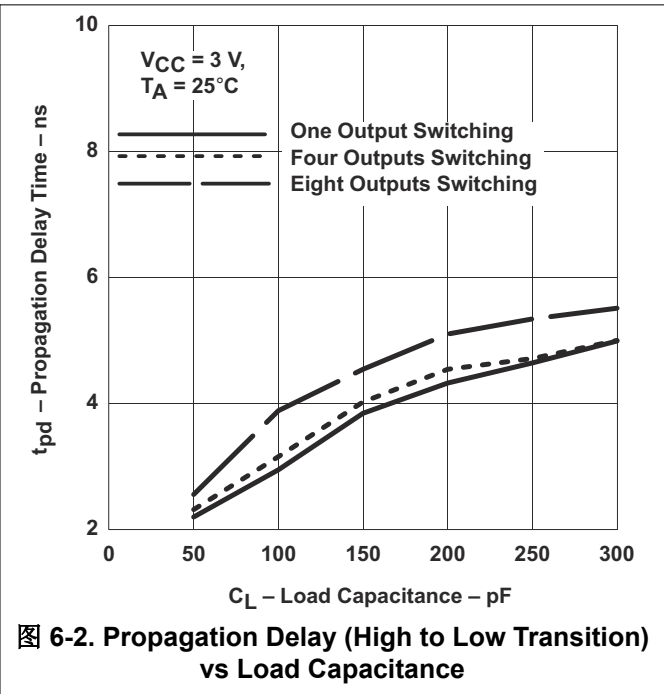
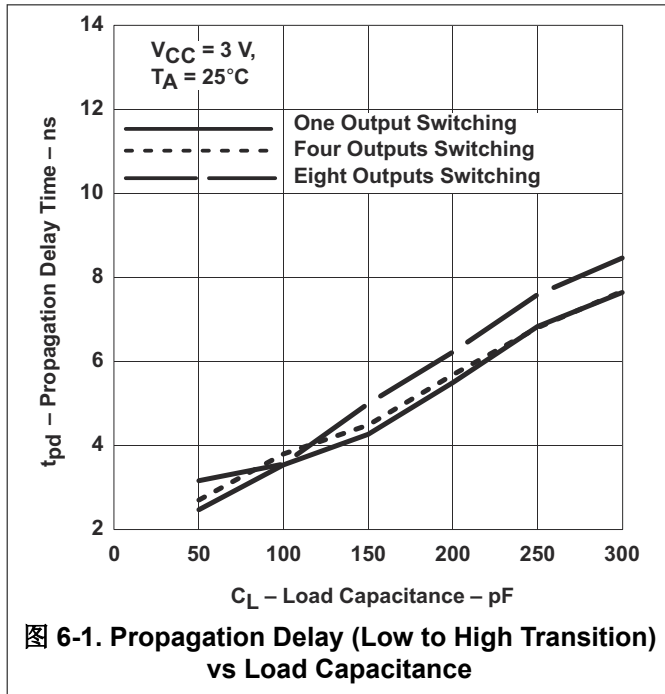

7 Parameter Measurement Information

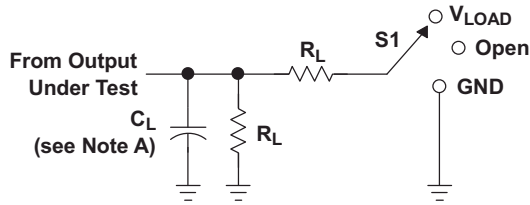

LOAD CIRCUIT

| TEST | S1 |
|-------------------|------------|
| t_{PLH}/t_{PHL} | Open |
| t_{PLZ}/t_{PZL} | V_{LOAD} |
| t_{PHZ}/t_{PZH} | GND |

| V_{CC} | INPUTS | | V_M | V_{LOAD} | C_L | R_L | V_{Δ} |
|------------------------------------|----------|---------------|------------|-------------------|-------|--------------|--------------|
| | V_I | t_r/t_f | | | | | |
| 1.5 V | V_{CC} | ≤ 2 ns | $V_{CC}/2$ | $2 \times V_{CC}$ | 15 pF | 2 k Ω | 0.1 V |
| $1.8 \text{ V} \pm 0.15 \text{ V}$ | V_{CC} | ≤ 2 ns | $V_{CC}/2$ | $2 \times V_{CC}$ | 30 pF | 1 k Ω | 0.15 V |
| $2.5 \text{ V} \pm 0.2 \text{ V}$ | V_{CC} | ≤ 2 ns | $V_{CC}/2$ | $2 \times V_{CC}$ | 30 pF | 500 Ω | 0.15 V |
| 2.7 V | 2.7 V | ≤ 2.5 ns | 1.5 V | 6 V | 50 pF | 500 Ω | 0.3 V |
| $3.3 \text{ V} \pm 0.3 \text{ V}$ | 2.7 V | ≤ 2.5 ns | 1.5 V | 6 V | 50 pF | 500 Ω | 0.3 V |

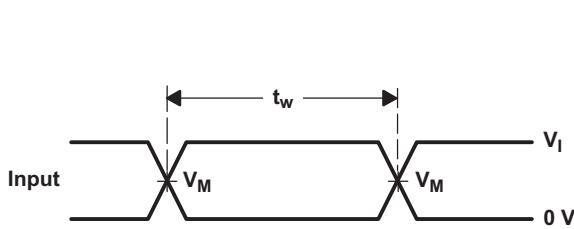

VOLTAGE WAVEFORMS PULSE DURATION

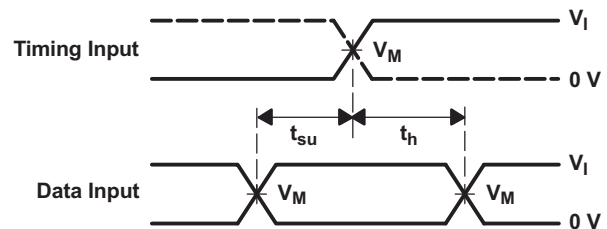

VOLTAGE WAVEFORMS SETUP AND HOLD TIMES

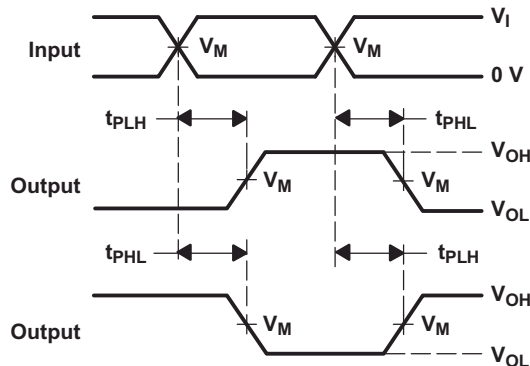

VOLTAGE WAVEFORMS PROPAGATION DELAY TIMES INVERTING AND NONINVERTING OUTPUTS

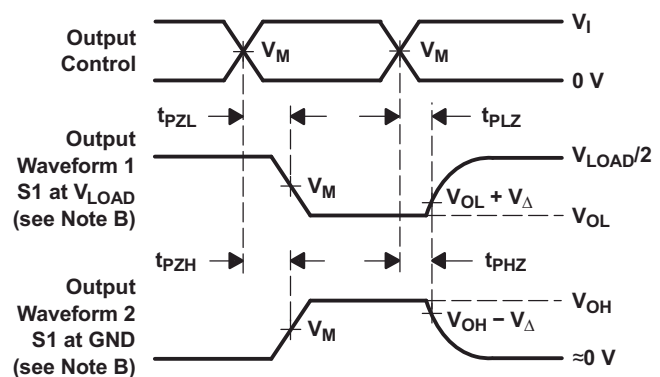

VOLTAGE WAVEFORMS ENABLE AND DISABLE TIMES LOW- AND HIGH-LEVEL ENABLING

- NOTES:
- A. C_L includes probe and jig capacitance.
 - B. Waveform 1 is for an output with internal conditions such that the output is low, except when disabled by the output control. Waveform 2 is for an output with internal conditions such that the output is high, except when disabled by the output control.
 - C. All input pulses are supplied by generators having the following characteristics: PRR ≤ 10 MHz, $Z_O = 50 \Omega$.
 - D. The outputs are measured one at a time, with one transition per measurement.
 - E. t_{PLZ} and t_{PHZ} are the same as t_{dis} .
 - F. t_{PZL} and t_{PZH} are the same as t_{en} .
 - G. t_{PLH} and t_{PHL} are the same as t_{pd} .
 - H. All parameters and waveforms are not applicable to all devices.

图 7-1. Load Circuit and Voltage Waveforms

8 Detailed Description

8.1 Overview

The SN74LVC244A device is organized as two 4-bit buffers/line drivers with separate output-enable (\overline{OE}) inputs. The device passes data from the A inputs to the Y outputs when \overline{OE} is low. The outputs are in the high-impedance state when \overline{OE} is high. \overline{OE} should be tied to V_{CC} through a pullup resistor to ensure the high-impedance state during power up or power down; the minimum value of the resistor is determined by the current-sinking capability of the driver.

8.2 Functional Block Diagram

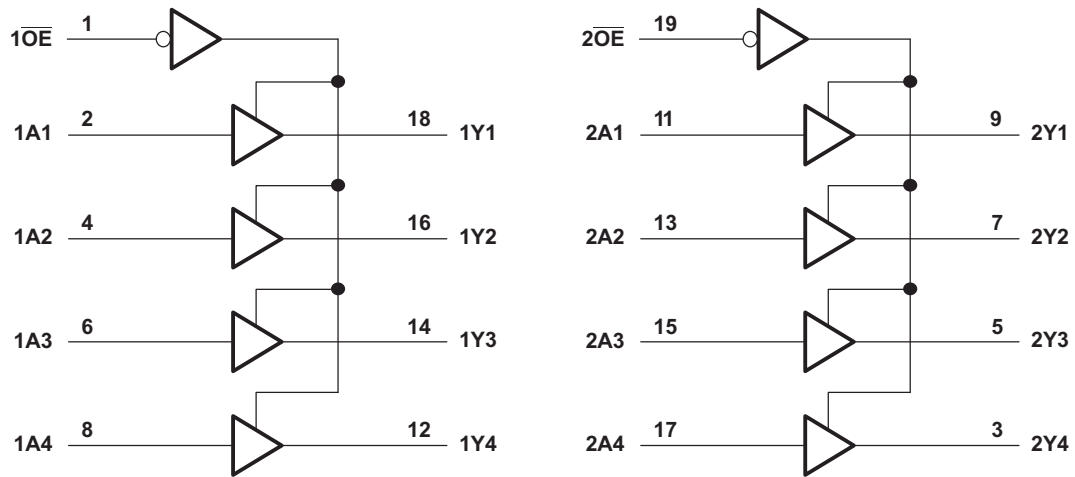

Pin numbers shown are for the DB, DGV, DW, N, NS, PW, and RGY packages.

图 8-1. Logic Diagram (Positive Logic)

8.3 Feature Description

- Allows down voltage translation
 - 5 V to 3.3 V
 - 5 V or 3.3 V to 1.8 V
- Inputs accept voltage levels up to 5.5 V
- It is available in ultra small logic 20 pin QFN package at 0.5 mm max height with 0.4 mm pitch.

8.4 Device Functional Modes

表 8-1 lists the functional modes of the SN74LVC244A.

表 8-1. Function Table

| INPUTS | | OUTPUT Y |
|--------|---|-------------|
| OE | A | |
| L | H | H |
| L | L | L |
| H | X | Hi-Z |

9 Application and Implementation

Note

Information in the following applications sections is not part of the TI component specification, and TI does not warrant its accuracy or completeness. TI's customers are responsible for determining suitability of components for their purposes. Customers should validate and test their design implementation to confirm system functionality.

9.1 Application Information

SN74LVC244A is a high drive CMOS device that can be used for a multitude of bus interface type applications where output drive or PCB trace length is a concern. The inputs can accept voltages to 5.5 V at any valid V_{CC} making it ideal for down translation.

9.2 Typical Application



图 9-1. Application Schematic

9.2.1 Design Requirements

This device uses CMOS technology and has balanced output drive. Avoid bus contention because it can drive currents in excess of maximum limits. The high drive will also create fast edges into light loads, so consider routing and load conditions to prevent ringing.

9.2.2 Detailed Design Procedure

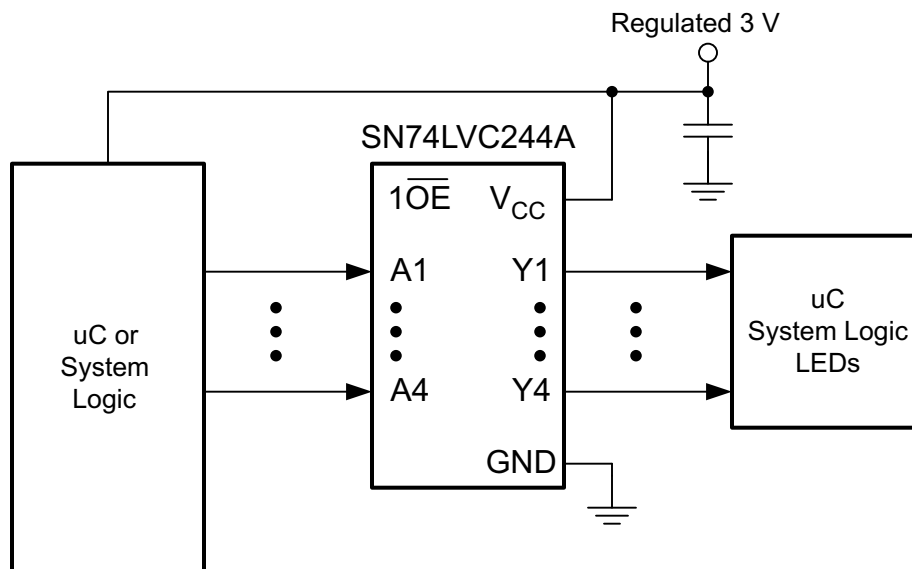
1. Recommended Input Conditions:

- For rise time and fall time specification, see $(\Delta t / \Delta V)$ in the § 6.3 table.
- For specified high and low levels, see $(V_{IH}$ and $V_{IL})$ in the § 6.3 table.
- Inputs are overvoltage tolerant allowing them to go as high as $(V_I \text{ max})$ in the § 6.3 table at any valid V_{CC} .

2. Recommended maximum Output Conditions:

- Load currents should not exceed $(I_O \text{ max})$ per output and should not exceed (Continuous current through V_{CC} or GND) total current for the part. These limits are located in the § 6.1 table.
- Outputs should not be pulled above V_{CC} .

9.2.3 Application Curves

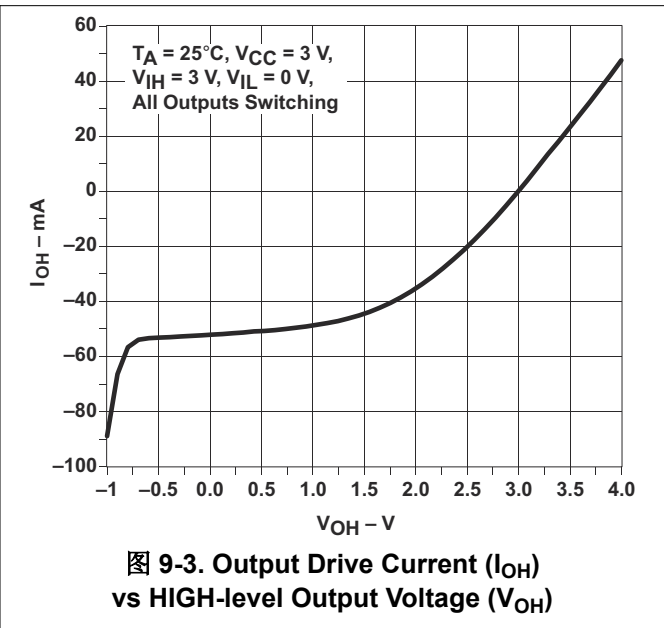
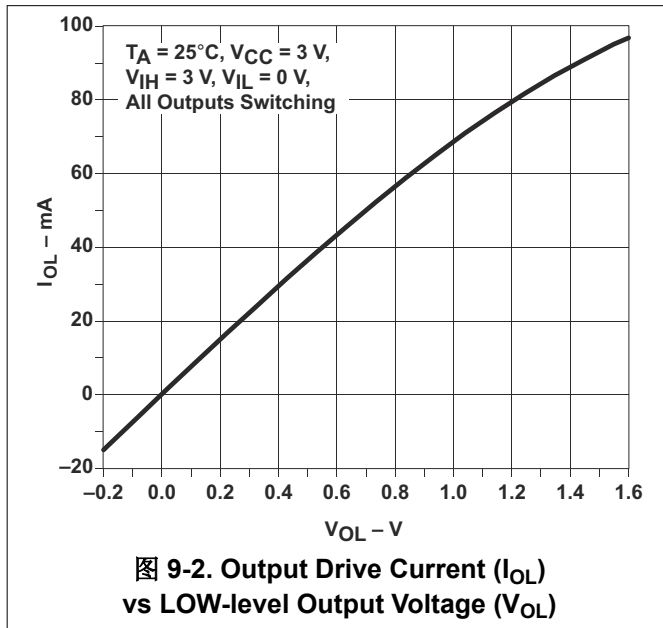

10 Power Supply Recommendations

The power supply may be any voltage between the MIN and MAX supply voltage rating located in the [表 6.3](#) table.

Each V_{CC} terminal should have a good bypass capacitor to prevent power disturbance. A $0.1\ \mu\text{F}$ capacitor is recommended for devices with a single supply. If there are multiple V_{CC} terminals, then $0.01\ \mu\text{F}$ or $0.022\ \mu\text{F}$ capacitors are recommended for each power terminal. It is permissible to parallel multiple bypass capacitors to reject different frequencies of noise. Multiple bypass capacitors may be paralleled to reject different frequencies of noise. The bypass capacitor should be installed as close to the power terminal as possible for the best results.

11 Layout

11.1 Layout Guidelines

Inputs should not float when using multiple bit logic devices. In many cases, functions or parts of functions of digital logic devices are unused. Some examples include situations when only two inputs of a triple-input AND gate are used, or when only 3 of the 4-buffer gates are used. Such input pins should not be left unconnected because the undefined voltages at the outside connections result in undefined operational states.

Specified in [图 11-1](#) are rules that must be observed under all circumstances. All unused inputs of digital logic devices must be connected to a high or low bias to prevent them from floating. The logic level that should be applied to any particular unused input depends on the function of the device. Generally, they will be tied to GND or V_{CC} , whichever makes more sense or is more convenient.

11.2 Layout Example



图 11-1. Layout Diagram

12 Device and Documentation Support

12.1 Receiving Notification of Documentation Updates

To receive notification of documentation updates, navigate to the device product folder on ti.com. Click on *Subscribe to updates* to register and receive a weekly digest of any product information that has changed. For change details, review the revision history included in any revised document.

12.2 Support Resources

[TI E2E™ support forums](#) are an engineer's go-to source for fast, verified answers and design help — straight from the experts. Search existing answers or ask your own question to get the quick design help you need.

Linked content is provided "AS IS" by the respective contributors. They do not constitute TI specifications and do not necessarily reflect TI's views; see TI's [Terms of Use](#).

12.3 Trademarks

TI E2E™ is a trademark of Texas Instruments.

所有商标均为其各自所有者的财产。

12.4 Electrostatic Discharge Caution



This integrated circuit can be damaged by ESD. Texas Instruments recommends that all integrated circuits be handled with appropriate precautions. Failure to observe proper handling and installation procedures can cause damage.

ESD damage can range from subtle performance degradation to complete device failure. Precision integrated circuits may be more susceptible to damage because very small parametric changes could cause the device not to meet its published specifications.

12.5 Glossary

[TI Glossary](#) This glossary lists and explains terms, acronyms, and definitions.

13 Mechanical, Packaging, and Orderable Information

The following pages include mechanical packaging and orderable information. This information is the most current data available for the designated devices. This data is subject to change without notice and revision of this document. For browser based versions of this data sheet, refer to the left hand navigation.

PACKAGING INFORMATION

| Orderable Device | Status (1) | Package Type | Package Drawing | Pins | Package Qty | Eco Plan (2) | Lead finish/ Ball material (6) | MSL Peak Temp (3) | Op Temp (°C) | Device Marking (4/5) | Samples |
|------------------|---------------|--------------|--------------------|------|----------------|---------------------|--------------------------------------|----------------------|--------------|-------------------------|-------------------------|
| SN74LVC244ADBR | ACTIVE | SSOP | DB | 20 | 2000 | RoHS & Green | NIPDAU | Level-1-260C-UNLIM | -40 to 125 | LC244A | Samples |
| SN74LVC244ADBRE4 | ACTIVE | SSOP | DB | 20 | 2000 | RoHS & Green | NIPDAU | Level-1-260C-UNLIM | -40 to 125 | LC244A | Samples |
| SN74LVC244ADBRG4 | ACTIVE | SSOP | DB | 20 | 2000 | RoHS & Green | NIPDAU | Level-1-260C-UNLIM | -40 to 125 | LC244A | Samples |
| SN74LVC244ADGVR | ACTIVE | TVSOP | DGV | 20 | 2000 | RoHS & Green | NIPDAU | Level-1-260C-UNLIM | -40 to 125 | LC244A | Samples |
| SN74LVC244ADW | ACTIVE | SOIC | DW | 20 | 25 | RoHS & Green | NIPDAU | Level-1-260C-UNLIM | -40 to 125 | LVC244A | Samples |
| SN74LVC244ADWE4 | ACTIVE | SOIC | DW | 20 | 25 | RoHS & Green | NIPDAU | Level-1-260C-UNLIM | -40 to 125 | LVC244A | Samples |
| SN74LVC244ADWG4 | ACTIVE | SOIC | DW | 20 | 25 | RoHS & Green | NIPDAU | Level-1-260C-UNLIM | -40 to 125 | LVC244A | Samples |
| SN74LVC244ADWR | ACTIVE | SOIC | DW | 20 | 2000 | RoHS & Green | NIPDAU SN | Level-1-260C-UNLIM | -40 to 125 | LVC244A | Samples |
| SN74LVC244ADWRG4 | ACTIVE | SOIC | DW | 20 | 2000 | RoHS & Green | NIPDAU | Level-1-260C-UNLIM | -40 to 125 | LVC244A | Samples |
| SN74LVC244AN | ACTIVE | PDIP | N | 20 | 20 | RoHS & Non-Green | NIPDAU | N / A for Pkg Type | -40 to 125 | SN74LVC244AN | Samples |
| SN74LVC244ANSR | ACTIVE | SO | NS | 20 | 2000 | RoHS & Green | NIPDAU | Level-1-260C-UNLIM | -40 to 125 | LVC244A | Samples |
| SN74LVC244APW | ACTIVE | TSSOP | PW | 20 | 70 | RoHS & Green | NIPDAU | Level-1-260C-UNLIM | -40 to 125 | LC244A | Samples |
| SN74LVC244APWE4 | ACTIVE | TSSOP | PW | 20 | 70 | RoHS & Green | NIPDAU | Level-1-260C-UNLIM | -40 to 125 | LC244A | Samples |
| SN74LVC244APWG4 | ACTIVE | TSSOP | PW | 20 | 70 | RoHS & Green | NIPDAU | Level-1-260C-UNLIM | -40 to 125 | LC244A | Samples |
| SN74LVC244APWR | ACTIVE | TSSOP | PW | 20 | 2000 | RoHS & Green | NIPDAU SN | Level-1-260C-UNLIM | -40 to 125 | LC244A | Samples |
| SN74LVC244APWRE4 | ACTIVE | TSSOP | PW | 20 | 2000 | RoHS & Green | NIPDAU | Level-1-260C-UNLIM | -40 to 125 | LC244A | Samples |
| SN74LVC244APWRG3 | ACTIVE | TSSOP | PW | 20 | 2000 | RoHS & Green | SN | Level-1-260C-UNLIM | -40 to 125 | LC244A | Samples |
| SN74LVC244APWRG4 | ACTIVE | TSSOP | PW | 20 | 2000 | RoHS & Green | NIPDAU | Level-1-260C-UNLIM | -40 to 125 | LC244A | Samples |
| SN74LVC244APWT | ACTIVE | TSSOP | PW | 20 | 250 | RoHS & Green | NIPDAU | Level-1-260C-UNLIM | -40 to 125 | LC244A | Samples |
| SN74LVC244APWTE4 | ACTIVE | TSSOP | PW | 20 | 250 | RoHS & Green | NIPDAU | Level-1-260C-UNLIM | -40 to 125 | LC244A | Samples |

| Orderable Device | Status (1) | Package Type | Package Drawing | Pins | Package Qty | Eco Plan (2) | Lead finish/ Ball material (6) | MSL Peak Temp (3) | Op Temp (°C) | Device Marking (4/5) | Samples |
|-------------------|---------------|--------------|-----------------|------|-------------|-----------------|--------------------------------------|----------------------|--------------|-------------------------|-------------------------|
| SN74LVC244APWTG4 | ACTIVE | TSSOP | PW | 20 | 250 | RoHS & Green | NIPDAU | Level-1-260C-UNLIM | -40 to 125 | LC244A | Samples |
| SN74LVC244ARGYR | ACTIVE | VQFN | RGY | 20 | 3000 | RoHS & Green | NIPDAU | Level-2-260C-1 YEAR | -40 to 125 | LC244A | Samples |
| SN74LVC244ARGYRG4 | ACTIVE | VQFN | RGY | 20 | 3000 | RoHS & Green | NIPDAU | Level-2-260C-1 YEAR | -40 to 125 | LC244A | Samples |
| SN74LVC244ARWPR | ACTIVE | X1QFN | RWP | 20 | 2000 | RoHS & Green | NIPDAU | Level-1-260C-UNLIM | -40 to 125 | LC244A | Samples |

(1) The marketing status values are defined as follows:

ACTIVE: Product device recommended for new designs.

LIFEBUY: TI has announced that the device will be discontinued, and a lifetime-buy period is in effect.

NRND: Not recommended for new designs. Device is in production to support existing customers, but TI does not recommend using this part in a new design.

PREVIEW: Device has been announced but is not in production. Samples may or may not be available.

OBSELETE: TI has discontinued the production of the device.

(2) **RoHS:** TI defines "RoHS" to mean semiconductor products that are compliant with the current EU RoHS requirements for all 10 RoHS substances, including the requirement that RoHS substance do not exceed 0.1% by weight in homogeneous materials. Where designed to be soldered at high temperatures, "RoHS" products are suitable for use in specified lead-free processes. TI may reference these types of products as "Pb-Free".

RoHS Exempt: TI defines "RoHS Exempt" to mean products that contain lead but are compliant with EU RoHS pursuant to a specific EU RoHS exemption.

Green: TI defines "Green" to mean the content of Chlorine (Cl) and Bromine (Br) based flame retardants meet JS709B low halogen requirements of <=1000ppm threshold. Antimony trioxide based flame retardants must also meet the <=1000ppm threshold requirement.

(3) MSL, Peak Temp. - The Moisture Sensitivity Level rating according to the JEDEC industry standard classifications, and peak solder temperature.

(4) There may be additional marking, which relates to the logo, the lot trace code information, or the environmental category on the device.

(5) Multiple Device Markings will be inside parentheses. Only one Device Marking contained in parentheses and separated by a "~" will appear on a device. If a line is indented then it is a continuation of the previous line and the two combined represent the entire Device Marking for that device.

(6) Lead finish/Ball material - Orderable Devices may have multiple material finish options. Finish options are separated by a vertical ruled line. Lead finish/Ball material values may wrap to two lines if the finish value exceeds the maximum column width.

Important Information and Disclaimer: The information provided on this page represents TI's knowledge and belief as of the date that it is provided. TI bases its knowledge and belief on information provided by third parties, and makes no representation or warranty as to the accuracy of such information. Efforts are underway to better integrate information from third parties. TI has taken and continues to take reasonable steps to provide representative and accurate information but may not have conducted destructive testing or chemical analysis on incoming materials and chemicals. TI and TI suppliers consider certain information to be proprietary, and thus CAS numbers and other limited information may not be available for release.

In no event shall TI's liability arising out of such information exceed the total purchase price of the TI part(s) at issue in this document sold by TI to Customer on an annual basis.

TAPE AND REEL INFORMATION

QUADRANT ASSIGNMENTS FOR PIN 1 ORIENTATION IN TAPE

*All dimensions are nominal

| Device | Package Type | Package Drawing | Pins | SPQ | Reel Diameter (mm) | Reel Width W1 (mm) | A0 (mm) | B0 (mm) | K0 (mm) | P1 (mm) | W (mm) | Pin1 Quadrant |
|------------------|--------------|-----------------|------|------|--------------------|--------------------|---------|---------|---------|---------|--------|---------------|
| SN74LVC244ADBR | SSOP | DB | 20 | 2000 | 330.0 | 16.4 | 8.2 | 7.5 | 2.5 | 12.0 | 16.0 | Q1 |
| SN74LVC244ADGVR | TVSOP | DGV | 20 | 2000 | 330.0 | 12.4 | 6.9 | 5.6 | 1.6 | 8.0 | 12.0 | Q1 |
| SN74LVC244ADWR | SOIC | DW | 20 | 2000 | 330.0 | 24.4 | 10.9 | 13.3 | 2.7 | 12.0 | 24.0 | Q1 |
| SN74LVC244ADWR | SOIC | DW | 20 | 2000 | 330.0 | 24.4 | 10.8 | 13.3 | 2.7 | 12.0 | 24.0 | Q1 |
| SN74LVC244ADWRG4 | SOIC | DW | 20 | 2000 | 330.0 | 24.4 | 10.8 | 13.3 | 2.7 | 12.0 | 24.0 | Q1 |
| SN74LVC244ANSR | SO | NS | 20 | 2000 | 330.0 | 24.4 | 8.4 | 13.0 | 2.5 | 12.0 | 24.0 | Q1 |
| SN74LVC244APWR | TSSOP | PW | 20 | 2000 | 330.0 | 16.4 | 6.95 | 7.0 | 1.4 | 8.0 | 16.0 | Q1 |
| SN74LVC244APWR | TSSOP | PW | 20 | 2000 | 330.0 | 16.4 | 6.95 | 7.1 | 1.6 | 8.0 | 16.0 | Q1 |
| SN74LVC244APWRG3 | TSSOP | PW | 20 | 2000 | 330.0 | 16.4 | 6.95 | 7.1 | 1.6 | 8.0 | 16.0 | Q1 |
| SN74LVC244APWRG4 | TSSOP | PW | 20 | 2000 | 330.0 | 16.4 | 6.95 | 7.0 | 1.4 | 8.0 | 16.0 | Q1 |
| SN74LVC244APWT | TSSOP | PW | 20 | 250 | 330.0 | 16.4 | 6.95 | 7.0 | 1.4 | 8.0 | 16.0 | Q1 |
| SN74LVC244ARGYR | VQFN | RGY | 20 | 3000 | 330.0 | 12.4 | 3.8 | 4.8 | 1.6 | 8.0 | 12.0 | Q1 |
| SN74LVC244ARWPR | X1QFN | RWP | 20 | 2000 | 178.0 | 13.5 | 2.85 | 3.65 | 0.75 | 8.0 | 12.0 | Q1 |

TAPE AND REEL BOX DIMENSIONS

*All dimensions are nominal

| Device | Package Type | Package Drawing | Pins | SPQ | Length (mm) | Width (mm) | Height (mm) |
|------------------|--------------|-----------------|------|------|-------------|------------|-------------|
| SN74LVC244ADBR | SSOP | DB | 20 | 2000 | 356.0 | 356.0 | 35.0 |
| SN74LVC244ADGVR | TVSOP | DGV | 20 | 2000 | 356.0 | 356.0 | 35.0 |
| SN74LVC244ADWR | SOIC | DW | 20 | 2000 | 367.0 | 367.0 | 45.0 |
| SN74LVC244ADWR | SOIC | DW | 20 | 2000 | 364.0 | 361.0 | 36.0 |
| SN74LVC244ADWRG4 | SOIC | DW | 20 | 2000 | 367.0 | 367.0 | 45.0 |
| SN74LVC244ANSR | SO | NS | 20 | 2000 | 367.0 | 367.0 | 45.0 |
| SN74LVC244APWR | TSSOP | PW | 20 | 2000 | 356.0 | 356.0 | 35.0 |
| SN74LVC244APWR | TSSOP | PW | 20 | 2000 | 364.0 | 364.0 | 27.0 |
| SN74LVC244APWRG3 | TSSOP | PW | 20 | 2000 | 364.0 | 364.0 | 27.0 |
| SN74LVC244APWRG4 | TSSOP | PW | 20 | 2000 | 356.0 | 356.0 | 35.0 |
| SN74LVC244APWT | TSSOP | PW | 20 | 250 | 356.0 | 356.0 | 35.0 |
| SN74LVC244ARGYR | VQFN | RGY | 20 | 3000 | 356.0 | 356.0 | 35.0 |
| SN74LVC244ARWPR | X1QFN | RWP | 20 | 2000 | 189.0 | 185.0 | 36.0 |

TUBE

*All dimensions are nominal

| Device | Package Name | Package Type | Pins | SPQ | L (mm) | W (mm) | T (μm) | B (mm) |
|-----------------|--------------|--------------|------|-----|--------|--------|--------|--------|
| SN74LVC244ADW | DW | SOIC | 20 | 25 | 507 | 12.83 | 5080 | 6.6 |
| SN74LVC244ADWE4 | DW | SOIC | 20 | 25 | 507 | 12.83 | 5080 | 6.6 |
| SN74LVC244ADWG4 | DW | SOIC | 20 | 25 | 507 | 12.83 | 5080 | 6.6 |
| SN74LVC244AN | N | PDIP | 20 | 20 | 506 | 13.97 | 11230 | 4.32 |
| SN74LVC244APW | PW | TSSOP | 20 | 70 | 530 | 10.2 | 3600 | 3.5 |
| SN74LVC244APWE4 | PW | TSSOP | 20 | 70 | 530 | 10.2 | 3600 | 3.5 |
| SN74LVC244APWG4 | PW | TSSOP | 20 | 70 | 530 | 10.2 | 3600 | 3.5 |

PW0020A



PACKAGE OUTLINE

TSSOP - 1.2 mm max height

SMALL OUTLINE PACKAGE



4220206/A 02/2017

NOTES:

1. All linear dimensions are in millimeters. Any dimensions in parenthesis are for reference only. Dimensioning and tolerancing per ASME Y14.5M.
2. This drawing is subject to change without notice.
3. This dimension does not include mold flash, protrusions, or gate burrs. Mold flash, protrusions, or gate burrs shall not exceed 0.15 mm per side.
4. This dimension does not include interlead flash. Interlead flash shall not exceed 0.25 mm per side.
5. Reference JEDEC registration MO-153.

EXAMPLE BOARD LAYOUT

PW0020A

TSSOP - 1.2 mm max height

SMALL OUTLINE PACKAGE



LAND PATTERN EXAMPLE
EXPOSED METAL SHOWN
SCALE: 10X



SOLDER MASK DETAILS

4220206/A 02/2017

NOTES: (continued)

- 6. Publication IPC-7351 may have alternate designs.
- 7. Solder mask tolerances between and around signal pads can vary based on board fabrication site.

EXAMPLE STENCIL DESIGN

PW0020A

TSSOP - 1.2 mm max height

SMALL OUTLINE PACKAGE



SOLDER PASTE EXAMPLE
BASED ON 0.125 mm THICK STENCIL
SCALE: 10X

4220206/A 02/2017

NOTES: (continued)

8. Laser cutting apertures with trapezoidal walls and rounded corners may offer better paste release. IPC-7525 may have alternate design recommendations.
9. Board assembly site may have different recommendations for stencil design.

PW (R-PDSO-G20)

PLASTIC SMALL OUTLINE



- NOTES:
- A. All linear dimensions are in millimeters.
 - B. This drawing is subject to change without notice.
 - C. Publication IPC-7351 is recommended for alternate design.
 - D. Laser cutting apertures with trapezoidal walls and also rounding corners will offer better paste release. Customers should contact their board assembly site for stencil design recommendations. Refer to IPC-7525 for other stencil recommendations.
 - E. Customers should contact their board fabrication site for solder mask tolerances between and around signal pads.

DB0020A



PACKAGE OUTLINE

SSOP - 2 mm max height

SMALL OUTLINE PACKAGE



4214851/B 08/2019

NOTES:

1. All linear dimensions are in millimeters. Any dimensions in parenthesis are for reference only. Dimensioning and tolerancing per ASME Y14.5M.
2. This drawing is subject to change without notice.
3. This dimension does not include mold flash, protrusions, or gate burrs. Mold flash, protrusions, or gate burrs shall not exceed 0.15 mm per side.
4. This dimension does not include interlead flash. Interlead flash shall not exceed 0.25 mm per side.
5. Reference JEDEC registration MO-150.

EXAMPLE BOARD LAYOUT

DB0020A

SSOP - 2 mm max height

SMALL OUTLINE PACKAGE



LAND PATTERN EXAMPLE
EXPOSED METAL SHOWN
SCALE: 10X



4214851/B 08/2019

NOTES: (continued)

- 6. Publication IPC-7351 may have alternate designs.
- 7. Solder mask tolerances between and around signal pads can vary based on board fabrication site.

EXAMPLE STENCIL DESIGN

DB0020A

SSOP - 2 mm max height

SMALL OUTLINE PACKAGE



SOLDER PASTE EXAMPLE
BASED ON 0.125 mm THICK STENCIL
SCALE: 10X

4214851/B 08/2019

NOTES: (continued)

8. Laser cutting apertures with trapezoidal walls and rounded corners may offer better paste release. IPC-7525 may have alternate design recommendations.
9. Board assembly site may have different recommendations for stencil design.

MECHANICAL DATA

NS (R-PDSO-G**)

PLASTIC SMALL-OUTLINE PACKAGE

14-PINS SHOWN



- NOTES:
- A. All linear dimensions are in millimeters.
 - B. This drawing is subject to change without notice.
 - C. Body dimensions do not include mold flash or protrusion, not to exceed 0,15.

GENERIC PACKAGE VIEW

RGY 20

VQFN - 1 mm max height

3.5 x 4.5, 0.5 mm pitch

PLASTIC QUAD FGLATPACK - NO LEAD

This image is a representation of the package family, actual package may vary.
Refer to the product data sheet for package details.



4225264/A



4225320/A 09/2019

NOTES:

1. All linear dimensions are in millimeters. Any dimensions in parenthesis are for reference only. Dimensioning and tolerancing per ASME Y14.5M.
2. This drawing is subject to change without notice.
3. The package thermal pad must be soldered to the printed circuit board for thermal and mechanical performance.

EXAMPLE BOARD LAYOUT

RGY0020A

VQFN - 1 mm max height

PLASTIC QUAD FLATPACK - NO LEAD



LAND PATTERN EXAMPLE
EXPOSED METAL SHOWN
SCALE:18X



SOLDER MASK DETAILS

4225320/A 09/2019

NOTES: (continued)

- This package is designed to be soldered to a thermal pad on the board. For more information, see Texas Instruments literature number SLUA271 (www.ti.com/lit/slua271).
- Vias are optional depending on application, refer to device data sheet. If any vias are implemented, refer to their locations shown on this view. It is recommended that vias under paste be filled, plugged or tented.

EXAMPLE STENCIL DESIGN

RGY0020A

VQFN - 1 mm max height

PLASTIC QUAD FLATPACK - NO LEAD



SOLDER PASTE EXAMPLE
 BASED ON 0.125 mm THICK STENCIL

EXPOSED PAD 21
 78% PRINTED SOLDER COVERAGE BY AREA UNDER PACKAGE
 SCALE:20X

4225320/A 09/2019

NOTES: (continued)

6. Laser cutting apertures with trapezoidal walls and rounded corners may offer better paste release. IPC-7525 may have alternate design recommendations.

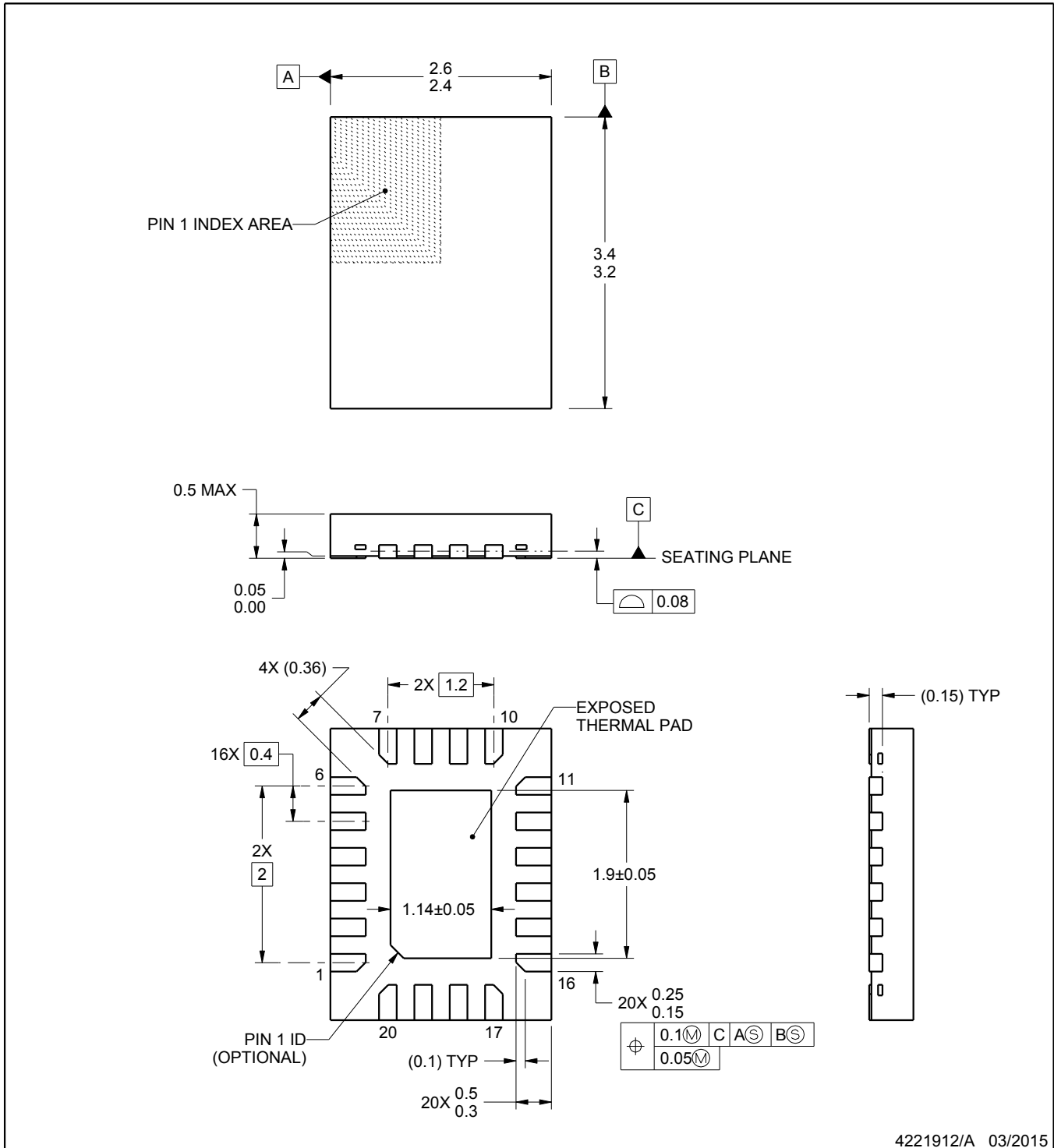
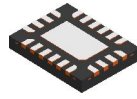

4221912/A 03/2015

NOTES:

1. All linear dimensions are in millimeters. Any dimensions in parenthesis are for reference only. Dimensioning and tolerancing per ASME Y14.5M.
2. This drawing is subject to change without notice.
3. The package thermal pad must be soldered to the printed circuit board for thermal and mechanical performance.

EXAMPLE BOARD LAYOUT

RWP0020A

X1QFN - 0.5 mm max height

PLASTIC QUAD FLATPACK - NO LEAD

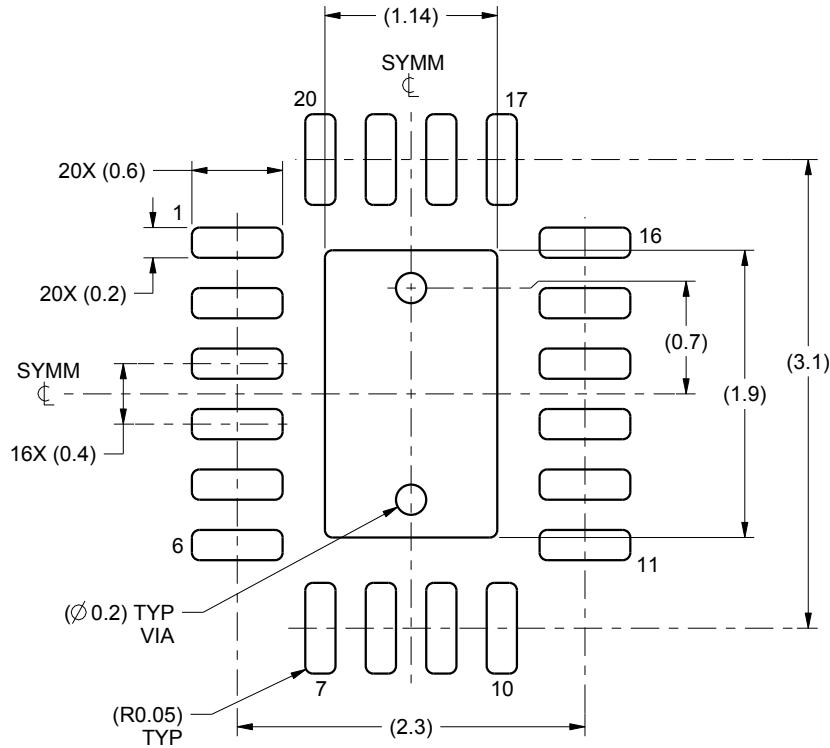

LAND PATTERN EXAMPLE
SCALE:20X

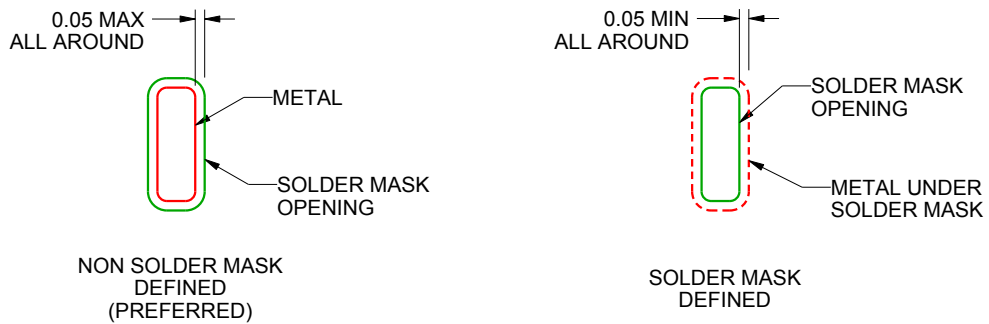

SOLDER MASK DETAILS

4221912/A 03/2015

NOTES: (continued)

4. This package is designed to be soldered to a thermal pad on the board. For more information, see Texas Instruments literature number SLUA271 (www.ti.com/lit/slua271).

EXAMPLE STENCIL DESIGN

RWP0020A

X1QFN - 0.5 mm max height

PLASTIC QUAD FLATPACK - NO LEAD

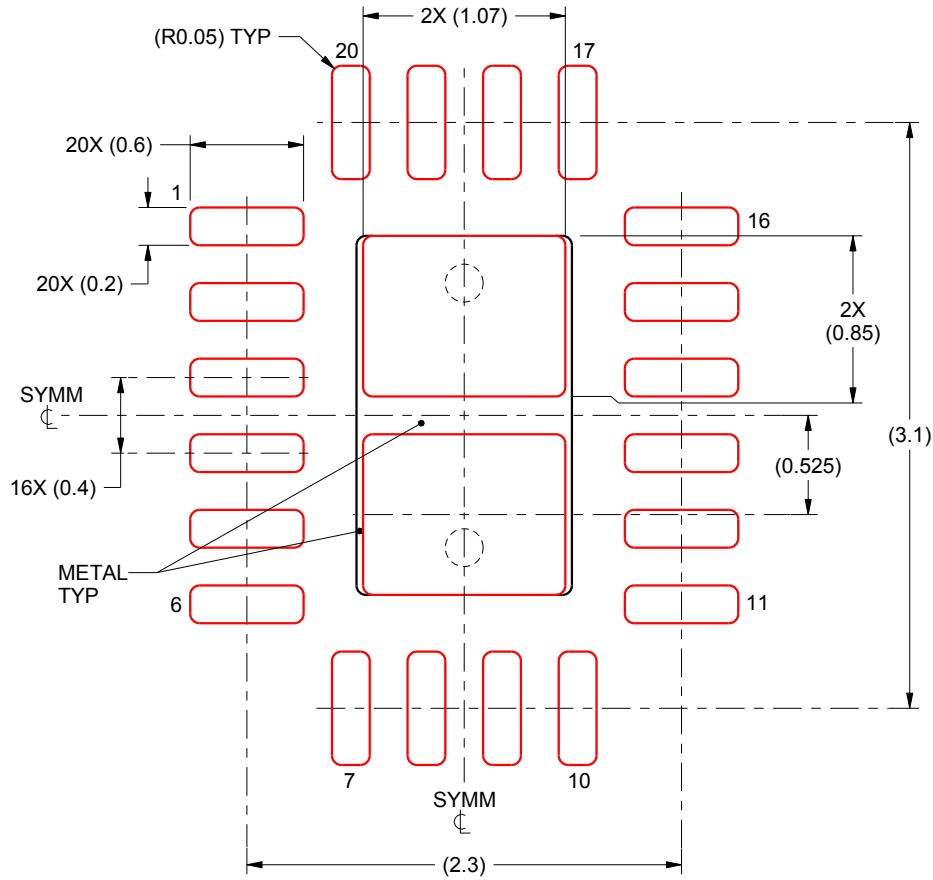

SOLDER PASTE EXAMPLE BASED ON 0.1 mm THICK STENCIL

EXPOSED PAD
84% PRINTED SOLDER COVERAGE BY AREA
SCALE:25X

4221912/A 03/2015

NOTES: (continued)

5. Laser cutting apertures with trapezoidal walls and rounded corners may offer better paste release. IPC-7525 may have alternate design recommendations.

N (R-PDIP-T**)

PLASTIC DUAL-IN-LINE PACKAGE

16 PINS SHOWN



- NOTES:
- A. All linear dimensions are in inches (millimeters).
 - B. This drawing is subject to change without notice.
 - Falls within JEDEC MS-001, except 18 and 20 pin minimum body length (Dim A).
 - The 20 pin end lead shoulder width is a vendor option, either half or full width.

DW0020A



PACKAGE OUTLINE

SOIC - 2.65 mm max height

SOIC



4220724/A 05/2016

NOTES:

1. All linear dimensions are in millimeters. Dimensions in parenthesis are for reference only. Dimensioning and tolerancing per ASME Y14.5M.
2. This drawing is subject to change without notice.
3. This dimension does not include mold flash, protrusions, or gate burrs. Mold flash, protrusions, or gate burrs shall not exceed 0.15 mm per side.
4. This dimension does not include interlead flash. Interlead flash shall not exceed 0.43 mm per side.
5. Reference JEDEC registration MS-013.

EXAMPLE BOARD LAYOUT

DW0020A

SOIC - 2.65 mm max height

SOIC



LAND PATTERN EXAMPLE
SCALE:6X



SOLDER MASK DETAILS

4220724/A 05/2016

NOTES: (continued)

- 6. Publication IPC-7351 may have alternate designs.
- 7. Solder mask tolerances between and around signal pads can vary based on board fabrication site.

EXAMPLE STENCIL DESIGN

DW0020A

SOIC - 2.65 mm max height

SOIC



SOLDER PASTE EXAMPLE
BASED ON 0.125 mm THICK STENCIL
SCALE:6X

4220724/A 05/2016

NOTES: (continued)

8. Laser cutting apertures with trapezoidal walls and rounded corners may offer better paste release. IPC-7525 may have alternate design recommendations.
9. Board assembly site may have different recommendations for stencil design.

重要声明和免责声明

TI“按原样”提供技术和可靠性数据（包括数据表）、设计资源（包括参考设计）、应用或其他设计建议、网络工具、安全信息和其他资源，不保证没有瑕疵且不做任何明示或暗示的担保，包括但不限于对适销性、某特定用途方面的适用性或不侵犯任何第三方知识产权的暗示担保。

这些资源可供使用 TI 产品进行设计的熟练开发人员使用。您将自行承担以下全部责任：(1) 针对您的应用选择合适的 TI 产品，(2) 设计、验证并测试您的应用，(3) 确保您的应用满足相应标准以及任何其他功能安全、信息安全、监管或其他要求。

这些资源如有变更，恕不另行通知。TI 授权您仅可将这些资源用于研发本资源所述的 TI 产品的应用。严禁对这些资源进行其他复制或展示。您无权使用任何其他 TI 知识产权或任何第三方知识产权。您应全额赔偿因在这些资源的使用中对 TI 及其代表造成的任何索赔、损害、成本、损失和债务，TI 对此概不负责。

TI 提供的产品受 [TI 的销售条款](#) 或 [ti.com](#) 上其他适用条款/TI 产品随附的其他适用条款的约束。TI 提供这些资源并不会扩展或以其他方式更改 TI 针对 TI 产品发布的适用的担保或担保免责声明。

TI 反对并拒绝您可能提出的任何其他或不同的条款。

邮寄地址：Texas Instruments, Post Office Box 655303, Dallas, Texas 75265

Copyright © 2023，德州仪器 (TI) 公司