



## 门控 H 类、双端口 VDSL2 线路驱动器

 查询样品: [THS6226](#)

### 特性

- 数字式可调节静态电流:  
**7.6mA 至 23.0mA**
- **1.0mA** 偏置电流步进
- 独立的升压和主线路驱动器停用
- 低功耗线路终端模式
- 完整的电容器再充电: **3ms**
- 低输出电压噪声密度:  
**6.3 nV/√Hz Input-Referred Voltage Noise**
- 低 MTPR 失真:  
**70dB with +19.8dBm G.993.2—Profile 8b**
- **-91dBc HD3 (1MHz, 60Ω 差分负载)**
- 高输出电流: (可向 **60Ω** 负载输送 **383mA** 的电流)
- 宽输出摆幅: **40V<sub>PP</sub>** (+12V, 100Ω 差分负载和一个 **1:1.4** 变压器)
- 大带宽: **125MHz**
- 端口至端口隔离度: 在 **1MHz** 频率下为 **90dB**
- 在 **1MHz** 频率下提供了 **50dB** 的 **PSRR** 以实现优良的隔离

### 应用

- 非常适合于所有的 **VDSL2** 传输模式
- 返回兼容 **ADSL / ADSL2+ / ADSL2++** 系统

### 说明

THS6226 是一款双端口、H 类、电流反馈架构、差分线路驱动器放大器系统,非常适合于 xDSL 系统。该器件旨在应用于 VDSL2 (超高位速率数字用户线路 2) 线路驱动器系统,此类系统可启用本地 DTM 信号,同时支持高于 +20.5dBm 的线路功率(在高达 8.5MHz 的频率条件下)和上佳的线性度,从而支持 G.993.2 VDSL2 8b 传输模式。另外,它还拥有足以支持 +14.5dBm 线路功率(在高达 30MHz 的频率下)的中心局传输的高速度。

THS6226 的独特架构提供了极小的静态电流,同时仍然实现了超高的线性度。在全偏置条件和 1MHz 频率下,差分失真为 -91dBc,而在 5MHz 频率下则降至仅 -75dBc。对于并不需要放大器全部性能的线路长度,放大器的多种固定偏置设定值可提升节能效果。为了在所有的传输模式中提供更大的灵活性及节能幅度,可对静态电流进行数字式调节(调节范围从 7.67mA 至 23mA),并具有一个 1.0mA 的偏置电流步进。对于那些希望在不进行传输的时候实现更多节能的系统,THS6226 可在其线路终端模式中使用,以保持阻抗匹配。

采用 +12V 电源时的宽输出摆幅与出色的电流驱动能力相结合,提供了宽动态余量,从而将失真抑制在极低的水平上。

THS6226 采用 QFN-32 PowerPAD™ 封装。

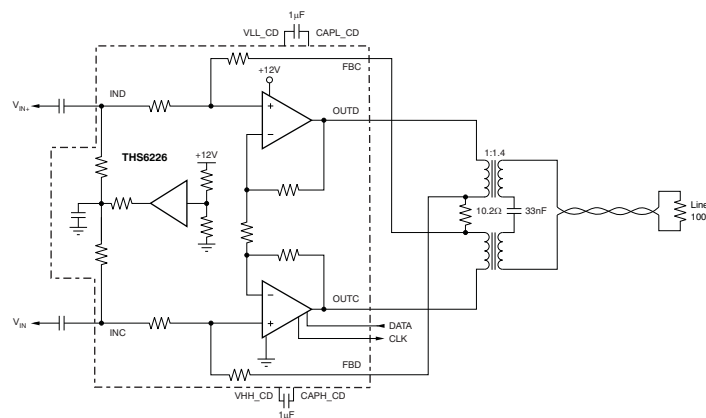

利用 THS6226 的一个端口的典型 VDSL2 线路驱动器电路



Please be aware that an important notice concerning availability, standard warranty, and use in critical applications of Texas Instruments semiconductor products and disclaimers thereto appears at the end of this data sheet.

PowerPAD is a trademark of Texas Instruments, Inc.

All other trademarks are the property of their respective owners.

PRODUCTION DATA information is current as of publication date. Products conform to specifications per the terms of the Texas Instruments standard warranty. Production processing does not necessarily include testing of all parameters.

Copyright © 2011, Texas Instruments Incorporated  
English Data Sheet: [SBOS499C](#)



This integrated circuit can be damaged by ESD. Texas Instruments recommends that all integrated circuits be handled with appropriate precautions. Failure to observe proper handling and installation procedures can cause damage.

ESD damage can range from subtle performance degradation to complete device failure. Precision integrated circuits may be more susceptible to damage because very small parametric changes could cause the device not to meet its published specifications.

### ORDERING INFORMATION<sup>(1)</sup>

PRODUCT <sup>(2)</sup>	PACKAGE-LEAD	PACKAGE DESIGNATOR	PACKAGE MARKING	TRANSPORT MEDIA, QUANTITY
THS6226IRHBT	VQFN-32	RHB	THS6226IRHB	Tape and Reel, 250
THS6226IRHBR				Tape and Reel, 3000

- (1) For the most current package and ordering information, see the Package Option Addendum at the end of this document, or visit the device product folder at [www.ti.com](http://www.ti.com).
- (2) The PowerPAD is electrically isolated from all other pins.

### ABSOLUTE MAXIMUM RATINGS<sup>(1)</sup>

Over operating free-air temperature range, unless otherwise noted.

PARAMETER		THS6226	UNIT
Supply voltage, GND to $V_{S+}$ , class AB only		15	V
Supply voltage, GND to $V_{S+}$ , class H only		12.5	V
Input voltage, $V_I$		15	V
Output current, $I_O$ : static dc <sup>(2)</sup>		±100	mA
Continuous power dissipation		See <a href="#">Thermal Information</a> table	
Normal storage temperature		–40 to +85	°C
Maximum junction temperature, any condition, $T_J$ <sup>(3)</sup>		+150	°C
Maximum junction temperature, continuous operation, long-term reliability, $T_J$ <sup>(4)</sup>		+130	°C
Storage temperature range, $T_{STG}$		–65 to +150	°C
ESD ratings:	Human body model (HBM)	2000	V
	Charged device model (CDM)	500	V
	Machine model (MM)	100	V

- (1) Stresses above those listed under *absolute maximum ratings* may cause permanent damage to the device. These are stress ratings only, and functional operation of the device at these or any other conditions beyond those indicated under *recommended operating conditions* is not implied. Exposure to absolute maximum rated conditions for extended periods may degrade device reliability.
- (2) The THS6226 incorporates a PowerPAD on the underside of the chip. This acts as a heatsink and must be connected to a thermally dissipating plane for proper power dissipation. Failure to do so may result in exceeding the maximum junction temperature which could permanently damage the device. See TI Technical Brief [SLMA002](#) for more information about utilizing the PowerPAD thermally-enhanced package. Under high-frequency ac operation (> 10kHz), the short-term output current capability is much greater than the continuous dc output current rating. This short-term output current rating is about 8.5x the dc capability, or approximately ±850mA.
- (3) The absolute maximum junction temperature under any condition is limited by the constraints of the silicon process.
- (4) The absolute maximum junction temperature for continuous operation is limited by the package constraints. Operation above this temperature may result in reduced reliability and/or lifetime of the device.

### THERMAL INFORMATION

THERMAL METRIC <sup>(1)</sup>		THS6226	UNITS
		RHB	
		32 PINS	
$\theta_{JA}$	Junction-to-ambient thermal resistance	35.1	°C/W
$\theta_{JCTop}$	Junction-to-case (top) thermal resistance	22.1	
$\theta_{JB}$	Junction-to-board thermal resistance	7.0	
$\Psi_{JT}$	Junction-to-top characterization parameter	0.3	
$\Psi_{JB}$	Junction-to-board characterization parameter	6.9	
$\theta_{JCbott}$	Junction-to-case (bottom) thermal resistance	1.3	

- (1) For more information about traditional and new thermal metrics, see the *IC Package Thermal Metrics* application report, [SPRA953](#).

**ELECTRICAL CHARACTERISTICS:  $V_S = +12V$** 
**Boldface** limits are tested at **+25°C**.

 At  $T_A = +25^\circ\text{C}$ , with  $R_{MATCH} = 10.2\Omega$ , transformer turn ratio 1:1.4,  $R_L = 100\Omega$  differential at transformer output, Full Bias Mode, and active impedance circuit configuration, unless otherwise noted. Each port is tested independently.

PARAMETER	CONDITIONS	THS6226IRHB			UNIT	TEST LEVEL <sup>(1)</sup>
		MIN	TYP	MAX		
<b>AC PERFORMANCE</b>						
Small-signal bandwidth, –3dB	$V_O = 2V_{PP}$ , differential at OUTCD and OUTAB, gain = 19V/V		125		MHz	C
0.1dB bandwidth flatness	$V_O = 2V_{PP}$		37		MHz	C
Large-signal bandwidth	$V_O = 10V_{PP}$		125		MHz	C
Slew rate (10% to 90% level)	$V_O = 15V$ step, differential		1500		V/ $\mu\text{s}$	C
Rise and fall time	$V_O = 2V_{PP}$		2.8		ns	C
Harmonic distortion	$V_O = 2V_{PP}$ , $R_L = 60\Omega$ differential					C
Second harmonic	Full bias, $f = 1\text{MHz}$		–91		dBc	C
Third harmonic	Full bias, $f = 1\text{MHz}$		–91		dBc	C
Second harmonic	Full bias, $f = 5\text{MHz}$		–70		dBc	C
	Low bias, $f = 5\text{MHz}$		–64		dBc	C
Third harmonic	Full bias, $f = 5\text{MHz}$		–75		dBc	C
	Low bias, $f = 5\text{MHz}$		–47		dBc	C
Differential input voltage noise	$f = 1\text{MHz}$ , input-referred		6.3		nV/ $\sqrt{\text{Hz}}$	C
<b>DC PERFORMANCE</b>						
Differential gain			19		V/V	C
Differential gain error <sup>(2)</sup>				$\pm 2.5$	%	A
Input offset voltage			$\pm 1$	$\pm 5$	mV	A
	–40°C to +85°C			$\pm 6$	mV	B
Input offset voltage drift				15	$\mu\text{V}/^\circ\text{C}$	B
Input offset voltage matching	Channels 1 to 2 and 3 to 4 only		$\pm 1$	$\pm 5$	mV	A
<b>INPUT CHARACTERISTICS</b>						
Noninverting input resistance			500    2		k $\Omega$    pF	C
Input bias voltage		<b>5.8</b>	6	<b>6.2</b>	V	A
<b>OUTPUT CHARACTERISTICS</b>						
Class H output voltage swing	$R_L = 60\Omega$ differential, class H operation <sup>(3)(4)</sup> , each output	<b>+16/–4</b>	+17.5/–5.5		V	A
	–40°C to +85°C <sup>(3)(4)</sup>	+15.7/–3.7			V	B
Class H output current (sourcing, sinking)	$R_L = 60\Omega$ differential, class H operation	<b><math>\pm 333</math></b>	$\pm 383$		mA	A
	–40°C to +85°C	$\pm 323$			mA	B
Class AB output voltage swing	$R_L = 60\Omega$ differential, normal operation <sup>(3)</sup> , each output	<b>+9.9/+2.1</b>	+10.1/+1.9		V	A
	–40°C to +85°C <sup>(3)</sup>	+9.8/+2.2			V	B
Class AB output current (sourcing, sinking)	$R_L = 60\Omega$ differential, normal operation	<b><math>\pm 130</math></b>	$\pm 137$		mA	A
	–40°C to +85°C	$\pm 126$			mA	B
Short-circuit output current			1		A	C
Output impedance	$f = 1\text{MHz}$ , differential		0.2		$\Omega$	C
Crosstalk	$f = 1\text{MHz}$ , $V_{OUT} = 2V_{PP}$ , port 1 to port 2		–90		dB	C

- (1) Test levels: **(A)** 100% tested at +25°C. Over temperature limits set by characterization and simulation. **(B)** Limits set by characterization and simulation. **(C)** Typical value only for information.
- (2) Negative feedback loop only.
- (3) Measured at amplifier output (pin 17, 20, 21, and 24).
- (4) Capacitor fully charged, no droop.

**ELECTRICAL CHARACTERISTICS:  $V_S = +12V$  (continued)**

**Boldface** limits are tested at **+25°C**.

At  $T_A = +25^\circ\text{C}$ , with  $R_{MATCH} = 10.2\Omega$ , transformer turn ratio 1:1.4,  $R_L = 100\Omega$  differential at transformer output, Full Bias Mode, and active impedance circuit configuration, unless otherwise noted. Each port is tested independently.

PARAMETER	CONDITIONS	THS6226IRHB			UNIT	TEST LEVEL <sup>(1)</sup>
		MIN	TYP	MAX		
<b>POWER SUPPLY</b>						
Maximum operating voltage	Class AB	<b>+10</b>	+12	<b>+15</b>	V	A
	–40°C to +85°C	+10		+15	V	B
	Class H	+10	+12	+12.5	V	B
	–40°C to +85°C	+10		+12.5		B
$I_{S+}$ quiescent current	Per port, full bias, class H enable (power supply connected together)	<b>22.5</b>	23.5	<b>24.5</b>	mA	A
	–40°C to +85°C	<b>21.8</b>		<b>25.2</b>	mA	B
	Per port, full bias, class H disable (power supply connected together)	<b>22.0</b>	23.0	<b>24.0</b>	mA	A
	–40°C to +85°C	<b>21.3</b>		24.7	mA	B
	Bias current step		1.0		mA	C
	Per port, low bias, class H disable (power supply connected together)	<b>7.2</b>	7.6	<b>8</b>	mA	A
	–40°C to +85°C	<b>6.9</b>		8.3	mA	B
	Per port, line termination mode (B9 = B8 = B7 = B6 = 0) (power supply connected together)		4.4		mA	C
	Both ports, main amplifiers and class H disable (B9 = B8 = B7 = B6 = 0)		1.7	<b>2.2</b>	mA	A
–40°C to +85°C			2.3	mA	B	
Power-supply rejection (PSRR)	Differential, from +12V, GND	<b>60</b>	70		dB	A
	–40°C to +85°C	58			dB	B
<b>LOGIC</b>						
Logic pin logic threshold	Logic 1, with respect to GND <sup>(5)</sup>	1.9			V	C
	Logic 0, with respect to GND <sup>(5)</sup>			0.8	V	C
Logic pin quiescent current	Logic X = 0.5V (logic 0)		10	<b>25</b>	$\mu\text{A}$	A
	–40°C to +85°C			30	$\mu\text{A}$	B
	Logic X = 3.3V (logic 1)		66	<b>125</b>	$\mu\text{A}$	A
	–40°C to +85°C			130	$\mu\text{A}$	B
Turn-on time delay ( $t_{ON}$ )	Time for $I_S$ to reach 50% of final value		1		$\mu\text{s}$	C
Turn-off time delay ( $t_{OFF}$ )	Time for $I_S$ to reach 50% of final value		1		$\mu\text{s}$	C
Logic pin input impedance			50    1		k $\Omega$    pF	C

(5) The GND pin usable range is from  $V_{S-}$  to  $(V_{S+} - 5V)$ .

## PIN CONFIGURATIONS

### QFN-32<sup>(1)(2)</sup> RHB PACKAGE (TOP VIEW)

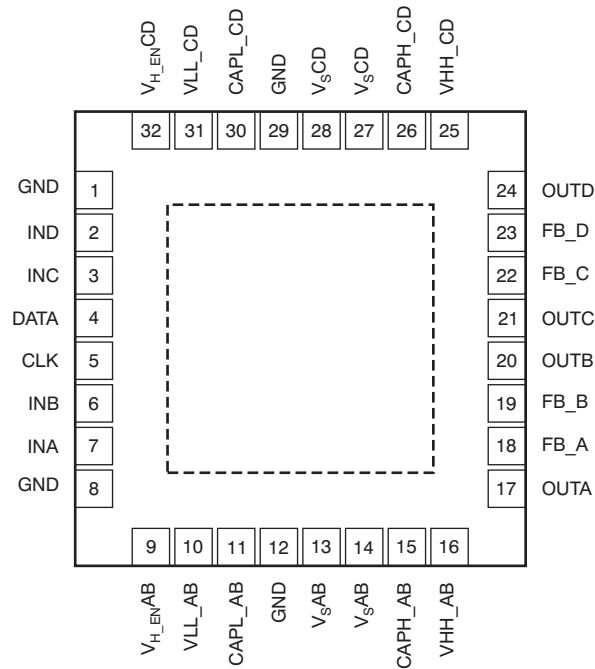

- (1) The PowerPAD is electrically isolated from all other pins and can be connected to any potential voltage range from  $V_{S-}$  to  $V_{S+}$ . Typically, the PowerPAD is connected to the GND plane because this plane tends to physically be the largest and is able to dissipate the most amount of heat.
- (2) The THS6226 defaults to the disabled mode at power-up.

## PIN DESCRIPTIONS

NAME	PIN	DESCRIPTION
GND	1	Analog ground
IND	2	Input D of amplifier CD
INC	3	Input C of amplifier CD
DATA	4	Serial interface data pin
CLK	5	Serial interface CLK pin
INB	6	Input B of amplifier AB
INA	7	Input A of amplifier AB
GND	8	Analog ground
V <sub>H_ENAB</sub>	9	Class H mode control pin for amplifier AB
VLL_AB	10	Amplifier AB low pump supply
CAPL_AB	11	Amplifier AB negative voltage pump capacitor pin
GND	12	Analog ground
V <sub>SAB</sub>	13	Amplifier AB supply voltage
V <sub>SAB</sub>	14	Amplifier AB supply voltage
CAPH_AB	15	Amplifier AB positive voltage pump capacitor pin
VHH_AB	16	Amplifier AB high pump supply
OUTA	17	Output A of amplifier AB
FB_A	18	Feedback for active output impedance of amplifier AB
FB_B	19	Feedback for active output impedance of amplifier AB
OUTB	20	Output B of amplifier AB
OUTC	21	Output C of amplifier CD
FB_C	22	Feedback for active output impedance of amplifier CD
FB_D	23	Feedback for active output impedance of amplifier CD
OUTD	24	Output D of amplifier CD
VHH_CD	25	Amplifier CD high pump supply
CAPH_CD	26	Amplifier CD positive voltage pump capacitor pin
V <sub>SCD</sub>	27	Amplifier CD supply voltage
V <sub>SCD</sub>	28	Amplifier CD supply voltage
GND	29	Analog ground
CAPL_CD	30	Amplifier CD negative voltage pump capacitor pin
VLL_CD	31	Amplifier CD low pump supply
V <sub>H_ENCD</sub>	32	Class H mode control pin for amplifier CD

## TIMING CHARACTERISTICS

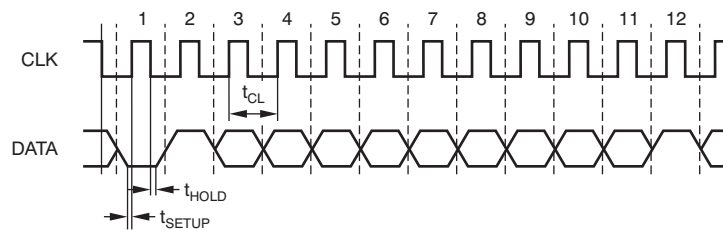

Figure 1. Serial Interface Timing

PARAMETER	DESCRIPTION	THS6226		UNITS
		MIN	MAX	
$t_{\text{SETUP}}$	Setup time	3		ns
$t_{\text{HOLD}}$	Hold time	0.5		ns
$t_{\text{CL}}$	Clock period	200		ns

**TYPICAL CHARACTERISTICS:  $V_S = +12V$**

At  $T_A = +25^\circ C$  and Full Bias Mode, unless otherwise noted

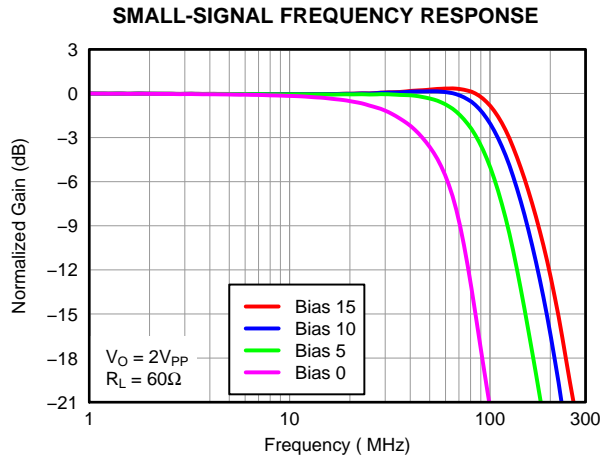

Figure 2.

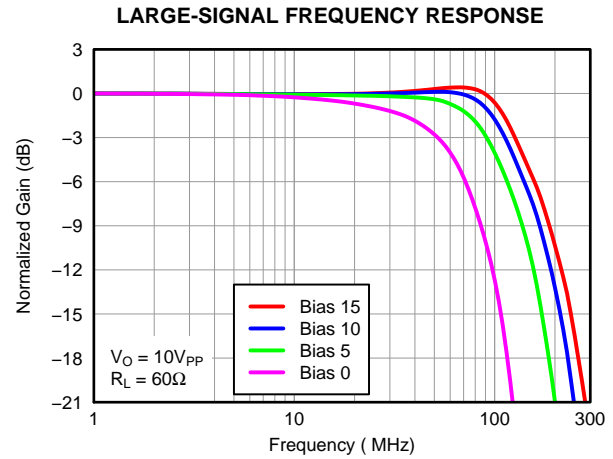

Figure 3.

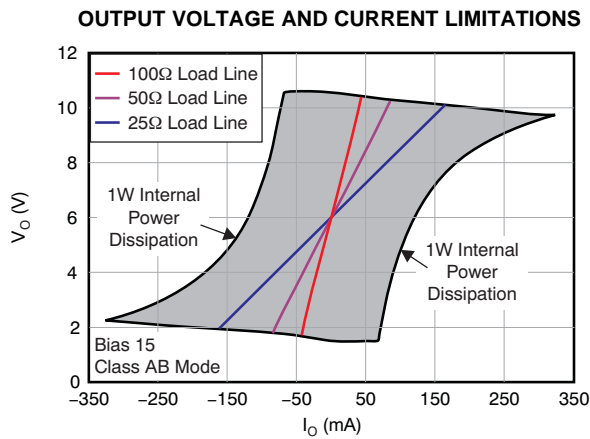

Figure 4.

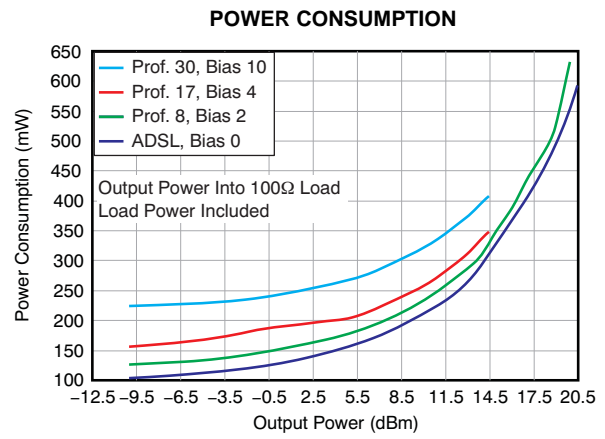

Figure 5.

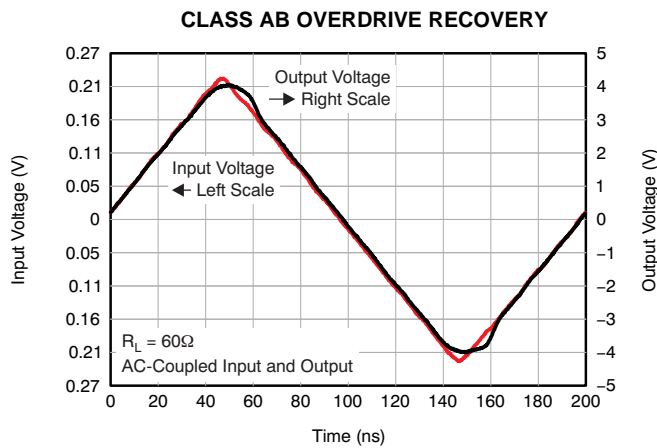

Figure 6.

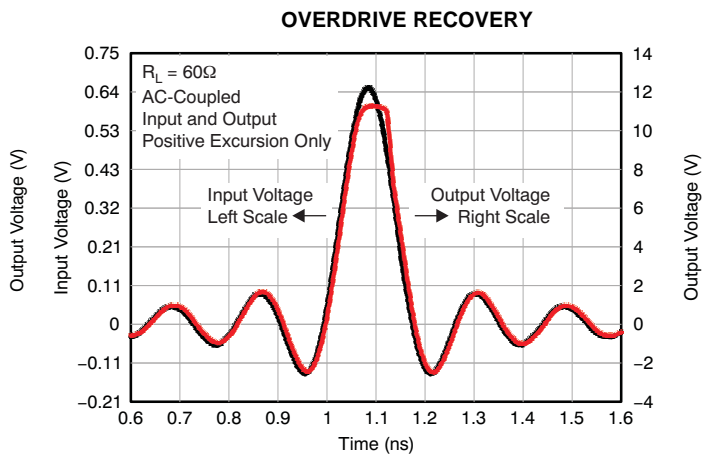
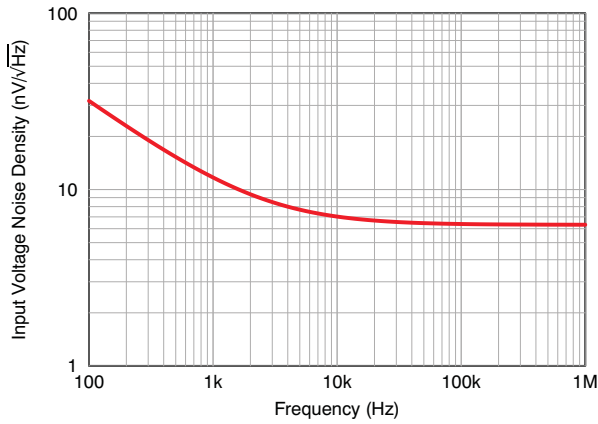

Figure 7.

**TYPICAL CHARACTERISTICS:  $V_S = +12V$  (continued)**

At  $T_A = +25^\circ C$  and Full Bias Mode, unless otherwise noted

**INPUT NOISE DENSITY**



**Figure 8.**

**HARMONIC DISTORTION vs FREQUENCY**

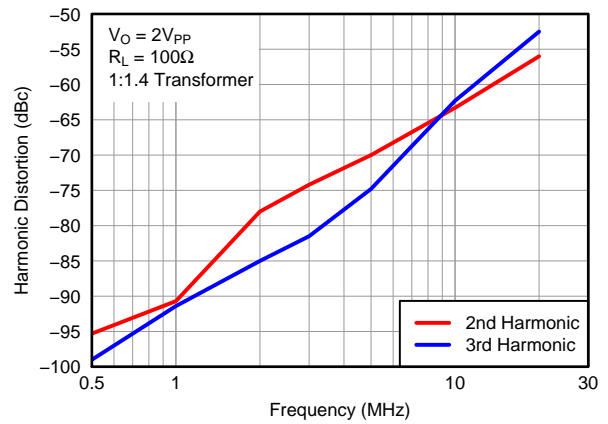

**Figure 9.**

**HARMONIC DISTORTION vs LOAD**

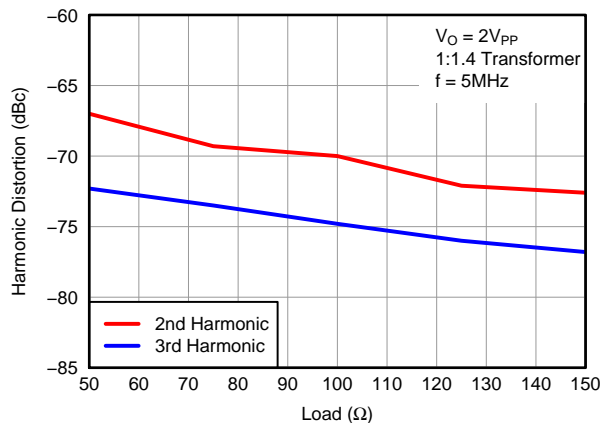

**Figure 10.**

**TWO-TONE, THIRD-ORDER INTERMODULATION SPURIOUS**

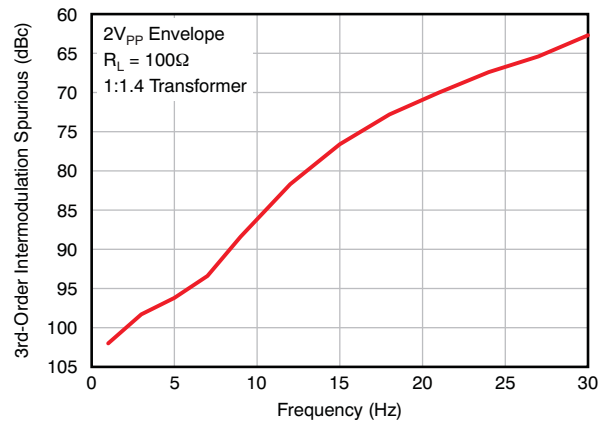

**Figure 11.**

**HARMONIC DISTORTION vs OUTPUT VOLTAGE**

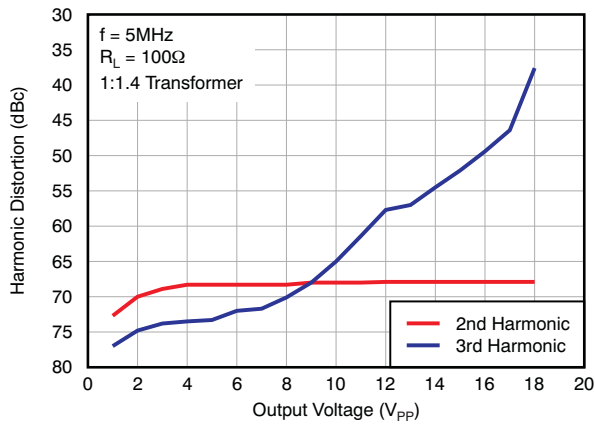

**Figure 12.**

**HARMONIC DISTORTION vs BIAS CURRENT**

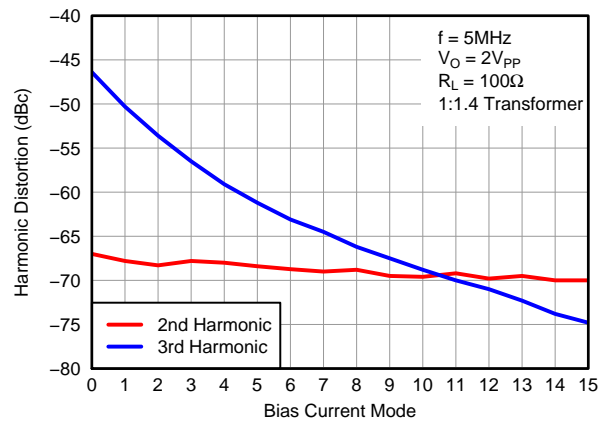

**Figure 13.**



**TYPICAL CHARACTERISTICS:  $V_S = +12V$  (continued)**

At  $T_A = +25^\circ C$  and Full Bias Mode, unless otherwise noted

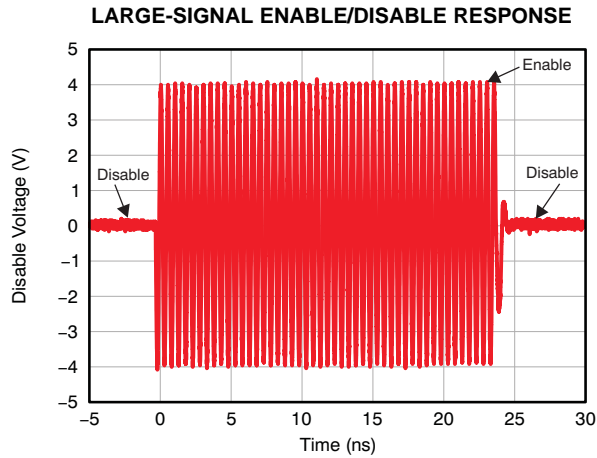

Figure 14.

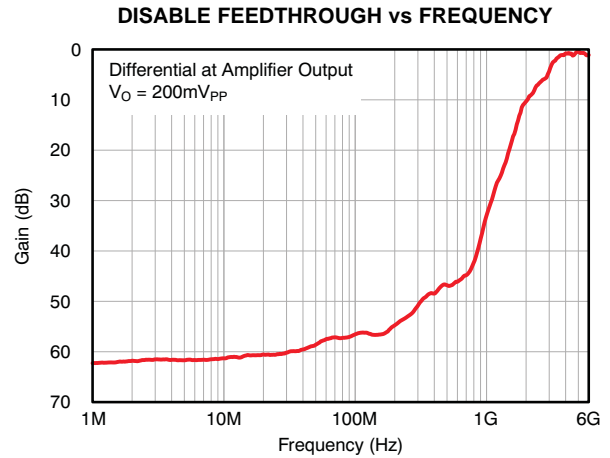

Figure 15.

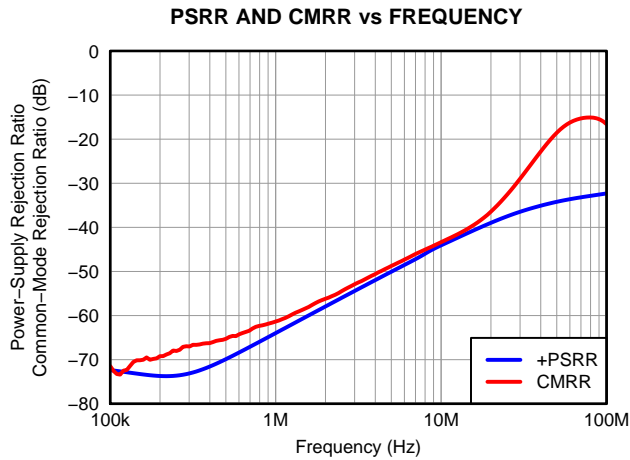

Figure 16.

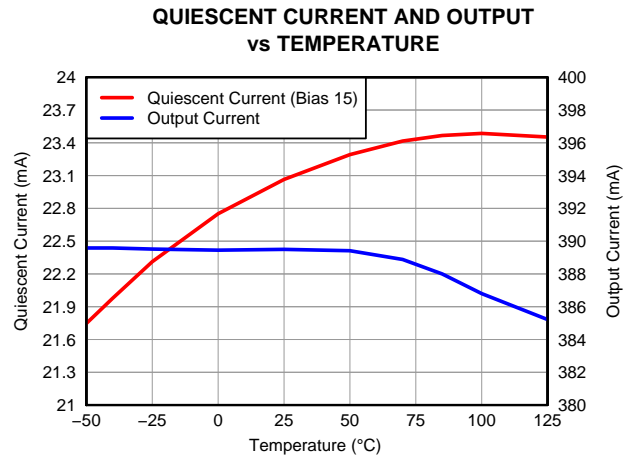

Figure 17.

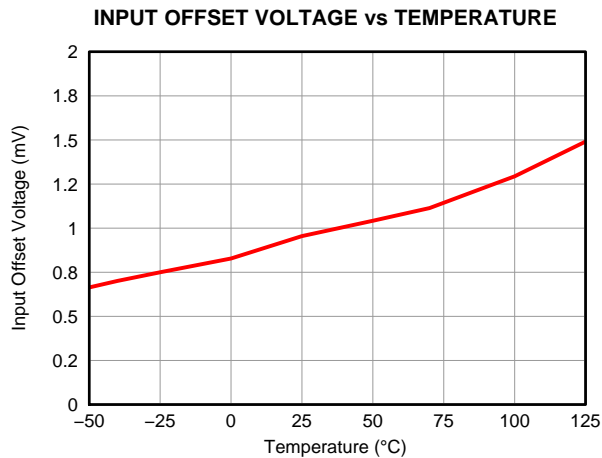

Figure 18.

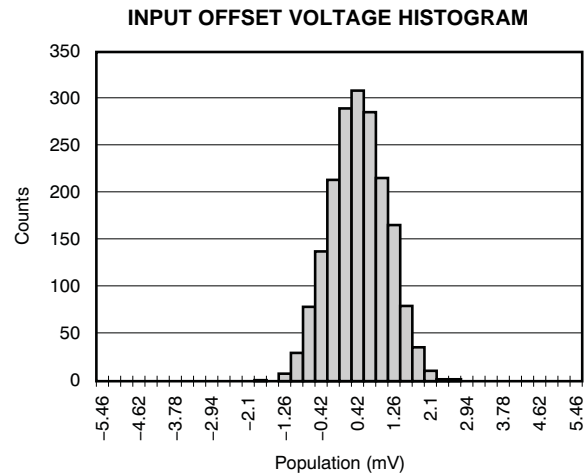

Figure 19.

### APPLICATION INFORMATION

The THS6226 class H line driver provides exceptional ac performance in conjunction with wide output voltage swing. The class H operation allows voltage swings to exceed the power supply for short intervals limited only by the charge in the capacitor. In class AB mode, the THS6226 is capable of driving a 60Ω load from +1.9V to +10.1V. In class H mode, under the same conditions, the output voltage range becomes an impressive –5.5V to +17.5V, or 46V<sub>PP</sub> differentially with the capacitor fully charged.

Figure 20 shows a fully-differential, noninverting amplifier configuration with active impedance. In this configuration, the 10.2Ω matching resistance appears through the transformer as 100Ω, minimizing reflection on the line, while also minimizing transmission losses. The THS6226 gain is fixed and equal to 19V/V from input of the amplifier to the output of the amplifier (IN<sub>CD</sub> to OUT<sub>CD</sub>), not including the transformer-turn ratio.

To simplify the implementation as well as provide design flexibility, the THS6226 contains an integrated mid-supply buffer that provides the correct biasing to the amplifier core without requiring any external components. Also present is a two-pin serial interface that provides exceptional design flexibility and allows minimal power consumption for each xDSL profile.

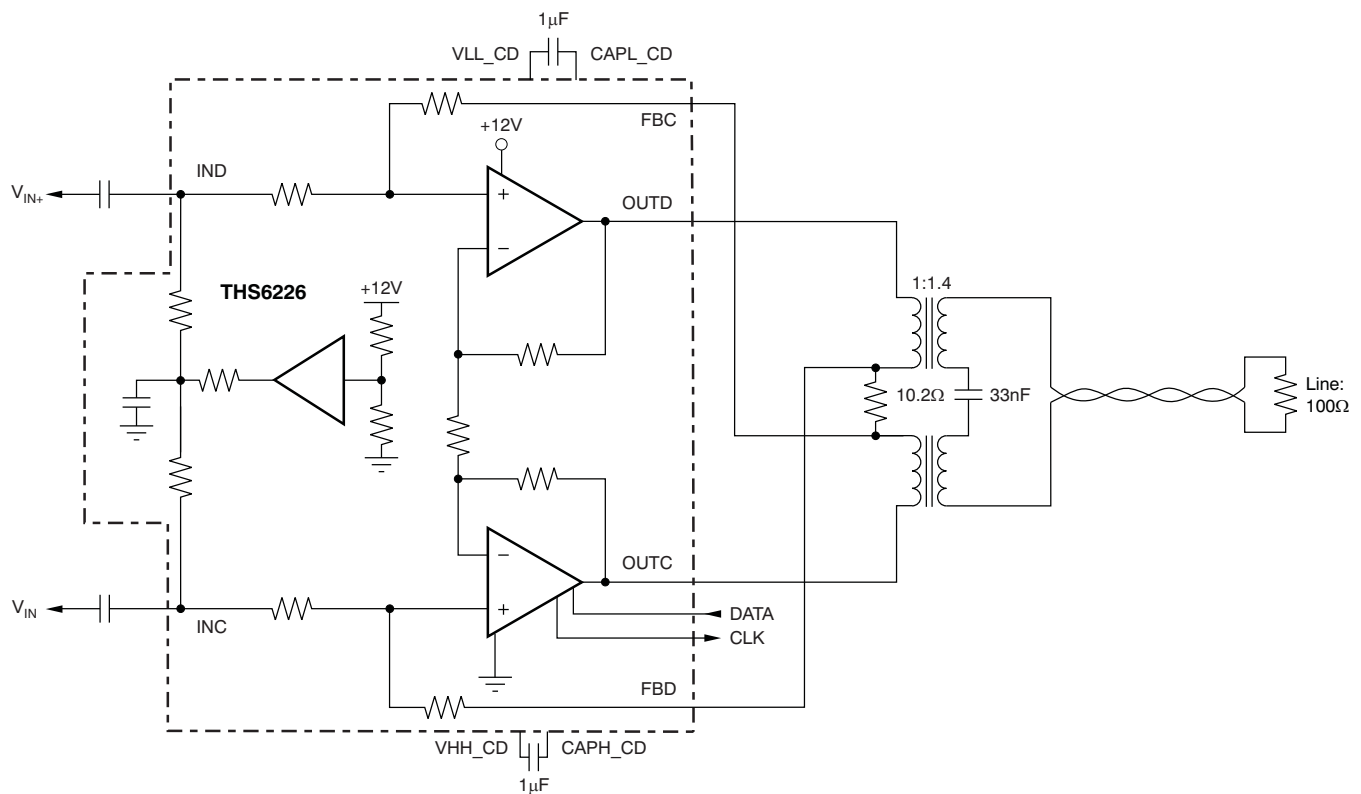

Figure 20. Multi-Tone Power Ratio (MTPR) Test Circuit

## PROGRAMMING THE THS6226

Programming of the THS6226 is realized through a serial interface (pins 4 and 5) and proceeds in the following sequence.

Two start bits are required B0 = 0 followed by B1 = 1.

B2 through B9 are used to program the THS6226.

Refer to [Table 1](#) for the bit descriptions.

B10 (refer to [Table 2](#)) is the parity bit that controls if the word is or is not loaded.

B11 is the stop bit and should be set to B11 = 1. [Figure 21](#) shows the sequence to be adopted.

**Table 1. SDATA**

PARAMETER	DESCRIPTION
B0, B1	Start bit
B2, B3	Channel select
B4, B5	Power-down features
B6-B9	Quiescent current setting
B10	Parity bit
B11	Stop bit

**Table 2. Parity Bit**

B10	ODD PARITY BIT
0	If odd, number of high bits in B2 to B9
1	If even, number of high bits in B2 to B9

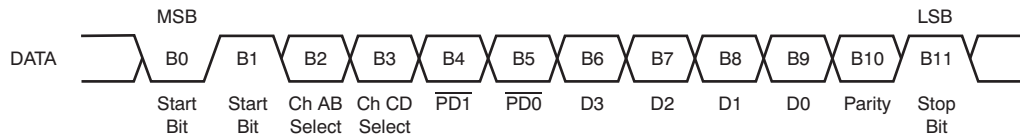

**Figure 21. DATA Description**

## QUIESCENT CURRENT

The quiescent current of the THS6226 is dissipated in two main modules of the THS6226: the class AB and the charge pump. B4 and B5 select the mode of operation, class AB operating with or without the charge pump enabled, powering down the entire port, or operating in a line termination mode. [Table 4](#) lists the details on each bit functionality and the approximate quiescent current.

The class AB quiescent current is set by bits B6 to B9, using B4 and B5 for the power-down function, and B2 and B3 for channel select. The approximate quiescent current for the amplifier core is shown in [Table 3](#).

**Table 3. Class AB Quiescent Current**

B6 (D3)	B7 (D2)	B8 (D1)	B9 (D0)	QUIESCENT CURRENT SETTING	APPROXIMATE $I_Q$ (mA/Port)
0	0	0	0	ADSL2+ mode	7.6
0	0	0	1		8.7
0	0	1	0	Profile 8b mode	9.8
0	0	1	1		10.9
0	1	0	0	Profile 17a mode	12
0	1	0	1		13
0	1	1	0		14
0	1	1	1		15
1	0	0	0		16
1	0	0	1		17
1	0	1	0	Profile 30a mode	18
1	0	1	1		19
1	1	0	0		20
1	1	0	1		21
1	1	1	0		22
1	1	1	1		23

The various power modes are shown in [Table 4](#). For all modes, when B6 through B9 are not defined, set B9 = B8 = B7 = B6 = 0 to achieve the lowest power dissipation possible.

**Table 4. Power Modes**

B4 (PD1)	B5 (PD0)	POWER-DOWN MODE	APPROXIMATE $I_Q$ (mA/Port)
0	0	Power-down (B9, B8, B7, B6 = 0)	0.85
0	1	Line termination mode (B9, B8, B7, B6 = 0)	4.4
1	0	Class AB driver $I_Q$ set by B6 to B9, class H disabled	—
1	1	Class AB driver $I_Q$ set by B6 to B9, class H enabled	—

Channel selection is shown in [Table 5](#). Each channel can be programmed independently, or together if both B2 and B3 are set to '1'.

**Table 5. Channel Selection**

B2 (Channel AB)	B3 (Channel CD)	CHANNEL SELECT
0	0	Bits B4 to B9 are ignored
0	1	Channel B programmed with B4 to B9
1	0	Channel A programmed with B4 to B9
1	1	Channels A and B programmed with B4 to B9

At startup, the internal register is set as shown in [Table 6](#).

**Table 6. Internal Register**

B2 (Channel AB)	B3 (Channel CD)	B4 (PD1)	B5 (PD0)	B6 (D3)	B7 (D2)	B8 (D1)	B9 (D0)
0	0	0	0	0	0	0	0

In this condition, the total quiescent power dissipation is 10.2mW/port on a +12V supply.

## REVISION HISTORY

NOTE: Page numbers for previous revisions may differ from page numbers in the current version.

Changes from Revision B (February 2011) to Revision C	Page
• Changed LOGIC, <i>Logic pin input impedance</i> typical specification and unit in Electrical Characteristics table .....	4
• Changed Timing Characteristics section .....	6

## 重要声明

德州仪器 (TI) 及其下属子公司有权在不事先通知的情况下, 随时对所提供的产品和服务进行更正、修改、增强、改进或其它更改, 并有权随时中止提供任何产品和服务。客户在下订单前应获取最新的相关信息, 并验证这些信息是否完整且是最新的。所有产品的销售都遵循在订单确认时所提供的 TI 销售条款与条件。

TI 保证其所销售的硬件产品的性能符合 TI 标准保修的适用规范。仅在 TI 保修的范围内, 且 TI 认为有必要时才会使用测试或其它质量控制技术。除非政府做出了硬性规定, 否则没有必要对每种产品的所有参数进行测试。

TI 对应用帮助或客户产品设计不承担任何义务。客户应对其使用 TI 组件的产品和应用自行负责。为尽量减小与客户产品和应用相关的风险, 客户应提供充分的设计与操作安全措施。

TI 不对任何 TI 专利权、版权、屏蔽作品权或其它与使用了 TI 产品或服务的组合设备、机器、流程相关的 TI 知识产权中授予的直接或隐含权限作出任何保证或解释。TI 所发布的与第三方产品或服务有关的信息, 不能构成从 TI 获得使用这些产品或服务的许可、授权、或认可。使用此类信息可能需要获得第三方的专利权或其它知识产权方面的许可, 或是 TI 的专利权或其它知识产权方面的许可。

对于 TI 的数据手册或数据表, 仅在没有对内容进行任何篡改且带有相关授权、条件、限制和声明的情况下才允许进行复制。在复制信息的过程中对内容的篡改属于非法的、欺诈性商业行为。TI 对此类篡改过的文件不承担任何责任。

在转售 TI 产品或服务时, 如果存在对产品或服务参数的虚假陈述, 则会失去相关 TI 产品或服务的明示或暗示授权, 且这是非法的、欺诈性商业行为。TI 对此类虚假陈述不承担任何责任。

可访问以下 URL 地址以获取有关其它 TI 产品和应用解决方案的信息:

### 产品

放大器	<a href="http://www.ti.com.cn/amplifiers">http://www.ti.com.cn/amplifiers</a>
数据转换器	<a href="http://www.ti.com.cn/dataconverters">http://www.ti.com.cn/dataconverters</a>
DSP	<a href="http://www.ti.com.cn/dsp">http://www.ti.com.cn/dsp</a>
接口	<a href="http://www.ti.com.cn/interface">http://www.ti.com.cn/interface</a>
逻辑	<a href="http://www.ti.com.cn/logic">http://www.ti.com.cn/logic</a>
电源管理	<a href="http://www.ti.com.cn/power">http://www.ti.com.cn/power</a>
微控制器	<a href="http://www.ti.com.cn/microcontrollers">http://www.ti.com.cn/microcontrollers</a>

### 应用

音频	<a href="http://www.ti.com.cn/audio">http://www.ti.com.cn/audio</a>
汽车	<a href="http://www.ti.com.cn/automotive">http://www.ti.com.cn/automotive</a>
宽带	<a href="http://www.ti.com.cn/broadband">http://www.ti.com.cn/broadband</a>
数字控制	<a href="http://www.ti.com.cn/control">http://www.ti.com.cn/control</a>
光纤网络	<a href="http://www.ti.com.cn/opticalnetwork">http://www.ti.com.cn/opticalnetwork</a>
安全	<a href="http://www.ti.com.cn/security">http://www.ti.com.cn/security</a>
电话	<a href="http://www.ti.com.cn/telecom">http://www.ti.com.cn/telecom</a>
视频与成像	<a href="http://www.ti.com.cn/video">http://www.ti.com.cn/video</a>
无线	<a href="http://www.ti.com.cn/wireless">http://www.ti.com.cn/wireless</a>

邮寄地址: Texas Instruments, Post Office Box 655303, Dallas, Texas 75265  
Copyright © 2006, Texas Instruments Incorporated

**PACKAGING INFORMATION**

Orderable Device	Status (1)	Package Type	Package Drawing	Pins	Package Qty	Eco Plan (2)	Lead finish/ Ball material (6)	MSL Peak Temp (3)	Op Temp (°C)	Device Marking (4/5)	Samples
THS6226IRHBR	LIFEBUY	VQFN	RHB	32	3000	RoHS & Green	NIPDAU	Level-3-260C-168 HR	-40 to 85	THS6226 IRHB	
THS6226IRHBT	LIFEBUY	VQFN	RHB	32	250	RoHS & Green	NIPDAU	Level-3-260C-168 HR	-40 to 85	THS6226 IRHB	

(1) The marketing status values are defined as follows:

**ACTIVE:** Product device recommended for new designs.

**LIFEBUY:** TI has announced that the device will be discontinued, and a lifetime-buy period is in effect.

**NRND:** Not recommended for new designs. Device is in production to support existing customers, but TI does not recommend using this part in a new design.

**PREVIEW:** Device has been announced but is not in production. Samples may or may not be available.

**OBSOLETE:** TI has discontinued the production of the device.

(2) **RoHS:** TI defines "RoHS" to mean semiconductor products that are compliant with the current EU RoHS requirements for all 10 RoHS substances, including the requirement that RoHS substance do not exceed 0.1% by weight in homogeneous materials. Where designed to be soldered at high temperatures, "RoHS" products are suitable for use in specified lead-free processes. TI may reference these types of products as "Pb-Free".

**RoHS Exempt:** TI defines "RoHS Exempt" to mean products that contain lead but are compliant with EU RoHS pursuant to a specific EU RoHS exemption.

**Green:** TI defines "Green" to mean the content of Chlorine (Cl) and Bromine (Br) based flame retardants meet JS709B low halogen requirements of <=1000ppm threshold. Antimony trioxide based flame retardants must also meet the <=1000ppm threshold requirement.

(3) MSL, Peak Temp. - The Moisture Sensitivity Level rating according to the JEDEC industry standard classifications, and peak solder temperature.

(4) There may be additional marking, which relates to the logo, the lot trace code information, or the environmental category on the device.

(5) Multiple Device Markings will be inside parentheses. Only one Device Marking contained in parentheses and separated by a "~" will appear on a device. If a line is indented then it is a continuation of the previous line and the two combined represent the entire Device Marking for that device.

(6) Lead finish/Ball material - Orderable Devices may have multiple material finish options. Finish options are separated by a vertical ruled line. Lead finish/Ball material values may wrap to two lines if the finish value exceeds the maximum column width.

**Important Information and Disclaimer:**The information provided on this page represents TI's knowledge and belief as of the date that it is provided. TI bases its knowledge and belief on information provided by third parties, and makes no representation or warranty as to the accuracy of such information. Efforts are underway to better integrate information from third parties. TI has taken and continues to take reasonable steps to provide representative and accurate information but may not have conducted destructive testing or chemical analysis on incoming materials and chemicals. TI and TI suppliers consider certain information to be proprietary, and thus CAS numbers and other limited information may not be available for release.

In no event shall TI's liability arising out of such information exceed the total purchase price of the TI part(s) at issue in this document sold by TI to Customer on an annual basis.





**TAPE AND REEL INFORMATION**

**QUADRANT ASSIGNMENTS FOR PIN 1 ORIENTATION IN TAPE**

\*All dimensions are nominal

Device	Package Type	Package Drawing	Pins	SPQ	Reel Diameter (mm)	Reel Width W1 (mm)	A0 (mm)	B0 (mm)	K0 (mm)	P1 (mm)	W (mm)	Pin1 Quadrant
THS6226IRHBR	VQFN	RHB	32	3000	330.0	12.4	5.3	5.3	1.1	8.0	12.0	Q2
THS6226IRHBT	VQFN	RHB	32	250	180.0	12.4	5.3	5.3	1.1	8.0	12.0	Q2

**TAPE AND REEL BOX DIMENSIONS**

\*All dimensions are nominal

Device	Package Type	Package Drawing	Pins	SPQ	Length (mm)	Width (mm)	Height (mm)
THS62261RHBR	VQFN	RHB	32	3000	346.0	346.0	33.0
THS62261RHBT	VQFN	RHB	32	250	210.0	185.0	35.0

## GENERIC PACKAGE VIEW

**RHB 32**

**VQFN - 1 mm max height**

5 x 5, 0.5 mm pitch

PLASTIC QUAD FLATPACK - NO LEAD



Images above are just a representation of the package family, actual package may vary.  
Refer to the product data sheet for package details.

4224745/A



4223442/B 08/2019

NOTES:

1. All linear dimensions are in millimeters. Any dimensions in parenthesis are for reference only. Dimensioning and tolerancing per ASME Y14.5M.
2. This drawing is subject to change without notice.
3. The package thermal pad must be soldered to the printed circuit board for thermal and mechanical performance.

# EXAMPLE BOARD LAYOUT

RHB0032E

VQFN - 1 mm max height

PLASTIC QUAD FLATPACK - NO LEAD



LAND PATTERN EXAMPLE  
SCALE:18X



SOLDER MASK DETAILS

4223442/B 08/2019

NOTES: (continued)

4. This package is designed to be soldered to a thermal pad on the board. For more information, see Texas Instruments literature number SLUA271 ([www.ti.com/lit/sluea271](http://www.ti.com/lit/sluea271)).
5. Vias are optional depending on application, refer to device data sheet. If any vias are implemented, refer to their locations shown on this view. It is recommended that vias under paste be filled, plugged or tented.

# EXAMPLE STENCIL DESIGN

RHB0032E

VQFN - 1 mm max height

PLASTIC QUAD FLATPACK - NO LEAD



**SOLDER PASTE EXAMPLE**  
 BASED ON 0.125 mm THICK STENCIL

EXPOSED PAD 33:  
 75% PRINTED SOLDER COVERAGE BY AREA UNDER PACKAGE  
 SCALE:20X

4223442/B 08/2019

NOTES: (continued)

6. Laser cutting apertures with trapezoidal walls and rounded corners may offer better paste release. IPC-7525 may have alternate design recommendations.

## 重要声明和免责声明

TI“按原样”提供技术和可靠性数据（包括数据表）、设计资源（包括参考设计）、应用或其他设计建议、网络工具、安全信息和其他资源，不保证没有瑕疵且不做任何明示或暗示的担保，包括但不限于对适销性、某特定用途方面的适用性或不侵犯任何第三方知识产权的暗示担保。

这些资源可供使用 TI 产品进行设计的熟练开发人员使用。您将自行承担以下全部责任：(1) 针对您的应用选择合适的 TI 产品，(2) 设计、验证并测试您的应用，(3) 确保您的应用满足相应标准以及任何其他功能安全、信息安全、监管或其他要求。

这些资源如有变更，恕不另行通知。TI 授权您仅可将这些资源用于研发本资源所述的 TI 产品的应用。严禁对这些资源进行其他复制或展示。您无权使用任何其他 TI 知识产权或任何第三方知识产权。您应全额赔偿因在这些资源的使用中对 TI 及其代表造成的任何索赔、损害、成本、损失和债务，TI 对此概不负责。

TI 提供的产品受 [TI 的销售条款](#) 或 [ti.com](#) 上其他适用条款/TI 产品随附的其他适用条款的约束。TI 提供这些资源并不会扩展或以其他方式更改 TI 针对 TI 产品发布的适用的担保或担保免责声明。

TI 反对并拒绝您可能提出的任何其他或不同的条款。

邮寄地址：Texas Instruments, Post Office Box 655303, Dallas, Texas 75265

Copyright © 2023，德州仪器 (TI) 公司