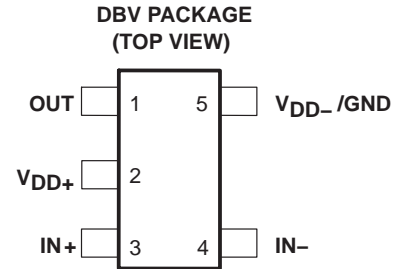


**TLV2721, TLV2721Y**  
**Advanced LinCMOS™ RAIL-TO-RAIL**  
**VERY LOW-POWER SINGLE OPERATIONAL AMPLIFIERS**

SLOS197A – AUGUST 1997 – REVISED MARCH 2001

- **Output Swing Includes Both Supply Rails**
- **Low Noise . . . 19 nV/√Hz Typ at f = 1 kHz**
- **Low Input Bias Current . . . 1 pA Typ**
- **Fully Specified for Single-Supply 3-V and 5-V Operation**
- **Very Low Power . . . 110 μA Typ**
- **Common-Mode Input Voltage Range Includes Negative Rail**
- **Wide Supply Voltage Range 2.7 V to 10 V**
- **Macromodel Included**



**description**

The TLV2721 is a single low-voltage operational amplifier available in the SOT-23 package. It offers a compromise between the ac performance and output drive of the TLV2731 and the micropower TLV2711.

It consumes only 150 μA (max) of supply current and is ideal for battery-powered applications. The device exhibits rail-to-rail output performance for increased dynamic range in single- or split-supply applications. The TLV2721 is fully characterized at 3 V and 5 V and is optimized for low-voltage applications.

The TLV2721, exhibiting high input impedance and low noise, is excellent for small-signal conditioning for high-impedance sources, such as piezoelectric transducers. Because of the micropower dissipation levels combined with 3-V operation, these devices work well in hand-held monitoring and remote-sensing applications. In addition, the rail-to-rail output feature with single or split supplies makes this family a great choice when interfacing with analog-to-digital converters (ADCs).

With a total area of 5.6mm<sup>2</sup>, the SOT-23 package only requires one third the board space of the standard 8-pin SOIC package. This ultra-small package allows designers to place single amplifiers very close to the signal source, minimizing noise pick-up from long PCB traces.

**AVAILABLE OPTIONS**

T <sub>A</sub>	V <sub>IO</sub> max AT 25°C	PACKAGED DEVICES	SYMBOL	CHIP FORM‡ (Y)
		SOT-23 (DBV)†		
0°C to 70°C	3 mV	TLV2721CDBV	VAKC	TLV2721Y
-40°C to 85°C	3 mV	TLV2721IDBV	VAKI	

† The DBV package available in tape and reel only.

‡ Chip forms are tested at T<sub>A</sub> = 25°C only.



Please be aware that an important notice concerning availability, standard warranty, and use in critical applications of Texas Instruments semiconductor products and disclaimers thereto appears at the end of this data sheet.

Advanced LinCMOS is a trademark of Texas Instruments.

PRODUCTION DATA information is current as of publication date. Products conform to specifications per the terms of Texas Instruments standard warranty. Production processing does not necessarily include testing of all parameters.



POST OFFICE BOX 655303 • DALLAS, TEXAS 75265

Copyright © 2001, Texas Instruments Incorporated

# TLV2721, TLV2721Y

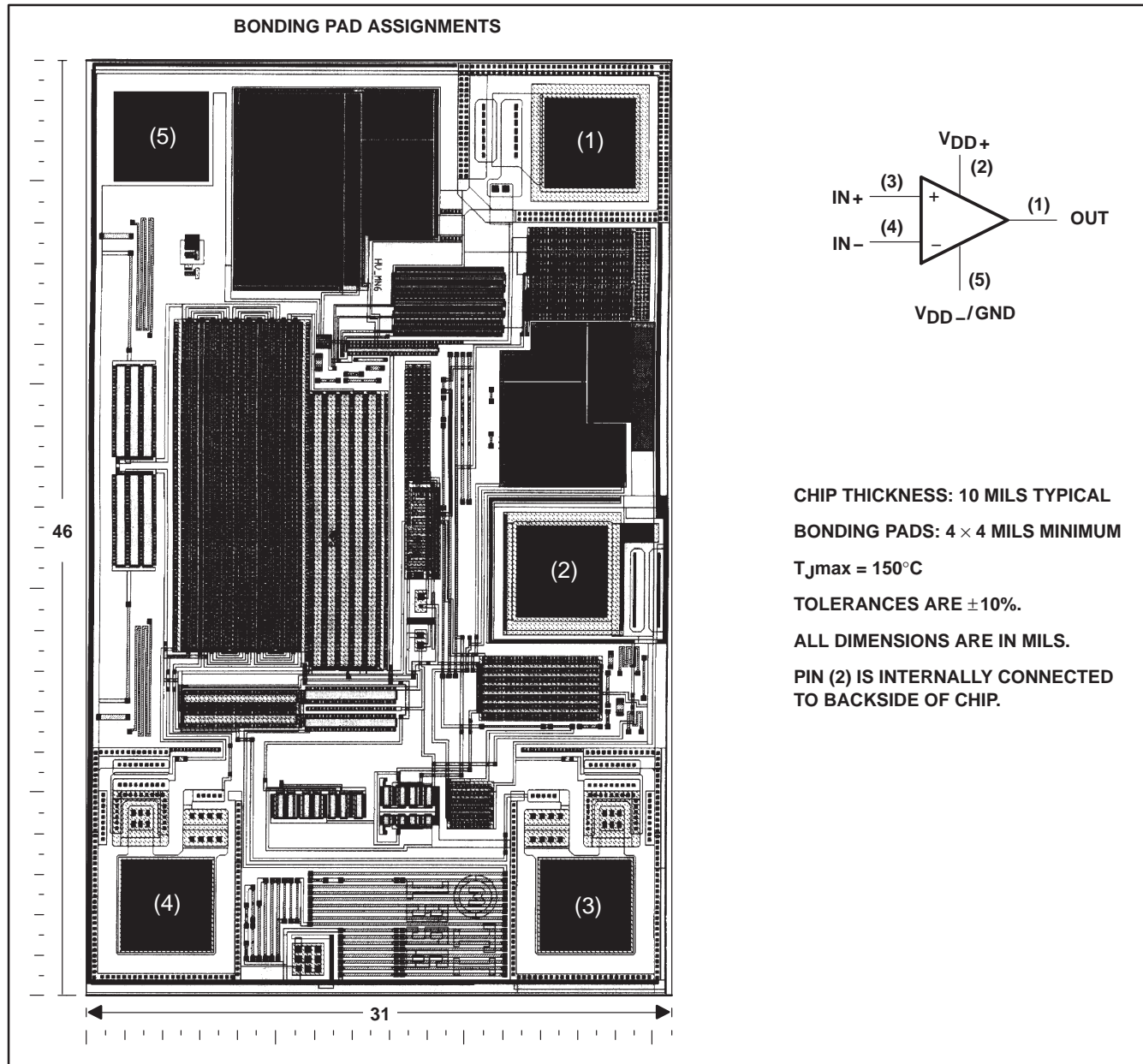
## Advanced LinCMOS™ RAIL-TO-RAIL

### VERY LOW-POWER SINGLE OPERATIONAL AMPLIFIERS

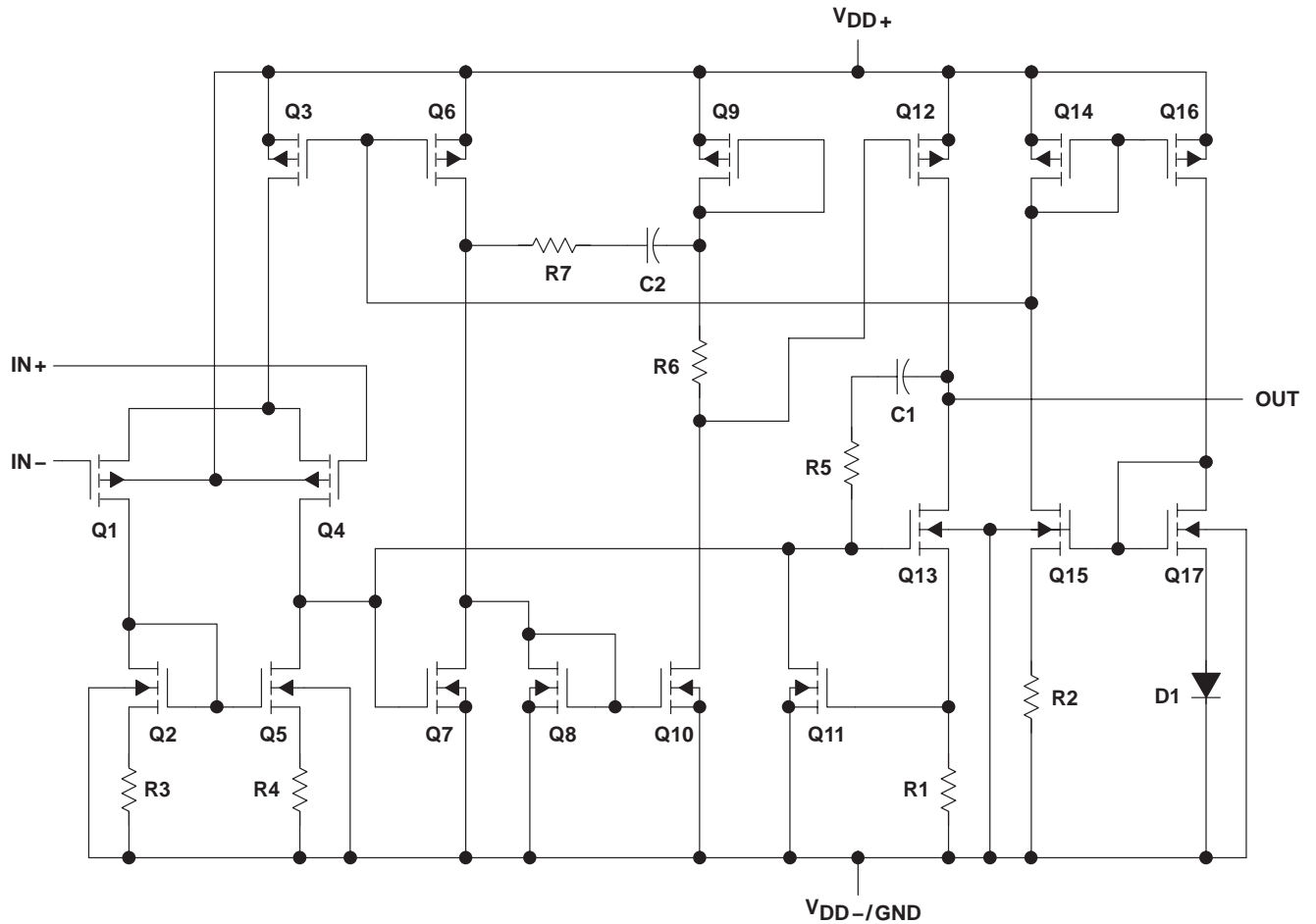
SLOS197A – AUGUST 1997 – REVISED MARCH 2001

#### TLV2721Y chip information

This chip, when properly assembled, displays characteristics similar to the TLV2721C. Thermal compression or ultrasonic bonding may be used on the doped-aluminum bonding pads. This chip may be mounted with conductive epoxy or a gold-silicon preform.



equivalent schematic



COMPONENT COUNT†	
Transistors	23
Diodes	5
Resistors	11
Capacitors	2

† Includes both amplifiers and all ESD, bias, and trim circuitry

**TLV2721, TLV2721Y**  
**Advanced LinCMOS™ RAIL-TO-RAIL**  
**VERY LOW-POWER SINGLE OPERATIONAL AMPLIFIERS**

SLOS197A – AUGUST 1997 – REVISED MARCH 2001

**absolute maximum ratings over operating free-air temperature range (unless otherwise noted)†**

Supply voltage, $V_{DD}$ (see Note 1)	12 V
Differential input voltage, $V_{ID}$ (see Note 2)	$\pm V_{DD}$
Input voltage range, $V_I$ (any input, see Note 1)	-0.3 V to $V_{DD}$
Input current, $I_I$ (each input)	$\pm 5$ mA
Output current, $I_O$	$\pm 50$ mA
Total current into $V_{DD+}$	$\pm 50$ mA
Total current out of $V_{DD-}$	$\pm 50$ mA
Duration of short-circuit current (at or below) 25°C (see Note 3)	unlimited
Continuous total power dissipation	See Dissipation Rating Table
Operating free-air temperature range, $T_A$ : TLV2721C	0°C to 70°C
TLV2721I	-40°C to 85°C
Storage temperature range, $T_{stg}$	-65°C to 150°C
Lead temperature 1,6 mm (1/16 inch) from case for 10 seconds: DBV package	260°C

† Stresses beyond those listed under “absolute maximum ratings” may cause permanent damage to the device. These are stress ratings only, and functional operation of the device at these or any other conditions beyond those indicated under “recommended operating conditions” is not implied. Exposure to absolute-maximum-rated conditions for extended periods may affect device reliability.

- NOTES:
1. All voltage values, except differential voltages, are with respect to  $V_{DD-}$ .
  2. Differential voltages are at the noninverting input with respect to the inverting input. Excessive current flows when input is brought below  $V_{DD-} - 0.3$  V.
  3. The output can be shorted to either supply. Temperature and/or supply voltages must be limited to ensure that the maximum dissipation rating is not exceeded.

**DISSIPATION RATING TABLE**

PACKAGE	$T_A \leq 25^\circ\text{C}$ POWER RATING	DERATING FACTOR ABOVE $T_A = 25^\circ\text{C}$	$T_A = 70^\circ\text{C}$ POWER RATING	$T_A = 85^\circ\text{C}$ POWER RATING
DBV	150 mW	1.2 mW/°C	96 mW	78 mW

**recommended operating conditions**

	TLV2721C		TLV2721I		UNIT
	MIN	MAX	MIN	MAX	
Supply voltage, $V_{DD}$ (see Note 1)	2.7	10	2.7	10	V
Input voltage range, $V_I$	$V_{DD-}$	$V_{DD+} - 1.3$	$V_{DD-}$	$V_{DD+} - 1.3$	V
Common-mode input voltage, $V_{IC}$	$V_{DD-}$	$V_{DD+} - 1.3$	$V_{DD-}$	$V_{DD+} - 1.3$	V
Operating free-air temperature, $T_A$	0	70	-40	85	°C

NOTE 1: All voltage values, except differential voltages, are with respect to  $V_{DD-}$ .



**TLV2721, TLV2721Y**  
**Advanced LinCMOS™ RAIL-TO-RAIL**  
**VERY LOW-POWER SINGLE OPERATIONAL AMPLIFIERS**  
 SLOS197A – AUGUST 1997 – REVISED MARCH 2001

electrical characteristics at specified free-air temperature,  $V_{DD} = 3\text{ V}$  (unless otherwise noted)

PARAMETER	TEST CONDITIONS	$T_A$ †	TLV2721C			TLV2721I			UNIT	
			MIN	TYP	MAX	MIN	TYP	MAX		
$V_{IO}$	Input offset voltage	Full range		0.5	3		0.5	3	mV	
$\alpha_{VIO}$	Temperature coefficient of input offset voltage			1			1		$\mu\text{V}/^\circ\text{C}$	
	Input offset voltage long-term drift (see Note 4)		25°C	0.003			0.003			$\mu\text{V}/\text{mo}$
$I_{IO}$	Input offset current		25°C		0.5	60		0.5	60	pA
			Full range		150		150			
$I_{IB}$	Input bias current		25°C		1	60		1	60	pA
		Full range		150		150				
$V_{ICR}$	Common-mode input voltage range	$R_S = 50\ \Omega$ , $ V_{IO}  \leq 5\text{ mV}$	25°C	0 to 2	-0.3 to 2.2	0 to 2	-0.3 to 2.2	V		
			Full range	0 to 1.7		0 to 1.7				
$V_{OH}$	High-level output voltage	$I_{OH} = -100\ \mu\text{A}$	25°C	2.97			2.97			V
			25°C	2.88			2.88			
			Full range	2.6			2.6			
$V_{OL}$	Low-level output voltage	$V_{IC} = 1.5\text{ V}$ , $I_{OL} = 50\ \mu\text{A}$	25°C	15			15			mV
			25°C	150			150			
			Full range	500			500			
$A_{VD}$	Large-signal differential voltage amplification	$V_{IC} = 1.5\text{ V}$ , $V_O = 1\text{ V to }2\text{ V}$	25°C	$R_L = 2\text{ k}\Omega^\ddagger$		2		3		V/mV
				$R_L = 1\text{ M}\Omega^\ddagger$		1		1		
			25°C	$R_L = 1\text{ M}\Omega^\ddagger$		250		250		
$r_{id}$	Differential input resistance		25°C	$10^{12}$			$10^{12}$			$\Omega$
$r_{ic}$	Common-mode input resistance		25°C	$10^{12}$			$10^{12}$			$\Omega$
$C_{ic}$	Common-mode input capacitance	$f = 10\text{ kHz}$	25°C	6			6			pF
$z_o$	Closed-loop output impedance	$f = 10\text{ kHz}$ , $A_V = 10$	25°C	90			90			$\Omega$
CMRR	Common-mode rejection ratio	$V_{IC} = 0\text{ to }1.7\text{ V}$ , $V_O = 1.5\text{ V}$ , $R_S = 50\ \Omega$	25°C	70	82	70	82	dB		
			Full range	65			65			
$k_{SVR}$	Supply voltage rejection ratio ( $\Delta V_{DD} / \Delta V_{IO}$ )	$V_{DD} = 2.7\text{ V to }8\text{ V}$ , $V_{IC} = V_{DD}/2$ , No load	25°C	80	95	80	95	dB		
			Full range	80			80			
$I_{DD}$	Supply current	$V_O = 1.5\text{ V}$ , No load	25°C	100	150	100	150	$\mu\text{A}$		
			Full range	200			200			

† Full range for the TLV2721C is 0°C to 70°C. Full range for the TLV2721I is -40°C to 85°C.

‡ Referenced to 1.5 V

NOTE 4: Typical values are based on the input offset voltage shift observed through 500 hours of operating life test at  $T_A = 150^\circ\text{C}$  extrapolated to  $T_A = 25^\circ\text{C}$  using the Arrhenius equation and assuming an activation energy of 0.96 eV.

**TLV2721, TLV2721Y**  
**Advanced LinCMOS™ RAIL-TO-RAIL**  
**VERY LOW-POWER SINGLE OPERATIONAL AMPLIFIERS**

SLOS197A – AUGUST 1997 – REVISED MARCH 2001

operating characteristics at specified free-air temperature,  $V_{DD} = 3\text{ V}$

PARAMETER	TEST CONDITIONS		$T_A$ †	TLV2721C			TLV2721I			UNIT	
				MIN	TYP	MAX	MIN	TYP	MAX		
SR	Slew rate at unity gain	$V_O = 1.1\text{ V to }1.9\text{ V}, R_L = 2\text{ k}\Omega^\ddagger, C_L = 100\text{ pF}^\ddagger$	25°C	0.1	0.25		0.1	0.25		V/ $\mu\text{s}$	
			Full range	0.05			0.05				
$V_n$	Equivalent input noise voltage	$f = 10\text{ Hz}$ $f = 1\text{ kHz}$	25°C	120			120			nV/ $\sqrt{\text{Hz}}$	
			25°C	20			20				
$V_{N(PP)}$	Peak-to-peak equivalent input noise voltage	$f = 0.1\text{ Hz to }1\text{ Hz}$ $f = 0.1\text{ Hz to }10\text{ Hz}$	25°C	680			680			mV	
			25°C	860			860				
$I_n$	Equivalent input noise current		25°C	0.6			0.6			fA/ $\sqrt{\text{Hz}}$	
THD+N	Total harmonic distortion plus noise	$V_O = 1\text{ V to }2\text{ V}, f = 20\text{ kHz}, R_L = 2\text{ k}\Omega^\ddagger$	25°C	$A_V = 1$	2.52%			2.52%			
				$A_V = 10$	7.01%			7.01%			
		$V_O = 1\text{ V to }2\text{ V}, f = 20\text{ kHz}, R_L = 2\text{ k}\Omega^\S$	25°C	$A_V = 1$	0.076%			0.076%			
				$A_V = 10$	0.147%			0.147%			
	Gain-bandwidth product	$f = 1\text{ kHz}, C_L = 100\text{ pF}^\ddagger, R_L = 2\text{ k}\Omega^\ddagger$	25°C	480			480			kHz	
BOM	Maximum output-swing bandwidth	$V_{O(PP)} = 1\text{ V}, R_L = 2\text{ k}\Omega^\ddagger, A_V = 1, C_L = 100\text{ pF}^\ddagger$	25°C	30			30			kHz	
$t_s$	Settling time	$A_V = -1, \text{ Step} = 1\text{ V to }2\text{ V}, R_L = 2\text{ k}\Omega^\ddagger, C_L = 100\text{ pF}^\ddagger$	25°C	4.5			4.5			$\mu\text{s}$	
			25°C	6.8			6.8			$\mu\text{s}$	
$\phi_m$	Phase margin at unity gain	$R_L = 2\text{ k}\Omega^\ddagger, C_L = 100\text{ pF}^\ddagger$	25°C	53°			53°				
	Gain margin		25°C	12			12			dB	

† Full range is  $-40^\circ\text{C}$  to  $85^\circ\text{C}$ .

‡ Referenced to 1.5 V

§ Referenced to 0 V



**TLV2721, TLV2721Y**  
**Advanced LinCMOS™ RAIL-TO-RAIL**  
**VERY LOW-POWER SINGLE OPERATIONAL AMPLIFIERS**  
 SLOS197A – AUGUST 1997 – REVISED MARCH 2001

electrical characteristics at specified free-air temperature,  $V_{DD} = 5\text{ V}$  (unless otherwise noted)

PARAMETER	TEST CONDITIONS	$T_A$ †	TLV2721C			TLV2721I			UNIT
			MIN	TYP	MAX	MIN	TYP	MAX	
$V_{IO}$ Input offset voltage	$V_{DD\pm} = \pm 2.5\text{ V}$ , $V_O = 0$ , $V_{IC} = 0$ , $R_S = 50\ \Omega$	Full range	0.5		3	0.5		3	mV
$\alpha_{VIO}$ Temperature coefficient of input offset voltage			1		1	$\mu\text{V}/^\circ\text{C}$			
Input offset voltage long-term drift (see Note 4)		25°C	0.003		0.003	$\mu\text{V}/\text{mo}$			
$I_{IO}$ Input offset current		25°C	0.5		60	0.5		60	pA
		Full range	150		150				
$I_{IB}$ Input bias current		25°C	1		60	1		60	pA
	Full range	150		150					
$V_{ICR}$ Common-mode input voltage range	$R_S = 50\ \Omega$ , $ V_{IO}  \leq 5\text{ mV}$	25°C	0 to 4	-0.3 to 4.2	0 to 4	-0.3 to 4.2	V		
		Full range	0 to 3.5		0 to 3.5				
$V_{OH}$ High-level output voltage	$I_{OH} = -500\ \mu\text{A}$ $I_{OH} = -1\text{ mA}$	25°C	4.75	4.88	4.75	4.88	V		
		25°C	4.6	4.76	4.6	4.76			
$V_{OL}$ Low-level output voltage	$V_{IC} = 2.5\text{ V}$ , $I_{OL} = 50\ \mu\text{A}$ $V_{IC} = 2.5\text{ V}$ , $I_{OL} = 500\ \mu\text{A}$	25°C	12		12		mV		
		25°C	120		120				
		Full range	500		500				
$A_{VD}$ Large-signal differential voltage amplification	$V_{IC} = 2.5\text{ V}$ , $V_O = 1\text{ V to } 4\text{ V}$	$R_L = 2\text{ k}\Omega$ ‡	25°C	3	5	3	5	V/mV	
			Full range	1		1			
		$R_L = 1\text{ M}\Omega$ ‡	25°C	800		800			
$r_{id}$ Differential input resistance		25°C	$10^{12}$		$10^{12}$	$\Omega$			
$r_{ic}$ Common-mode input resistance		25°C	$10^{12}$		$10^{12}$	$\Omega$			
$c_{ic}$ Common-mode input capacitance	$f = 10\text{ kHz}$	25°C	6		6	pF			
$z_o$ Closed-loop output impedance	$f = 10\text{ kHz}$ , $A_V = 10$	25°C	70		70	$\Omega$			
CMRR Common-mode rejection ratio	$V_{IC} = 0\text{ to } 2.7\text{ V}$ , $V_O = 1.5\text{ V}$ , $R_S = 50\ \Omega$	25°C	70	85	70	85	dB		
		Full range	65		65				
$k_{SVR}$ Supply voltage rejection ratio ( $\Delta V_{DD} / \Delta V_{IO}$ )	$V_{DD} = 4.4\text{ V to } 8\text{ V}$ , $V_{IC} = V_{DD}/2$ , No load	25°C	80	95	80	95	dB		
		Full range	80		80				
$I_{DD}$ Supply current	$V_O = 2.5\text{ V}$ , No load	25°C	110	150	110	150	$\mu\text{A}$		
		Full range	200		200				

† Full range for the TLV2721C is 0°C to 70°C. Full range for the TLV2721I is -40°C to 85°C.

‡ Referenced to 2.5 V

NOTE 5: Typical values are based on the input offset voltage shift observed through 500 hours of operating life test at  $T_A = 150^\circ\text{C}$  extrapolated to  $T_A = 25^\circ\text{C}$  using the Arrhenius equation and assuming an activation energy of 0.96 eV.

**TLV2721, TLV2721Y**  
**Advanced LinCMOS™ RAIL-TO-RAIL**  
**VERY LOW-POWER SINGLE OPERATIONAL AMPLIFIERS**

SLOS197A – AUGUST 1997 – REVISED MARCH 2001

operating characteristics at specified free-air temperature,  $V_{DD} = 5\text{ V}$

PARAMETER	TEST CONDITIONS	$T_A$ †	TLV2721C			TLV2721I			UNIT	
			MIN	TYP	MAX	MIN	TYP	MAX		
SR	Slew rate at unity gain $V_O = 1.5\text{ V to }3.5\text{ V}$ , $R_L = 2\text{ k}\Omega$ ‡, $C_L = 100\text{ pF}$ ‡	25°C	0.1	0.25		0.1	0.25		V/ $\mu$ s	
		Full range	0.05			0.05				
$V_n$	Equivalent input noise voltage $f = 10\text{ Hz}$ $f = 1\text{ kHz}$	25°C	90			90			nV/ $\sqrt{\text{Hz}}$	
		25°C	19			19				
$V_{N(PP)}$	Peak-to-peak equivalent input noise voltage $f = 0.1\text{ Hz to }1\text{ Hz}$ $f = 0.1\text{ Hz to }10\text{ Hz}$	25°C	800			800			mV	
		25°C	960			960				
$I_n$	Equivalent input noise current	25°C	0.6			0.6			fA/ $\sqrt{\text{Hz}}$	
THD+N	$V_O = 1.5\text{ V to }3.5\text{ V}$ , $f = 20\text{ kHz}$ , $R_L = 2\text{ k}\Omega$ ‡	25°C	$A_V = 1$	2.45%			2.45%			
			$A_V = 10$	5.54%			5.54%			
	$V_O = 1.5\text{ V to }3.5\text{ V}$ , $f = 20\text{ kHz}$ , $R_L = 2\text{ k}\Omega$ §	25°C	$A_V = 1$	0.142%			0.142%			
			$A_V = 10$	0.257%			0.257%			
Gain-bandwidth product	$f = 1\text{ kHz}$ , $C_L = 100\text{ pF}$ ‡, $R_L = 2\text{ k}\Omega$ ‡	25°C	510			510			kHz	
BOM	Maximum output-swinging bandwidth $V_{O(PP)} = 1\text{ V}$ , $R_L = 2\text{ k}\Omega$ ‡, $A_V = 1$ , $C_L = 100\text{ pF}$ ‡	25°C	40			40			kHz	
$t_s$	Settling time $A_V = -1$ , Step = 1.5 V to 3.5 V, $R_L = 2\text{ k}\Omega$ ‡, $C_L = 100\text{ pF}$ ‡	25°C	6.8			6.8			$\mu$ s	
		25°C	9.2			9.2				
$\phi_m$	Phase margin at unity gain $R_L = 2\text{ k}\Omega$ ‡, $C_L = 100\text{ pF}$ ‡	25°C	53°			53°				
		25°C	12			12				
	Gain margin	25°C	12			12			dB	

† Full range is  $-40^\circ\text{C}$  to  $85^\circ\text{C}$ .

‡ Referenced to 2.5 V

§ Referenced to 0 V





**TLV2721, TLV2721Y**  
**Advanced LinCMOS™ RAIL-TO-RAIL**  
**VERY LOW-POWER SINGLE OPERATIONAL AMPLIFIERS**  
 SLOS197A – AUGUST1997 – REVISED MARCH 2001

electrical characteristics at  $V_{DD} = 3\text{ V}$ ,  $T_A = 25^\circ\text{C}$  (unless otherwise noted)

PARAMETER	TEST CONDITIONS	TLV2721Y			UNIT
		MIN	TYP	MAX	
$V_{IO}$ Input offset voltage	$V_{DD} \pm \pm 1.5\text{ V}$ , $R_S = 50\ \Omega$	620			$\mu\text{V}$
$I_{IO}$ Input offset current		0.5 60			$\text{pA}$
$I_{IB}$ Input bias current		1 60			$\text{pA}$
$V_{ICR}$ Common-mode input voltage range	$ V_{IO}  \leq 5\text{ mV}$ , $R_S = 50\ \Omega$	-0.3 to 2.2			$\text{V}$
$V_{OH}$ High-level output voltage	$I_{OH} = -100\ \mu\text{A}$	2.97			$\text{V}$
$V_{OL}$ Low-level output voltage	$V_{IC} = 1.5\text{ V}$ , $I_{OL} = 50\ \mu\text{A}$	15			$\text{mV}$
	$V_{IC} = 1.5\text{ V}$ , $I_{OL} = 500\ \mu\text{A}$	150			
$A_{VD}$ Large-signal differential voltage amplification	$V_O = 1\text{ V to } 2\text{ V}$	$R_L = 2\text{ k}\Omega^\dagger$	3		$\text{V/mV}$
		$R_L = 1\text{ M}\Omega^\dagger$	250		
$r_{id}$ Differential input resistance		$10^{12}$			$\Omega$
$r_{ic}$ Common-mode input resistance		$10^{12}$			$\Omega$
$c_{ic}$ Common-mode input capacitance	$f = 10\text{ kHz}$	6			$\text{pF}$
$z_o$ Closed-loop output impedance	$f = 10\text{ kHz}$ , $A_V = 10$	90			$\Omega$
CMRR Common-mode rejection ratio	$V_{IC} = 0\text{ to } 1.7\text{ V}$ , $V_O = 0$ , $R_S = 50\ \Omega$	82			$\text{dB}$
$k_{SVR}$ Supply voltage rejection ratio ( $\Delta V_{DD}/\Delta V_{IO}$ )	$V_{DD} = 2.7\text{ V to } 8\text{ V}$ , $V_{IC} = 0$ , No load	95			$\text{dB}$
$I_{DD}$ Supply current	$V_O = 0$ , No load	100			$\mu\text{A}$

$^\dagger$  Referenced to 1.5 V

electrical characteristics at  $V_{DD} = 5\text{ V}$ ,  $T_A = 25^\circ\text{C}$  (unless otherwise noted)

PARAMETER	TEST CONDITIONS	TLV2721Y			UNIT
		MIN	TYP	MAX	
$V_{IO}$ Input offset voltage	$V_{DD} \pm \pm 1.5\text{ V}$ , $R_S = 50\ \Omega$	610			$\mu\text{V}$
$I_{IO}$ Input offset current		0.5 60			$\text{pA}$
$I_{IB}$ Input bias current		1 60			$\text{pA}$
$V_{ICR}$ Common-mode input voltage range	$ V_{IO}  \leq 5\text{ mV}$ , $R_S = 50\ \Omega$	-0.3 to 4.2			$\text{V}$
$V_{OH}$ High-level output voltage	$I_{OH} = -500\ \mu\text{A}$	4.88			$\text{V}$
$V_{OL}$ Low-level output voltage	$V_{IC} = 2.5\text{ V}$ , $I_{OL} = 50\ \mu\text{A}$	12			$\text{mV}$
	$V_{IC} = 2.5\text{ V}$ , $I_{OL} = 500\ \mu\text{A}$	120			
$A_{VD}$ Large-signal differential voltage amplification	$V_O = 1\text{ V to } 4\text{ V}$	$R_L = 2\text{ k}\Omega^\dagger$	5		$\text{V/mV}$
		$R_L = 1\text{ M}\Omega^\dagger$	800		
$r_{id}$ Differential input resistance		$10^{12}$			$\Omega$
$r_{ic}$ Common-mode input resistance		$10^{12}$			$\Omega$
$c_{ic}$ Common-mode input capacitance	$f = 10\text{ kHz}$	6			$\text{pF}$
$z_o$ Closed-loop output impedance	$f = 10\text{ kHz}$ , $A_V = 10$	70			$\Omega$
CMRR Common-mode rejection ratio	$V_{IC} = 0\text{ to } 1.7\text{ V}$ , $V_O = 0$ , $R_S = 50\ \Omega$	85			$\text{dB}$
$k_{SVR}$ Supply voltage rejection ratio ( $\Delta V_{DD}/\Delta V_{IO}$ )	$V_{DD} = 2.7\text{ V to } 8\text{ V}$ , $V_{IC} = 0$ , No load	95			$\text{dB}$
$I_{DD}$ Supply current	$V_O = 0$ , No load	110			$\mu\text{A}$

$^\dagger$  Referenced to 2.5 V

**TLV2721, TLV2721Y**  
**Advanced LinCMOS™ RAIL-TO-RAIL**  
**VERY LOW-POWER SINGLE OPERATIONAL AMPLIFIERS**  
 SLOS197A – AUGUST 1997 – REVISED MARCH 2001

**TYPICAL CHARACTERISTICS**

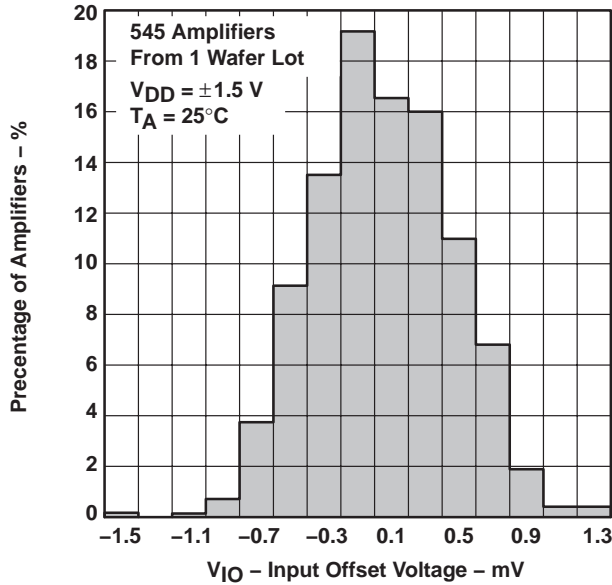
**Table of Graphs**

		<b>FIGURE</b>	
$V_{IO}$	Input offset voltage	Distribution vs Common-mode input voltage	1, 2 3, 4
$\alpha V_{IO}$	Input offset voltage temperature coefficient	Distribution	5, 6
$I_{IB}/I_{IO}$	Input bias and input offset currents	vs Free-air temperature	7
$V_I$	Input voltage	vs Supply voltage vs Free-air temperature	8 9
$V_{OH}$	High-level output voltage	vs High-level output current	10, 13
$V_{OL}$	Low-level output voltage	vs Low-level output current	11, 12, 14
$V_{O(PP)}$	Maximum peak-to-peak output voltage	vs Frequency	15
$I_{OS}$	Short-circuit output current	vs Supply voltage vs Free-air temperature	16 17
$V_O$	Output voltage	vs Differential input voltage	18, 19
$A_{VD}$	Differential voltage amplification	vs Load resistance	20
$A_{VD}$	Large signal differential voltage amplification	vs Frequency vs Free-air temperature	21, 22 23, 24
$z_o$	Output impedance	vs Frequency	25, 26
CMRR	Common-mode rejection ratio	vs Frequency vs Free-air temperature	27 28
$k_{SVR}$	Supply-voltage rejection ratio	vs Frequency vs Free-air temperature	29, 30 31
$I_{DD}$	Supply current	vs Supply voltage	32
SR	Slew rate	vs Load capacitance vs Free-air temperature	33 34
$V_O$	Inverting large-signal pulse response		35, 36
$V_O$	Voltage-follower large-signal pulse response		37, 38
$V_O$	Inverting small-signal pulse response		39, 40
$V_O$	Voltage-follower small-signal pulse response		41, 42
$V_n$	Equivalent input noise voltage	vs Frequency	43, 44
	Input noise voltage (referred to input)	Over a 10-second period	45
THD + N	Total harmonic distortion plus noise	vs Frequency	46
	Gain-bandwidth product	vs Free-air temperature vs Supply voltage	47 48
$\phi_m$	Phase margin	vs Frequency vs Load capacitance	21, 22 51, 52
	Gain margin	vs Load capacitance	49, 50
$B_1$	Unity-gain bandwidth	vs Load capacitance	53, 54

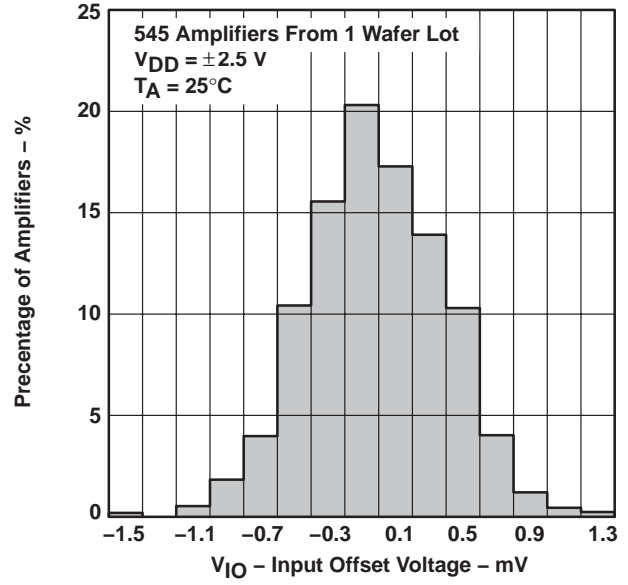


**TYPICAL CHARACTERISTICS**

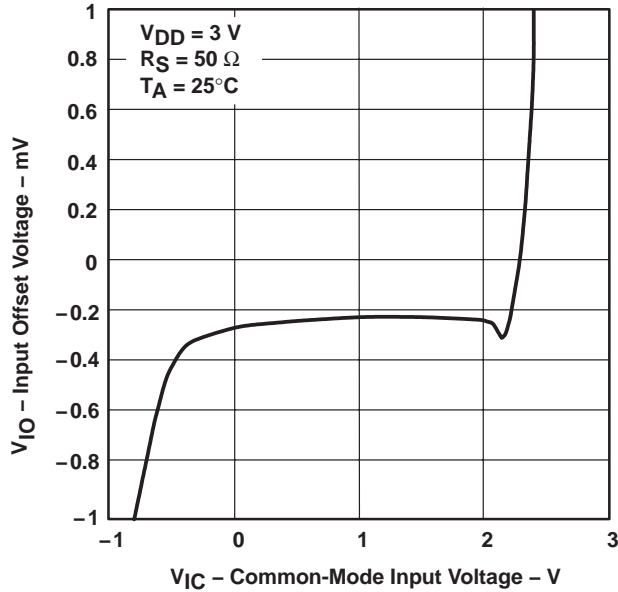
**DISTRIBUTION OF TLV2721  
INPUT OFFSET VOLTAGE**



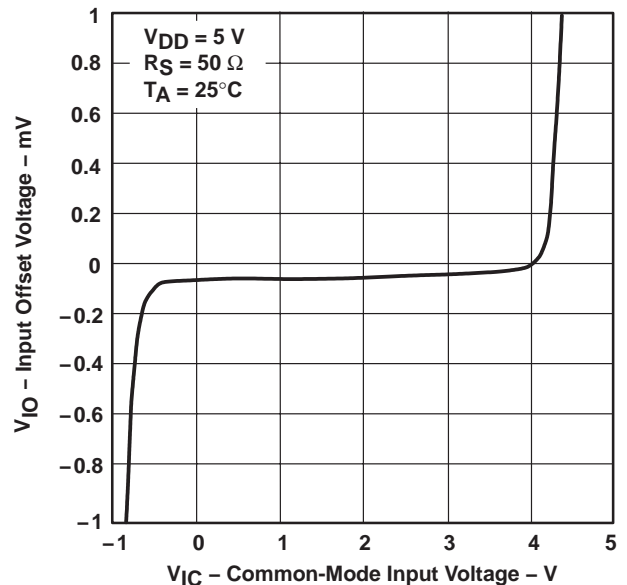
**DISTRIBUTION OF TLV2721  
INPUT OFFSET VOLTAGE**



**INPUT OFFSET VOLTAGE†  
vs  
COMMON-MODE INPUT VOLTAGE**

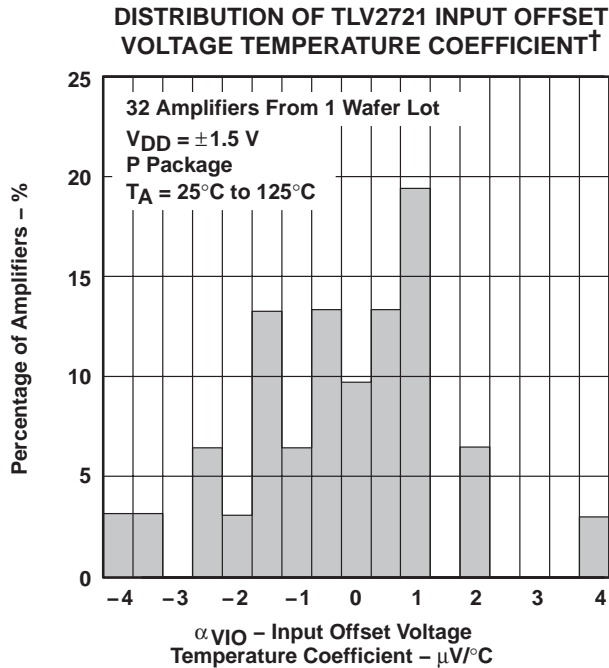


**INPUT OFFSET VOLTAGE†  
vs  
COMMON-MODE INPUT VOLTAGE**

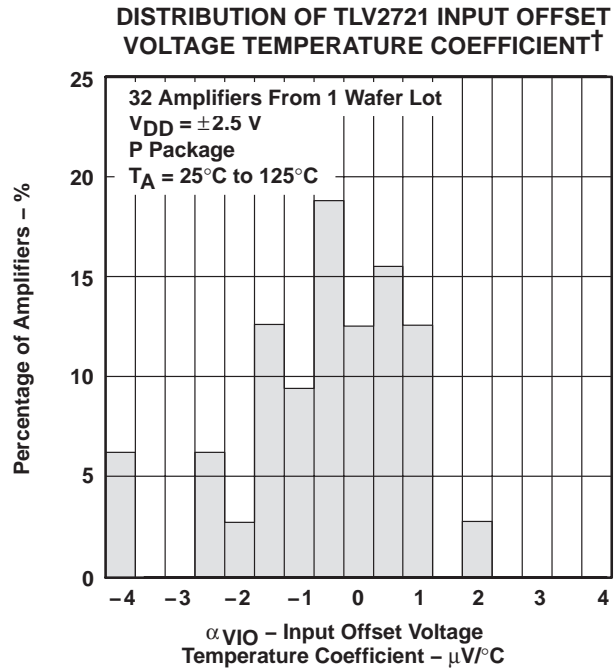


† For all curves where  $V_{DD} = 5\text{ V}$ , all loads are referenced to 2.5 V. For all curves where  $V_{DD} = 3\text{ V}$ , all loads are referenced to 1.5 V.

**TYPICAL CHARACTERISTICS**

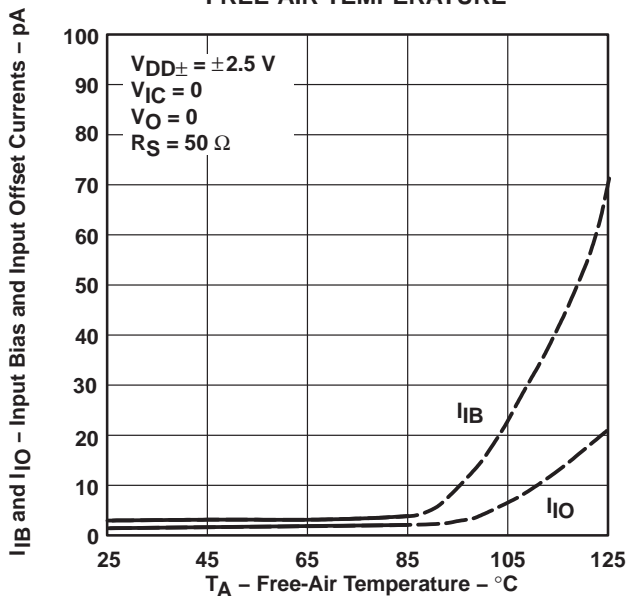


**Figure 5**



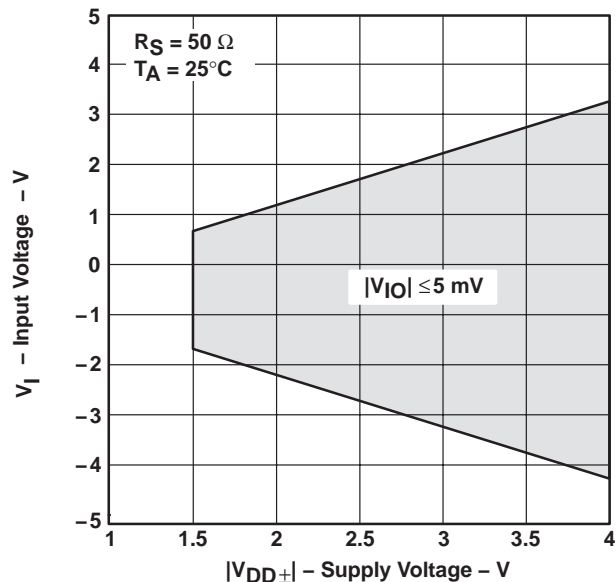
**Figure 6**

**INPUT BIAS AND INPUT OFFSET CURRENTS**  
**vs**  
**FREE-AIR TEMPERATURE**



**Figure 7**

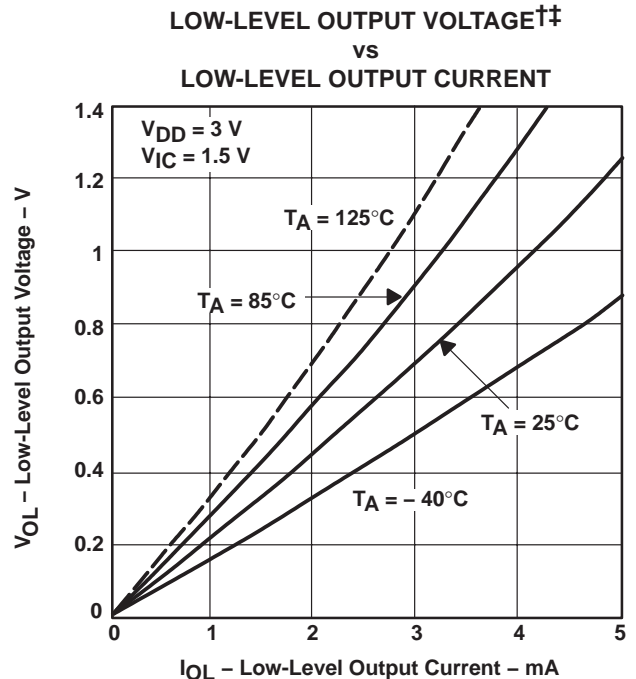
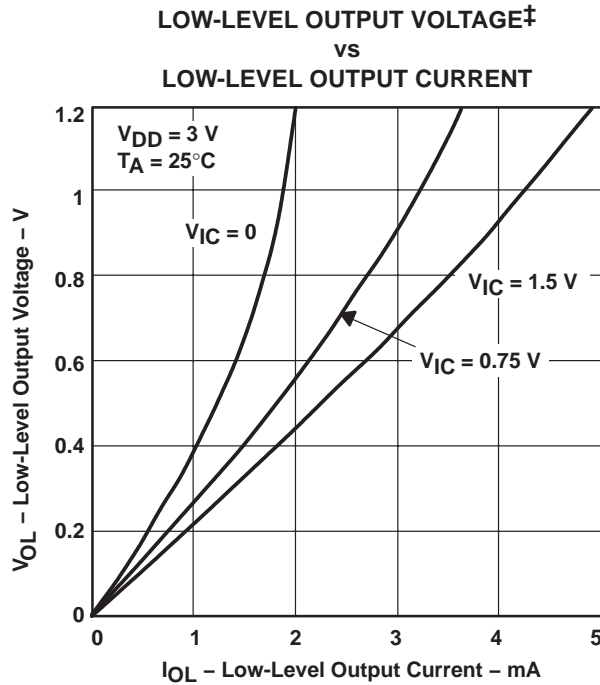
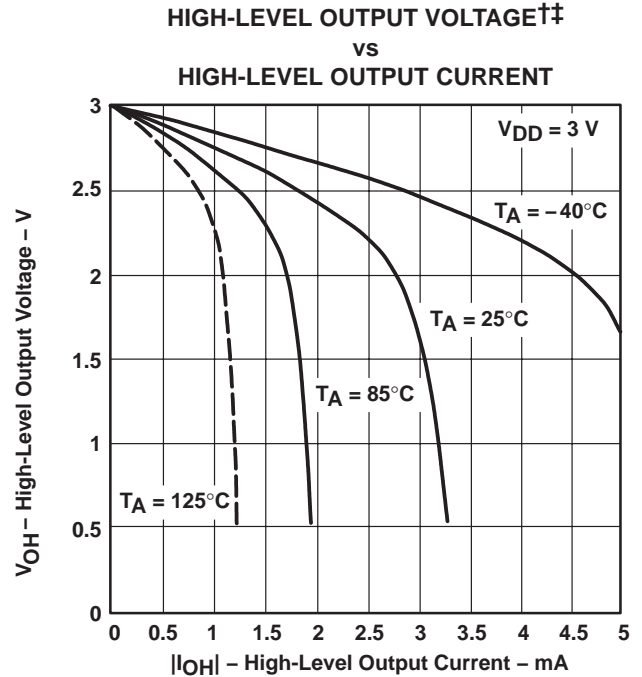
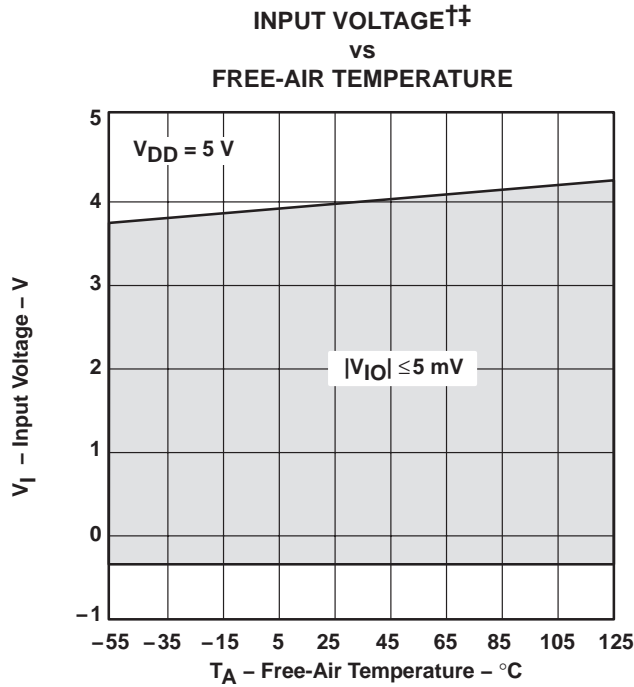
**INPUT VOLTAGE**  
**vs**  
**SUPPLY VOLTAGE**



**Figure 8**

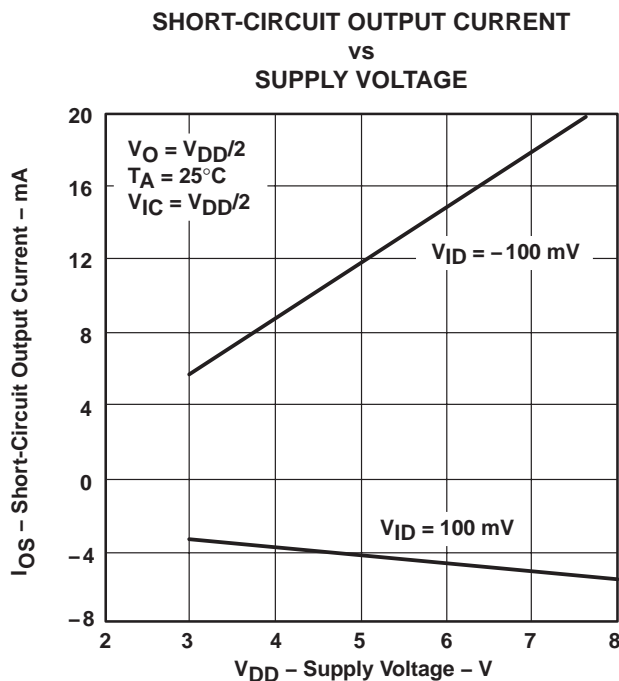
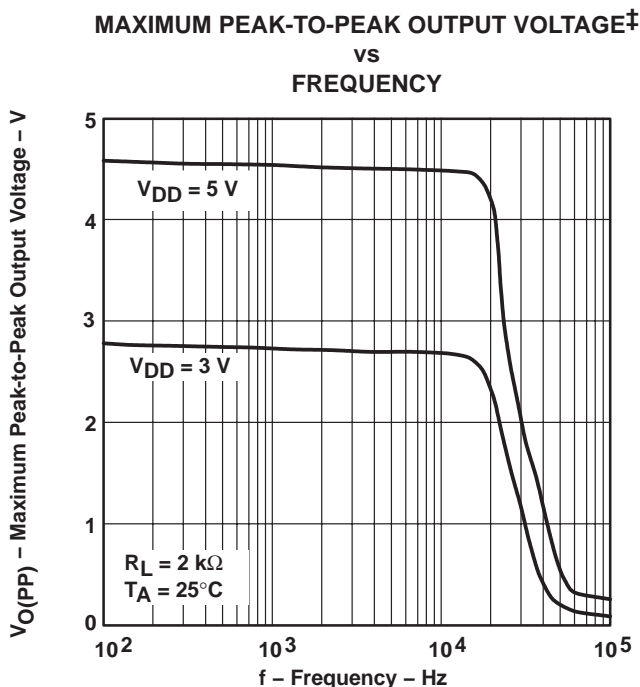
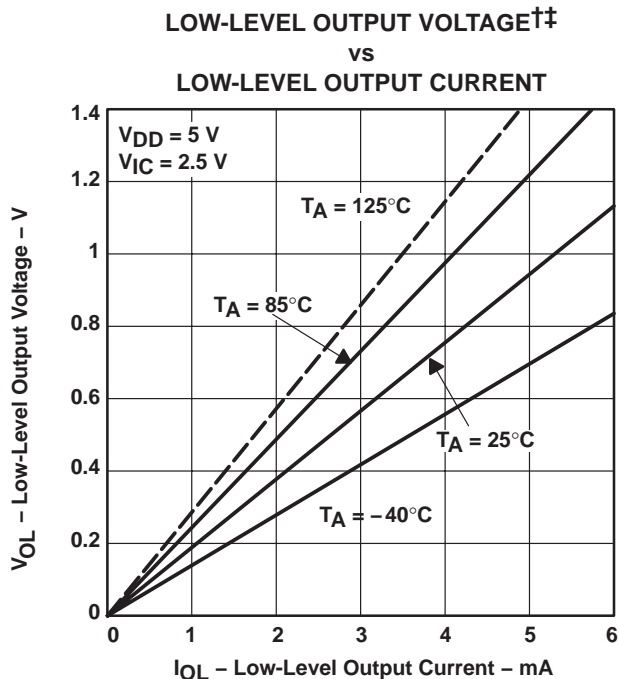
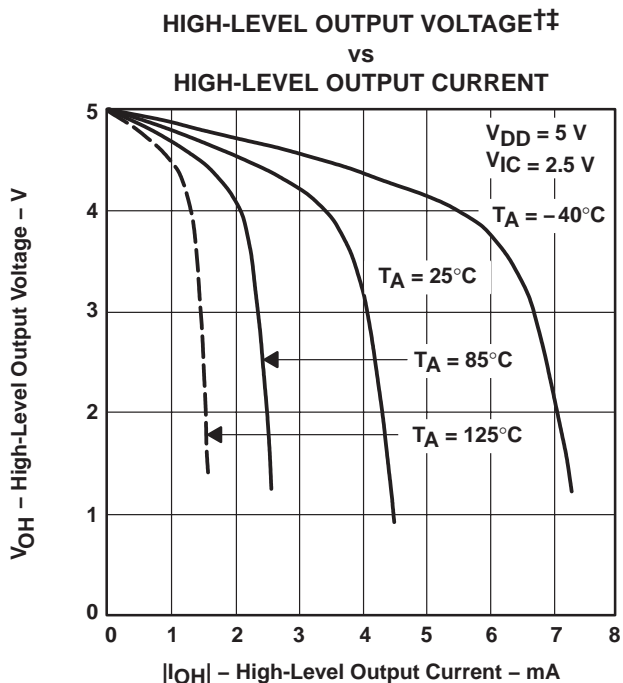
† Data at high and low temperatures are applicable only within the rated operating free-air temperature ranges of the various devices.

**TYPICAL CHARACTERISTICS**



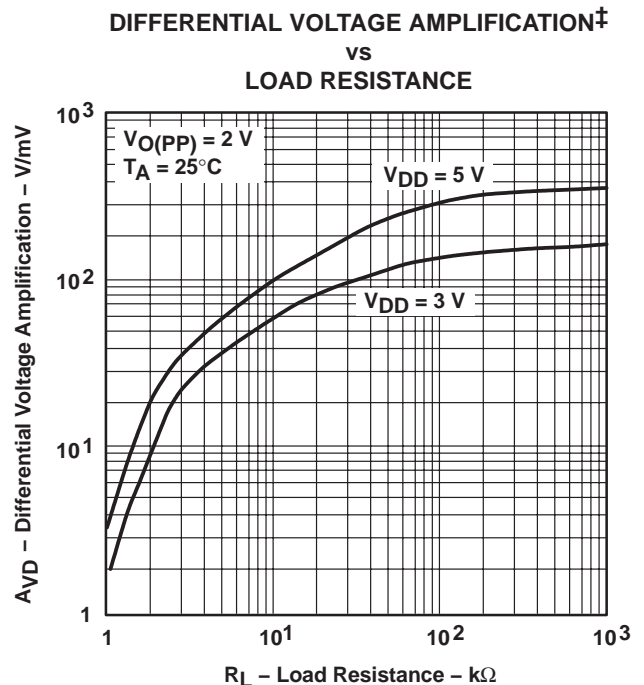
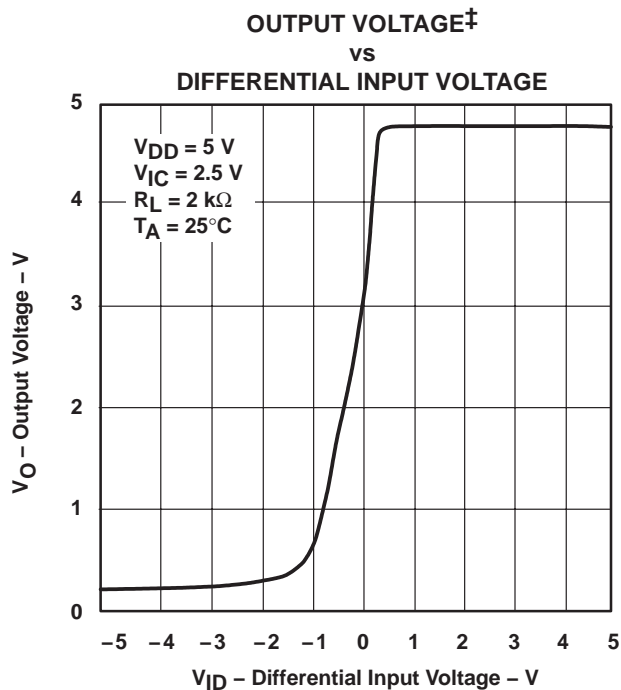
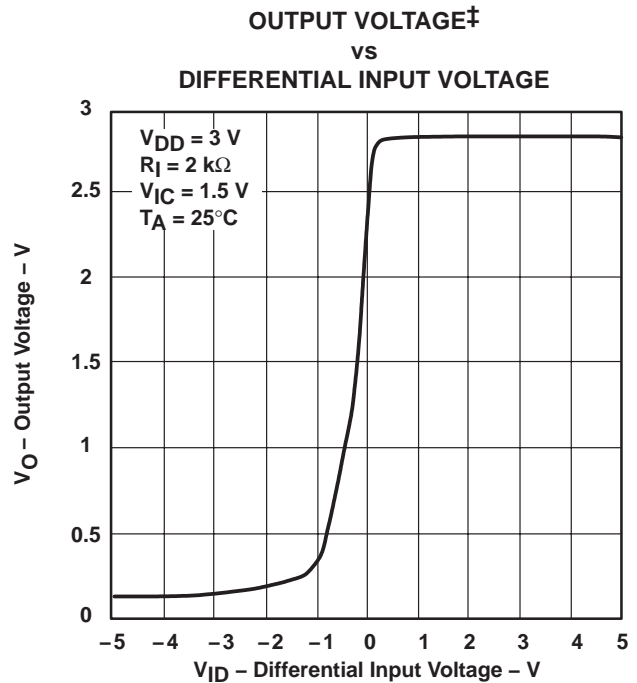
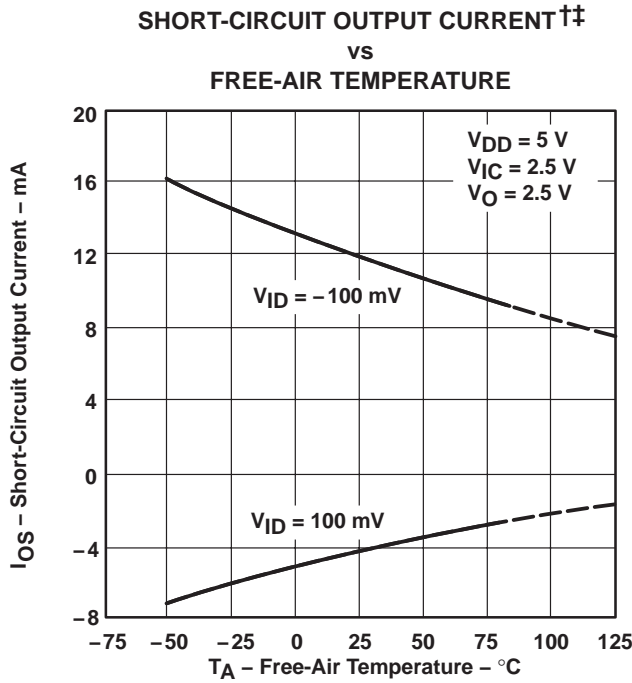
† Data at high and low temperatures are applicable only within the rated operating free-air temperature ranges of the various devices.  
 †† For all curves where  $V_{DD} = 5\text{ V}$ , all loads are referenced to 2.5 V. For all curves where  $V_{DD} = 3\text{ V}$ , all loads are referenced to 1.5 V.

**TYPICAL CHARACTERISTICS**



† Data at high and low temperatures are applicable only within the rated operating free-air temperature ranges of the various devices.  
 ‡ For all curves where  $V_{DD} = 5\text{ V}$ , all loads are referenced to 2.5 V. For all curves where  $V_{DD} = 3\text{ V}$ , all loads are referenced to 1.5 V.

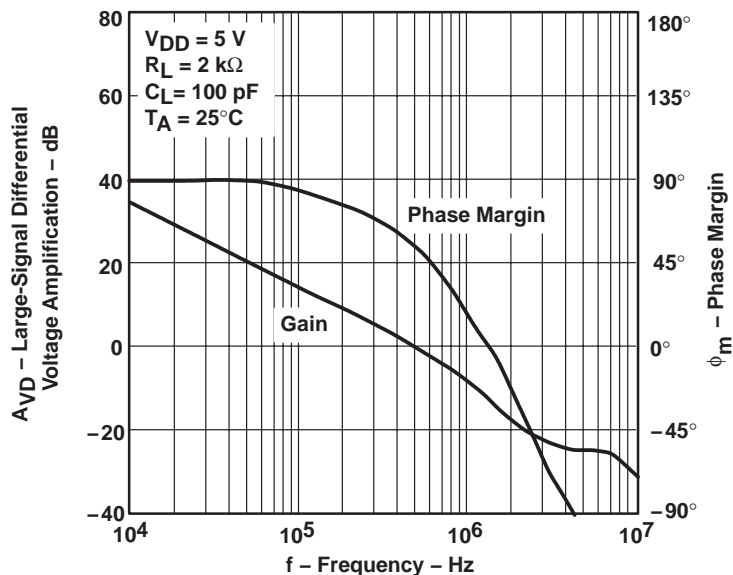
**TYPICAL CHARACTERISTICS**



† Data at high and low temperatures are applicable only within the rated operating free-air temperature ranges of the various devices.  
 †† For all curves where  $V_{DD} = 5\text{ V}$ , all loads are referenced to 2.5 V. For all curves where  $V_{DD} = 3\text{ V}$ , all loads are referenced to 1.5 V.

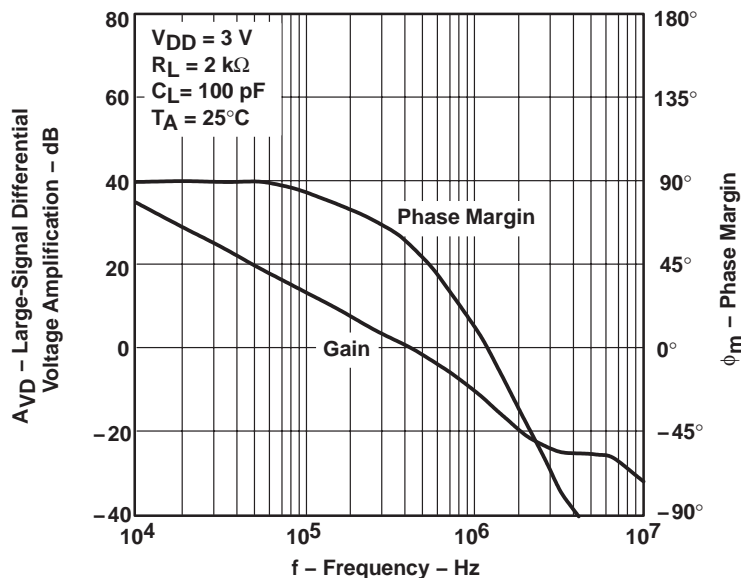
**TYPICAL CHARACTERISTICS**

**LARGE-SIGNAL DIFFERENTIAL VOLTAGE†  
 AMPLIFICATION AND PHASE MARGIN  
 VS  
 FREQUENCY**



**Figure 21**

**LARGE-SIGNAL DIFFERENTIAL VOLTAGE  
 AMPLIFICATION AND PHASE MARGIN†  
 VS  
 FREQUENCY**



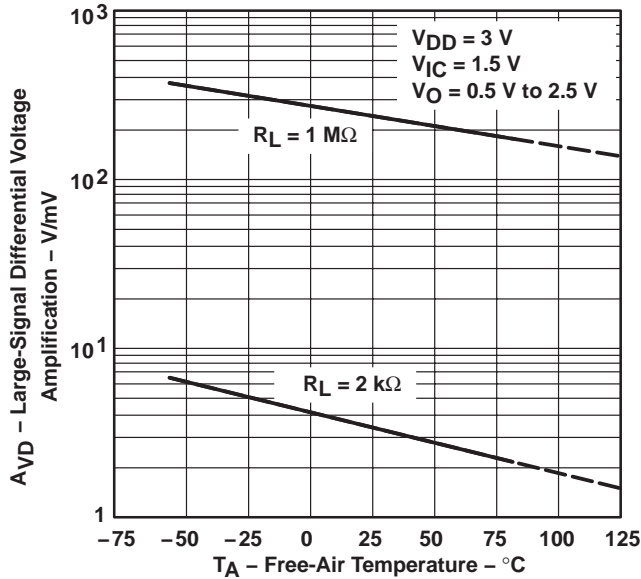
**Figure 22**

† For all curves where  $V_{DD} = 5\text{ V}$ , all loads are referenced to 2.5 V. For all curves where  $V_{DD} = 3\text{ V}$ , all loads are referenced to 1.5 V.

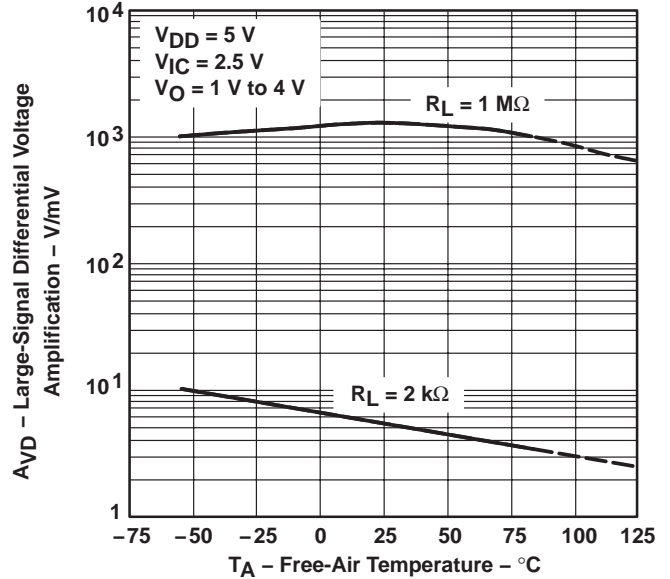


**TYPICAL CHARACTERISTICS**

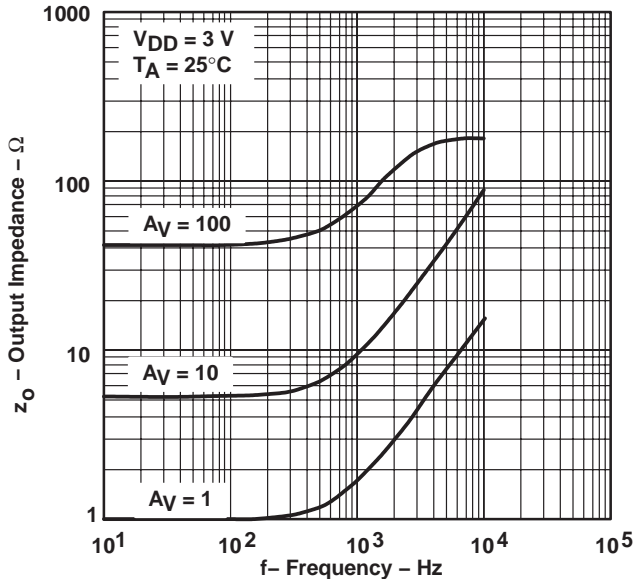
**LARGE-SIGNAL DIFFERENTIAL  
 VOLTAGE AMPLIFICATION†‡**  
 vs  
**FREE-AIR TEMPERATURE**



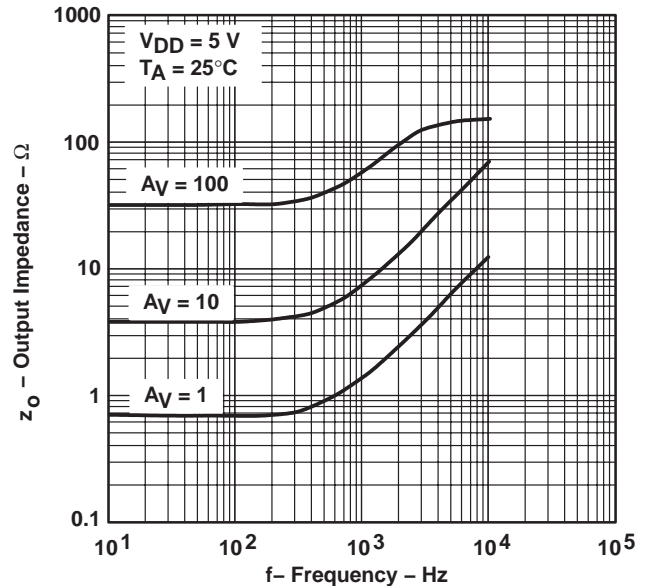
**LARGE-SIGNAL DIFFERENTIAL  
 VOLTAGE AMPLIFICATION†‡**  
 vs  
**FREE-AIR TEMPERATURE**



**OUTPUT IMPEDANCE‡**  
 vs  
**FREQUENCY**

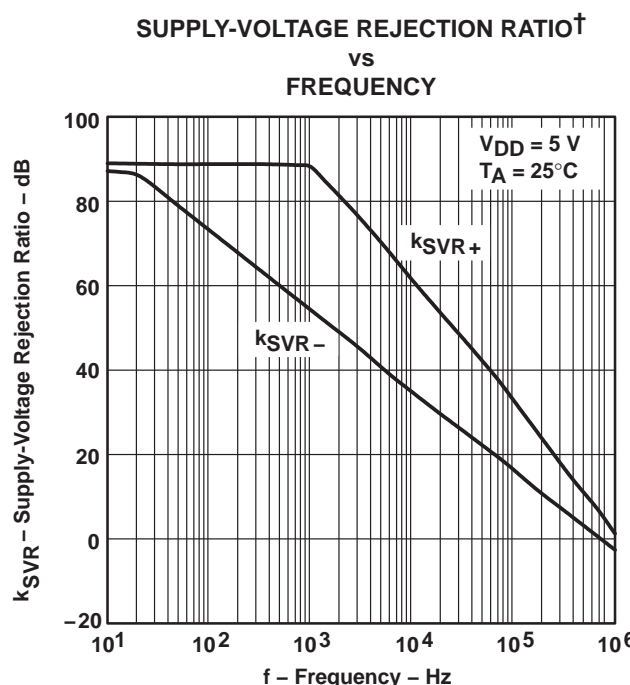
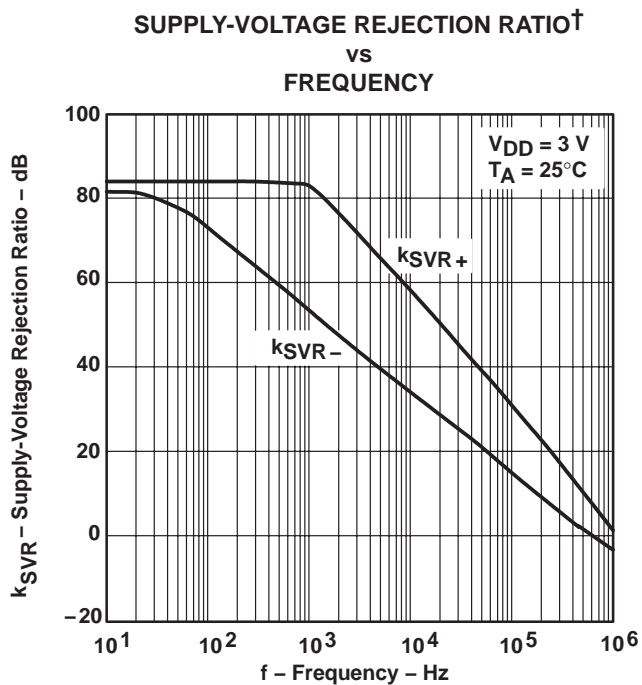
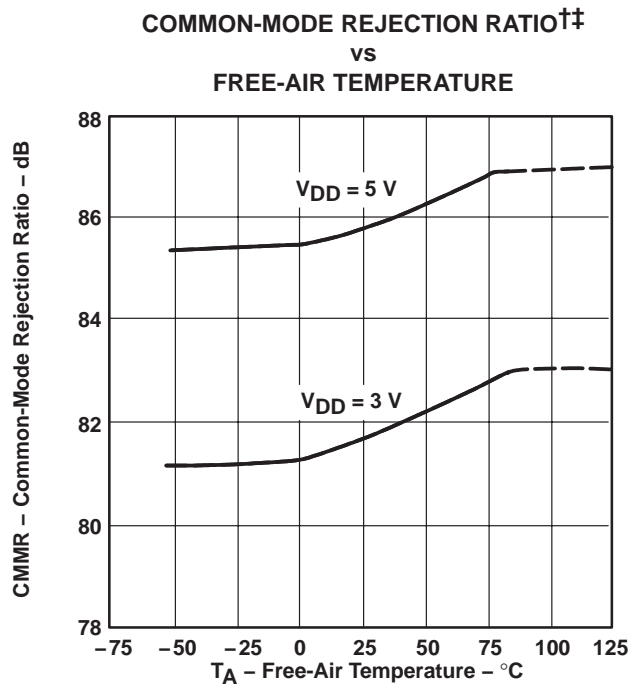
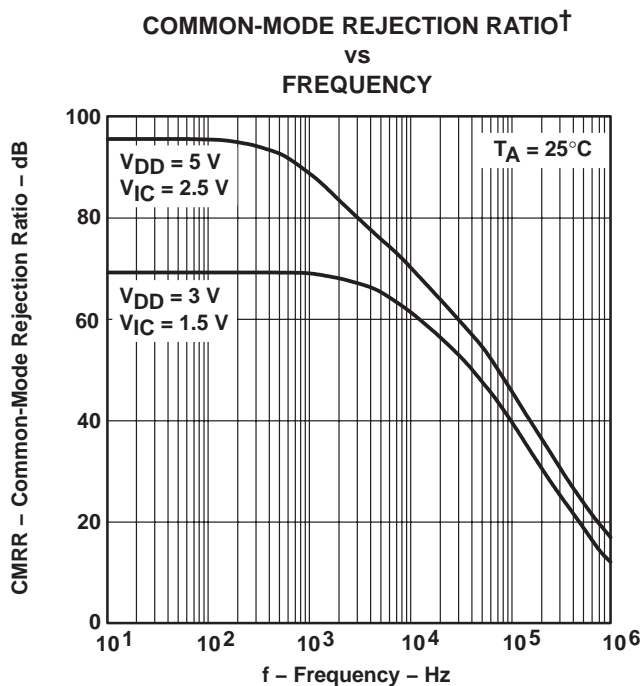


**OUTPUT IMPEDANCE‡**  
 vs  
**FREQUENCY**



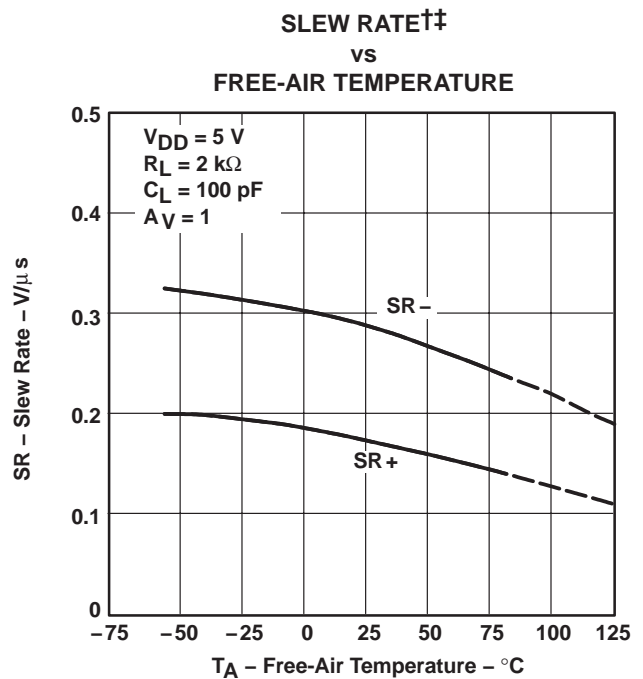
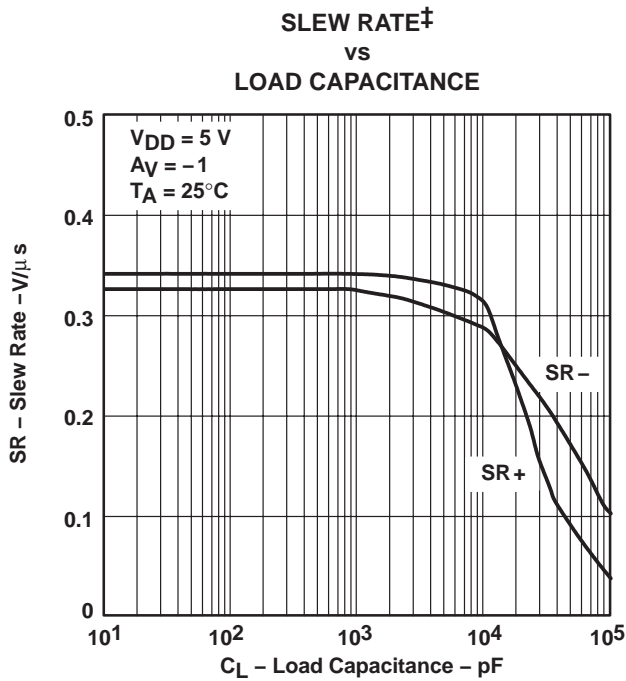
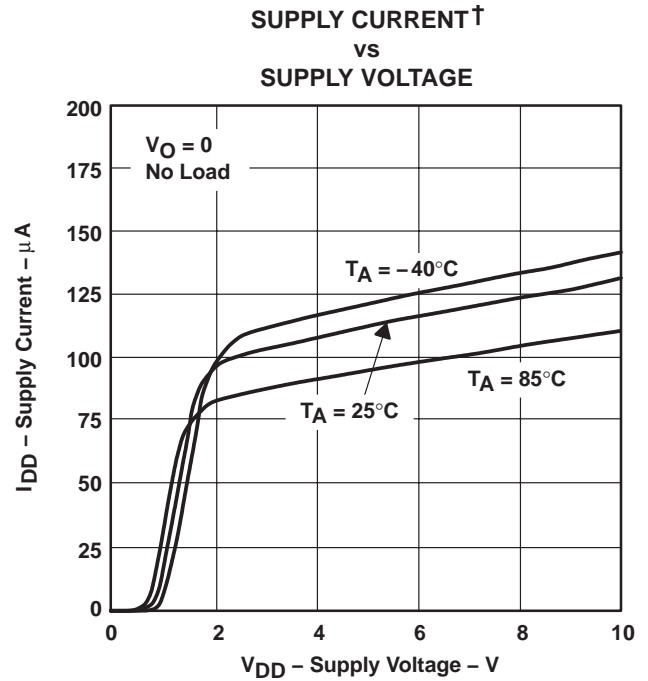
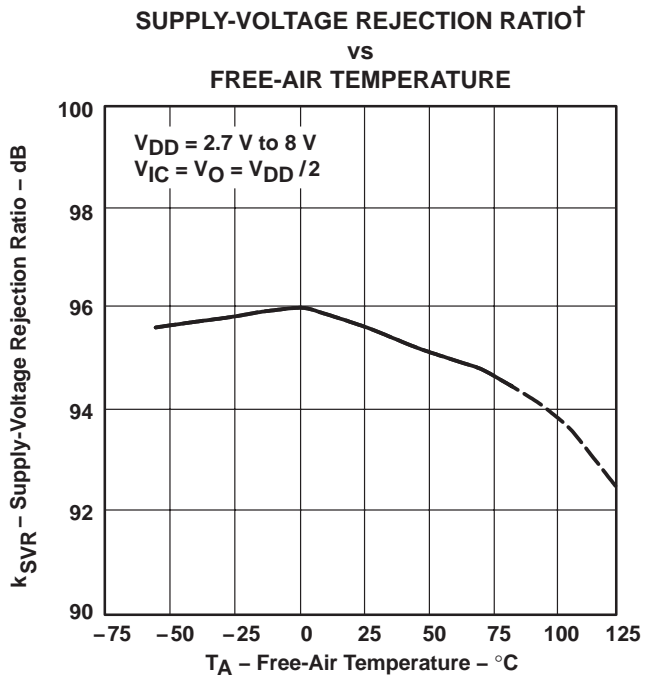
† Data at high and low temperatures are applicable only within the rated operating free-air temperature ranges of the various devices.  
 ‡ For all curves where  $V_{DD} = 5\text{ V}$ , all loads are referenced to 2.5 V. For all curves where  $V_{DD} = 3\text{ V}$ , all loads are referenced to 1.5 V.

**TYPICAL CHARACTERISTICS**



† For all curves where  $V_{DD} = 5\text{ V}$ , all loads are referenced to 2.5 V. For all curves where  $V_{DD} = 3\text{ V}$ , all loads are referenced to 1.5 V.  
 †† Data at high and low temperatures are applicable only within the rated operating free-air temperature ranges of the various devices.

**TYPICAL CHARACTERISTICS**

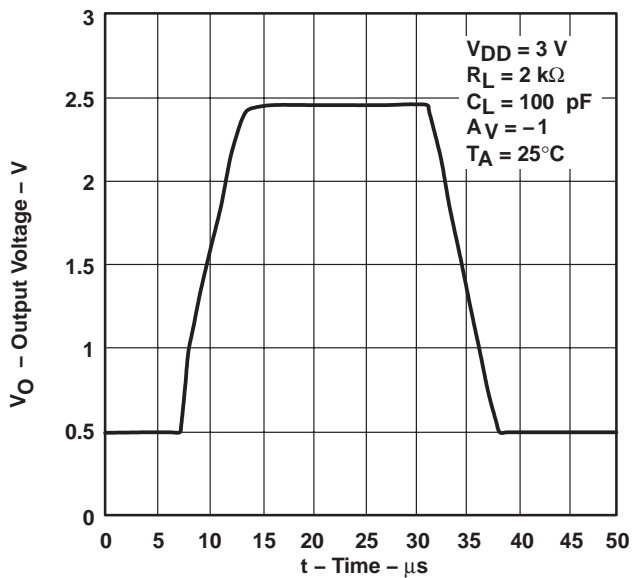


† Data at high and low temperatures are applicable only within the rated operating free-air temperature ranges of the various devices.

‡ For all curves where  $V_{DD} = 5\text{ V}$ , all loads are referenced to 2.5 V. For all curves where  $V_{DD} = 3\text{ V}$ , all loads are referenced to 1.5 V.

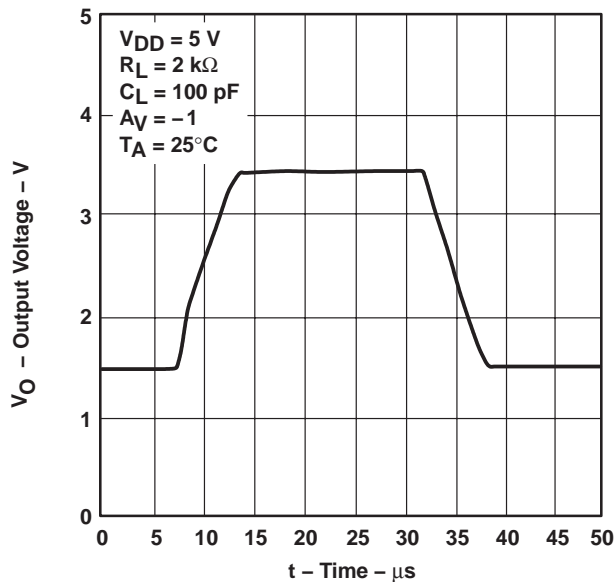
**TYPICAL CHARACTERISTICS**

**INVERTING LARGE-SIGNAL PULSE RESPONSE†**



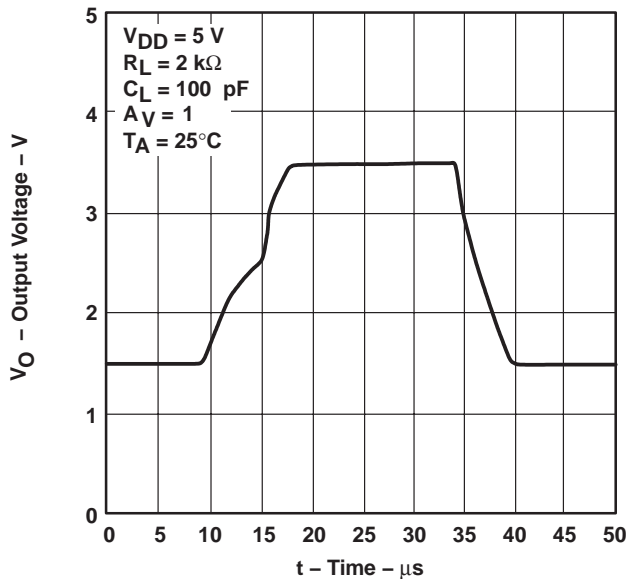
**Figure 35**

**INVERTING LARGE-SIGNAL PULSE RESPONSE†**



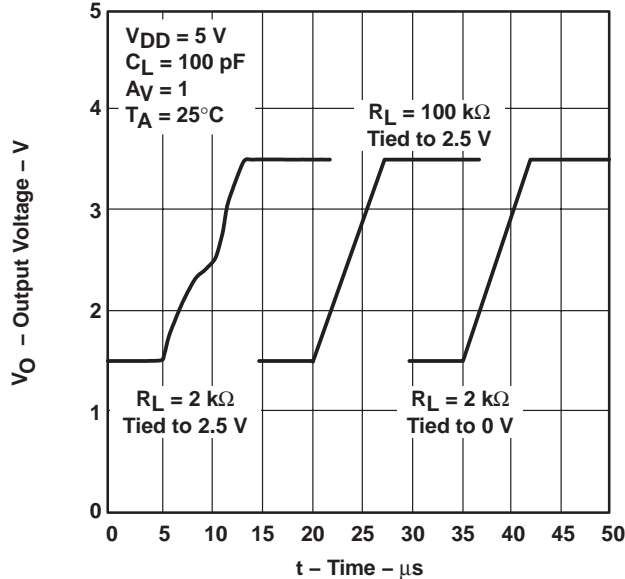
**Figure 36**

**VOLTAGE-FOLLOWER LARGE-SIGNAL PULSE RESPONSE†**



**Figure 37**

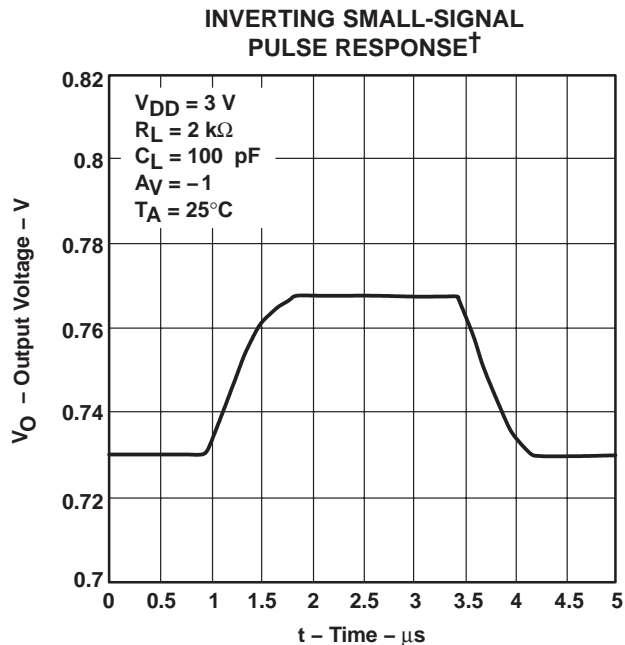
**VOLTAGE-FOLLOWER LARGE-SIGNAL PULSE RESPONSE†**



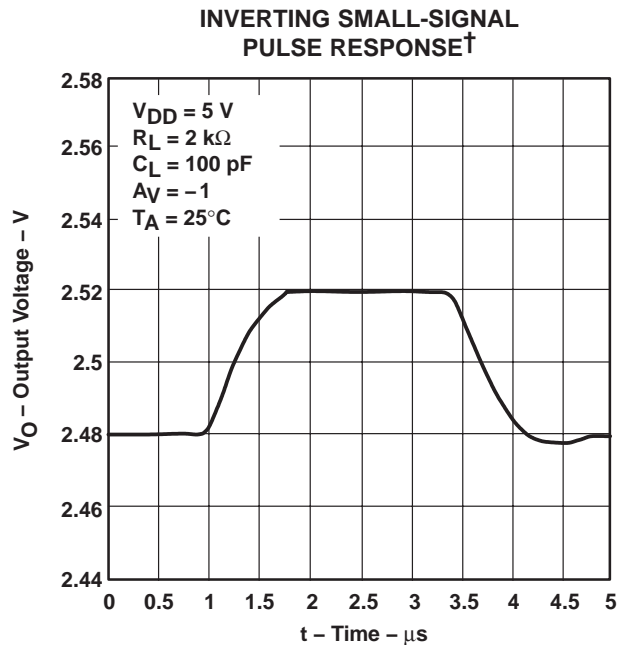
**Figure 38**

† For all curves where  $V_{DD} = 5\text{ V}$ , all loads are referenced to 2.5 V. For all curves where  $V_{DD} = 3\text{ V}$ , all loads are referenced to 1.5 V.

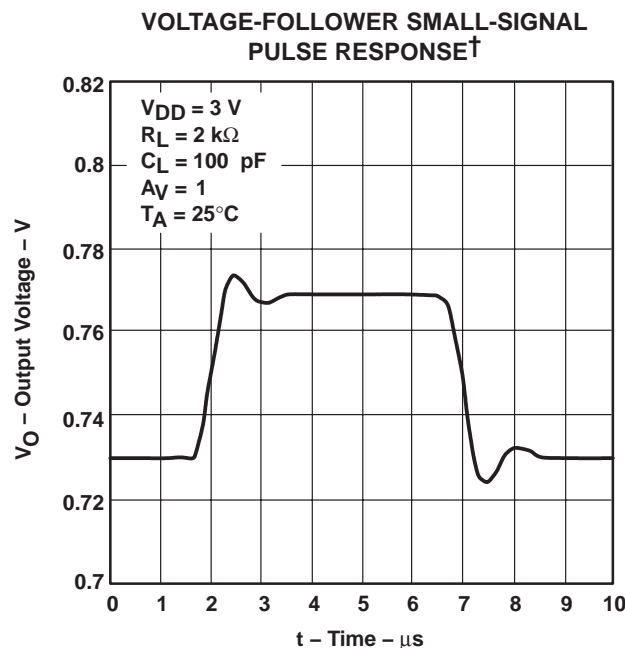
**TYPICAL CHARACTERISTICS**



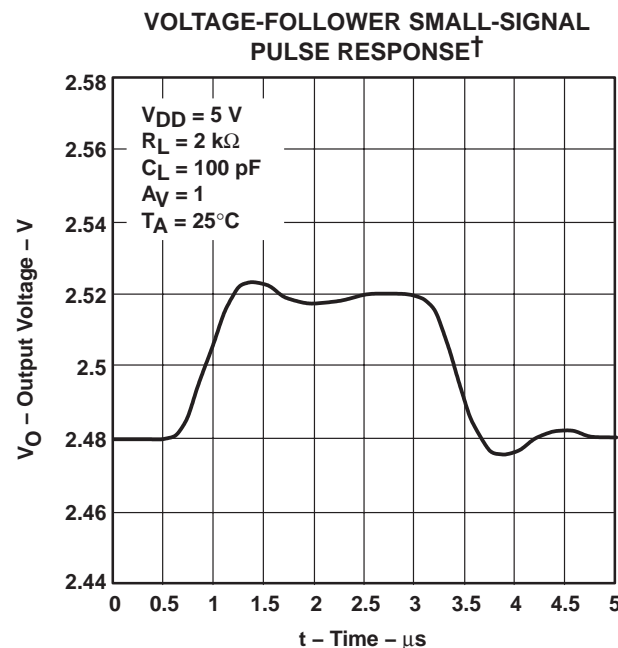
**Figure 39**



**Figure 40**



**Figure 41**

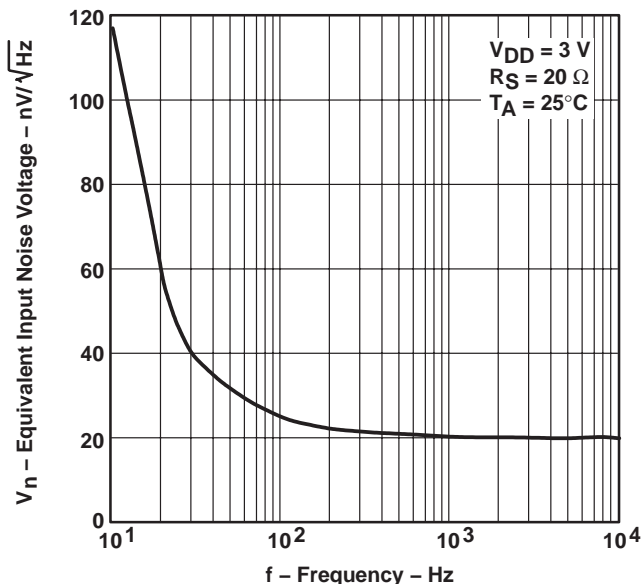


**Figure 42**

† For all curves where  $V_{DD} = 5\text{ V}$ , all loads are referenced to 2.5 V. For all curves where  $V_{DD} = 3\text{ V}$ , all loads are referenced to 1.5 V.

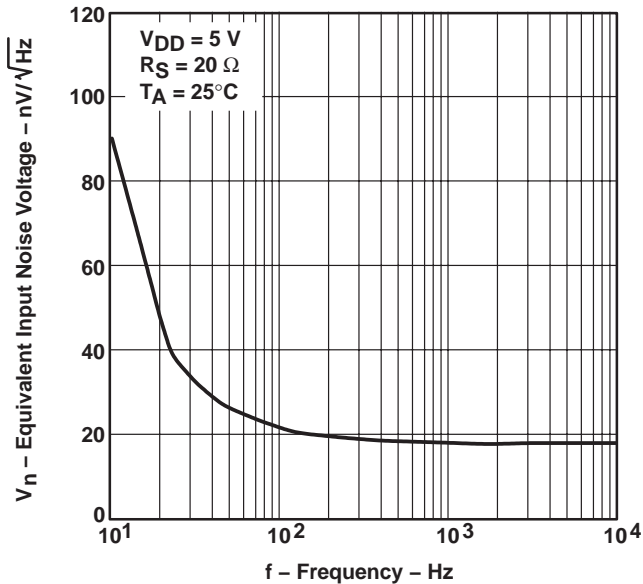
**TYPICAL CHARACTERISTICS**

**EQUIVALENT INPUT NOISE VOLTAGE†  
 VS  
 FREQUENCY**



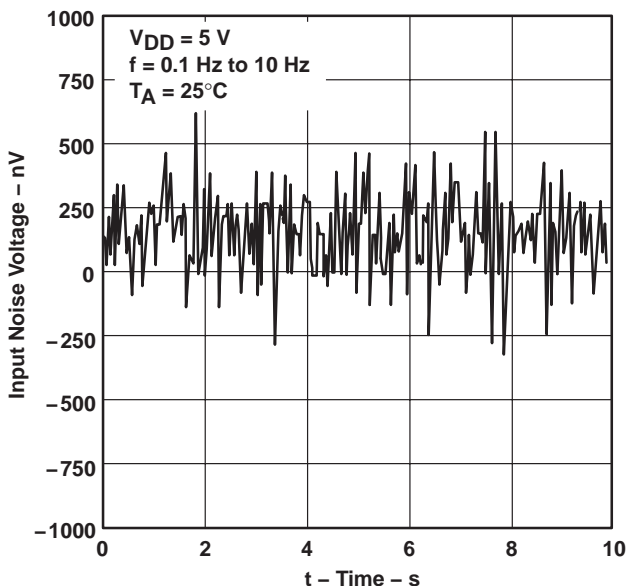
**Figure 43**

**EQUIVALENT INPUT NOISE VOLTAGE†  
 VS  
 FREQUENCY**



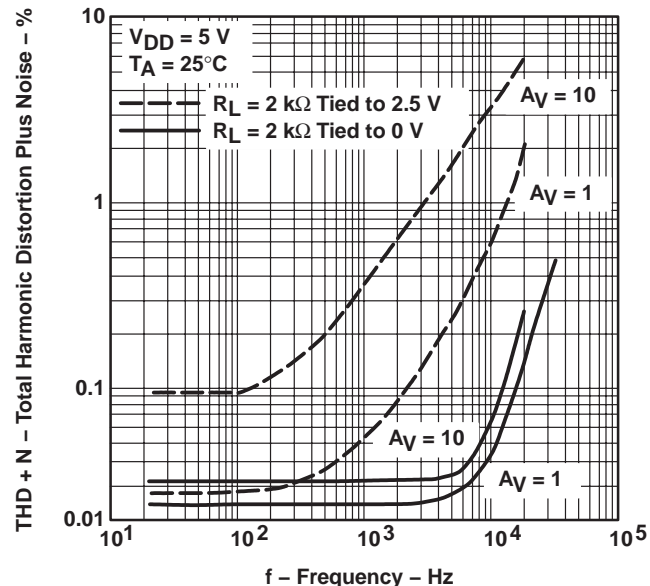
**Figure 44**

**INPUT NOISE VOLTAGE OVER  
 A 10-SECOND PERIOD†**



**Figure 45**

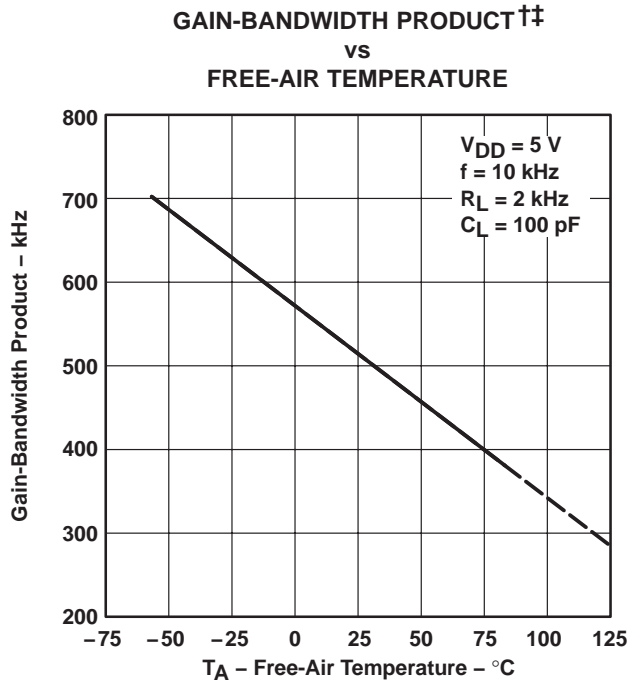
**TOTAL HARMONIC DISTORTION PLUS NOISE†  
 VS  
 FREQUENCY**



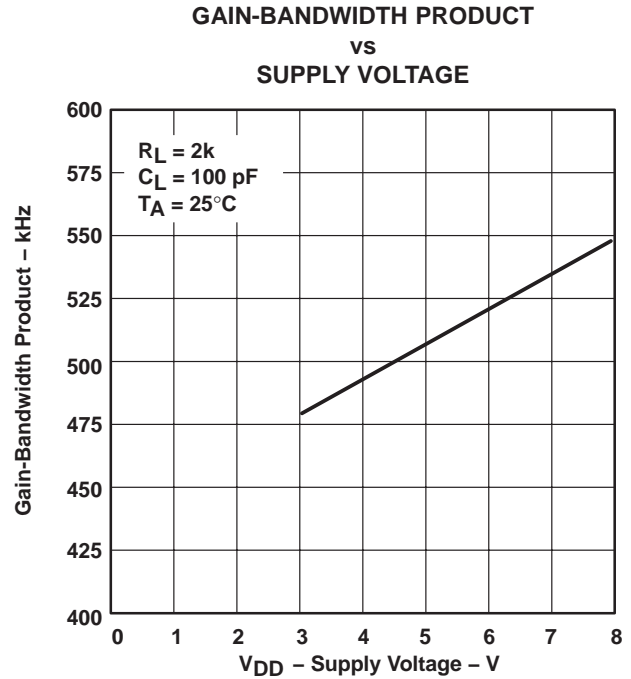
**Figure 46**

† For all curves where  $V_{DD} = 5\text{ V}$ , all loads are referenced to 2.5 V. For all curves where  $V_{DD} = 3\text{ V}$ , all loads are referenced to 1.5 V.

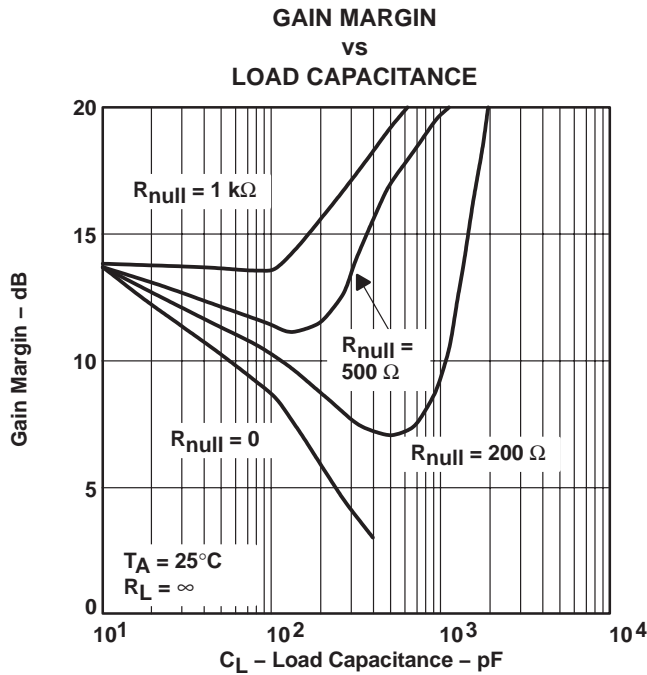
**TYPICAL CHARACTERISTICS**



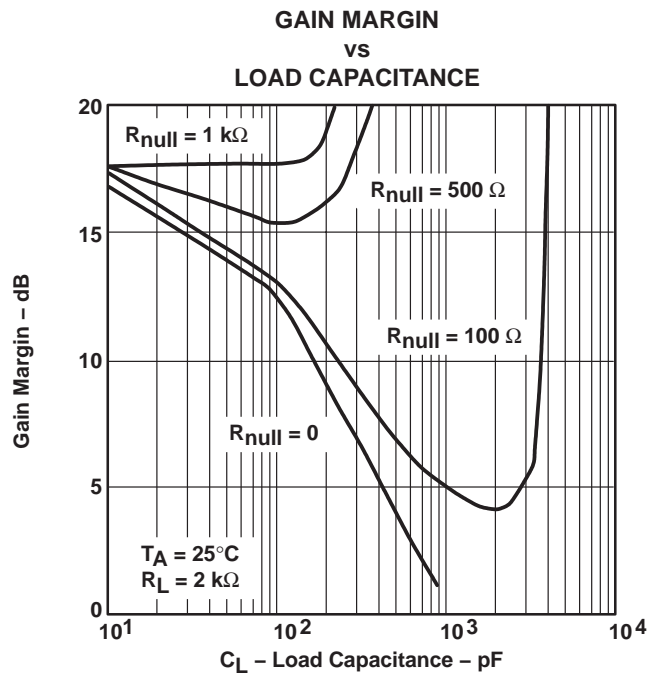
**Figure 47**



**Figure 48**



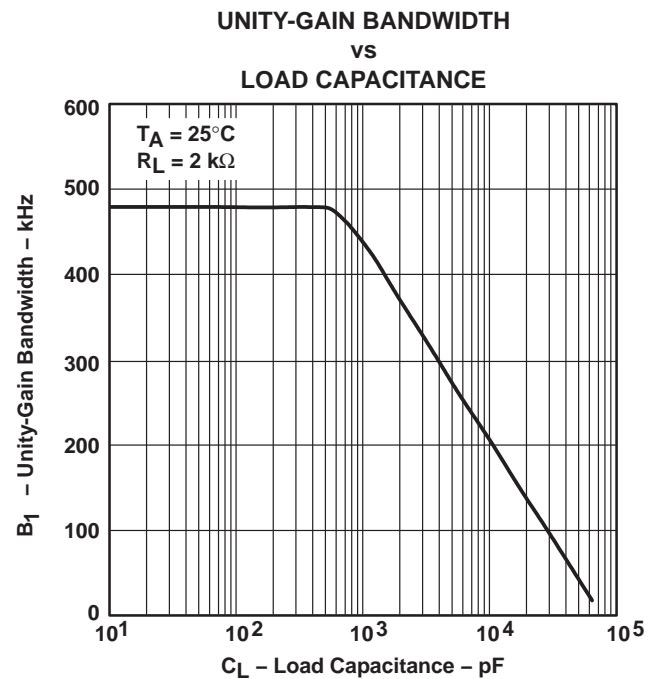
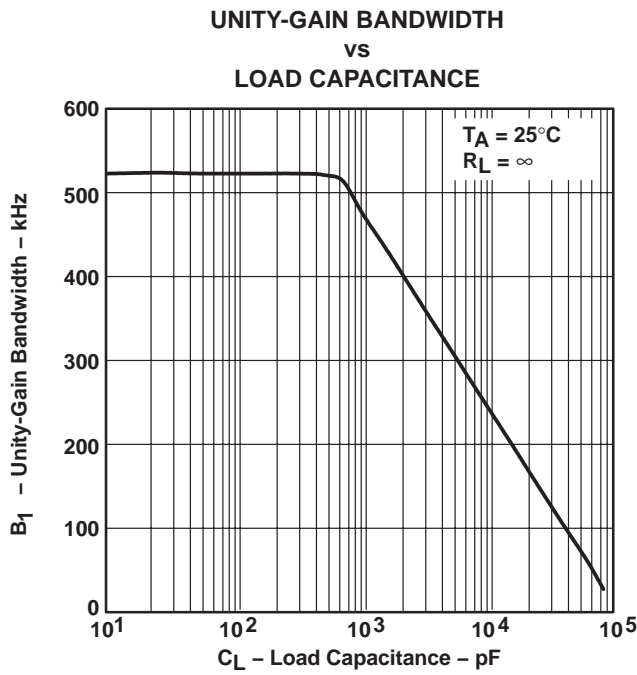
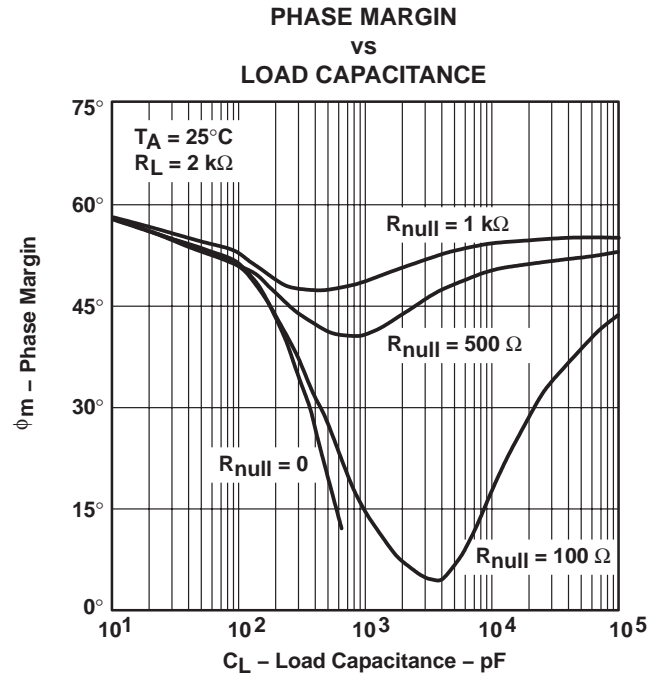
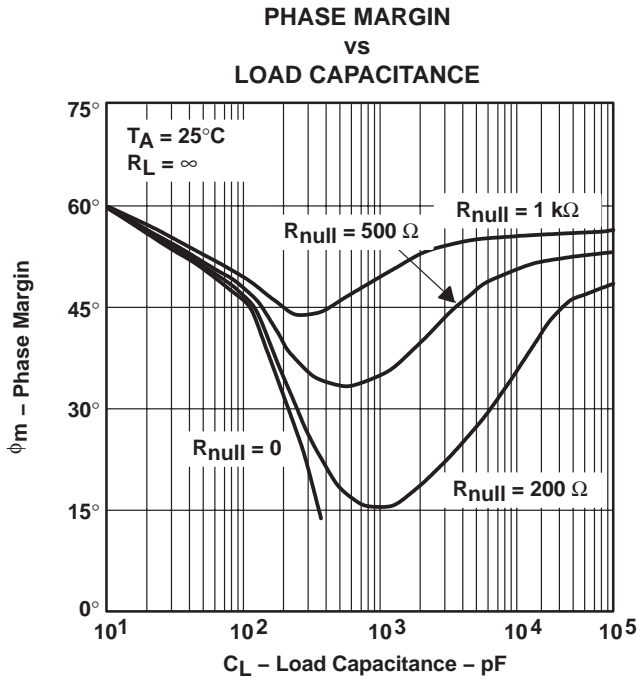
**Figure 49**



**Figure 50**

† Data at high and low temperatures are applicable only within the rated operating free-air temperature ranges of the various devices.  
 †† For all curves where  $V_{DD} = 5\text{ V}$ , all loads are referenced to 2.5 V. For all curves where  $V_{DD} = 3\text{ V}$ , all loads are referenced to 1.5 V.

**TYPICAL CHARACTERISTICS**





## APPLICATION INFORMATION

### driving large capacitive loads

The TLV2721 is designed to drive larger capacitive loads than most CMOS operational amplifiers. Figure 49 through Figure 54 illustrate its ability to drive loads greater than 100 pF while maintaining good gain and phase margins ( $R_{null} = 0$ ).

A small series resistor ( $R_{null}$ ) at the output of the device (Figure 55) improves the gain and phase margins when driving large capacitive loads. Figure 49 through Figure 52 show the effects of adding series resistances of 100  $\Omega$ , 200  $\Omega$ , 500  $\Omega$ , and 1 k $\Omega$ . The addition of this series resistor has two effects: the first effect is that it adds a zero to the transfer function and the second effect is that it reduces the frequency of the pole associated with the output load in the transfer function.

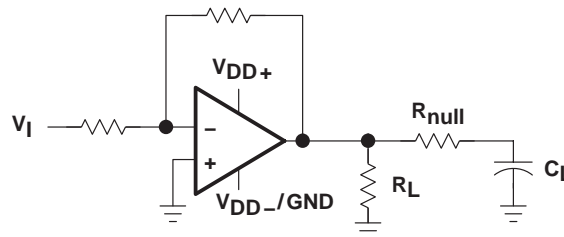
The zero introduced to the transfer function is equal to the series resistance times the load capacitance. To calculate the approximate improvement in phase margin, equation 1 can be used.

$$\Delta\phi_{m1} = \tan^{-1} \left( 2 \times \pi \times \text{UGBW} \times R_{null} \times C_L \right) \quad (1)$$

Where :

- $\Delta\phi_{m1}$  = Improvement in phase margin
- UGBW = Unity-gain bandwidth frequency
- $R_{null}$  = Output series resistance
- $C_L$  = Load capacitance

The unity-gain bandwidth (UGBW) frequency decreases as the capacitive load increases (Figure 53 and Figure 54). To use equation 1, UGBW must be approximated from Figure 54 and Figure 55.



**Figure 55. Series-Resistance Circuit**

The TLV2721 is designed to provide better sinking and sourcing output currents than earlier CMOS rail-to-rail output devices. This device is specified to sink 500  $\mu\text{A}$  and source 1 mA at  $V_{DD} = 5\text{ V}$  at a maximum quiescent  $I_{DD}$  of 200  $\mu\text{A}$ . This provides a greater than 80% power efficiency.

When driving heavy dc loads, such as 2 k $\Omega$ , the positive edge under slewing conditions can experience some distortion. This condition can be seen in Figure 37. This condition is affected by three factors:

- Where the load is referenced. When the load is referenced to either rail, this condition does not occur. The distortion occurs only when the output signal swings through the point where the load is referenced. Figure 38 illustrates two 2-k $\Omega$  load conditions. The first load condition shows the distortion seen for a 2-k $\Omega$  load tied to 2.5 V. The third load condition in Figure 38 shows no distortion for a 2-k $\Omega$  load tied to 0 V.
- Load resistance. As the load resistance increases, the distortion seen on the output decreases. Figure 38 illustrates the difference seen on the output for a 2-k $\Omega$  load and a 100-k $\Omega$  load with both tied to 2.5 V.
- Input signal edge rate. Faster input edge rates for a step input result in more distortion than with slower input edge rates.

# TLV2721, TLV2721Y

## Advanced LinCMOS™ RAIL-TO-RAIL

### VERY LOW-POWER SINGLE OPERATIONAL AMPLIFIERS

SLOS197A – AUGUST 1997 – REVISED MARCH 2001

## APPLICATION INFORMATION

### macromodel information

Macromodel information provided was derived using Microsim *Parts*™, the model generation software used with Microsim *PSpice*™. The Boyle macromodel (see Note 6) and subcircuit in Figure 56 are generated using the TLV2721 typical electrical and operating characteristics at  $T_A = 25^\circ\text{C}$ . Using this information, output simulations of the following key parameters can be generated to a tolerance of 20% (in most cases):

- Maximum positive output voltage swing
- Maximum negative output voltage swing
- Slew rate
- Quiescent power dissipation
- Input bias current
- Open-loop voltage amplification
- Unity-gain frequency
- Common-mode rejection ratio
- Phase margin
- DC output resistance
- AC output resistance
- Short-circuit output current limit

NOTE 6: G. R. Boyle, B. M. Cohn, D. O. Pederson, and J. E. Solomon, "Macromodeling of Integrated Circuit Operational Amplifiers", *IEEE Journal of Solid-State Circuits*, SC-9, 353 (1974).

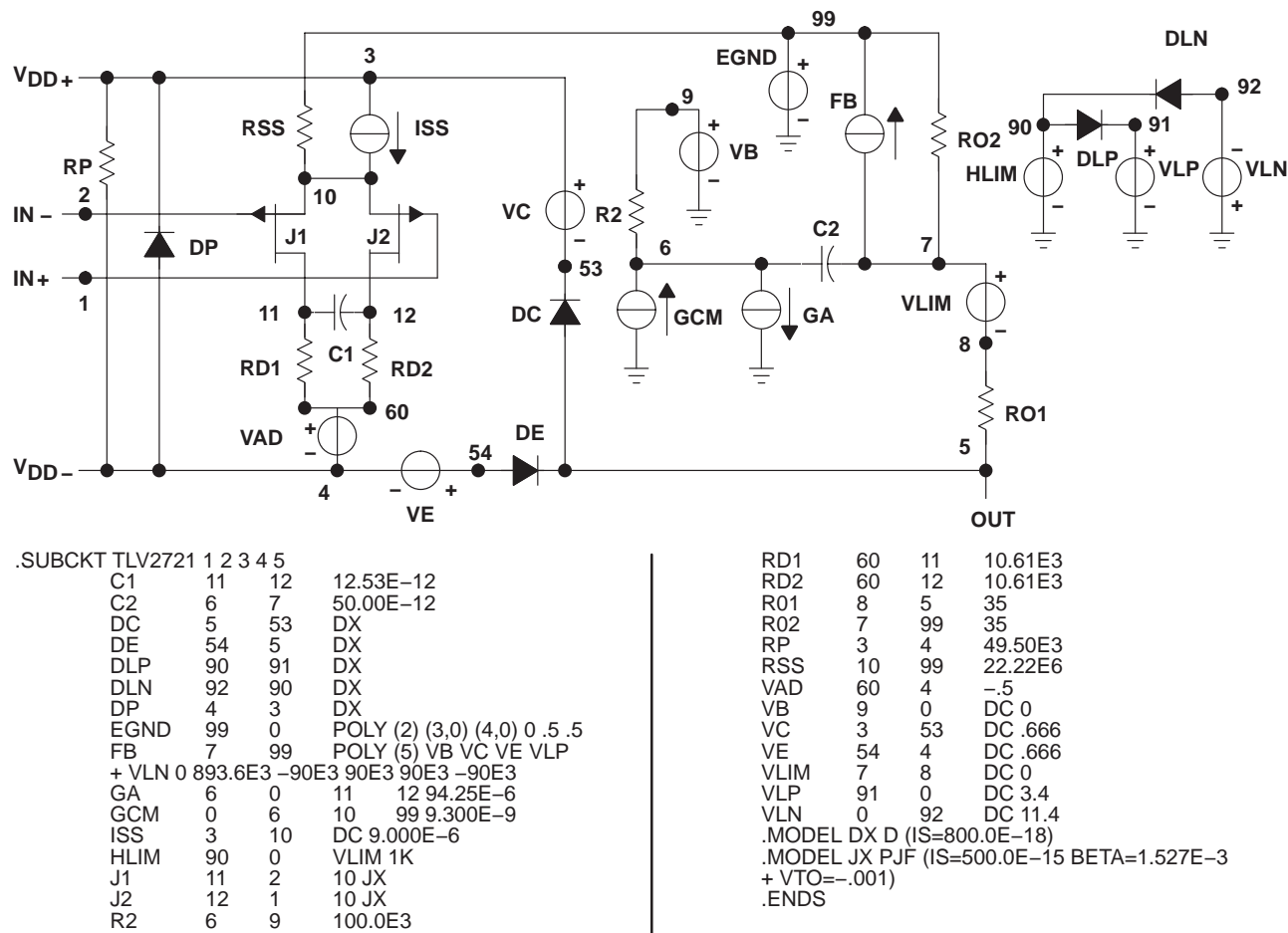




Figure 56. Boyle Macromodel and Subcircuit

*PSpice* and *Parts* are trademark of MicroSim Corporation.

Macromodels, simulation models, or other models provided by TI, directly or indirectly, are not warranted by TI as fully representing all of the specification and operating characteristics of the semiconductor product to which the model relates.



**PACKAGING INFORMATION**

Orderable Device	Status (1)	Package Type	Package Drawing	Pins	Package Qty	Eco Plan (2)	Lead finish/ Ball material (6)	MSL Peak Temp (3)	Op Temp (°C)	Device Marking (4/5)	Samples
TLV2721CDBVR	ACTIVE	SOT-23	DBV	5	3000	Non-RoHS & Green	NIPDAU	Level-1-260C-UNLIM	0 to 70	VAKC	
TLV2721CDBVT	LIFEBUY	SOT-23	DBV	5	250	Non-RoHS & Green	NIPDAU	Level-1-260C-UNLIM		VAKC	
TLV2721IDBVR	ACTIVE	SOT-23	DBV	5	3000	Non-RoHS & Green	NIPDAU	Level-1-260C-UNLIM	-40 to 85	VAKI	
TLV2721IDBVT	LIFEBUY	SOT-23	DBV	5	250	Non-RoHS & Green	NIPDAU	Level-1-260C-UNLIM		VAKI	

(1) The marketing status values are defined as follows:

**ACTIVE:** Product device recommended for new designs.

**LIFEBUY:** TI has announced that the device will be discontinued, and a lifetime-buy period is in effect.

**NRND:** Not recommended for new designs. Device is in production to support existing customers, but TI does not recommend using this part in a new design.

**PREVIEW:** Device has been announced but is not in production. Samples may or may not be available.

**OBSELETE:** TI has discontinued the production of the device.

(2) **RoHS:** TI defines "RoHS" to mean semiconductor products that are compliant with the current EU RoHS requirements for all 10 RoHS substances, including the requirement that RoHS substance do not exceed 0.1% by weight in homogeneous materials. Where designed to be soldered at high temperatures, "RoHS" products are suitable for use in specified lead-free processes. TI may reference these types of products as "Pb-Free".

**RoHS Exempt:** TI defines "RoHS Exempt" to mean products that contain lead but are compliant with EU RoHS pursuant to a specific EU RoHS exemption.

**Green:** TI defines "Green" to mean the content of Chlorine (Cl) and Bromine (Br) based flame retardants meet JS709B low halogen requirements of <=1000ppm threshold. Antimony trioxide based flame retardants must also meet the <=1000ppm threshold requirement.

(3) MSL, Peak Temp. - The Moisture Sensitivity Level rating according to the JEDEC industry standard classifications, and peak solder temperature.

(4) There may be additional marking, which relates to the logo, the lot trace code information, or the environmental category on the device.

(5) Multiple Device Markings will be inside parentheses. Only one Device Marking contained in parentheses and separated by a "~" will appear on a device. If a line is indented then it is a continuation of the previous line and the two combined represent the entire Device Marking for that device.

(6) Lead finish/Ball material - Orderable Devices may have multiple material finish options. Finish options are separated by a vertical ruled line. Lead finish/Ball material values may wrap to two lines if the finish value exceeds the maximum column width.

**Important Information and Disclaimer:**The information provided on this page represents TI's knowledge and belief as of the date that it is provided. TI bases its knowledge and belief on information provided by third parties, and makes no representation or warranty as to the accuracy of such information. Efforts are underway to better integrate information from third parties. TI has taken and

continues to take reasonable steps to provide representative and accurate information but may not have conducted destructive testing or chemical analysis on incoming materials and chemicals. TI and TI suppliers consider certain information to be proprietary, and thus CAS numbers and other limited information may not be available for release.

In no event shall TI's liability arising out of such information exceed the total purchase price of the TI part(s) at issue in this document sold by TI to Customer on an annual basis.

**TAPE AND REEL INFORMATION**



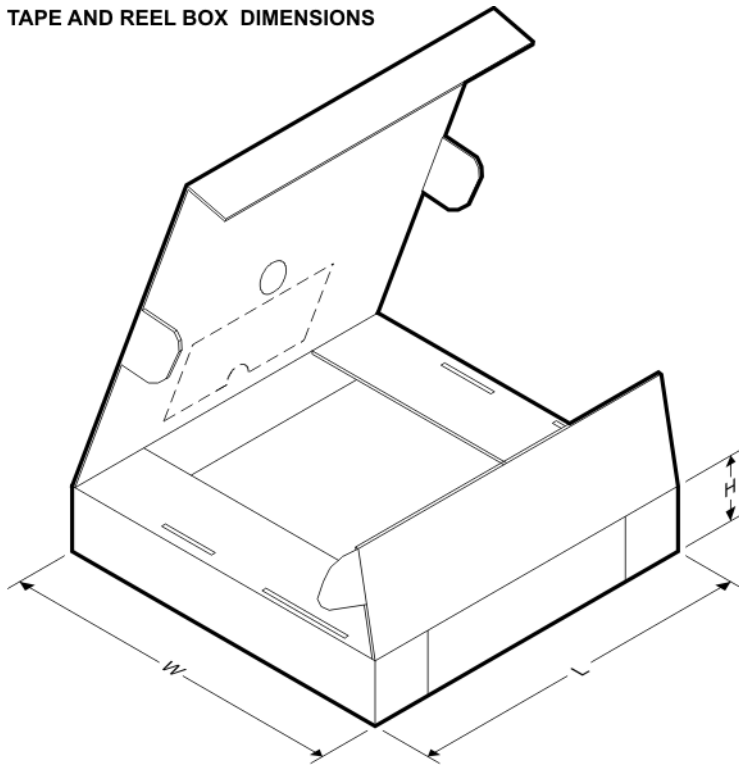
**QUADRANT ASSIGNMENTS FOR PIN 1 ORIENTATION IN TAPE**



\*All dimensions are nominal

Device	Package Type	Package Drawing	Pins	SPQ	Reel Diameter (mm)	Reel Width W1 (mm)	A0 (mm)	B0 (mm)	K0 (mm)	P1 (mm)	W (mm)	Pin1 Quadrant
TLV2721CDBVR	SOT-23	DBV	5	3000	180.0	9.0	3.15	3.2	1.4	4.0	8.0	Q3
TLV2721CDBVT	SOT-23	DBV	5	250	180.0	9.0	3.15	3.2	1.4	4.0	8.0	Q3
TLV2721IDBVR	SOT-23	DBV	5	3000	180.0	9.0	3.15	3.2	1.4	4.0	8.0	Q3
TLV2721IDBVT	SOT-23	DBV	5	250	180.0	9.0	3.15	3.2	1.4	4.0	8.0	Q3

**TAPE AND REEL BOX DIMENSIONS**



\*All dimensions are nominal

Device	Package Type	Package Drawing	Pins	SPQ	Length (mm)	Width (mm)	Height (mm)
TLV2721CDBVR	SOT-23	DBV	5	3000	182.0	182.0	20.0
TLV2721CDBVT	SOT-23	DBV	5	250	182.0	182.0	20.0
TLV2721IDBVR	SOT-23	DBV	5	3000	182.0	182.0	20.0
TLV2721IDBVT	SOT-23	DBV	5	250	182.0	182.0	20.0

## IMPORTANT NOTICE AND DISCLAIMER

TI PROVIDES TECHNICAL AND RELIABILITY DATA (INCLUDING DATA SHEETS), DESIGN RESOURCES (INCLUDING REFERENCE DESIGNS), APPLICATION OR OTHER DESIGN ADVICE, WEB TOOLS, SAFETY INFORMATION, AND OTHER RESOURCES "AS IS" AND WITH ALL FAULTS, AND DISCLAIMS ALL WARRANTIES, EXPRESS AND IMPLIED, INCLUDING WITHOUT LIMITATION ANY IMPLIED WARRANTIES OF MERCHANTABILITY, FITNESS FOR A PARTICULAR PURPOSE OR NON-INFRINGEMENT OF THIRD PARTY INTELLECTUAL PROPERTY RIGHTS.

These resources are intended for skilled developers designing with TI products. You are solely responsible for (1) selecting the appropriate TI products for your application, (2) designing, validating and testing your application, and (3) ensuring your application meets applicable standards, and any other safety, security, regulatory or other requirements.

These resources are subject to change without notice. TI grants you permission to use these resources only for development of an application that uses the TI products described in the resource. Other reproduction and display of these resources is prohibited. No license is granted to any other TI intellectual property right or to any third party intellectual property right. TI disclaims responsibility for, and you will fully indemnify TI and its representatives against, any claims, damages, costs, losses, and liabilities arising out of your use of these resources.

TI's products are provided subject to [TI's Terms of Sale](#) or other applicable terms available either on [ti.com](https://www.ti.com) or provided in conjunction with such TI products. TI's provision of these resources does not expand or otherwise alter TI's applicable warranties or warranty disclaimers for TI products.

TI objects to and rejects any additional or different terms you may have proposed.

Mailing Address: Texas Instruments, Post Office Box 655303, Dallas, Texas 75265  
Copyright © 2023, Texas Instruments Incorporated