

TLV34xx Low-Voltage Rail-to-Rail Output CMOS Operational Amplifiers With Shutdown

1 Features

- 1.8-V and 5-V Performance
- Low Offset (A Grade)
 - 1.25 mV Maximum (25°C)
 - 1.7 mV Maximum (–40°C to 125°C)
- Rail-to-Rail Output Swing
- Wide Common-Mode Input Voltage Range: –0.2 V to (V_+ – 0.5 V)
- Input Bias Current: 1 pA (Typical)
- Input Offset Voltage: 0.3 mV (Typical)
- Low Supply Current: 70 μ A/Channel
- Low Shutdown Current: 10 pA (Typical) Per Channel
- Gain Bandwidth: 2.3 MHz (Typical)
- Slew Rate: 0.9 V/ μ s (Typical)
- Turnon Time From Shutdown: 5 μ s (Typical)
- Input Referred Voltage Noise (at 10 kHz): 20 nV/ $\sqrt{\text{Hz}}$
- ESD Protection Exceeds JESD 22
 - 2000-V Human-Body Model (HBM)
 - 750-V Charged-device model (CDM)

2 Applications

- Cellular Phones
- Consumer Electronics (Laptops)
- Audio Preamplifier for Voice
- Portable and Battery-Powered Electronic Equipment
- Supply Current Monitoring
- Battery Monitoring
- Buffers
- Filters

3 Description

The TLV34xx devices are single and dual CMOS operational amplifiers, respectively, with low-voltage, low-power, and rail-to-rail output swing capabilities. The PMOS input stage offers an ultra-low input bias current of 1 pA (typical) and an offset voltage of 0.3 mV (typical). For applications requiring excellent dc precision, the A grade (TLV34xA) has a low offset voltage of 1.25 mV (maximum) at 25°C.

These single-supply amplifiers are designed specifically for ultra-low-voltage (1.5 V to 5 V) operation, with a common-mode input voltage range that typically extends from –0.2 V to 0.5 V from the positive supply rail.

The TLV341 (single) and TLV342 (dual) in the RUG package also offer a shutdown (SHDN) pin that can be used to disable the device. In shutdown mode, the supply current is reduced to 45 pA (typical). Offered in both the SOT-23 and smaller SC70 packages, the TLV341 is suitable for the most space-constrained applications. The dual TLV342 is offered in the standard SOIC, VSSOP, and X2QFN packages.

An extended industrial temperature range from –40°C to 125°C makes the TLV34xx suitable in a wide variety of commercial and industrial applications.

Device Information⁽¹⁾

PART NUMBER	PACKAGE	BODY SIZE (NOM)
TLV341	SOT-23 (6)	2.90 mm x 1.60 mm
	SC70 (6)	2.00 mm x 1.25 mm
	SOT (6)	1.60 mm x 1.20 mm
TLV342	SOIC (8)	4.90 mm x 3.91 mm
	VSSOP (8)	3.00 mm x 3.00 mm
	X2QFN (10)	1.50 mm x 2.00 mm
TLV342S	X2QFN (10)	1.50 mm x 2.00 mm

(1) For all available packages, see the orderable addendum at the end of the data sheet.

Sample and Hold Circuit Using Two TLV341

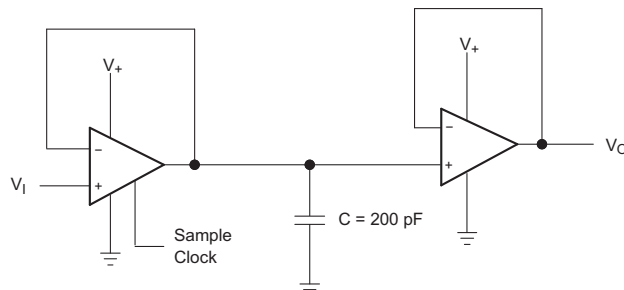

Copyright © 2016, Texas Instruments Incorporated



Table of Contents

1 Features	1	7.1 Overview	15
2 Applications	1	7.2 Functional Block Diagram	15
3 Description	1	7.3 Feature Description	15
4 Revision History	2	7.4 Device Functional Modes	15
5 Pin Configuration and Functions	3	8 Application and Implementation	16
6 Specifications	4	8.1 Application Information	16
6.1 Absolute Maximum Ratings	4	8.2 Typical Application	16
6.2 ESD Ratings	4	9 Power Supply Recommendations	17
6.3 Recommended Operating Conditions	5	10 Layout	18
6.4 Thermal Information: TLV341	5	10.1 Layout Guidelines	18
6.5 Thermal Information: TLV342	5	10.2 Layout Example	18
6.6 Thermal Information: TLV342S	5	11 Device and Documentation Support	19
6.7 Electrical Characteristics: $V_+ = 1.8\text{ V}$	6	11.1 Related Links	19
6.8 Electrical Characteristics: $V_+ = 5\text{ V}$	7	11.2 Community Resource	19
6.9 Shutdown Characteristics: $V_+ = 1.8\text{ V}$	8	11.3 Trademarks	19
6.10 Shutdown Characteristics: $V_+ = 5\text{ V}$	8	11.4 Electrostatic Discharge Caution	19
6.11 Typical Characteristics	9	11.5 Glossary	19
7 Detailed Description	15	12 Mechanical, Packaging, and Orderable Information	19

4 Revision History

NOTE: Page numbers for previous revisions may differ from page numbers in the current version.

Changes from Revision C (November 2007) to Revision D	Page
<ul style="list-style-type: none"> Added <i>ESD Ratings</i> table, <i>Feature Description</i> section, <i>Device Functional Modes</i>, <i>Application and Implementation</i> section, <i>Power Supply Recommendations</i> section, <i>Layout</i> section, <i>Device and Documentation Support</i> section, and <i>Mechanical, Packaging, and Orderable Information</i> section 	1
<ul style="list-style-type: none"> Removed DPK package and TLV344 part from the <i>Pin Configuration and Functions</i> table 	3

5 Pin Configuration and Functions

TLV341 DBV or DCK Package
6-Pin SOT-23 or SC70
Top View

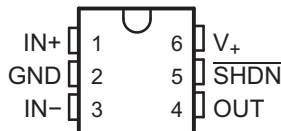

TLV341 DRL Package
6-Pin SOT
Top View

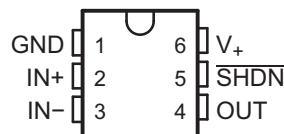

Pin Functions: TLV341

NAME	PIN		I/O	DESCRIPTION
	SOT-23, SC70	SOT		
1IN+	1	2	I	Noninverting input on channel 1
1IN-	3	3	I	Inverting input on channel 1
1OUT	4	4	O	Output on channel 1
GND	2	1	—	Ground
SHDN	5	5	I	Shutdown active low
V+	6	6	—	Positive power supply

TLV342 D or DGK Package
10-Pin SOIC or VSSOP
Top View

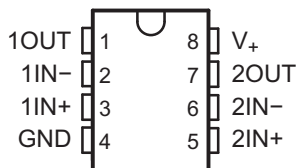

TLV342 RUG Package
10-Pin X2QFN
Top View

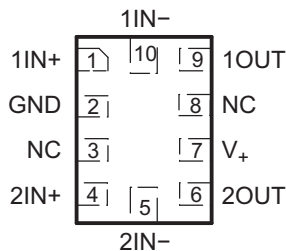

Pin Functions: TLV342

NAME	PIN		I/O	DESCRIPTION
	SOIC, VSSOP	X2QFN		
1IN+	3	1	I	Noninverting input on channel 1
1IN-	2	10	I	Inverting input on channel 1
1OUT	1	9	O	Output on channel 1
2IN+	5	4	I	Noninverting input on channel 2
2IN-	6	5	I	Inverting input on channel 2
2OUT	7	6	O	Output on channel 2
GND	4	2	—	Ground
NC ⁽¹⁾	—	3, 8	—	Not connected
V+	8	7	—	Positive power supply

(1) NC – No internal connection

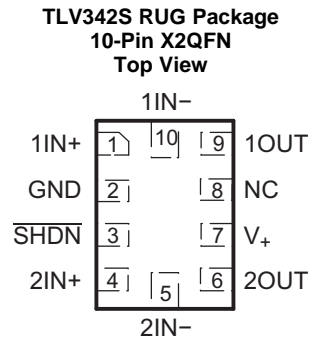
Pin Functions: TLV342S

PIN		I/O	DESCRIPTION
NAME	NO.		
1IN+	1	I	Noninverting input on channel 1
1IN–	10	I	Inverting input on channel 1
1OUT	9	O	Output on channel 1
2IN+	4	I	Noninverting input on channel 2
2IN–	5	I	Inverting input on channel 2
2OUT	6	O	Output on channel 2
GND	2	—	Ground
NC ⁽¹⁾	8	—	Not connected
$\overline{\text{SHDN}}$	3	I	Shutdown active low
V ₊	7	—	Positive power supply

(1) NC – No internal connection

6 Specifications

6.1 Absolute Maximum Ratings

over operating free-air temperature range (unless otherwise noted)⁽¹⁾

		MIN	MAX	UNIT
V ₊	Supply voltage ⁽²⁾	–0.3	5.5	V
V _{ID}	Differential input voltage ⁽³⁾		±5.5	V
V _I	Input voltage (either input or $\overline{\text{shutdown}}$)	–0.3	5.5	V
V _O	Output voltage	–0.3	V _{CC} + 0.3	V
T _J	Operating virtual-junction temperature		150	°C
T _{stg}	Storage temperature	–65	150	°C

- (1) Stresses beyond those listed under *Absolute Maximum Ratings* may cause permanent damage to the device. These are stress ratings only, and functional operation of the device at these or any other conditions beyond those indicated under *Recommended Operating Conditions* is not implied. Exposure to absolute-maximum-rated conditions for extended periods may affect device reliability.
- (2) All voltage values (except differential voltages) are with respect to the network GND.
- (3) Differential voltages are at IN+ with respect to IN–.

6.2 ESD Ratings

		VALUE	UNIT
V _(ESD)	Electrostatic discharge	Human-body model (HBM), per ANSI/ESDA/JEDEC JS-001 ⁽¹⁾	±2000
		Charged-device model (CDM), per JEDEC specification JESD22-C101 ⁽²⁾	±750

- (1) JEDEC document JEP155 states that 500-V HBM allows safe manufacturing with a standard ESD control process.
- (2) JEDEC document JEP157 states that 250-V CDM allows safe manufacturing with a standard ESD control process.

6.3 Recommended Operating Conditions

		MIN	MAX	UNIT
V_+	Supply voltage (single-supply operation)	1.5	5.5	V
T_A	Operating free-air temperature	-40	125	°C

6.4 Thermal Information: TLV341

THERMAL METRIC ⁽¹⁾		TLV341			UNIT
		DBV (SOT-23)	DCK (SC70)	DRL (SOT)	
		6 PINS	6 PINS	6 PINS	
$R_{\theta JA}$	Junction-to-ambient thermal resistance	193.4	196.8	221.1	°C/W
$R_{\theta JC(top)}$	Junction-to-case (top) thermal resistance	145.6	82.4	109.1	°C/W
$R_{\theta JB}$	Junction-to-board thermal resistance	44.1	95.2	111.4	°C/W
Ψ_{JT}	Junction-to-top characterization parameter	34.1	1.8	6.2	°C/W
Ψ_{JB}	Junction-to-board characterization parameter	43.4	93.2	109.8	°C/W

(1) For more information about traditional and new thermal metrics, see the *Semiconductor and IC Package Thermal Metrics* application report, [SPRA953](#).

6.5 Thermal Information: TLV342

THERMAL METRIC ⁽¹⁾		TLV342			UNIT
		D (SOIC)	DGK (MSOP)	RUG (X2QFN)	
		8 PINS	8 PINS	10 PINS	
$R_{\theta JA}$	Junction-to-ambient thermal resistance	123.6	192.3	167	°C/W
$R_{\theta JC(top)}$	Junction-to-case (top) thermal resistance	69.8	78.2	56.5	°C/W
$R_{\theta JB}$	Junction-to-board thermal resistance	63.9	112.6	94.3	°C/W
Ψ_{JT}	Junction-to-top characterization parameter	24.4	15.2	4.1	°C/W
Ψ_{JB}	Junction-to-board characterization parameter	63.4	111.2	94	°C/W

(1) For more information about traditional and new thermal metrics, see the *Semiconductor and IC Package Thermal Metrics* application report, [SPRA953](#).

6.6 Thermal Information: TLV342S

THERMAL METRIC ⁽¹⁾		TLV342S	UNIT
		RUG (X2QFN)	
		10 PINS	
$R_{\theta JA}$	Junction-to-ambient thermal resistance	158.3	°C/W
$R_{\theta JC(top)}$	Junction-to-case (top) thermal resistance	52.6	°C/W
$R_{\theta JB}$	Junction-to-board thermal resistance	87.9	°C/W
Ψ_{JT}	Junction-to-top characterization parameter	1	°C/W
Ψ_{JB}	Junction-to-board characterization parameter	87	°C/W

(1) For more information about traditional and new thermal metrics, see the *Semiconductor and IC Package Thermal Metrics* application report, [SPRA953](#).

6.7 Electrical Characteristics: $V_+ = 1.8\text{ V}$

$V_+ = 1.8\text{ V}$, $\text{GND} = 0\text{ V}$, $V_{\text{IC}} = V_{\text{O}} = V_+/2$, $R_{\text{L}} > 1\text{ M}\Omega$ (unless otherwise noted). See [Shutdown Characteristics: \$V_+ = 1.8\text{ V}\$](#) .

PARAMETER		TEST CONDITIONS		T_{A}	MIN	TYP ⁽¹⁾	MAX	UNIT	
V_{IO}	Input offset voltage	Standard grade		25°C		0.3	4	mV	
				Full range			4.5		
		A grade		25°C		0.3	1.25		
				0°C to 125°C		0.3	1.5		
				-40°C to 125°C		0.3	1.7		
α_{VIO}	Average temperature coefficient of input offset voltage			Full range		1.9		$\mu\text{V}/^\circ\text{C}$	
I_{IB}	Input bias current			25°C		1	100	pA	
				-40°C to 85°C			375		
				-40°C to 125°C			3000		
I_{IO}	Input offset current			25°C		6.6		fA	
CMRR	Common-mode rejection ratio	$0 \leq V_{\text{ICR}} \leq 1.2\text{ V}$		25°C	60	85		dB	
				Full range	50				
k_{SVR}	Supply-voltage rejection ratio	$1.8\text{ V} \leq V_+ \leq 5\text{ V}$		25°C	75	95		dB	
				Full range	65				
V_{ICR}	Common-mode input voltage range	$\text{CMRR} \geq 60\text{ dB}$		25°C	0		1.2	V	
A_{V}	Large-signal voltage gain ⁽²⁾	$R_{\text{L}} = 10\text{ k}\Omega$ to 1.35 V		25°C	70	110		dB	
				Full range	60				
		$R_{\text{L}} = 2\text{ k}\Omega$ to 1.35 V		25°C	65	100			
				Full range	55				
V_{O}	Output swing (delta from supply rails)	$R_{\text{L}} = 2\text{ k}\Omega$ to 1.35 V	Low level	25°C		22	50	mV	
				Full range			75		
			High level	25°C		25	50		
				Full range			75		
		$R_{\text{L}} = 10\text{ k}\Omega$ to 1.35 V	Low level	25°C		14	20		
				Full range			25		
			High level	25°C		7	20		
				Full range			25		
I_{CC}	Supply current (per channel)			25°C		70	150	μA	
				Full range			200		
I_{OS}	Output short-circuit current			25°C	Sourcing		6	12	mA
					Sinking		10	20	
SR	Slew rate	$R_{\text{L}} = 10\text{ k}\Omega$ ⁽³⁾		25°C		0.9		V/ μs	
GBW	Unity-gain bandwidth	$R_{\text{L}} = 10\text{ k}\Omega$, $C_{\text{L}} = 200\text{ pF}$		25°C		2.2		MHz	
ϕ_{m}	Phase margin	$R_{\text{L}} = 100\text{ k}\Omega$, $C_{\text{L}} = 200\text{ pF}$		25°C		55		°	
G_{m}	Gain margin	$R_{\text{L}} = 100\text{ k}\Omega$, $C_{\text{L}} = 200\text{ pF}$		25°C		15		dB	
V_{n}	Equivalent input noise voltage	$f = 1\text{ kHz}$		25°C		33		$\text{nV}/\sqrt{\text{Hz}}$	
I_{n}	Equivalent input noise current	$f = 1\text{ kHz}$		25°C		0.001		$\text{pA}/\sqrt{\text{Hz}}$	
THD	Total harmonic distortion	$f = 1\text{ kHz}$, $A_{\text{V}} = 1$, $R_{\text{L}} = 600\ \Omega$, $V_{\text{I}} = 1\text{ V}_{\text{PP}}$		25°C		0.015%			

(1) Typical values represent the most likely parametric norm.

(2) $\text{GND} + 0.2\text{ V} \leq V_{\text{O}} \leq V_+ - 0.2\text{ V}$

(3) Connected as voltage follower with $2\text{-}V_{\text{PP}}$ step input. Number specified is the slower of the positive and negative slew rates.

6.8 Electrical Characteristics: $V_+ = 5\text{ V}$

$V_+ = 5\text{ V}$, $\text{GND} = 0\text{ V}$, $V_{IC} = V_O = V_+/2$, $R_L > 1\text{ M}\Omega$ (unless otherwise noted). See [Shutdown Characteristics: \$V_+ = 5\text{ V}\$](#) .

PARAMETER		TEST CONDITIONS	T_A	MIN	TYP ⁽¹⁾	MAX	UNIT
V_{IO}	Input offset voltage	Standard grade	25°C		0.3	4	mV
			Full range			4.5	
		A grade	25°C		0.3	1.25	
			0°C to 125°C		0.3	1.5	
			–40°C to 125°C		0.3	1.7	
α_{VIO}	Average temperature coefficient of input offset voltage	Full range		1.9		$\mu\text{V}/^\circ\text{C}$	
I_{IB}	Input bias current		25°C		1	200	pA
			–40°C to 85°C			375	
			–40°C to 125°C			3000	
I_{IO}	Input offset current		25°C		6.6	fA	
CMRR	Common-mode rejection ratio	$0 \leq V_{ICR} \leq 4.4\text{ V}$	25°C	75	90	dB	
			Full range	70			
k_{SVR}	Supply-voltage rejection ratio	$1.8\text{ V} \leq V_+ \leq 5\text{ V}$	25°C	75	95	dB	
			Full range	65			
V_{ICR}	Common-mode input voltage range	CMRR $\geq 70\text{ dB}$	25°C	0		4.4	V
A_V	Large-signal voltage gain ⁽²⁾	$R_L = 10\text{ k}\Omega$ to 2.5 V	25°C	80	110	dB	
			Full range	70			
		$R_L = 2\text{ k}\Omega$ to 2.5 V	25°C	75	105		
			Full range	60			
V_O	Output swing (delta from supply rails)	$R_L = 2\text{ k}\Omega$ to 2.5 V	Low level	25°C	40	60	mV
				Full range		85	
			High level	25°C	25	60	
				Full range		85	
		$R_L = 10\text{ k}\Omega$ to 2.5 V	Low level	25°C	18	30	
				Full range		40	
			High level	25°C	7	15	
				Full range		20	
I_{CC}	Supply current (per channel)		25°C	75	150	μA	
			Full range		200		
I_{OS}	Output short-circuit current	Sourcing	25°C	60	113	mA	
		Sinking		80	115		
SR	Slew rate	$R_L = 10\text{ k}\Omega$ ⁽³⁾	25°C		1	V/ μs	
GBW	Unity-gain bandwidth	$R_L = 10\text{ k}\Omega$, $C_L = 200\text{ pF}$	25°C		2.3	MHz	
ϕ_m	Phase margin	$R_L = 100\text{ k}\Omega$, $C_L = 200\text{ pF}$	25°C		55	°	
G_m	Gain margin	$R_L = 100\text{ k}\Omega$, $C_L = 200\text{ pF}$	25°C		15	dB	
V_n	Equivalent input noise voltage	$f = 1\text{ kHz}$	25°C		33	$\text{nV}/\sqrt{\text{Hz}}$	
I_n	Equivalent input noise current	$f = 1\text{ kHz}$	25°C		0.001	$\text{pA}/\sqrt{\text{Hz}}$	
THD	Total harmonic distortion	$f = 1\text{ kHz}$, $A_V = 1$, $R_L = 600\ \Omega$, $V_I = 1\text{ V}_{PP}$	25°C		0.012%		

(1) Typical values represent the most likely parametric norm.

(2) $\text{GND} + 0.2\text{ V} \leq V_O \leq V_+ - 0.2\text{ V}$

(3) Connected as voltage follower with 2- V_{PP} step input. Number specified is the slower of the positive and negative slew rates.

6.9 Shutdown Characteristics: $V_+ = 1.8\text{ V}$

 $V_+ = 1.8\text{ V}$, $GND = 0\text{ V}$, $V_{IC} = V_O = V_+/2$, $R_L > 1\text{ M}\Omega$ (unless otherwise noted)

PARAMETER		TEST CONDITIONS	T_A	MIN	TYP	MAX	UNIT
$I_{CC(SHDN)}$	Supply current in shutdown mode	$V_{SD} = 0\text{ V}$	25°C		0.01	1	μA
			Full range			1.5	
$t_{(on)}$	Amplifier turnon time		25°C		5		μs
V_{SD}	Recommended shutdown pin voltage range	On mode	25°C	1.5		1.8	V
		Shutdown mode		0		0.5	

6.10 Shutdown Characteristics: $V_+ = 5\text{ V}$

 $V_+ = 5\text{ V}$, $GND = 0\text{ V}$, $V_{IC} = V_O = V_+/2$, $R_L > 1\text{ M}\Omega$ (unless otherwise noted)

PARAMETER		TEST CONDITIONS	T_A	MIN	TYP	MAX	UNIT
$I_{CC(SHDN)}$	Supply current in shutdown mode	$V_{SD} = 0\text{ V}$	25°C		0.01	1	μA
			Full range			1.5	
$t_{(on)}$	Amplifier turnon time		25°C		5		μs
V_{SD}	Recommended shutdown pin voltage range	On mode	25°C	4.5		5	V
		Shutdown mode		0		0.8	

6.11 Typical Characteristics

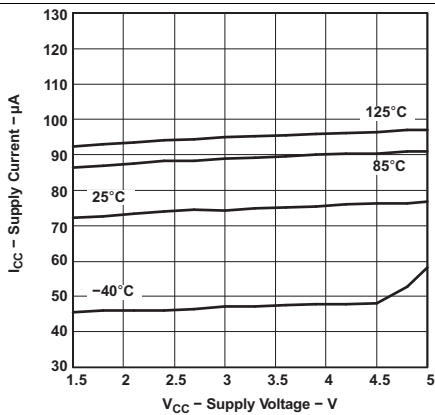

Figure 1. Supply Current vs Supply Voltage

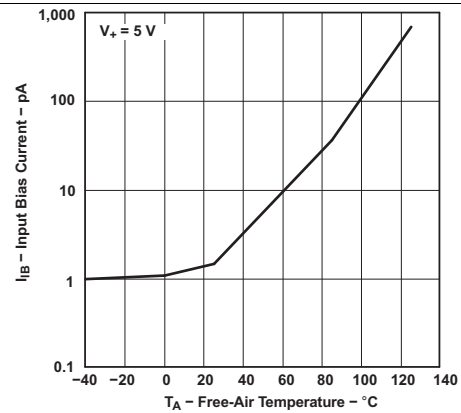

Figure 2. Input Bias Current vs Temperature

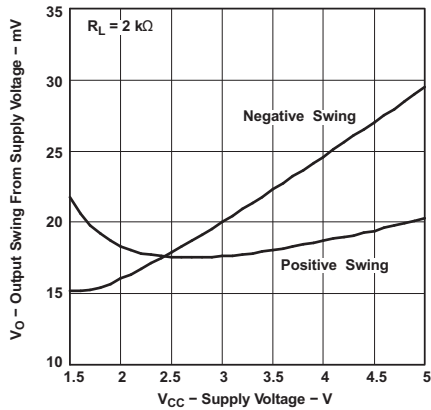

Figure 3. Output Voltage Swing vs Supply Voltage

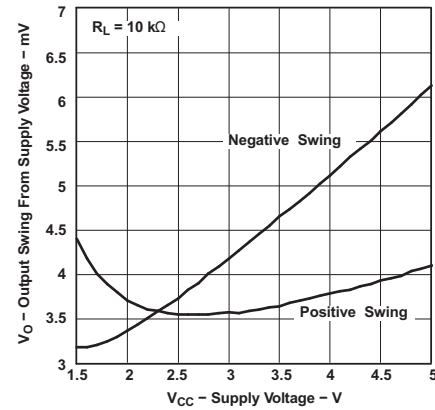

Figure 4. Output Voltage Swing vs Supply Voltage

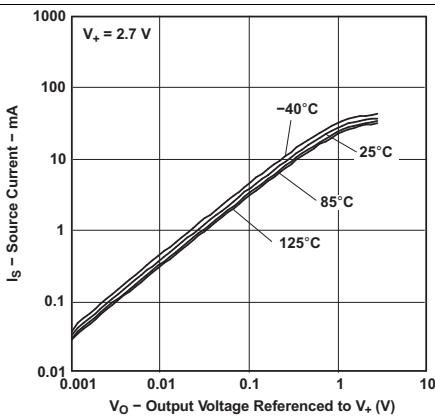

Figure 5. Source Current vs Output Voltage

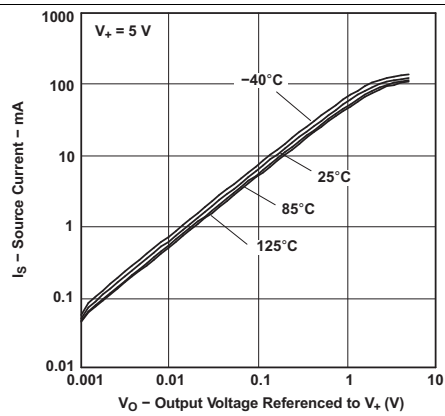
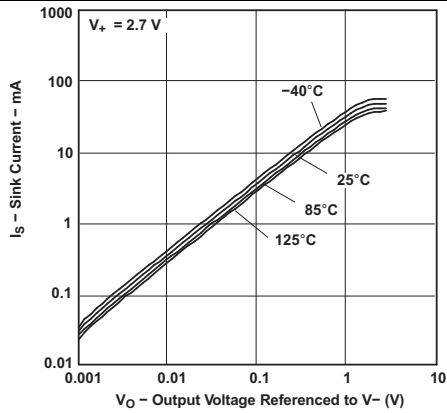
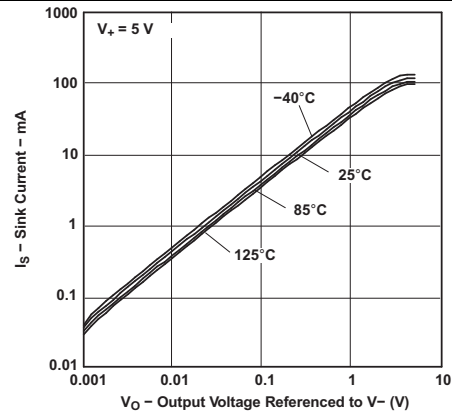
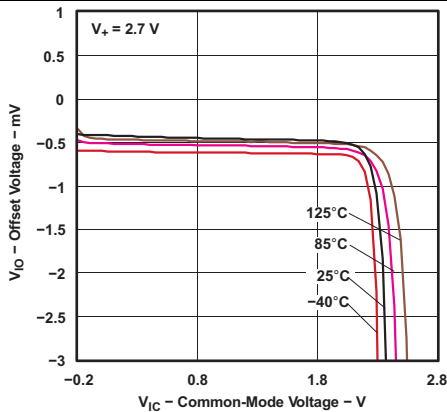
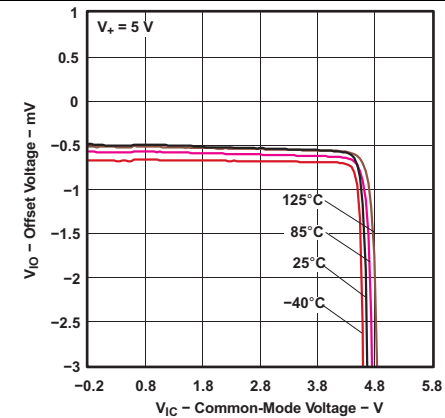
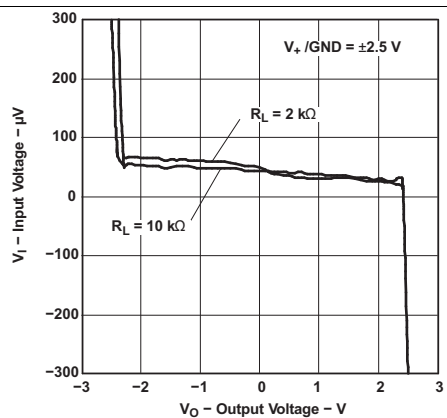
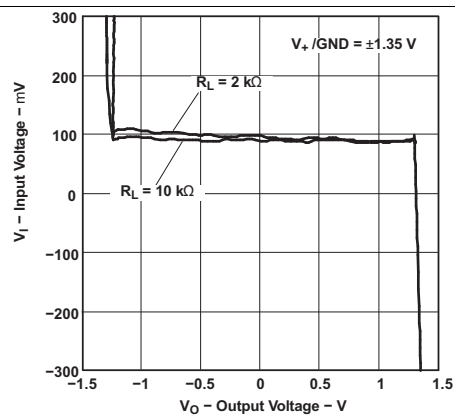

Figure 6. Source Current vs Output Voltage

Typical Characteristics (continued)

Figure 7. Sink Current vs Output Voltage

Figure 8. Sink Current vs Output Voltage

Figure 9. Offset Voltage vs Common-Mode Voltage

Figure 10. Offset Voltage vs Common-Mode Voltage

Figure 11. Input Voltage vs Output Voltage

Figure 12. Input Voltage vs Output Voltage

Typical Characteristics (continued)

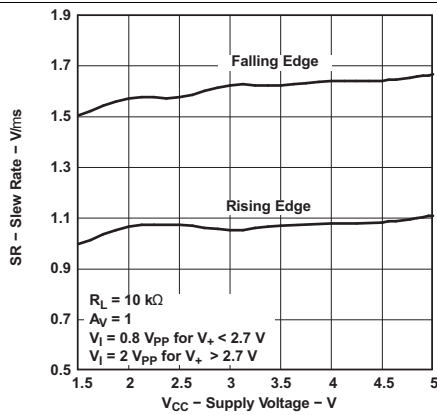

Figure 13. Slew Rate vs Supply Voltage

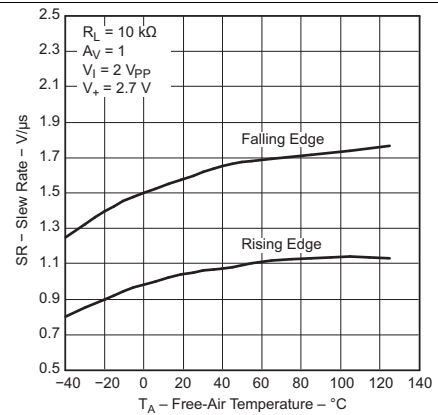

Figure 14. Slew Rate vs Temperature

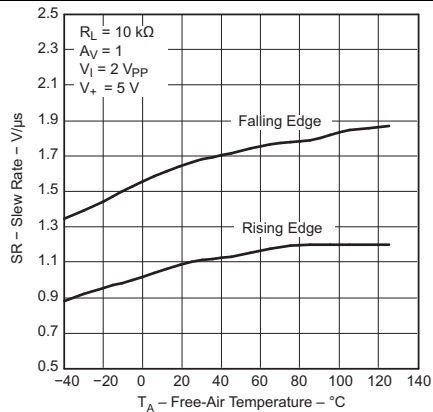

Figure 15. Slew Rate vs Temperature

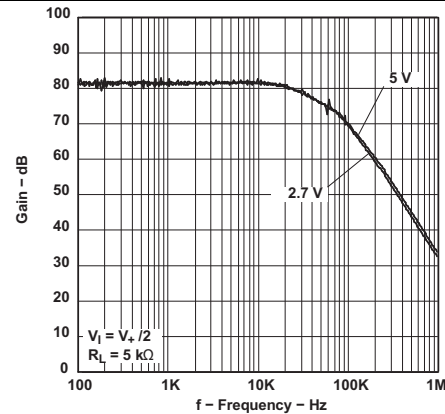

Figure 16. CMRR vs Frequency

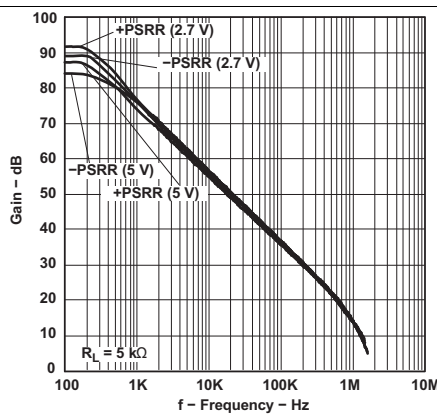

Figure 17. PSRR vs Frequency

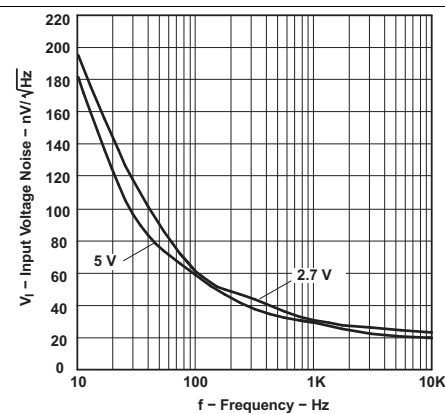
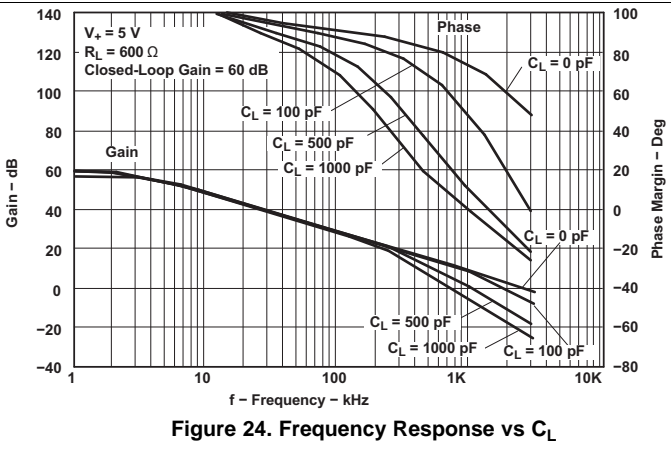
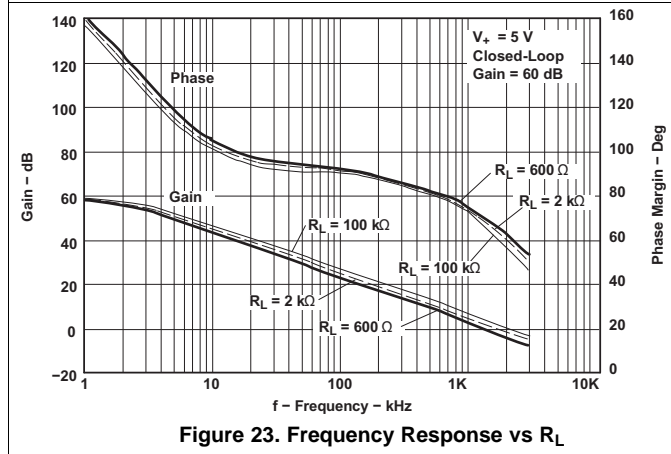
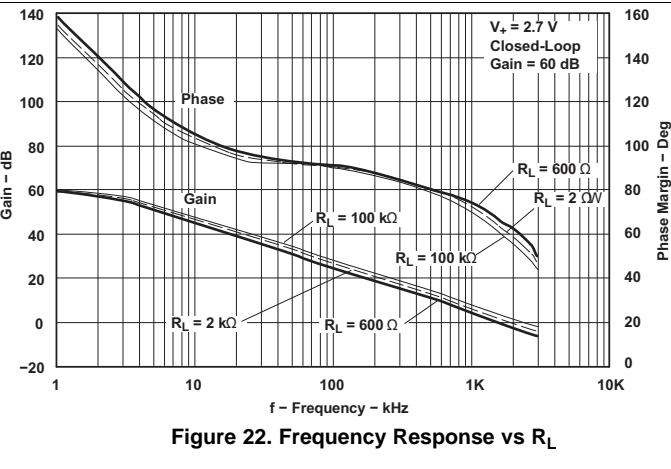
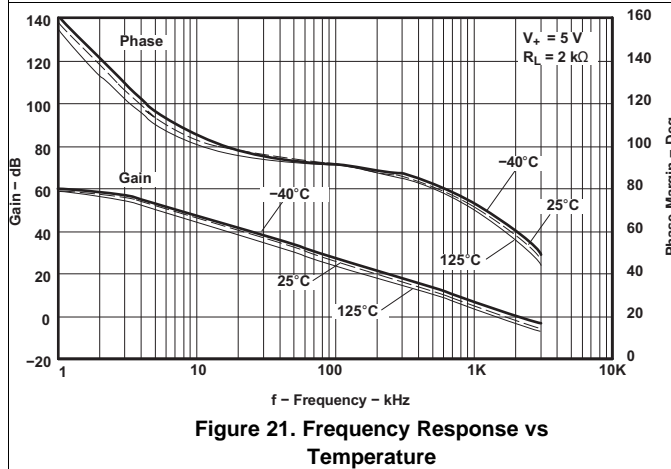
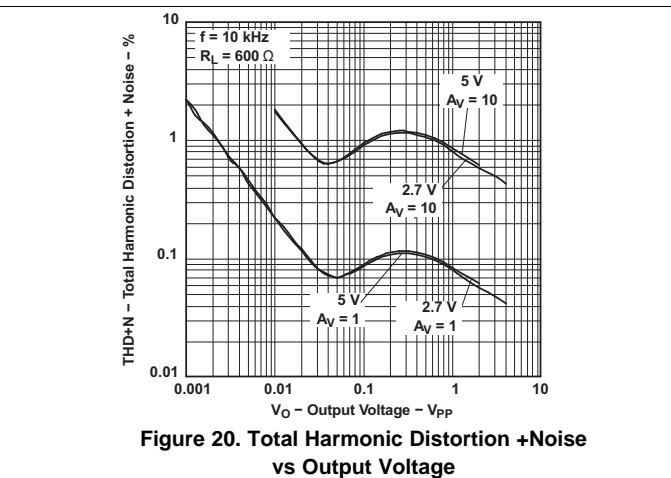
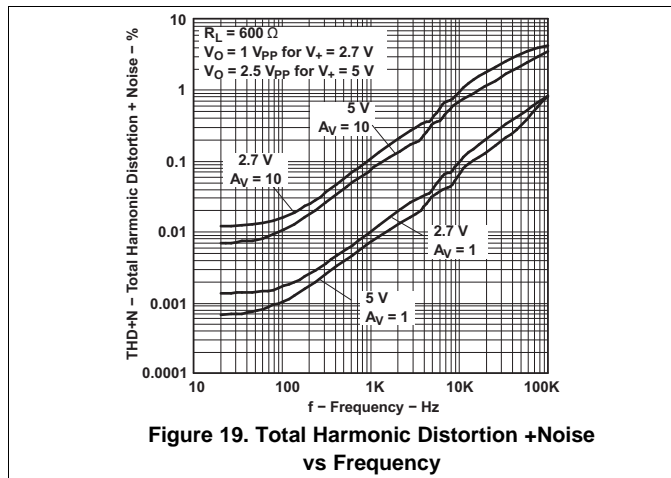
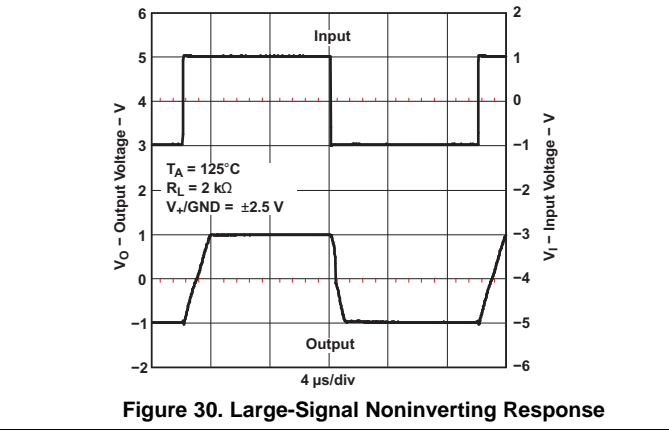
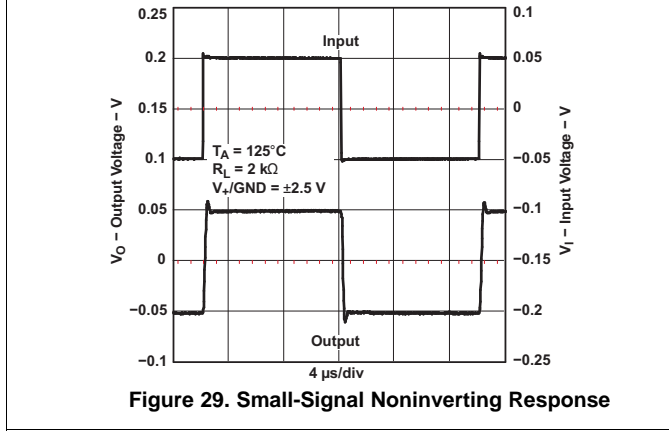
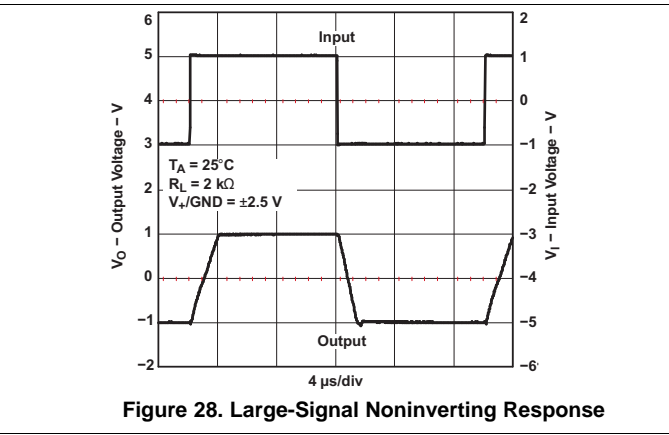
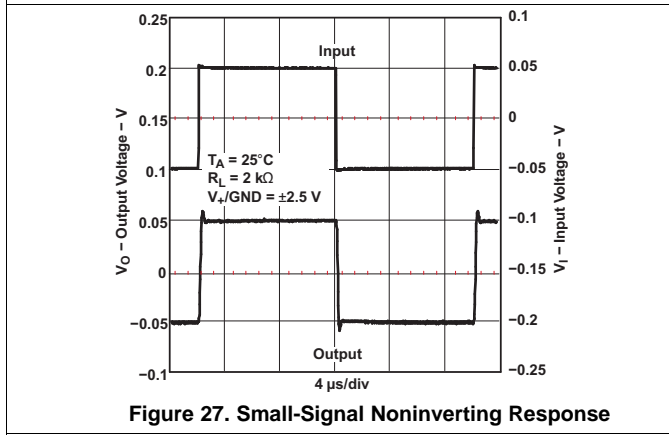
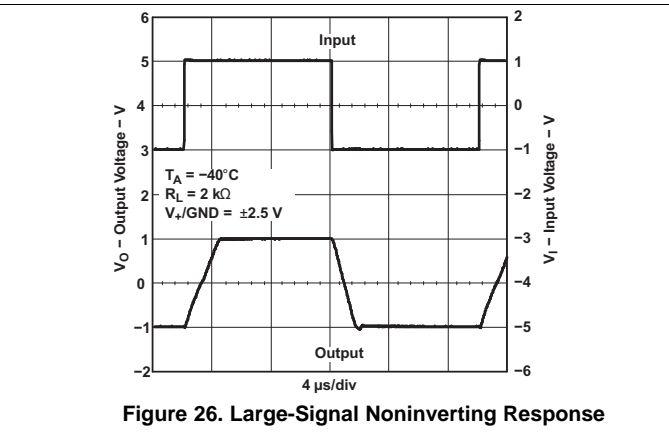
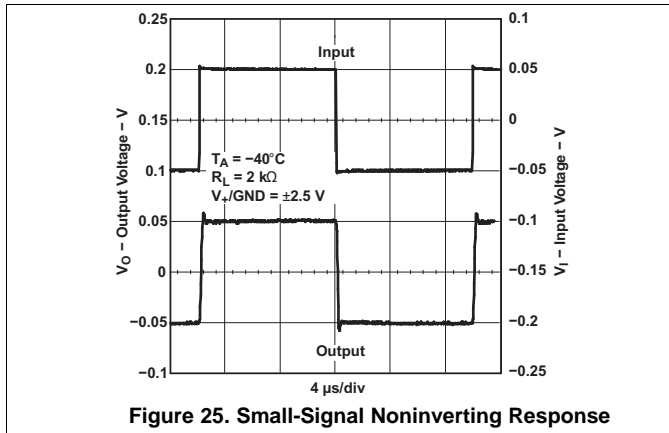

Figure 18. Input Voltage Noise vs Frequency

Typical Characteristics (continued)



Typical Characteristics (continued)

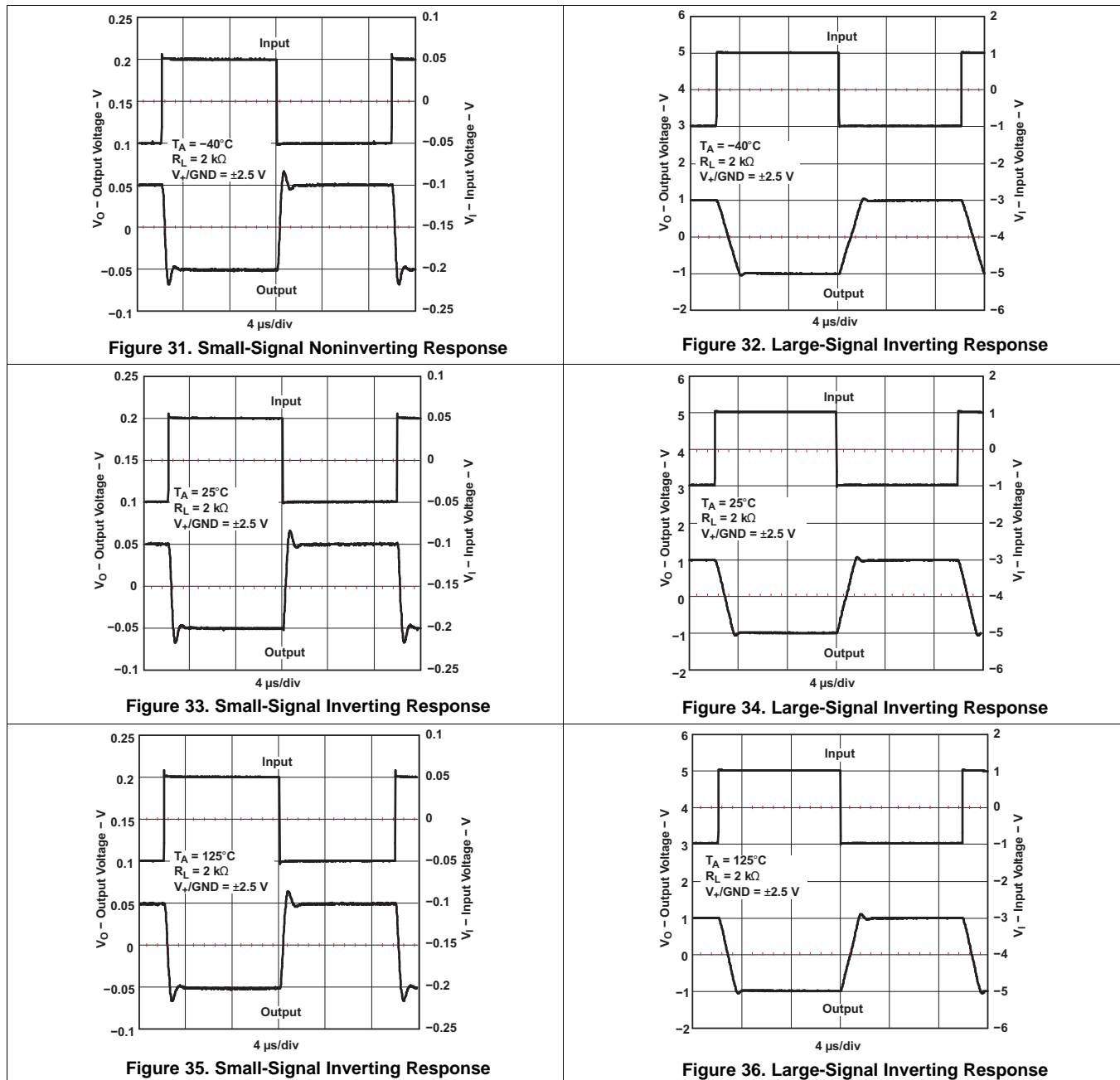

Typical Characteristics (continued)

7 Detailed Description

7.1 Overview

The TLV34xx devices are precision operational amplifiers with CMOS inputs for very low input bias current. Grade A devices offer lower V_{IO} for high accuracy in direct-coupled applications. Output is rail to rail and input common mode includes ground. TLV341 and TLV342S have shutdown mode for very low supply current.

7.2 Functional Block Diagram

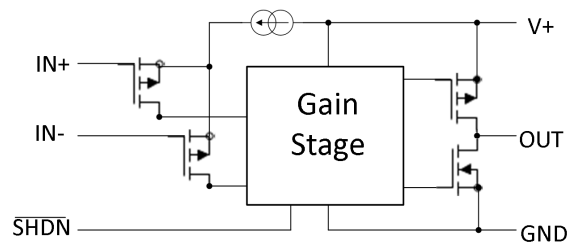

Copyright © 2016, Texas Instruments Incorporated

7.3 Feature Description

7.3.1 PMOS Input Stage

PMOS Input Stage supports a lower input range that includes ground. Upper range limit is $V_{CC} - 0.6\text{ V}$.

7.3.2 CMOS Output Stage

The CMOS drain output topology allows rail-to-rail output swing.

7.3.3 Shutdown

TLV341 and TLV342S include a shutdown pin. During shutdown, I_{CC} is nearly zero and the output becomes high impedance. The typical turnon time coming out of shutdown is 5 μs .

7.4 Device Functional Modes

The TLV34xx devices have two operation modes:

- Normal operation when $\overline{\text{SHDN}}$ pin is at V_+ level or the $\overline{\text{SHDN}}$ pin is not present
- Shutdown mode when $\overline{\text{SHDN}}$ is at GND level; I_{CC} is very low and output is high impedance.

8 Application and Implementation

NOTE

Information in the following applications sections is not part of the TI component specification, and TI does not warrant its accuracy or completeness. TI's customers are responsible for determining suitability of components for their purposes. Customers should validate and test their design implementation to confirm system functionality.

8.1 Application Information

The TLV34xx devices have rail-to-rail output and input range from ground to $V_{CC} - 0.6\text{ V}$. CMOS inputs provide very low input current. Shutdown capability is an option in dual amplifier version. Operation from 1.5 V to 5.5 V is possible.

8.2 Typical Application

A typical application for an operational amplifier in an inverting amplifier. This amplifier takes a positive voltage on the input, and makes it a negative voltage of the same magnitude. In the same manner, it also makes negative voltages positive.

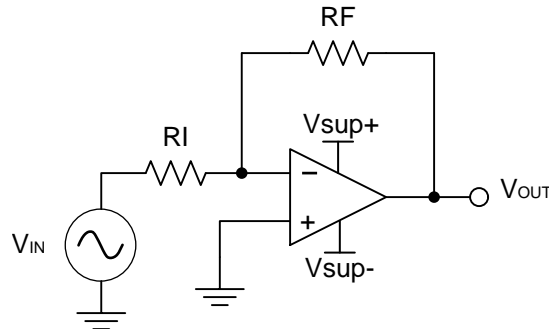

Copyright © 2016, Texas Instruments Incorporated

Figure 37. Application Schematic

8.2.1 Design Requirements

The supply voltage must be chosen such that it is larger than the input voltage range and output voltage range. For instance, this application scales a signal of $\pm 0.5\text{ V}$ to $\pm 1.8\text{ V}$. Setting the supply at $\pm 2\text{ V}$ is sufficient to accommodate this application. The supplies can power up in any order; however, neither supply can be of opposite polarity relative to ground at any time; otherwise, a large current can flow through the input ESD diodes. TI highly recommends adding a series resistor to the grounded input to limit current in such an occurrence. V_{sup+} must be more positive than V_{sup-} at all times; otherwise, a large reverse supply current may flow.

8.2.2 Detailed Design Procedure

Determine the gain required by the inverting amplifier using [Equation 1](#) and [Equation 2](#):

$$A_v = \frac{V_{OUT}}{V_{IN}} \quad (1)$$

$$A_v = \frac{1.8}{-0.5} = -3.6 \quad (2)$$

Once the desired gain is determined, choose a value for R_I or R_F . Choosing a value in the $k\Omega$ range is desirable because the amplifier circuit uses currents in the mA range. This ensures the part does not draw too much current. For this example, choose $10\text{ k}\Omega$ for R_I , which means $36\text{ k}\Omega$ is used for R_F . This was determined by [Equation 3](#).

$$A_v = -\frac{R_F}{R_I} \quad (3)$$

Typical Application (continued)

8.2.3 Application Curve

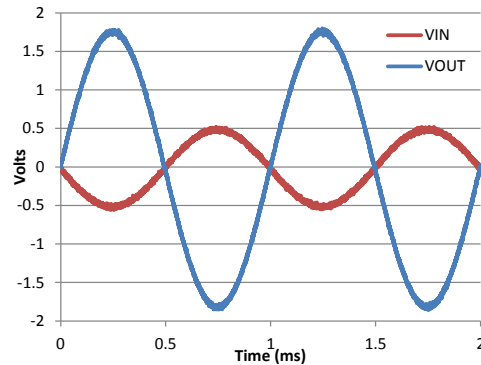

Figure 38. Input and Output Voltages of the Inverting Amplifier

9 Power Supply Recommendations

CAUTION

Supply voltages larger than 5.5 V for a single supply can permanently damage the device (see the [Absolute Maximum Ratings](#)).

Place 0.1- μ F bypass capacitors close to the power-supply pins to reduce errors coupling in from noisy or high-impedance power supplies.

10 Layout

10.1 Layout Guidelines

For best operational performance of the device, use good PCB layout practices, including:

- Noise can propagate into analog circuitry through the power pins of the circuit as a whole, as well as the operational amplifier. Bypass capacitors are used to reduce the coupled noise by providing low-impedance power sources local to the analog circuitry.
 - Connect low-ESR, 0.1- μ F ceramic bypass capacitors between each supply pin and ground, placed as close to the device as possible. A single bypass capacitor from V_+ to ground is applicable for single-supply applications.
- Separate grounding for analog and digital portions of circuitry is one of the simplest and most effective methods of noise suppression. One or more layers on multilayer PCBs are usually devoted to ground planes. A ground plane helps distribute heat and reduces EMI noise pickup. Make sure to physically separate digital and analog grounds while paying attention to the flow of the ground current.
- To reduce parasitic coupling, run the input traces as far away from the supply or output traces as possible. If it is not possible to keep them separate, it is much better to cross the sensitive trace perpendicular as opposed to in parallel with the noisy trace.
- Place the external components as close to the device as possible. Keeping R_F and R_G close to the inverting input minimizes parasitic capacitance, as shown in [Layout Guidelines](#).
- Keep the length of input traces as short as possible. Always remember that the input traces are the most sensitive part of the circuit.
- Consider a driven, low-impedance guard ring around the critical traces. A guard ring can significantly reduce leakage currents from nearby traces that are at different potentials.

10.2 Layout Example

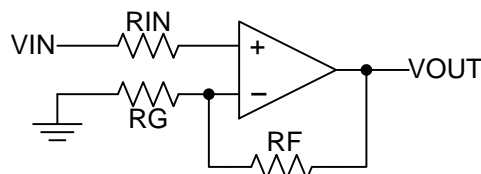

Figure 39. Layout Schematic

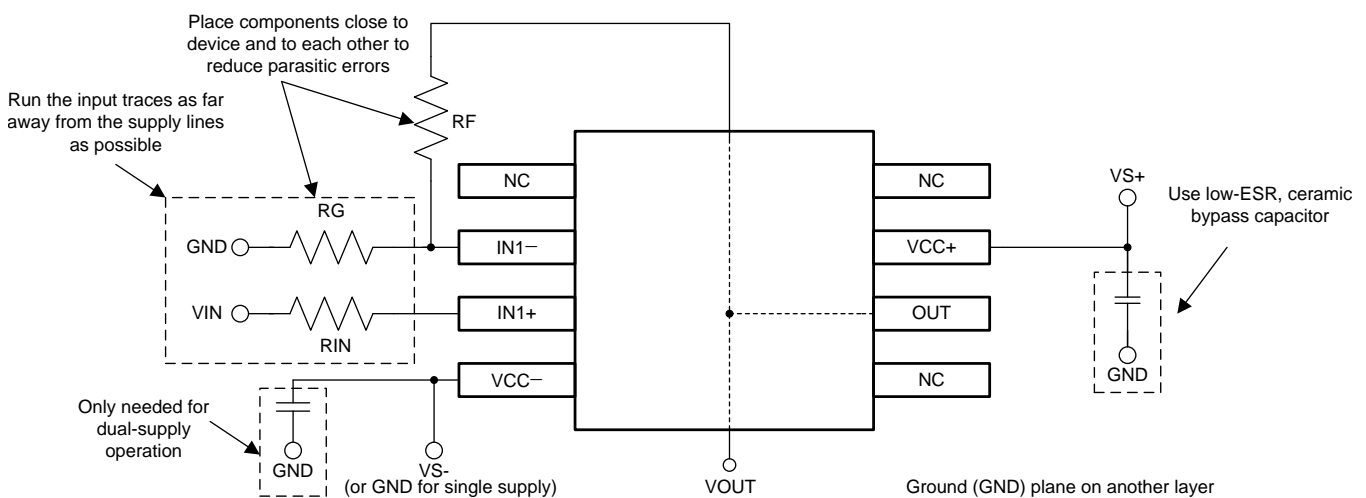

Figure 40. Operational Amplifier Schematic for Noninverting Configuration

11 Device and Documentation Support

11.1 Related Links

The table below lists quick access links. Categories include technical documents, support and community resources, tools and software, and quick access to sample or buy.

Table 1. Related Links

PARTS	PRODUCT FOLDER	SAMPLE & BUY	TECHNICAL DOCUMENTS	TOOLS & SOFTWARE	SUPPORT & COMMUNITY
TLV341	Click here	Click here	Click here	Click here	Click here
TLV341A	Click here	Click here	Click here	Click here	Click here
TLV342	Click here	Click here	Click here	Click here	Click here
TLV342S	Click here	Click here	Click here	Click here	Click here

11.2 Community Resource

The following links connect to TI community resources. Linked contents are provided "AS IS" by the respective contributors. They do not constitute TI specifications and do not necessarily reflect TI's views; see TI's [Terms of Use](#).

TI E2E™ Online Community *TI's Engineer-to-Engineer (E2E) Community*. Created to foster collaboration among engineers. At e2e.ti.com, you can ask questions, share knowledge, explore ideas and help solve problems with fellow engineers.

Design Support *TI's Design Support* Quickly find helpful E2E forums along with design support tools and contact information for technical support.

11.3 Trademarks

E2E is a trademark of Texas Instruments.
All other trademarks are the property of their respective owners.

11.4 Electrostatic Discharge Caution



This integrated circuit can be damaged by ESD. Texas Instruments recommends that all integrated circuits be handled with appropriate precautions. Failure to observe proper handling and installation procedures can cause damage.

ESD damage can range from subtle performance degradation to complete device failure. Precision integrated circuits may be more susceptible to damage because very small parametric changes could cause the device not to meet its published specifications.

11.5 Glossary

[SLYZ022](#) — *TI Glossary*.

This glossary lists and explains terms, acronyms, and definitions.

12 Mechanical, Packaging, and Orderable Information

The following pages include mechanical, packaging, and orderable information. This information is the most current data available for the designated devices. This data is subject to change without notice and revision of this document. For browser-based versions of this data sheet, refer to the left-hand navigation.

PACKAGING INFORMATION

Orderable Device	Status (1)	Package Type	Package Drawing	Pins	Package Qty	Eco Plan (2)	Lead finish/ Ball material (6)	MSL Peak Temp (3)	Op Temp (°C)	Device Marking (4/5)	Samples
TLV341AIDBVR	ACTIVE	SOT-23	DBV	6	3000	RoHS & Green	NIPDAU	Level-1-260C-UNLIM	-40 to 125	YCGE	Samples
TLV341AIDBVT	LIFEBUY	SOT-23	DBV	6	250	RoHS & Green	NIPDAU	Level-1-260C-UNLIM	-40 to 125	YCGE	
TLV341AIDCKR	ACTIVE	SC70	DCK	6	3000	RoHS & Green	NIPDAU	Level-1-260C-UNLIM	-40 to 125	Y5E	Samples
TLV341AIDCKT	LIFEBUY	SC70	DCK	6	250	RoHS & Green	NIPDAU	Level-1-260C-UNLIM	-40 to 125	Y5E	
TLV341AIDCKTG4	LIFEBUY	SC70	DCK	6	250	RoHS & Green	NIPDAU	Level-1-260C-UNLIM	-40 to 125	Y5E	
TLV341IDBVR	ACTIVE	SOT-23	DBV	6	3000	RoHS & Green	NIPDAU	Level-1-260C-UNLIM	-40 to 125	YC9E	Samples
TLV341IDCKR	ACTIVE	SC70	DCK	6	3000	RoHS & Green	NIPDAU	Level-1-260C-UNLIM	-40 to 125	Y4E	Samples
TLV341IDCKT	LIFEBUY	SC70	DCK	6	250	RoHS & Green	NIPDAU	Level-1-260C-UNLIM	-40 to 125	Y4E	
TLV341IDRLR	ACTIVE	SOT-5X3	DRL	6	4000	RoHS & Green	NIPDAUJAG	Level-1-260C-UNLIM	-40 to 125	(Y4A, Y4W)	Samples
TLV342AID	LIFEBUY	SOIC	D	8	75	RoHS & Green	NIPDAU	Level-1-260C-UNLIM	-40 to 125	TY342A	
TLV342AIDR	ACTIVE	SOIC	D	8	2500	RoHS & Green	NIPDAU	Level-1-260C-UNLIM	-40 to 125	TY342A	Samples
TLV342ID	LIFEBUY	SOIC	D	8	75	RoHS & Green	NIPDAU	Level-1-260C-UNLIM	-40 to 125	TY342	
TLV342IDGKR	ACTIVE	VSSOP	DGK	8	2500	RoHS & Green	NIPDAU	Level-1-260C-UNLIM	-40 to 125	Y6A	Samples
TLV342IDR	ACTIVE	SOIC	D	8	2500	RoHS & Green	NIPDAU	Level-1-260C-UNLIM	-40 to 125	TY342	Samples
TLV342IRUGR	ACTIVE	X2QFN	RUG	10	3000	RoHS & Green	NIPDAU	Level-1-260C-UNLIM	-40 to 125	Y6E	Samples
TLV342SIRUGR	ACTIVE	X2QFN	RUG	10	3000	RoHS & Green	NIPDAU	Level-1-260C-UNLIM	-40 to 125	2YE	Samples

(1) The marketing status values are defined as follows:

ACTIVE: Product device recommended for new designs.

LIFEBUY: TI has announced that the device will be discontinued, and a lifetime-buy period is in effect.

NRND: Not recommended for new designs. Device is in production to support existing customers, but TI does not recommend using this part in a new design.

PREVIEW: Device has been announced but is not in production. Samples may or may not be available.

OBSOLETE: TI has discontinued the production of the device.

(2) **RoHS:** TI defines "RoHS" to mean semiconductor products that are compliant with the current EU RoHS requirements for all 10 RoHS substances, including the requirement that RoHS substance do not exceed 0.1% by weight in homogeneous materials. Where designed to be soldered at high temperatures, "RoHS" products are suitable for use in specified lead-free processes. TI may reference these types of products as "Pb-Free".

RoHS Exempt: TI defines "RoHS Exempt" to mean products that contain lead but are compliant with EU RoHS pursuant to a specific EU RoHS exemption.

Green: TI defines "Green" to mean the content of Chlorine (Cl) and Bromine (Br) based flame retardants meet JS709B low halogen requirements of ≤ 1000 ppm threshold. Antimony trioxide based flame retardants must also meet the ≤ 1000 ppm threshold requirement.

(3) MSL, Peak Temp. - The Moisture Sensitivity Level rating according to the JEDEC industry standard classifications, and peak solder temperature.

(4) There may be additional marking, which relates to the logo, the lot trace code information, or the environmental category on the device.

(5) Multiple Device Markings will be inside parentheses. Only one Device Marking contained in parentheses and separated by a "~" will appear on a device. If a line is indented then it is a continuation of the previous line and the two combined represent the entire Device Marking for that device.

(6) Lead finish/Ball material - Orderable Devices may have multiple material finish options. Finish options are separated by a vertical ruled line. Lead finish/Ball material values may wrap to two lines if the finish value exceeds the maximum column width.

Important Information and Disclaimer: The information provided on this page represents TI's knowledge and belief as of the date that it is provided. TI bases its knowledge and belief on information provided by third parties, and makes no representation or warranty as to the accuracy of such information. Efforts are underway to better integrate information from third parties. TI has taken and continues to take reasonable steps to provide representative and accurate information but may not have conducted destructive testing or chemical analysis on incoming materials and chemicals. TI and TI suppliers consider certain information to be proprietary, and thus CAS numbers and other limited information may not be available for release.

In no event shall TI's liability arising out of such information exceed the total purchase price of the TI part(s) at issue in this document sold by TI to Customer on an annual basis.

TAPE AND REEL INFORMATION



QUADRANT ASSIGNMENTS FOR PIN 1 ORIENTATION IN TAPE



*All dimensions are nominal

Device	Package Type	Package Drawing	Pins	SPQ	Reel Diameter (mm)	Reel Width W1 (mm)	A0 (mm)	B0 (mm)	K0 (mm)	P1 (mm)	W (mm)	Pin1 Quadrant
TLV341AIDBVR	SOT-23	DBV	6	3000	180.0	8.4	3.2	3.2	1.4	4.0	8.0	Q3
TLV341AIDBVT	SOT-23	DBV	6	250	180.0	8.4	3.2	3.2	1.4	4.0	8.0	Q3
TLV341AIDCKR	SC70	DCK	6	3000	179.0	8.4	2.2	2.5	1.2	4.0	8.0	Q3
TLV341AIDCKT	SC70	DCK	6	250	179.0	8.4	2.2	2.5	1.2	4.0	8.0	Q3
TLV341IDBVR	SOT-23	DBV	6	3000	179.0	8.4	3.2	3.2	1.4	4.0	8.0	Q3
TLV341IDCKR	SC70	DCK	6	3000	179.0	8.4	2.2	2.5	1.2	4.0	8.0	Q3
TLV341IDCKT	SC70	DCK	6	250	179.0	8.4	2.2	2.5	1.2	4.0	8.0	Q3
TLV341IDRLR	SOT-5X3	DRL	6	4000	180.0	8.4	1.98	1.78	0.69	4.0	8.0	Q3
TLV342AIDR	SOIC	D	8	2500	330.0	12.4	6.4	5.2	2.1	8.0	12.0	Q1
TLV342IDGKR	VSSOP	DGK	8	2500	330.0	12.4	5.3	3.4	1.4	8.0	12.0	Q1
TLV342IDR	SOIC	D	8	2500	330.0	12.4	6.4	5.2	2.1	8.0	12.0	Q1
TLV342IRUGR	X2QFN	RUG	10	3000	179.0	8.4	1.75	2.25	0.65	4.0	8.0	Q1
TLV342SIRUGR	X2QFN	RUG	10	3000	179.0	8.4	1.75	2.25	0.65	4.0	8.0	Q1

TAPE AND REEL BOX DIMENSIONS

*All dimensions are nominal

Device	Package Type	Package Drawing	Pins	SPQ	Length (mm)	Width (mm)	Height (mm)
TLV341AIDBVR	SOT-23	DBV	6	3000	200.0	183.0	25.0
TLV341AIDBVT	SOT-23	DBV	6	250	203.0	203.0	35.0
TLV341AIDCKR	SC70	DCK	6	3000	200.0	183.0	25.0
TLV341AIDCKT	SC70	DCK	6	250	203.0	203.0	35.0
TLV341IDBVR	SOT-23	DBV	6	3000	200.0	183.0	25.0
TLV341IDCKR	SC70	DCK	6	3000	200.0	183.0	25.0
TLV341IDCKT	SC70	DCK	6	250	200.0	183.0	25.0
TLV341IDRLR	SOT-5X3	DRL	6	4000	202.0	201.0	28.0
TLV342AIDR	SOIC	D	8	2500	340.5	336.1	25.0
TLV342IDGKR	VSSOP	DGK	8	2500	358.0	335.0	35.0
TLV342IDR	SOIC	D	8	2500	340.5	336.1	25.0
TLV342IRUGR	X2QFN	RUG	10	3000	200.0	183.0	25.0
TLV342SIRUGR	X2QFN	RUG	10	3000	200.0	183.0	25.0

TUBE

*All dimensions are nominal

Device	Package Name	Package Type	Pins	SPQ	L (mm)	W (mm)	T (μm)	B (mm)
TLV342AID	D	SOIC	8	75	507	8	3940	4.32
TLV342ID	D	SOIC	8	75	507	8	3940	4.32

DCK (R-PDSO-G6)

PLASTIC SMALL-OUTLINE PACKAGE



- NOTES:
- A. All linear dimensions are in millimeters.
 - B. This drawing is subject to change without notice.
 - C. Body dimensions do not include mold flash or protrusion. Mold flash and protrusion shall not exceed 0.15 per side.
 - D. Falls within JEDEC MO-203 variation AB.

DCK (R-PDSO-G6)

PLASTIC SMALL OUTLINE



- NOTES:
- All linear dimensions are in millimeters.
 - This drawing is subject to change without notice.
 - Customers should place a note on the circuit board fabrication drawing not to alter the center solder mask defined pad.
 - Publication IPC-7351 is recommended for alternate designs.
 - Laser cutting apertures with trapezoidal walls and also rounding corners will offer better paste release. Customers should contact their board assembly site for stencil design recommendations. Example stencil design based on a 50% volumetric metal load solder paste. Refer to IPC-7525 for other stencil recommendations.

RUG (R-PQFP-N10)

PLASTIC QUAD FLATPACK

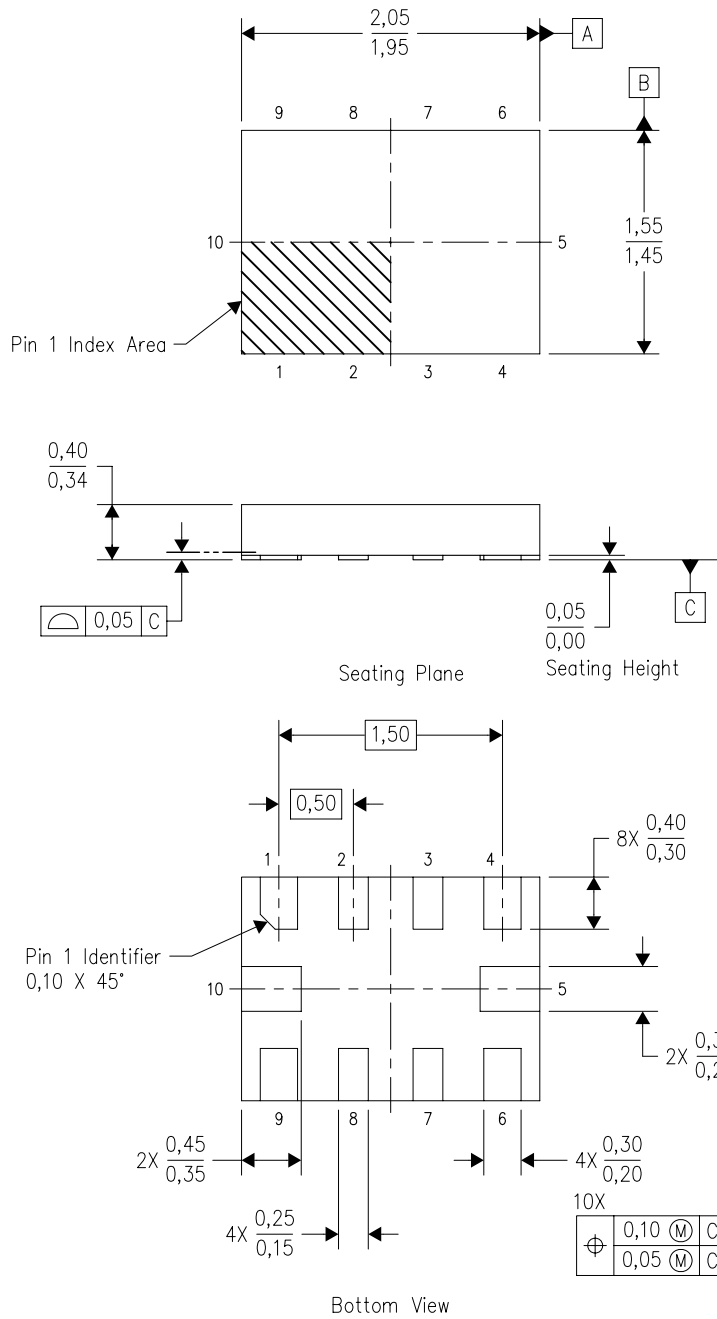

4208528-3/B 04/2008

- NOTES:
- A. All linear dimensions are in millimeters. Dimensioning and tolerancing per ASME Y14.5M-1994.
 - B. This drawing is subject to change without notice.
 - C. QFN (Quad Flatpack No-Lead) package configuration.
 - D. This package complies to JEDEC MO-288 variation X2EFD.

RUG (R-PQFP-N10)

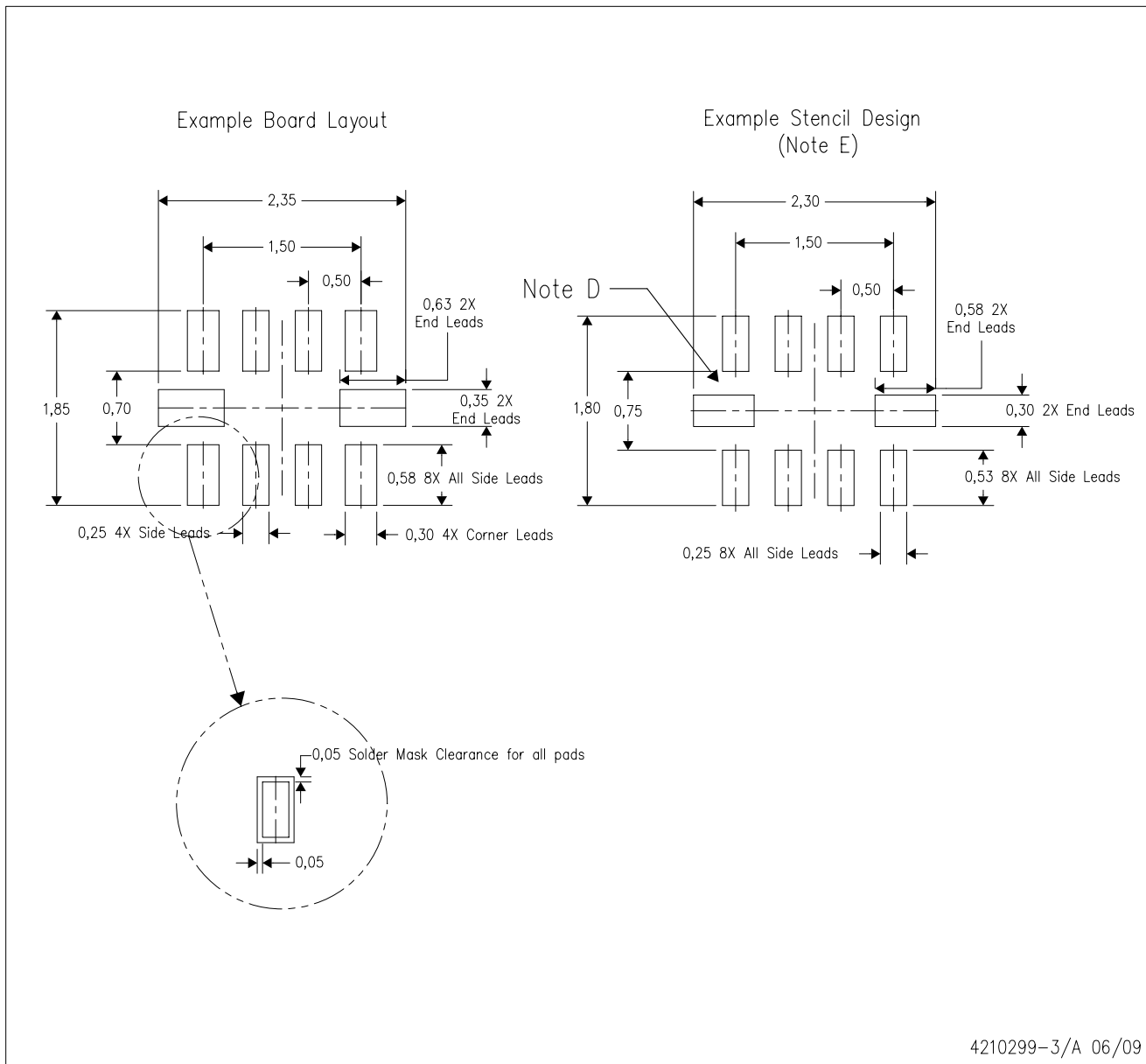

- NOTES:
- All linear dimensions are in millimeters.
 - This drawing is subject to change without notice.
 - Publication IPC-7351 is recommended for alternate designs.
 - Customers should contact their board fabrication site for minimum solder mask web tolerances between signal pads.
 - Maximum stencil thickness 0,127 mm (5 mils). All linear dimensions are in millimeters.
 - Laser cutting apertures with trapezoidal walls and also rounding corners will offer better paste release. Customers should contact their board assembly site for stencil design recommendations. Refer to IPC 7525 for stencil design considerations.
 - Side aperture dimensions over-print land for acceptable area ratio > 0.66. Customer may reduce side aperture dimensions if stencil manufacturing process allows for sufficient release at smaller opening.



D0008A

PACKAGE OUTLINE

SOIC - 1.75 mm max height

SMALL OUTLINE INTEGRATED CIRCUIT



4214825/C 02/2019

NOTES:

- Linear dimensions are in inches [millimeters]. Dimensions in parenthesis are for reference only. Controlling dimensions are in inches. Dimensioning and tolerancing per ASME Y14.5M.
- This drawing is subject to change without notice.
- This dimension does not include mold flash, protrusions, or gate burrs. Mold flash, protrusions, or gate burrs shall not exceed $.006$ [0.15] per side.
- This dimension does not include interlead flash.
- Reference JEDEC registration MS-012, variation AA.

EXAMPLE BOARD LAYOUT

D0008A

SOIC - 1.75 mm max height

SMALL OUTLINE INTEGRATED CIRCUIT



LAND PATTERN EXAMPLE
EXPOSED METAL SHOWN
SCALE:8X



SOLDER MASK DETAILS

4214825/C 02/2019

NOTES: (continued)

- 6. Publication IPC-7351 may have alternate designs.
- 7. Solder mask tolerances between and around signal pads can vary based on board fabrication site.

EXAMPLE STENCIL DESIGN

D0008A

SOIC - 1.75 mm max height

SMALL OUTLINE INTEGRATED CIRCUIT



SOLDER PASTE EXAMPLE
BASED ON .005 INCH [0.125 MM] THICK STENCIL
SCALE:8X

4214825/C 02/2019

NOTES: (continued)

8. Laser cutting apertures with trapezoidal walls and rounded corners may offer better paste release. IPC-7525 may have alternate design recommendations.
9. Board assembly site may have different recommendations for stencil design.

DBV0006A



PACKAGE OUTLINE

SOT-23 - 1.45 mm max height

SMALL OUTLINE TRANSISTOR



4214840/C 06/2021

NOTES:

1. All linear dimensions are in millimeters. Any dimensions in parenthesis are for reference only. Dimensioning and tolerancing per ASME Y14.5M.
2. This drawing is subject to change without notice.
3. Body dimensions do not include mold flash or protrusion. Mold flash and protrusion shall not exceed 0.25 per side.
4. Leads 1,2,3 may be wider than leads 4,5,6 for package orientation.
5. Reference JEDEC MO-178.

EXAMPLE BOARD LAYOUT

DBV0006A

SOT-23 - 1.45 mm max height

SMALL OUTLINE TRANSISTOR



LAND PATTERN EXAMPLE
EXPOSED METAL SHOWN
SCALE:15X

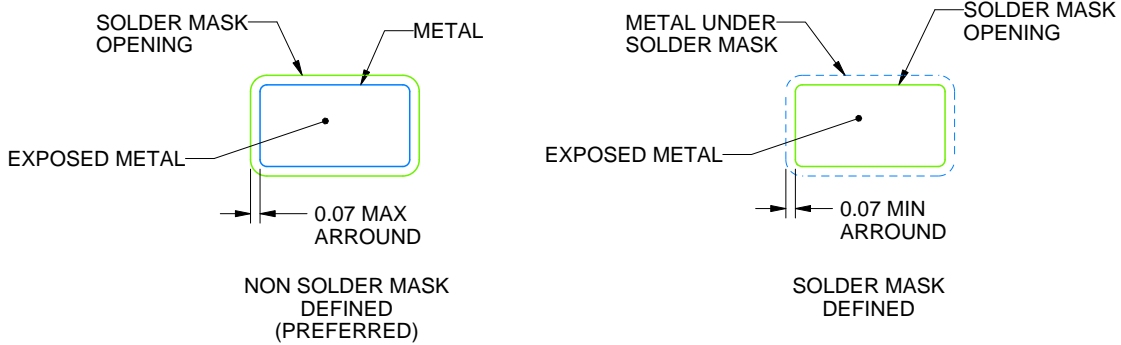

SOLDER MASK DETAILS

4214840/C 06/2021

NOTES: (continued)

6. Publication IPC-7351 may have alternate designs.

7. Solder mask tolerances between and around signal pads can vary based on board fabrication site.

EXAMPLE STENCIL DESIGN

DBV0006A

SOT-23 - 1.45 mm max height

SMALL OUTLINE TRANSISTOR



SOLDER PASTE EXAMPLE
BASED ON 0.125 mm THICK STENCIL
SCALE:15X

4214840/C 06/2021

NOTES: (continued)

8. Laser cutting apertures with trapezoidal walls and rounded corners may offer better paste release. IPC-7525 may have alternate design recommendations.
9. Board assembly site may have different recommendations for stencil design.

DGK (S-PDSO-G8)

PLASTIC SMALL-OUTLINE PACKAGE

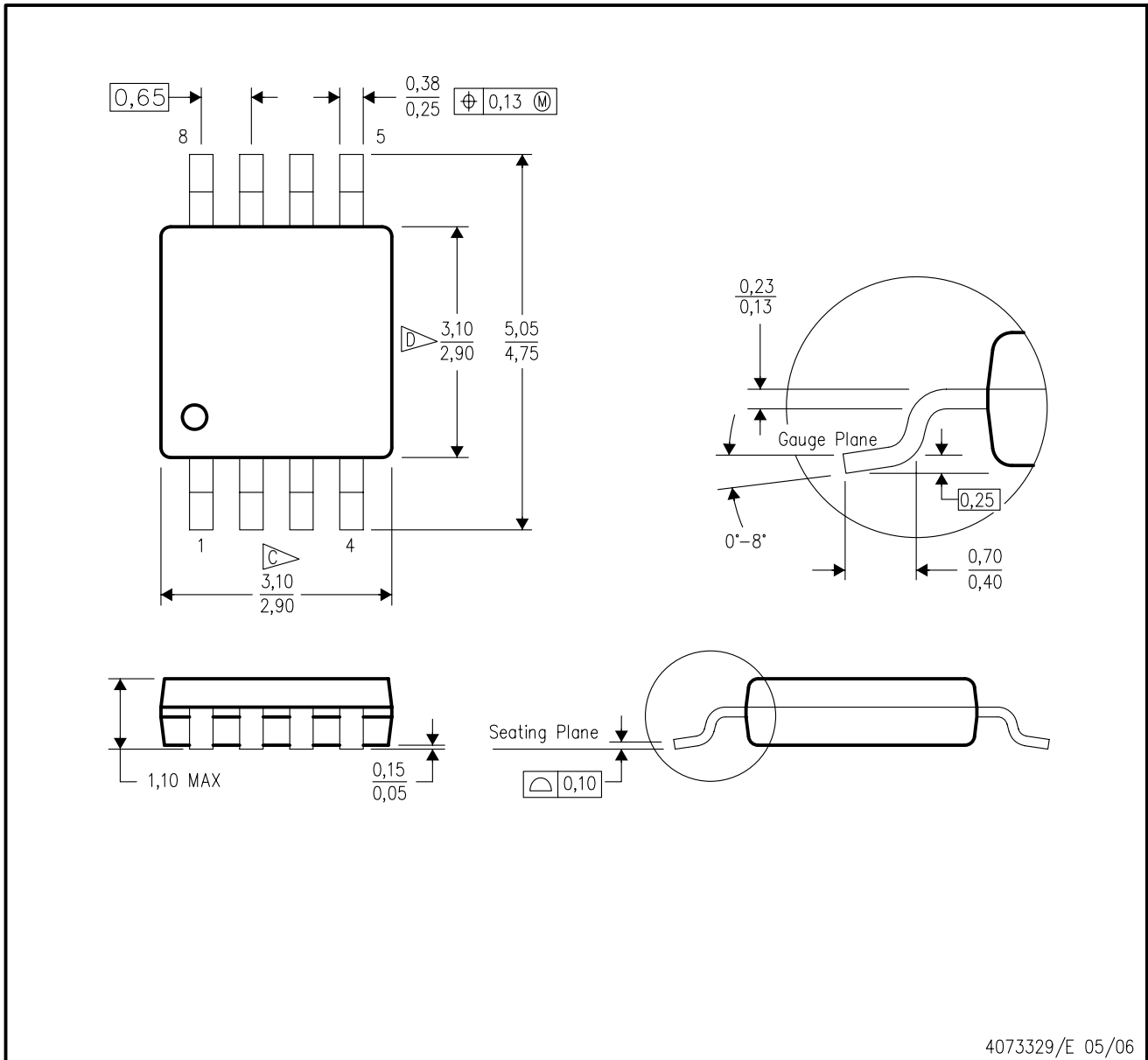

- NOTES:
- A. All linear dimensions are in millimeters.
 - B. This drawing is subject to change without notice.
 - C. Body length does not include mold flash, protrusions, or gate burrs. Mold flash, protrusions, or gate burrs shall not exceed 0.15 per end.
 - D. Body width does not include interlead flash. Interlead flash shall not exceed 0.50 per side.
 - E. Falls within JEDEC MO-187 variation AA, except interlead flash.

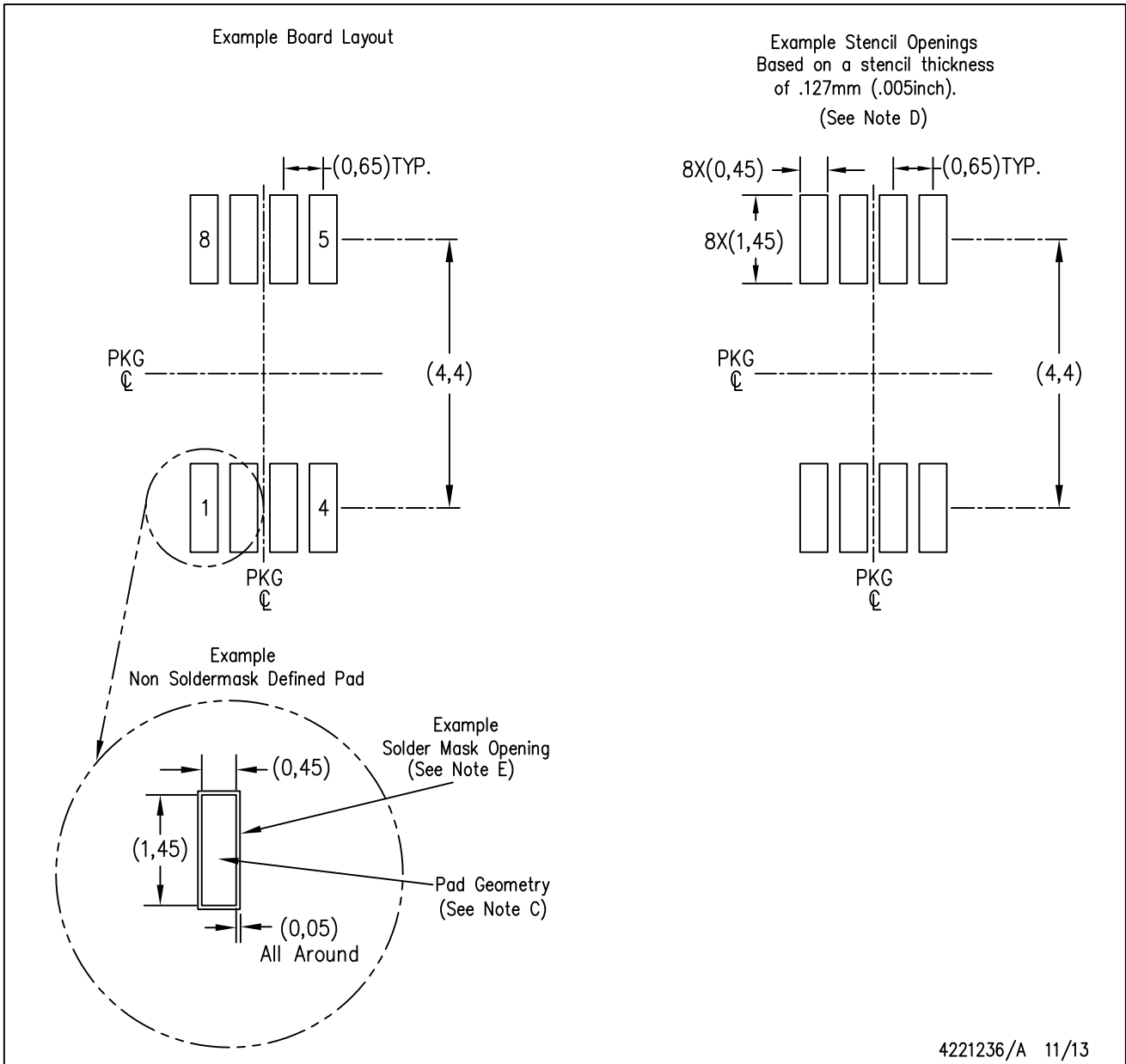

- NOTES:
- A. All linear dimensions are in millimeters.
 - B. This drawing is subject to change without notice.
 - C. Publication IPC-7351 is recommended for alternate designs.
 - D. Laser cutting apertures with trapezoidal walls and also rounding corners will offer better paste release. Customers should contact their board assembly site for stencil design recommendations. Refer to IPC-7525 for other stencil recommendations.
 - E. Customers should contact their board fabrication site for solder mask tolerances between and around signal pads.

DRL0006A

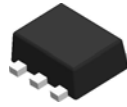

PACKAGE OUTLINE

SOT - 0.6 mm max height

PLASTIC SMALL OUTLINE

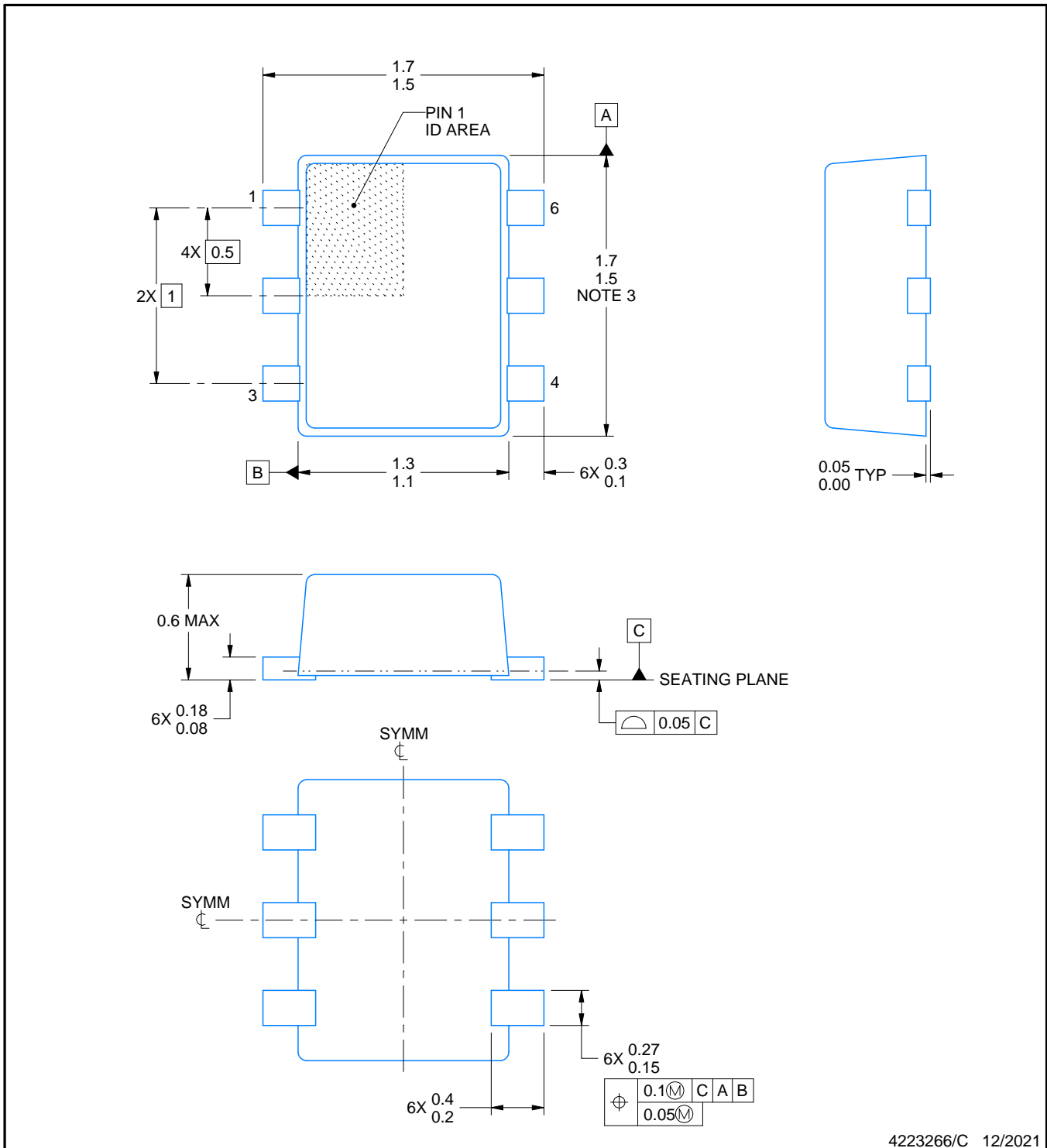

4223266/C 12/2021

NOTES:

1. All linear dimensions are in millimeters. Any dimensions in parenthesis are for reference only. Dimensioning and tolerancing per ASME Y14.5M.
2. This drawing is subject to change without notice.
3. This dimension does not include mold flash, protrusions, or gate burrs. Mold flash, protrusions, or gate burrs shall not exceed 0.15 mm per side.
4. Reference JEDEC registration MO-293 Variation UAAD

EXAMPLE BOARD LAYOUT

DRL0006A

SOT - 0.6 mm max height

PLASTIC SMALL OUTLINE

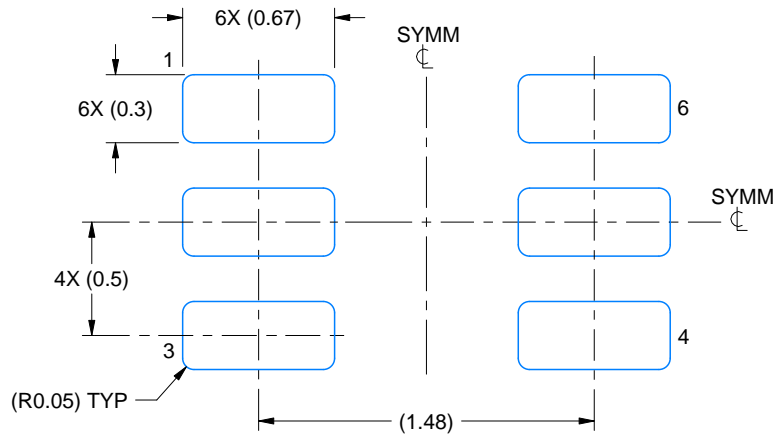

LAND PATTERN EXAMPLE
SCALE:30X

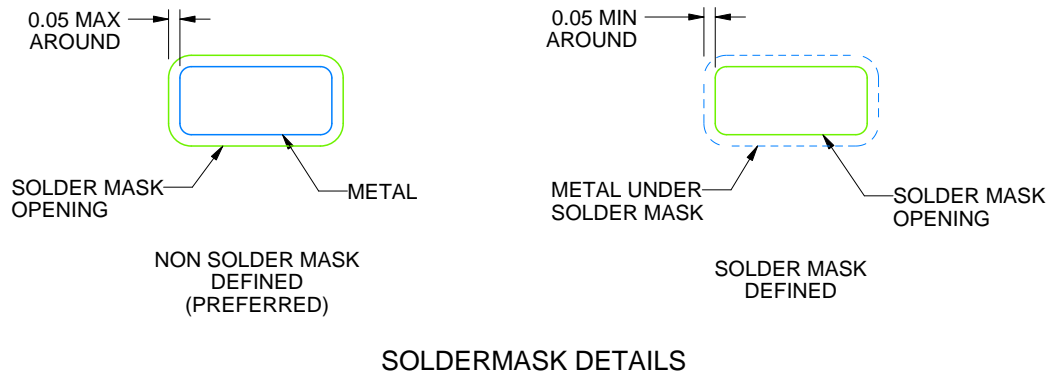

SOLDERMASK DETAILS

4223266/C 12/2021

NOTES: (continued)

5. Publication IPC-7351 may have alternate designs.
6. Solder mask tolerances between and around signal pads can vary based on board fabrication site.
7. Land pattern design aligns to IPC-610, Bottom Termination Component (BTC) solder joint inspection criteria.

EXAMPLE STENCIL DESIGN

DRL0006A

SOT - 0.6 mm max height

PLASTIC SMALL OUTLINE

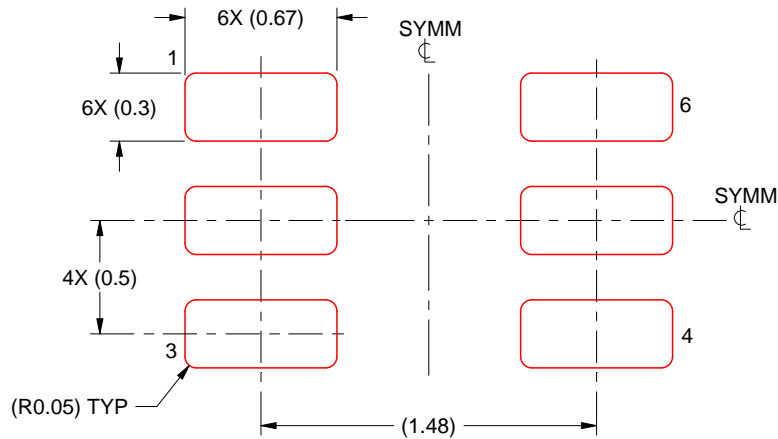

SOLDER PASTE EXAMPLE
BASED ON 0.1 mm THICK STENCIL
SCALE:30X

4223266/C 12/2021

NOTES: (continued)

8. Laser cutting apertures with trapezoidal walls and rounded corners may offer better paste release. IPC-7525 may have alternate design recommendations.
9. Board assembly site may have different recommendations for stencil design.

IMPORTANT NOTICE AND DISCLAIMER

TI PROVIDES TECHNICAL AND RELIABILITY DATA (INCLUDING DATA SHEETS), DESIGN RESOURCES (INCLUDING REFERENCE DESIGNS), APPLICATION OR OTHER DESIGN ADVICE, WEB TOOLS, SAFETY INFORMATION, AND OTHER RESOURCES "AS IS" AND WITH ALL FAULTS, AND DISCLAIMS ALL WARRANTIES, EXPRESS AND IMPLIED, INCLUDING WITHOUT LIMITATION ANY IMPLIED WARRANTIES OF MERCHANTABILITY, FITNESS FOR A PARTICULAR PURPOSE OR NON-INFRINGEMENT OF THIRD PARTY INTELLECTUAL PROPERTY RIGHTS.

These resources are intended for skilled developers designing with TI products. You are solely responsible for (1) selecting the appropriate TI products for your application, (2) designing, validating and testing your application, and (3) ensuring your application meets applicable standards, and any other safety, security, regulatory or other requirements.

These resources are subject to change without notice. TI grants you permission to use these resources only for development of an application that uses the TI products described in the resource. Other reproduction and display of these resources is prohibited. No license is granted to any other TI intellectual property right or to any third party intellectual property right. TI disclaims responsibility for, and you will fully indemnify TI and its representatives against, any claims, damages, costs, losses, and liabilities arising out of your use of these resources.

TI's products are provided subject to [TI's Terms of Sale](#) or other applicable terms available either on [ti.com](https://www.ti.com) or provided in conjunction with such TI products. TI's provision of these resources does not expand or otherwise alter TI's applicable warranties or warranty disclaimers for TI products.

TI objects to and rejects any additional or different terms you may have proposed.

Mailing Address: Texas Instruments, Post Office Box 655303, Dallas, Texas 75265
Copyright © 2023, Texas Instruments Incorporated