

TLV700xx-Q1 200-mA Low- I_Q Low-Dropout Regulator for Portable Devices

1 Features

- Qualified for Automotive Applications
- AEC-Q100 Qualified With the Following Results:
 - Device Temperature Grade 1: -40°C to 125°C Ambient Operating Temperature Range
 - Device HBM ESD Classification Level H2
 - Device CDM ESD Classification Level C4B
- 2% Accuracy
- Low I_Q : 31 μA
- Fixed Output Voltages
 - TLV70033-Q1: 3.3 V
 - TLV70030-Q1: 3 V
 - TLV70025-Q1: 2.5 V
 - TLV70012A-Q1: 1.2 V
- High PSRR: 68 dB at 1 kHz
- Stable With Effective Capacitance of 0.1 μF
- Thermal Shutdown and Overcurrent Protection
- Latch-Up Performance Meets 100 mA Per AEC-Q100, Level I
- Available in the SOT-5 (DDC) and SC70-5 (DCK) Packages

2 Applications

Automotive Second-Stage Power Supply

3 Description

The TLV700xx-Q1 family of low-dropout (LDO) linear regulators are low-quiescent-current devices with excellent line- and load-transient performance. These LDOs are designed for power-sensitive applications. A precision band-gap and error amplifier provides overall 2% accuracy. Low output noise, very high power-supply rejection ratio (PSRR), and low dropout voltage make this series of devices ideal for most battery-operated handheld equipment or for working as a second-stage power supply for connecting automotive battery applications. All device versions have thermal shutdown and current limit for safety.

Furthermore, these devices are stable with an effective output capacitance of only 0.1 μF . This feature enables the use of cost-effective capacitors that have higher bias voltages and temperature derating. The devices regulate to specified accuracy with no output load.

The TLV700xx-Q1 LDOs are available in the SOT-5 (DDC) and the SC70-5 (DCK) packages.

Device Information⁽¹⁾

| PART NUMBER | PACKAGE | BODY SIZE (NOM) |
|--------------|----------|-------------------|
| TLV70012A-Q1 | SC70 (5) | 2.00 mm x 1.25 mm |
| TLV70025-Q1 | SOT (5) | 2.90 mm x 1.60 mm |
| TLV70030-Q1 | SC70 (5) | 2.00 mm x 1.25 mm |
| TLV70033-Q1 | SOT (5) | 2.90 mm x 1.60 mm |

(1) For all available packages, see the orderable addendum at the end of the data sheet.

Typical Application Circuit (Fixed-Voltage Versions)

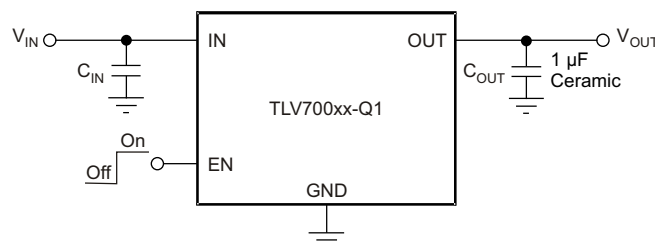

Copyright © 2016, Texas Instruments Incorporated



Table of Contents

| | | | |
|--|-----------|--|-----------|
| 1 Features | 1 | 7.4 Device Functional Modes..... | 11 |
| 2 Applications | 1 | 8 Application and Implementation | 12 |
| 3 Description | 1 | 8.1 Application Information..... | 12 |
| 4 Revision History | 2 | 8.2 Typical Application | 13 |
| 5 Pin Configuration and Functions | 3 | 9 Power Supply Recommendations | 14 |
| 6 Specifications | 3 | 10 Layout | 14 |
| 6.1 Absolute Maximum Ratings | 3 | 10.1 Layout Guidelines | 14 |
| 6.2 ESD Ratings..... | 3 | 10.2 Layout Example | 15 |
| 6.3 Recommended Operating Conditions..... | 4 | 11 Device and Documentation Support | 16 |
| 6.4 Thermal Information | 4 | 11.1 Related Links | 16 |
| 6.5 Electrical Characteristics..... | 4 | 11.2 Receiving Notification of Documentation Updates | 16 |
| 6.6 Typical Characteristics..... | 6 | 11.3 Community Resources..... | 16 |
| 7 Detailed Description | 10 | 11.4 Trademarks | 16 |
| 7.1 Overview | 10 | 11.5 Electrostatic Discharge Caution..... | 16 |
| 7.2 Functional Block Diagram | 10 | 11.6 Glossary | 16 |
| 7.3 Feature Description..... | 10 | 12 Mechanical, Packaging, and Orderable Information | 16 |

4 Revision History

NOTE: Page numbers for previous revisions may differ from page numbers in the current version.

| Changes from Revision G (September 2015) to Revision H | Page |
|---|-------------|
| Deleted all occurrences of TLV70028-Q1 and TLV70032-Q1 throughout the data sheet | 1 |
| Added an I/O column to the <i>Pin Functions</i> table | 3 |
| Added <i>Recommended Operating Conditions</i> table to the data sheet..... | 4 |
| Moved "High-ESR capacitors..." sentence here from the former <i>Board Layout Recommendations to Improve PSRR and Noise Performance</i> section 8.1.2 | 12 |
| Deleted the <i>Board Layout Recommendations to Improve PSRR and Noise Performance</i> section. Moved its non-redundant contents to <i>Input and Output Capacitor Requirements</i> or <i>Layout Guidelines</i> , as appropriate..... | 12 |
| Changed Z to R in the equations | 14 |
| Moved some layout information here from former Sectioni 8.1.2, <i>Board Layout Recommendations to Improve PSRR and Noise Performance</i> | 14 |
| Added the <i>Receiving Notification of Documentation Updates</i> section | 16 |

| Changes from Revision F (August 2013) to Revision G | Page |
|--|-------------|
| Added <i>Pin Configuration and Functions</i> section, <i>ESD Ratings</i> table, <i>Feature Description</i> section, <i>Device Functional Modes</i> , <i>Application and Implementation</i> section, <i>Power Supply Recommendations</i> section, <i>Layout</i> section, <i>Device and Documentation Support</i> section, and <i>Mechanical, Packaging, and Orderable Information</i> section | 1 |

| Changes from Revision E (January 2013) to Revision F | Page |
|---|-------------|
| Changed CDM classification level from C3B to C4B in FEATURES list..... | 1 |
| Changed Added T_j to the <i>Absolute Maximum Ratings</i> and moved T_A to the <i>Recommended Operating Conditions</i> | 3 |
| Changed Ground pin current (shutdown) max value from 2 to 2.5 in <i>Electrical Characteristics</i> table..... | 4 |
| Added TLV70028-Q1 and TLV70032-Q1 to document | 13 |

5 Pin Configuration and Functions

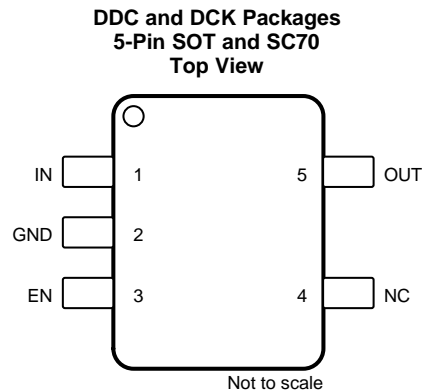

NC – No internal connection

Pin Functions

| PIN | | I/O | DESCRIPTION |
|------|-----|-----|--|
| NAME | NO. | | |
| EN | 3 | I | Enable pin. Driving EN over 0.9 V turns on the regulator. Driving EN below 0.4 V puts the regulator into shutdown mode and reduces operating current to 1 μ A, nominal. |
| IN | 1 | I | Input pin. A small 1- μ F ceramic capacitor is recommended from this pin to ground to assure stability and good transient performance. See Input and Output Capacitor Requirements in the <i>Application Information</i> section for more details. |
| GND | 2 | — | Ground pin |
| NC | 4 | — | No internal connection. This pin can be tied to ground to improve thermal dissipation. |
| OUT | 5 | O | Regulated output voltage pin. A small 1- μ F ceramic capacitor is needed from this pin to ground to assure stability. See Input and Output Capacitor Requirements in the <i>Application Information</i> section for more details. |

6 Specifications

6.1 Absolute Maximum Ratings

At $T_A = -40^\circ\text{C}$ to 125°C (unless otherwise noted). All voltages are with respect to GND.⁽¹⁾

| | | MIN | MAX | UNIT |
|-----------|-------------------------------|--------------------|-----|------------------|
| V_{IN} | Input voltage | -0.3 | 6 | V |
| V_{EN} | Enable voltage | -0.3 | 6 | V |
| V_{OUT} | Output voltage | -0.3 | 6 | V |
| I_{OUT} | Maximum output current | Internally limited | | |
| | Output short-circuit duration | Indefinite | | |
| T_J | Operating ambient temperature | -40 | 150 | $^\circ\text{C}$ |
| T_{stg} | Storage temperature | -55 | 150 | $^\circ\text{C}$ |

(1) Stresses beyond those listed under *Absolute Maximum Ratings* may cause permanent damage to the device. These are stress ratings only, which do not imply functional operation of the device at these or any other conditions beyond those indicated under *Recommended Operating Conditions*. Exposure to absolute-maximum-rated conditions for extended periods may affect device reliability.

6.2 ESD Ratings

| | | VALUE | UNIT |
|-------------|-------------------------|---|------------|
| $V_{(ESD)}$ | Electrostatic discharge | Human-body model (HBM), per AEC Q100-002 ⁽¹⁾ | ± 2000 |
| | | Charged-device model (CDM), per AEC Q100-011 | ± 750 |

(1) AEC Q100-002 indicates that HBM stressing shall be in accordance with the ANSI/ESDA/JEDEC JS-001 specification.

6.3 Recommended Operating Conditions

over operating free-air temperature range (unless otherwise noted)

| | | MIN | NOM | MAX | UNIT |
|------------------|-------------------------------|-----|-----|-----------------|------|
| V _{IN} | Input supply-voltage range | 2 | | 5.5 | V |
| V _{OUT} | Output voltage | 1.2 | | 4.8 | V |
| I _{OUT} | Output current | 0 | | 200 | mA |
| V _{EN} | Voltage on EN pin | 0 | | V _{IN} | V |
| T _A | Operating ambient temperature | –40 | | 125 | °C |

6.4 Thermal Information

| THERMAL METRIC ⁽¹⁾ | | TLV700xx-Q1 | | UNIT |
|-------------------------------|--|-------------|-----------|------|
| | | DCK (SOT) | DDC (SOT) | |
| | | 5 Pins | 5 PINS | |
| R _{θJA} | Junction-to-ambient thermal resistance | 307.6 | 262.8 | °C/W |
| R _{θJC(top)} | Junction-to-case (top) thermal resistance | 79.1 | 68.2 | °C/W |
| R _{θJB} | Junction-to-board thermal resistance | 93.7 | 81.6 | °C/W |
| ψ _{JT} | Junction-to-top characterization parameter | 1.3 | 1.1 | °C/W |
| ψ _{JB} | Junction-to-board characterization parameter | 92.8 | 80.9 | °C/W |
| R _{θJC(bot)} | Junction-to-case (bottom) thermal resistance | n/a | n/a | °C/W |

(1) For more information about traditional and new thermal metrics, see the *Semiconductor and IC Package Thermal Metrics* application report, [SPRA953](#).

6.5 Electrical Characteristics

V_{IN} = V_{OUT(TYP)} + 0.3 V or 2 V (whichever is greater); I_{OUT} = 10 mA, V_{EN} = V_{IN}, C_{OUT} = 1 μF, and T_A = –40°C to 125°C (unless otherwise noted). Typical values are at T_A = 25°C.

| PARAMETER | | TEST CONDITIONS | MIN | TYP | MAX | UNIT |
|-------------------------------------|--------------------------------|---|------------------------|------|-----------------|-------------------|
| V _{OUT} | DC output accuracy | –40°C ≤ T _A ≤ 125°C | V _{OUT} ≥ 1 V | –2% | 2% | |
| | | | V _{OUT} < 1 V | –20 | 20 | mV |
| ΔV _O / ΔV _{IN} | Line regulation | V _{OUT(NOM)} + 0.5 V ≤ V _{IN} ≤ 5.5 V I _{OUT} = 10 mA | | 1 | 5 | mV |
| ΔV _O / ΔI _{OUT} | Load regulation | 0 mA ≤ I _{OUT} ≤ 200 mA, TLV70025-Q1 TLV70030-Q1, TLV70033-Q1 | | | 15 | mV |
| | | 0 mA ≤ I _{OUT} ≤ 200 mA, TLV70012A-Q1 | | | 20 | |
| V _{DO} | Dropout voltage ⁽¹⁾ | V _{IN} = 0.98 × V _{OUT(NOM)} , I _{OUT} = 200 mA | | 175 | 250 | mV |
| I _{CL} | Output current limit | V _{OUT} = 0.9 × V _{OUT(NOM)} | 220 | 350 | 550 | mA |
| I _{GND} | Ground pin current | I _{OUT} = 0 mA | | 31 | 55 | μA |
| | | I _{OUT} = 200 mA, V _{IN} = V _{OUT} + 0.5 V | | 270 | | μA |
| I _{SHDN} | Ground pin current (shutdown) | V _{EN} ≤ 0.4 V, 2 V ≤ V _{IN} ≤ 4.5 V | | 1 | 2.5 | μA |
| PSRR | Power-supply rejection ratio | V _{IN} = 2.3 V, V _{OUT} = 1.8 V I _{OUT} = 10 mA, f = 1 kHz | | 68 | | dB |
| V _N | Output noise voltage | BW = 100 Hz to 100 kHz V _{IN} = 2.3 V, V _{OUT} = 1.8 V, I _{OUT} = 10 mA | | 48 | | μV _{RMS} |
| t _{STR} | Startup time ⁽²⁾ | C _{OUT} = 1 μF, I _{OUT} = 200 mA | | 100 | | μs |
| V _{EN(HI)} | Enable pin high (enabled) | | 0.9 | | V _{IN} | V |
| V _{EN(LO)} | Enable pin low (disabled) | | 0 | | 0.4 | V |
| I _{EN} | Enable pin current | V _{EN} = 5.5 V, I _{OUT} = 10 μA | | 0.04 | 0.5 | μA |
| UVLO | Undervoltage lockout | V _{IN} rising | | 1.9 | | V |

(1) V_{DO} is measured for devices with V_{OUT(NOM)} ≥ 2.35 V.

(2) Startup time = time from EN assertion to 0.98 × V_{OUT(NOM)}.

Electrical Characteristics (continued)

$V_{IN} = V_{OUT(TYP)} + 0.3\text{ V}$ or 2 V (whichever is greater); $I_{OUT} = 10\text{ mA}$, $V_{EN} = V_{IN}$, $C_{OUT} = 1\text{ }\mu\text{F}$, and $T_A = -40^\circ\text{C}$ to 125°C (unless otherwise noted). Typical values are at $T_A = 25^\circ\text{C}$.

| PARAMETER | | TEST CONDITIONS | MIN | TYP | MAX | UNIT |
|-----------------|-------------------------------|----------------------------------|-----|-----|-----|------|
| T _{SD} | Thermal shutdown temperature | Shutdown, temperature increasing | | 160 | | °C |
| | | Reset, temperature decreasing | | 140 | | °C |
| T _A | Operating ambient temperature | | -40 | | 125 | °C |

6.6 Typical Characteristics

$T_J = -40^\circ\text{C}$ to 125°C , $V_{IN} = V_{OUT(TYP)} + 0.5\text{ V}$ or 2 V (whichever is greater); $I_{OUT} = 10\text{ mA}$, $V_{EN} = V_{IN}$, $C_{OUT} = 1\text{ }\mu\text{F}$ (unless otherwise noted). Typical values are at $T_J = 25^\circ\text{C}$.

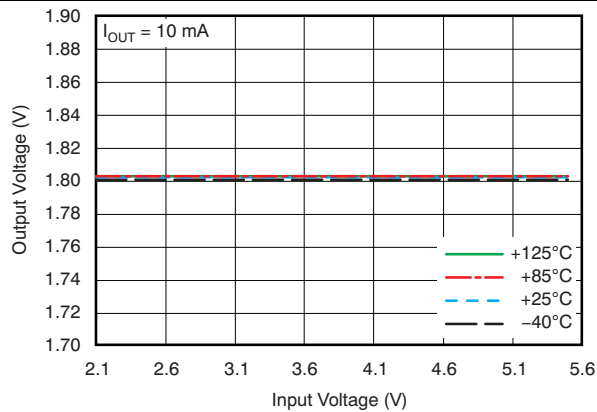

Figure 1. TLV700xx-Q1 Line Regulation

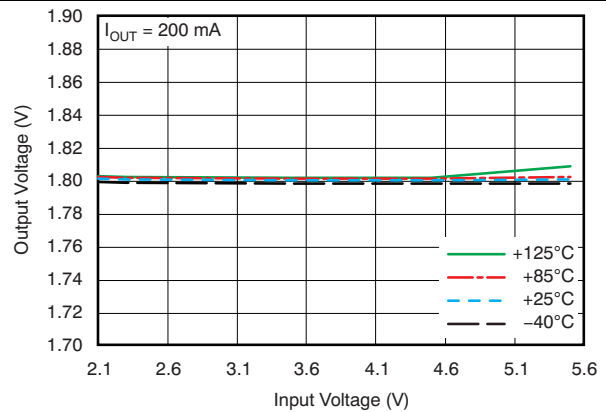

Figure 2. TLV700xx-Q1 Line Regulation

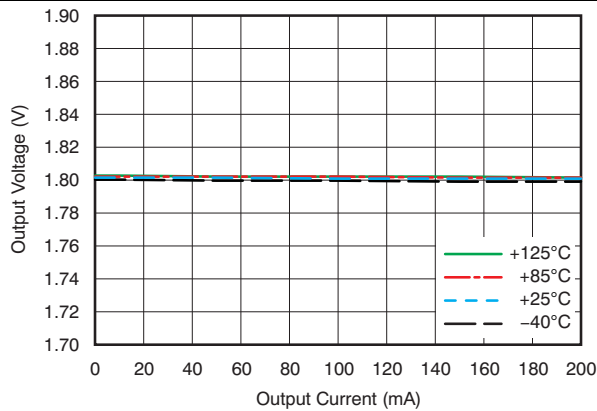

Figure 3. TLV700xx-Q1 Load Regulation

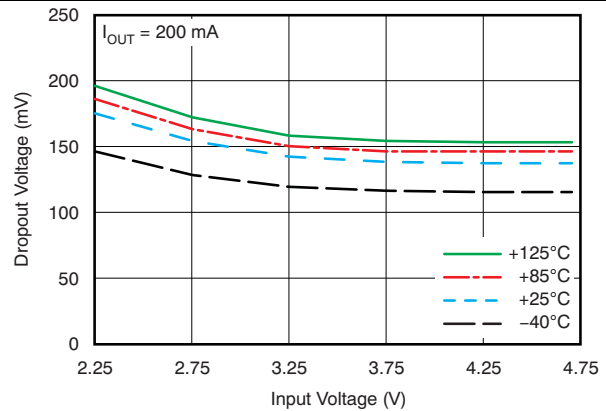

Figure 4. TLV700xx-Q1 Dropout Voltage vs Input Voltage

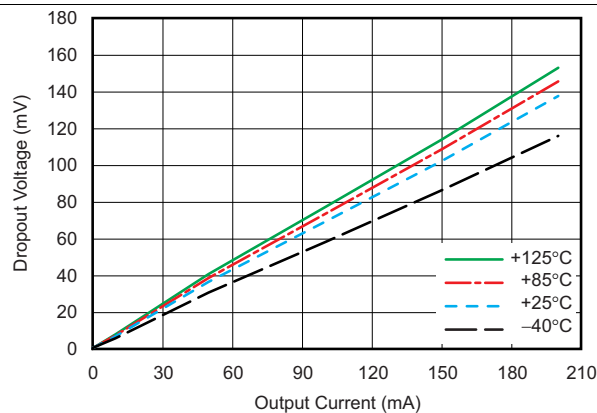

Figure 5. TLV700xx-Q1 Dropout Voltage vs Output Current

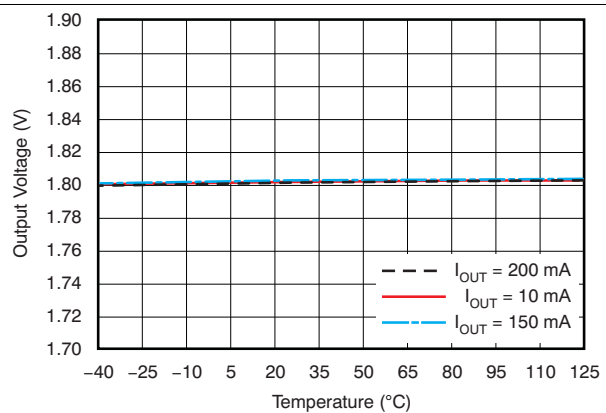

Figure 6. TLV700xx-Q1 Output Voltage vs Temperature

Typical Characteristics (continued)

$T_J = -40^\circ\text{C}$ to 125°C , $V_{IN} = V_{OUT(TYP)} + 0.5\text{ V}$ or 2 V (whichever is greater); $I_{OUT} = 10\text{ mA}$, $V_{EN} = V_{IN}$, $C_{OUT} = 1\ \mu\text{F}$ (unless otherwise noted). Typical values are at $T_J = 25^\circ\text{C}$.

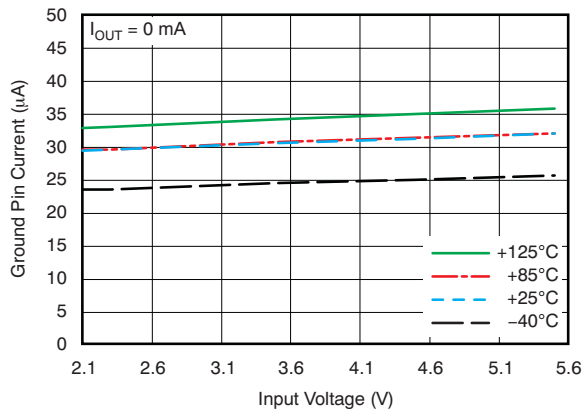

Figure 7. TLV700xx-Q1 Ground Pin Current vs Input Voltage

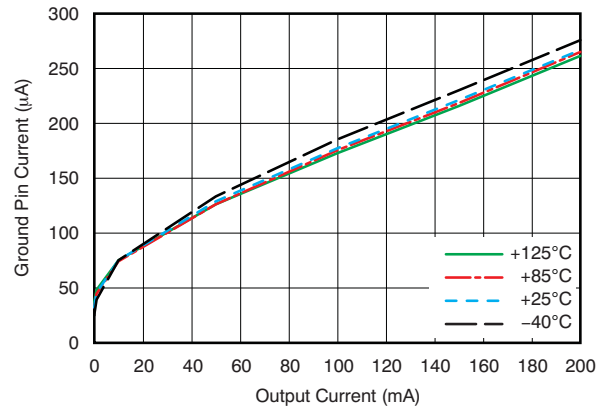

Figure 8. TLV700xx-Q1 Ground Pin Current vs Load

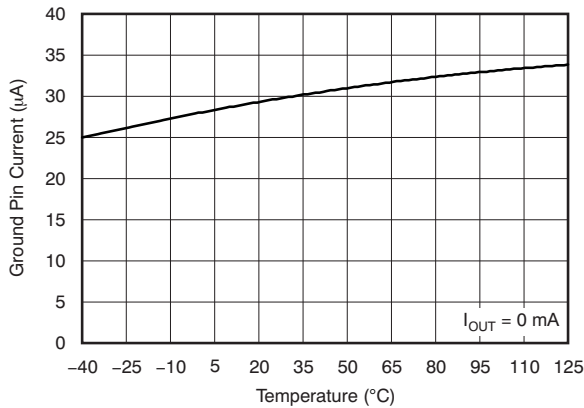

Figure 9. TLV70018 Ground Pin Current vs Temperature

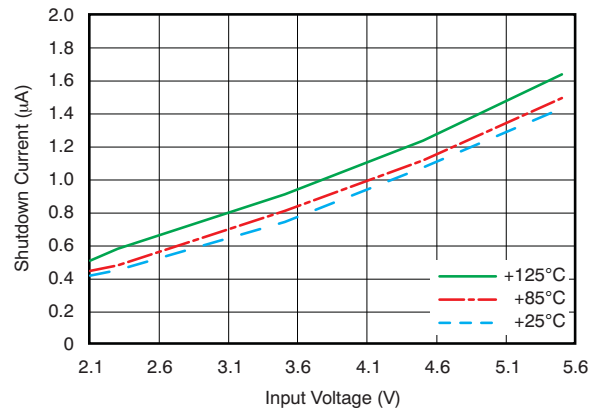

Figure 10. TLV700xx-Q1 Shutdown Current vs Input Voltage

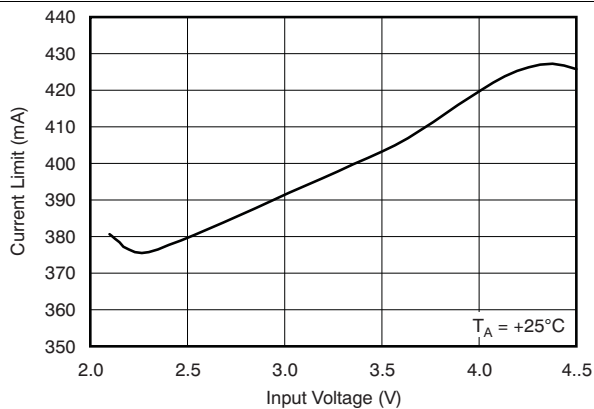

Figure 11. TLV700xx-Q1 Current Limit vs Input Voltage

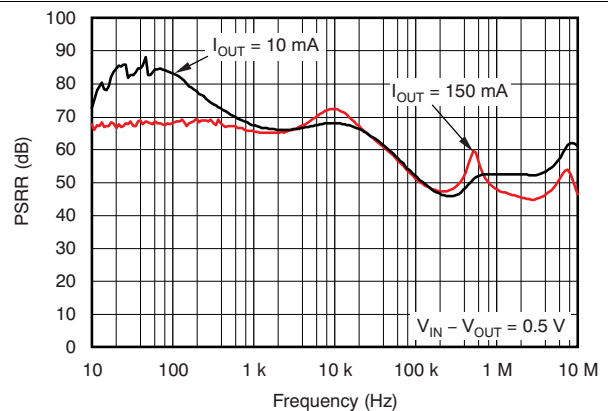

Figure 12. TLV700xx-Q1 Power-Supply Ripple Rejection vs Frequency

Typical Characteristics (continued)

$T_J = -40^{\circ}\text{C}$ to 125°C , $V_{IN} = V_{OUT(TYP)} + 0.5\text{ V}$ or 2 V (whichever is greater); $I_{OUT} = 10\text{ mA}$, $V_{EN} = V_{IN}$, $C_{OUT} = 1\text{ }\mu\text{F}$ (unless otherwise noted). Typical values are at $T_J = 25^{\circ}\text{C}$.

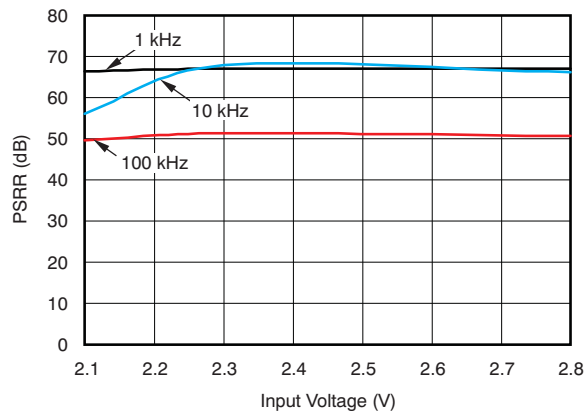

Figure 13. TLV700xx-Q1 Power-Supply Ripple Rejection vs Input Voltage

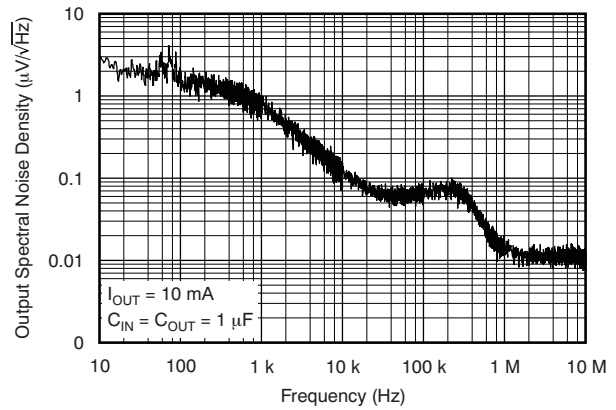

Figure 14. TLV700xx-Q1 Output Spectral Noise Density vs Output Voltage

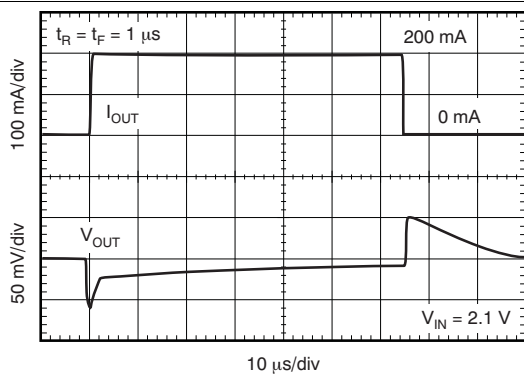

Figure 15. TLV700xx-Q1 Load Transient Response

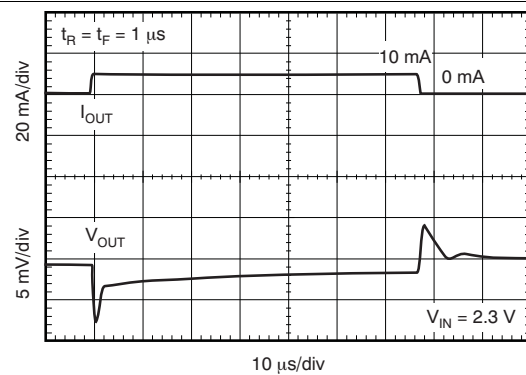

Figure 16. TLV700xx-Q1 Load Transient Response

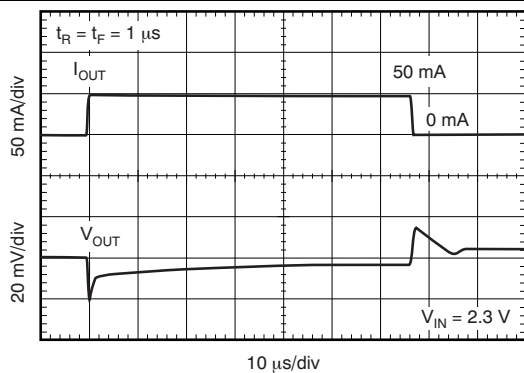

Figure 17. TLV700xx-Q1 Load Transient Response

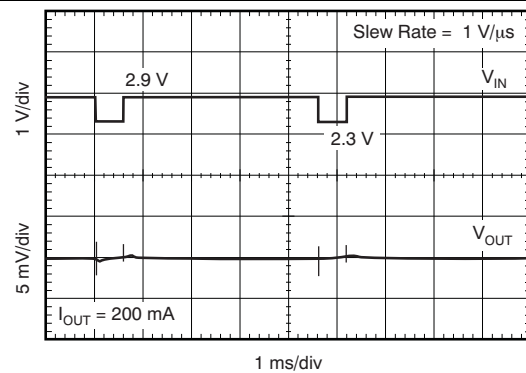

Figure 18. TLV700xx-Q18 Line Transient Response

Typical Characteristics (continued)

$T_J = -40^\circ\text{C}$ to 125°C , $V_{IN} = V_{OUT(TYP)} + 0.5\text{ V}$ or 2 V (whichever is greater); $I_{OUT} = 10\text{ mA}$, $V_{EN} = V_{IN}$, $C_{OUT} = 1\ \mu\text{F}$ (unless otherwise noted). Typical values are at $T_J = 25^\circ\text{C}$.

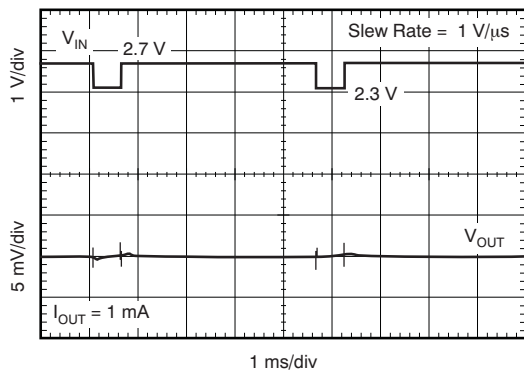

Figure 19. TLV700xx-Q1 Line Transient Response

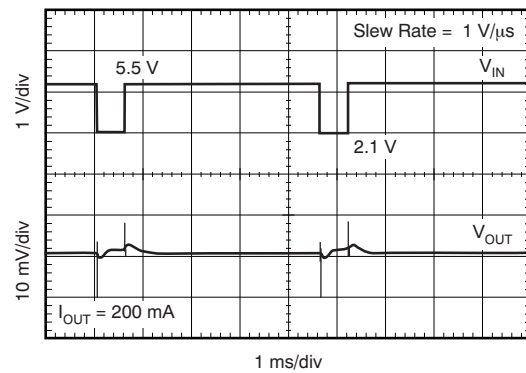

Figure 20. TLV700xx-Q1 Line Transient Response

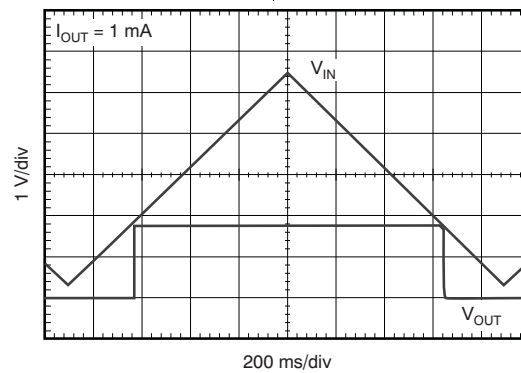

Figure 21. TLV700xx-Q1 V_{IN} Ramp-Up, Ramp-Down Response

7 Detailed Description

7.1 Overview

The TLV700xx-Q1 low-dropout (LDO) linear regulators are low-quiescent-current devices with excellent line- and load-transient performance. These LDOs are designed for power-sensitive applications. A precision band-gap and error amplifier provides overall 2% accuracy together with low output noise, very high power-supply rejection ratio (PSRR), and low dropout voltage.

7.2 Functional Block Diagram

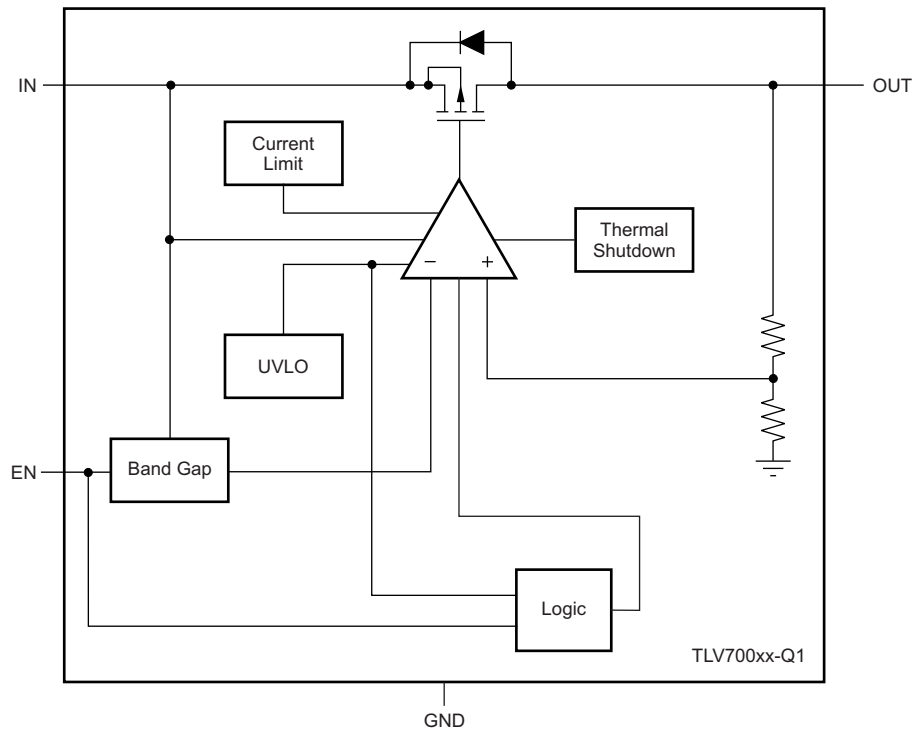

Copyright © 2016, Texas Instruments Incorporated

7.3 Feature Description

7.3.1 Internal Current Limit

The TLV700xx-Q1 internal current limit helps to protect the regulator during fault conditions. During current limit, the output sources a fixed amount of current that is largely independent of the output voltage. In such a case, the output voltage is not regulated, and is $V_{OUT} = I_{LIMIT} \times R_{LOAD}$. The PMOS pass transistor dissipates $(V_{IN} - V_{OUT}) \times I_{LIMIT}$ until thermal shutdown is triggered and the device turns off. As the device cools down, it is turned on by the internal thermal-shutdown circuit. If the fault condition continues, the device cycles between current limit and thermal shutdown. See the [Thermal Information](#) section for more details.

The PMOS pass element in the TLV700xx-Q1 has a built-in body diode that conducts current when the voltage at OUT exceeds the voltage at IN. This current is not limited, so if extended reverse voltage operation is anticipated, external limiting to 5% of the rated output current is recommended.

7.3.2 Shutdown

The enable pin (EN) is active-high and is compatible with standard and low-voltage TTL-CMOS levels. When shutdown capability is not required, EN can be connected to the IN pin.

Feature Description (continued)

7.3.3 Dropout Voltage

The TLV700xx-Q1 uses a PMOS pass transistor to achieve low dropout. When $(V_{IN} - V_{OUT})$ is less than the dropout voltage (V_{DO}), the PMOS pass device is in the linear region of operation and the input-to-output resistance is the $r_{DS(on)}$ of the PMOS pass element. V_{DO} scales approximately with output current because the PMOS device behaves as a resistor in dropout.

As with any linear regulator, PSRR and transient response are degraded as $(V_{IN} - V_{OUT})$ approaches dropout. This effect is shown in [Figure 13](#) in the *Typical Characteristics* section.

7.3.4 Undervoltage Lockout (UVLO)

The TLV700xx-Q1 uses an undervoltage lockout circuit to keep the output shut off until internal circuitry is operating properly.

7.4 Device Functional Modes

7.4.1 Operation With V_{IN} Less than 2 V

The TLV700xx-Q1 family of devices operates with input voltages above 2 V. The typical UVLO voltage is 1.9 V, and the device operates at an input voltage above 2 V. When input voltage falls below the UVLO voltage, the device shuts down.

7.4.2 Operation With V_{IN} Greater than 2 V

When V_{IN} is greater than 2 V, if the input voltage is higher than the desired output voltage plus dropout voltage, the output voltage is equal to the desired value. Otherwise, output voltage is V_{IN} minus the dropout voltage.

8 Application and Implementation

NOTE

Information in the following applications sections is not part of the TI component specification, and TI does not warrant its accuracy or completeness. TI's customers are responsible for determining suitability of components for their purposes. Customers should validate and test their design implementation to confirm system functionality.

8.1 Application Information

The TLV700xx-Q1 belongs to a new family of next-generation value LDO regulators. The device consumes low quiescent current and delivers excellent line and load transient performance. These characteristics, combined with low noise, very good PSRR with little ($V_{IN} - V_{OUT}$) headroom, make this device ideal for RF portable applications. This family of regulators offers subband-gap output voltages down to 0.7 V, current limit, and thermal protection, and is specified from -40°C to 125°C .

8.1.1 Input and Output Capacitor Requirements

Recommended capacitors are 1.0- μF X5R- and X7R-type ceramic because these capacitors have minimal variation in value and equivalent series resistance (ESR) over temperature.

However, the TLV700xx-Q1 is designed to be stable with an *effective capacitance* of 0.1 μF or larger at the output. Thus, the device is stable with capacitors of other dielectric types as well, as long as the effective capacitance under operating bias voltage and temperature is greater than 0.1 μF . This effective capacitance refers to the capacitance that the LDO sees under operating bias voltage and temperature conditions; that is, the capacitance after taking both bias voltage and temperature derating into consideration. In addition to allowing the use of cheaper dielectrics, this capability of being stable with 0.1- μF effective capacitance also enables the use of smaller-footprint capacitors that have higher derating in size- and space-constrained applications.

Note that using a 0.1- μF rated capacitor at the output of the LDO does not ensure stability because the effective capacitance under the specified operating conditions would be less than 0.1 μF . Maximum ESR should be less than 200 m Ω .

Although an input capacitor is not required for stability, it is good analog design practice to connect a 0.1- μF to 1- μF , low-ESR capacitor across the IN pin and GND in of the regulator. This capacitor counteracts reactive input sources and improves transient response, noise rejection, and ripple rejection. A higher-value capacitor may be necessary if large, fast-rise-time load transients are anticipated, or if the device is not located close to the power source. If source impedance is more than 2 Ω , a 0.1- μF input capacitor may be necessary to ensure stability.

High-ESR capacitors may degrade PSRR performance.

8.1.2 Transient Response

As with any regulator, increasing the size of the output capacitor reduces over- and undershoot magnitude but increases the duration of the transient response.

8.1.3 Thermal Information

Thermal protection disables the output when the junction temperature rises to approximately 160°C , allowing the device to cool. When the junction temperature cools to approximately 140°C , the output circuitry is again enabled. Depending on power dissipation, thermal resistance, and ambient temperature, the thermal protection circuit may cycle on and off. This cycling limits the dissipation of the regulator, protecting it from damage as a result of overheating.

Any tendency to activate the thermal protection circuit indicates excessive power dissipation or an inadequate heatsink. For reliable operation, junction temperature should be limited to 125°C maximum. To estimate the margin of safety in a complete design (including heatsink), increase the ambient temperature until the thermal protection is triggered; use worst-case loads and signal conditions. For good reliability, thermal protection should trigger at least 35°C above the maximum expected ambient condition of the particular application. This configuration produces a worst-case junction temperature of 125°C at the highest expected ambient temperature and worst-case load.

Application Information (continued)

The internal protection circuitry of the TLV700xx-Q1 has been designed to protect against overload conditions. It was not intended to replace proper heatsinking. Continuously running the TLV700xx-Q1 into thermal shutdown degrades device reliability.

8.2 Typical Application

The TLV700xx-Q1 devices are 200-mA, low quiescent current, low noise, high PSRR, fast-start-up LDO linear regulators with excellent line and load transient response. The TLV700xxEVM-503 evaluation module (EVM) helps designers evaluate the operation and performance of the TLV700xx-Q1 family.

Figure 22 shows a typical application for the TLV70033-Q1 device.

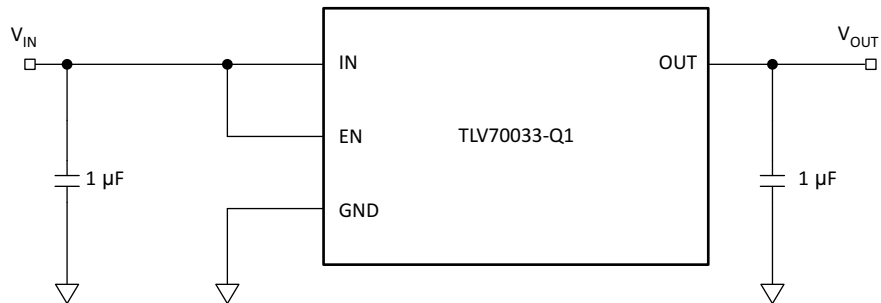

Copyright © 2016, Texas Instruments Incorporated

Figure 22. TLV70033-Q1 Typical Application

8.2.1 Design Requirements

Table 1 shows example design parameters and values for this typical application.

Table 1. Design Parameters

| PARAMETER | VALUE |
|------------------------------------|--------------------------|
| Input voltage range | 2 V to 5.5 V |
| Output voltage | 1.2 V, 2.5 V, 3 V, 3.3 V |
| Output current rating | 200 mA |
| Effective output capacitor range | >0.1 µF |
| Maximum output capacitor ESR range | <200 mΩ |

8.2.2 Detailed Design Procedure

8.2.2.1 Input Capacitance

Although not required for stability, connecting a 0.1-µF to 1-µF low-ESR capacitor across the IN pin and GND in the regulator is good analog design practice.

8.2.2.2 Output Capacitance

Effect capacitance of 0.1 µF or larger is required to ensure stable operation. The maximum ESR must be less than 200 mΩ.

8.2.2.3 Thermal Calculation

See Equation 1 for thermal calculation.

$$P_D = I_{OUT} \times (V_{IN} - V_{OUT}) + I_Q \times V_{IN} \quad (1)$$

where:

- P_D = continuous power dissipation

- I_{OUT} = output current
- V_{IN} = input voltage
- V_{OUT} = output voltage
- Because $I_Q \ll I_{OUT}$, the term $I_Q \times V_{IN}$ is always ignored.

For a device under operation at a given ambient air temperature (T_A), use Equation 2 to calculate the junction temperature (T_J).

$$T_J = T_A + (R_{\theta JA} \times P_D) \quad (2)$$

where:

- $R_{\theta JA}$ = junction-to-ambient air thermal impedance

Use Equation 3 to calculate the rise in junction temperature because of power dissipation.

$$\Delta T = T_J - T_A = (R_{\theta JA} \times P_D) \quad (3)$$

For a given maximum junction temperature (T_{Jmax}), use Equation 4 to calculate the maximum ambient air temperature (T_{Amax}) at which the device can operate.

$$T_{Amax} = T_{Jmax} - (R_{\theta JA} \times P_D) \quad (4)$$

8.2.3 Application Curve

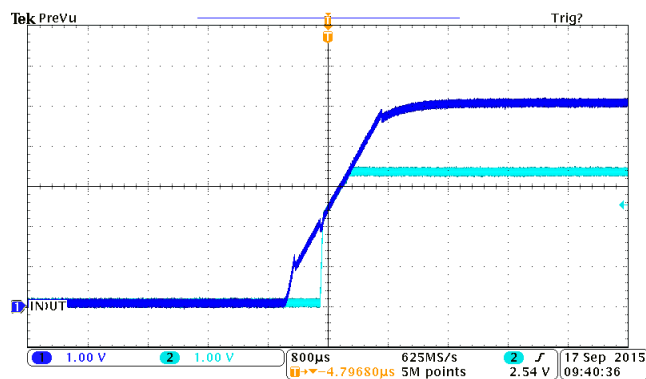

Figure 23. Power Up

9 Power Supply Recommendations

The device is designed to operate from an input-voltage supply range between 2 V and 5.5 V. This input supply must be well regulated. If the input supply is located more than a few inches from the TPS7B69xx-Q1 device, TI recommends adding a capacitor with a value of 0.1 μ F and a ceramic bypass capacitor at the input.

10 Layout

10.1 Layout Guidelines

When laying out the board for the TLV700xx-Q1, TI recommends that the board be designed with separate ground planes for V_{IN} and V_{OUT} which are only connected at the GND pin of the device. Input and output capacitors should be placed as close to the device pins as possible. Also, the ground connection for the bypass capacitor must be connected directly to the GND pin of the device. Improve the PSRR output noise, and transient-response performance of the TLV700xx-Q1 by following these layout guidelines.

10.2 Layout Example

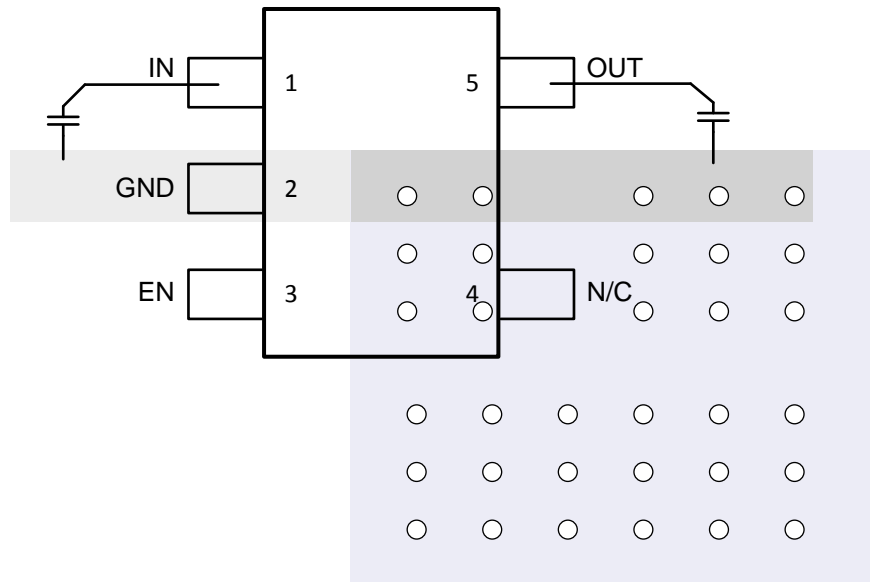

Figure 24. TLV700xx-Q1 Layout Example

11 Device and Documentation Support

11.1 Related Links

The table below lists quick access links. Categories include technical documents, support and community resources, tools and software, and quick access to sample or buy.

Table 2. Related Links

| PARTS | PRODUCT FOLDER | SAMPLE & BUY | TECHNICAL DOCUMENTS | TOOLS & SOFTWARE | SUPPORT & COMMUNITY |
|--------------|----------------------------|----------------------------|----------------------------|----------------------------|----------------------------|
| TLV70012A-Q1 | Click here | Click here | Click here | Click here | Click here |
| TLV70025-Q1 | Click here | Click here | Click here | Click here | Click here |
| TLV70030-Q1 | Click here | Click here | Click here | Click here | Click here |
| TLV70033-Q1 | Click here | Click here | Click here | Click here | Click here |

11.2 Receiving Notification of Documentation Updates

To receive notification of documentation updates, navigate to the device product folder on ti.com. In the upper right corner, click on *Alert me* to register and receive a weekly digest of any product information that has changed. For change details, review the revision history included in any revised document.

11.3 Community Resources

The following links connect to TI community resources. Linked contents are provided "AS IS" by the respective contributors. They do not constitute TI specifications and do not necessarily reflect TI's views; see TI's [Terms of Use](#).

TI E2E™ Online Community *TI's Engineer-to-Engineer (E2E) Community*. Created to foster collaboration among engineers. At e2e.ti.com, you can ask questions, share knowledge, explore ideas and help solve problems with fellow engineers.

Design Support *TI's Design Support* Quickly find helpful E2E forums along with design support tools and contact information for technical support.

11.4 Trademarks

E2E is a trademark of Texas Instruments.
 All other trademarks are the property of their respective owners.

11.5 Electrostatic Discharge Caution



These devices have limited built-in ESD protection. The leads should be shorted together or the device placed in conductive foam during storage or handling to prevent electrostatic damage to the MOS gates.

11.6 Glossary

[SLYZ022](#) — *TI Glossary*.

This glossary lists and explains terms, acronyms, and definitions.

12 Mechanical, Packaging, and Orderable Information

The following pages include mechanical, packaging, and orderable information. This information is the most-current data available for the designated devices. This data is subject to change without notice and without revision of this document. For browser-based versions of this data sheet, see the left-hand navigation pane.

PACKAGING INFORMATION

| Orderable Device | Status (1) | Package Type | Package Drawing | Pins | Package Qty | Eco Plan (2) | Lead finish/ Ball material (6) | MSL Peak Temp (3) | Op Temp (°C) | Device Marking (4/5) | Samples |
|------------------|---------------|--------------|-----------------|------|-------------|-----------------|--------------------------------------|----------------------|--------------|-------------------------|-------------------------|
| TLV70012QDCKRQ1 | ACTIVE | SC70 | DCK | 5 | 3000 | RoHS & Green | NIPDAU | Level-1-260C-UNLIM | -40 to 125 | SDX | Samples |
| TLV70030QDCKRQ1 | ACTIVE | SC70 | DCK | 5 | 3000 | RoHS & Green | NIPDAU | Level-1-260C-UNLIM | -40 to 125 | SDW | Samples |

(1) The marketing status values are defined as follows:

ACTIVE: Product device recommended for new designs.

LIFEBUY: TI has announced that the device will be discontinued, and a lifetime-buy period is in effect.

NRND: Not recommended for new designs. Device is in production to support existing customers, but TI does not recommend using this part in a new design.

PREVIEW: Device has been announced but is not in production. Samples may or may not be available.

OBSOLETE: TI has discontinued the production of the device.

(2) **RoHS:** TI defines "RoHS" to mean semiconductor products that are compliant with the current EU RoHS requirements for all 10 RoHS substances, including the requirement that RoHS substance do not exceed 0.1% by weight in homogeneous materials. Where designed to be soldered at high temperatures, "RoHS" products are suitable for use in specified lead-free processes. TI may reference these types of products as "Pb-Free".

RoHS Exempt: TI defines "RoHS Exempt" to mean products that contain lead but are compliant with EU RoHS pursuant to a specific EU RoHS exemption.

Green: TI defines "Green" to mean the content of Chlorine (Cl) and Bromine (Br) based flame retardants meet JS709B low halogen requirements of <=1000ppm threshold. Antimony trioxide based flame retardants must also meet the <=1000ppm threshold requirement.

(3) MSL, Peak Temp. - The Moisture Sensitivity Level rating according to the JEDEC industry standard classifications, and peak solder temperature.

(4) There may be additional marking, which relates to the logo, the lot trace code information, or the environmental category on the device.

(5) Multiple Device Markings will be inside parentheses. Only one Device Marking contained in parentheses and separated by a "~" will appear on a device. If a line is indented then it is a continuation of the previous line and the two combined represent the entire Device Marking for that device.

(6) Lead finish/Ball material - Orderable Devices may have multiple material finish options. Finish options are separated by a vertical ruled line. Lead finish/Ball material values may wrap to two lines if the finish value exceeds the maximum column width.

Important Information and Disclaimer:The information provided on this page represents TI's knowledge and belief as of the date that it is provided. TI bases its knowledge and belief on information provided by third parties, and makes no representation or warranty as to the accuracy of such information. Efforts are underway to better integrate information from third parties. TI has taken and continues to take reasonable steps to provide representative and accurate information but may not have conducted destructive testing or chemical analysis on incoming materials and chemicals. TI and TI suppliers consider certain information to be proprietary, and thus CAS numbers and other limited information may not be available for release.

In no event shall TI's liability arising out of such information exceed the total purchase price of the TI part(s) at issue in this document sold by TI to Customer on an annual basis.

OTHER QUALIFIED VERSIONS OF TLV700-Q1 :

- Catalog: [TLV700](#)

NOTE: Qualified Version Definitions:

- Catalog - TI's standard catalog product

TAPE AND REEL INFORMATION



QUADRANT ASSIGNMENTS FOR PIN 1 ORIENTATION IN TAPE



*All dimensions are nominal

| Device | Package Type | Package Drawing | Pins | SPQ | Reel Diameter (mm) | Reel Width W1 (mm) | A0 (mm) | B0 (mm) | K0 (mm) | P1 (mm) | W (mm) | Pin1 Quadrant |
|-----------------|--------------|-----------------|------|------|--------------------|--------------------|---------|---------|---------|---------|--------|---------------|
| TLV70012QDCKRQ1 | SC70 | DCK | 5 | 3000 | 178.0 | 9.0 | 2.4 | 2.5 | 1.2 | 4.0 | 8.0 | Q3 |

TAPE AND REEL BOX DIMENSIONS

*All dimensions are nominal

| Device | Package Type | Package Drawing | Pins | SPQ | Length (mm) | Width (mm) | Height (mm) |
|-----------------|--------------|-----------------|------|------|-------------|------------|-------------|
| TLV70012QDCKRQ1 | SC70 | DCK | 5 | 3000 | 180.0 | 180.0 | 18.0 |

DCK0005A



PACKAGE OUTLINE

SOT - 1.1 max height

SMALL OUTLINE TRANSISTOR

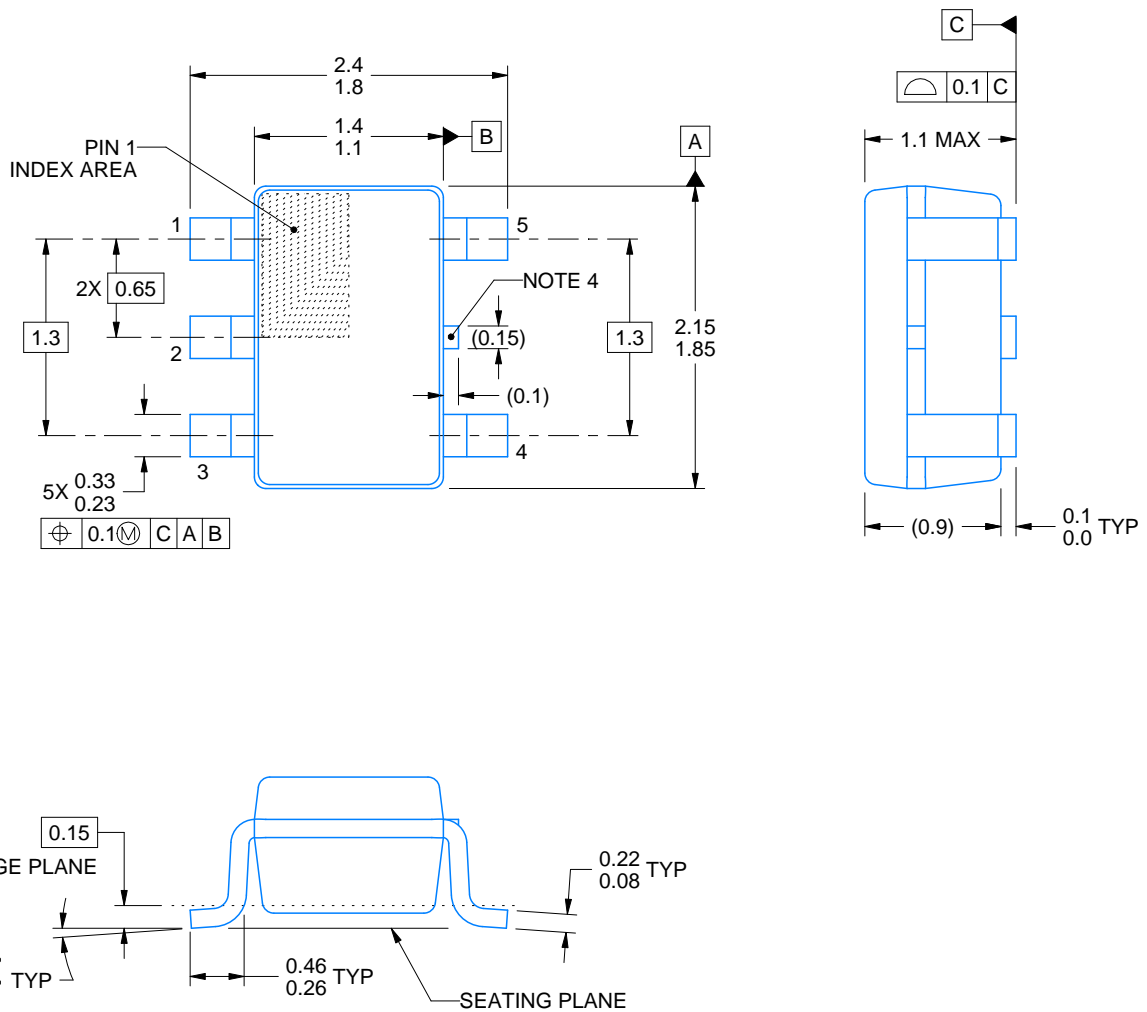

4214834/C 03/2023

NOTES:

1. All linear dimensions are in millimeters. Any dimensions in parenthesis are for reference only. Dimensioning and tolerancing per ASME Y14.5M.
2. This drawing is subject to change without notice.
3. Reference JEDEC MO-203.
4. Support pin may differ or may not be present.

EXAMPLE BOARD LAYOUT

DCK0005A

SOT - 1.1 max height

SMALL OUTLINE TRANSISTOR

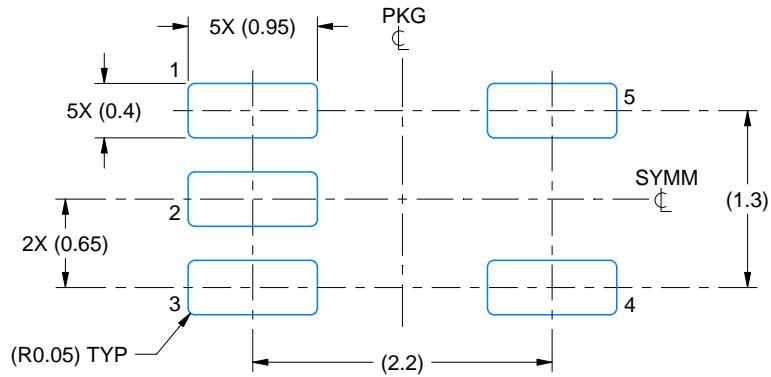

LAND PATTERN EXAMPLE
EXPOSED METAL SHOWN
SCALE:18X



SOLDER MASK DETAILS

4214834/C 03/2023

NOTES: (continued)

4. Publication IPC-7351 may have alternate designs.
5. Solder mask tolerances between and around signal pads can vary based on board fabrication site.

EXAMPLE STENCIL DESIGN

DCK0005A

SOT - 1.1 max height

SMALL OUTLINE TRANSISTOR



SOLDER PASTE EXAMPLE
BASED ON 0.125 THICK STENCIL
SCALE:18X

4214834/C 03/2023

NOTES: (continued)

6. Laser cutting apertures with trapezoidal walls and rounded corners may offer better paste release. IPC-7525 may have alternate design recommendations.
7. Board assembly site may have different recommendations for stencil design.

IMPORTANT NOTICE AND DISCLAIMER

TI PROVIDES TECHNICAL AND RELIABILITY DATA (INCLUDING DATA SHEETS), DESIGN RESOURCES (INCLUDING REFERENCE DESIGNS), APPLICATION OR OTHER DESIGN ADVICE, WEB TOOLS, SAFETY INFORMATION, AND OTHER RESOURCES "AS IS" AND WITH ALL FAULTS, AND DISCLAIMS ALL WARRANTIES, EXPRESS AND IMPLIED, INCLUDING WITHOUT LIMITATION ANY IMPLIED WARRANTIES OF MERCHANTABILITY, FITNESS FOR A PARTICULAR PURPOSE OR NON-INFRINGEMENT OF THIRD PARTY INTELLECTUAL PROPERTY RIGHTS.

These resources are intended for skilled developers designing with TI products. You are solely responsible for (1) selecting the appropriate TI products for your application, (2) designing, validating and testing your application, and (3) ensuring your application meets applicable standards, and any other safety, security, regulatory or other requirements.

These resources are subject to change without notice. TI grants you permission to use these resources only for development of an application that uses the TI products described in the resource. Other reproduction and display of these resources is prohibited. No license is granted to any other TI intellectual property right or to any third party intellectual property right. TI disclaims responsibility for, and you will fully indemnify TI and its representatives against, any claims, damages, costs, losses, and liabilities arising out of your use of these resources.

TI's products are provided subject to [TI's Terms of Sale](#) or other applicable terms available either on [ti.com](https://www.ti.com) or provided in conjunction with such TI products. TI's provision of these resources does not expand or otherwise alter TI's applicable warranties or warranty disclaimers for TI products.

TI objects to and rejects any additional or different terms you may have proposed.

Mailing Address: Texas Instruments, Post Office Box 655303, Dallas, Texas 75265
Copyright © 2023, Texas Instruments Incorporated