

TLV760 100mA 30V 固定输出线性电压调整器

1 特性

- 高达 30V 的宽输入电压范围
- 高达 100mA 的输出电流
- 提供固定输出电压 3.3V、5V、12V 和 15V 版本
- 运行结温范围为 -40°C 至 $+125^{\circ}\text{C}$
- 接 $0.1\mu\text{F}$ 及以上的陶瓷电容器保持稳定工作
- 有效的热保护和电流限制

2 应用

- 用于开关直流/直流转换器的后置稳压器
- 用于数字和模拟电路的偏置电源
- 家用电器
- 电动工具
- 工厂和楼宇自动化

3 说明

TLV760 是一款集成的线性电压调整器，能够以高达 30V 的输入电压运行。在运行温度范围内，TLV760 可在 100mA 满负载下具有 1.2V 的最大压降。TLV760 的标准封装是 3 引脚 SOT-23 封装。

TLV760 提供 3.3V、5V、12V 和 15V 版本。TLV760 系列的 SOT-23 封装允许器件用于空间受限的应用。TLV760 是 LM78Lxx 系列和类似器件的小尺寸替代产品。

TLV760 用于对遭受高达 30V 的电源瞬态和尖峰的应用（例如电器和自动化应用）中的数字和模拟电路进行偏置。该器件具有可靠的内部热保护功能，可以保护其自身免受由接地短路、环境温度升高、高负载或高压降事件等情况导致的潜在损害。

器件信息⁽¹⁾

| 器件型号 | 封装 | 封装尺寸 (标称值) |
|--------|------------|-----------------|
| TLV760 | SOT-23 (3) | 2.92mm x 1.30mm |

(1) 如需了解所有可用封装，请参阅产品说明书末尾的可订购产品附录。

典型应用电路

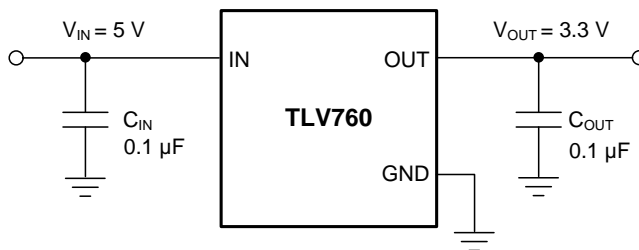

Copyright © 2017, Texas Instruments Incorporated



目录

| | | | | | |
|----------|--|----------|-----------|---|-----------|
| 1 | 特性 | 1 | 7.4 | Device Functional Modes..... | 10 |
| 2 | 应用 | 1 | 8 | Application and Implementation | 11 |
| 3 | 说明 | 1 | 8.1 | Application Information..... | 11 |
| 4 | 修订历史记录 | 2 | 8.2 | Typical Application | 12 |
| 5 | Pin Configuration and Functions | 3 | 9 | Power Supply Recommendations | 14 |
| 6 | Specifications | 4 | 10 | Layout | 14 |
| 6.1 | Absolute Maximum Ratings | 4 | 10.1 | Layout Guidelines | 14 |
| 6.2 | ESD Ratings..... | 4 | 10.2 | Layout Example | 14 |
| 6.3 | Recommended Operating Conditions..... | 4 | 11 | 器件和文档支持 | 15 |
| 6.4 | Thermal Information | 4 | 11.1 | 器件支持 | 15 |
| 6.5 | Electrical Characteristics..... | 5 | 11.2 | 接收文档更新通知 | 15 |
| 6.6 | Typical Characteristics | 6 | 11.3 | 社区资源..... | 15 |
| 7 | Detailed Description | 9 | 11.4 | 商标..... | 15 |
| 7.1 | Overview | 9 | 11.5 | 静电放电警告..... | 15 |
| 7.2 | Functional Block Diagram | 9 | 11.6 | Glossary | 15 |
| 7.3 | Feature Description..... | 9 | 12 | 机械、封装和可订购信息..... | 15 |

4 修订历史记录

注：之前版本的页码可能与当前版本有所不同。

Changes from Original (June 2017) to Revision A

Page

| | | |
|---|--|----------|
| • | Changed description of pin 1 to "OUT" and pin 2 to "IN" to correct error | 3 |
|---|--|----------|

5 Pin Configuration and Functions

**DBZ Package
3-Pin SOT-23
Top View**

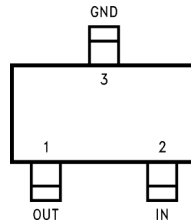

Pin Functions

| PIN | | I/O | DESCRIPTION |
|-----|------|-----|--|
| NO. | NAME | | |
| 1 | OUT | O | Output voltage, a ceramic capacitor greater than or equal to 0.1 μ F is need for the stability of the device. ⁽¹⁾ |
| 2 | IN | I | Input voltage supply — TI recommends a capacitor of value greater than 0.1 μ F at the input. ⁽¹⁾ |
| 3 | GND | — | Common ground |

(1) See [External Capacitors](#) for more details.

6 Specifications

6.1 Absolute Maximum Ratings⁽¹⁾

| | MIN | MAX | UNIT |
|--------------------------------|------|-----------------------------------|------|
| Input voltage (IN to GND) | –0.3 | 35 | V |
| Output Voltage (OUT) | | $V_{IN} + 0.3$ | V |
| Output Current | | Internally limited ⁽²⁾ | mA |
| Junction temperature | –40 | 150 | °C |
| Storage temperature, T_{stg} | –65 | 150 | °C |

- (1) Stresses beyond those listed under *Absolute Maximum Ratings*⁽¹⁾ may cause permanent damage to the device. These are stress ratings only, which do not imply functional operation of the device at these or any other conditions beyond those indicated under *Recommended Operating Conditions*. Exposure to absolute-maximum-rated conditions for extended periods may affect device reliability.
- (2) See *Recommended Operating Conditions* section for more details.

6.2 ESD Ratings

| | | VALUE | UNIT |
|-------------|-------------------------|--|-------|
| $V_{(ESD)}$ | Electrostatic discharge | Human-body model (HBM), per ANSI/ESDA/JEDEC JS-001 ⁽¹⁾ | ±2000 |
| | | Charged-device model (CDM), per JEDEC specification JESD22-C101 ⁽²⁾ | ±500 |
| | | | V |

- (1) JEDEC document JEP155 states that 500-V HBM allows safe manufacturing with a standard ESD control process.
- (2) JEDEC document JEP157 states that 250-V CDM allows safe manufacturing with a standard ESD control process.

6.3 Recommended Operating Conditions

over operating free-air temperature range (unless otherwise noted)

| | MIN | MAX | UNIT |
|--|-----|-----|------|
| Maximum input voltage (IN to GND) | | 30 | V |
| Output current (I_{OUT}) | | 100 | mA |
| Input and output capacitor (C_{OUT}) | 0.1 | | μF |
| Junction temperature, T_J | –40 | 125 | °C |

6.4 Thermal Information

| THERMAL METRIC ⁽¹⁾ | | TLV760 | UNIT |
|-------------------------------|--|--------------|------|
| | | DBZ (SOT-23) | |
| | | 3 PINS | |
| $R_{\theta JA}$ | Junction-to-ambient thermal resistance | 275.2 | °C/W |
| $R_{\theta JC(top)}$ | Junction-to-case (top) thermal resistance | 92.8 | °C/W |
| $R_{\theta JB}$ | Junction-to-board thermal resistance | 56.8 | °C/W |
| Ψ_{JT} | Junction-to-top characterization parameter | 2.9 | °C/W |
| Ψ_{JB} | Junction-to-board characterization parameter | 55.6 | °C/W |

- (1) For more information about traditional and new thermal metrics, see the *Semiconductor and IC Package Thermal Metrics* application report.

6.5 Electrical Characteristics

Typical and other limits apply for $T_A = T_J = 25^\circ\text{C}$, $V_{\text{OUT(NOM)}} = 3.3\text{ V}, 5\text{ V}, 12\text{ V}, \text{ and } 15\text{ V}$, unless otherwise specified.

| PARAMETER | | TEST CONDITIONS | | MIN | TYP | MAX | UNIT |
|--------------------------------------|------------------------------|--|--|-----|-----|-----|------------------|
| V_{OUT} | Output voltage accuracy | $V_{\text{IN}} = V_{\text{OUT(NOM)}} + 1.5\text{ V}$, $1\text{ mA} \leq I_{\text{OUT}} \leq 100\text{ mA}$ | | -4% | | 4% | V |
| | | $V_{\text{IN}} = V_{\text{OUT(NOM)}} + 1.5\text{ V}$, $1\text{ mA} \leq I_{\text{OUT}} \leq 100\text{ mA}$, $-40^\circ\text{C} \leq T_J \leq 125^\circ\text{C}$ | | -5% | | 5% | |
| $\Delta V_{(\Delta V_{\text{IN}})}$ | Line regulation | $V_{\text{OUT(NOM)}} + 1.5\text{ V} \leq V_{\text{IN}} \leq 30\text{ V}$ $I_{\text{OUT}} = 1\text{ mA}$, $-40^\circ\text{C} \leq T_J \leq 125^\circ\text{C}$ | $V_{\text{OUT(NOM)}} = 3.3\text{ V}, 5\text{ V}$ | | 10 | 30 | mV |
| | | | $V_{\text{OUT(NOM)}} = 12\text{ V}, 15\text{ V}$ | | 14 | 45 | |
| $\Delta V_{(\Delta I_{\text{OUT}})}$ | Load regulation | $V_{\text{IN}} = V_{\text{OUT(NOM)}} + 1.5\text{ V}$, $10\text{ mA} \leq I_{\text{OUT}} \leq 100\text{ mA}$, $-40^\circ\text{C} \leq T_J \leq 125^\circ\text{C}$ | $V_{\text{OUT(NOM)}} = 3.3\text{ V}, 5\text{ V}$ | | 20 | 45 | mV |
| | | | $V_{\text{OUT(NOM)}} = 12\text{ V}, 15\text{ V}$ | | 45 | 80 | |
| I_{GND} | Ground pin current | $V_{\text{OUT(NOM)}} + 1.5\text{ V} \leq V_{\text{IN}} \leq 30\text{ V}$, no load, $-40^\circ\text{C} \leq T_J \leq 125^\circ\text{C}$ | | | 2 | 5 | mA |
| V_{DO} | Dropout voltage | $I_{\text{OUT}} = 10\text{ mA}$ | | | 0.7 | 0.9 | V |
| | | $I_{\text{OUT}} = 10\text{ mA}$, $-40^\circ\text{C} \leq T_J \leq 125^\circ\text{C}$ | | | | 1 | |
| | | $I_{\text{OUT}} = 100\text{ mA}$ | | | 0.9 | 1.1 | |
| | | $I_{\text{OUT}} = 100\text{ mA}$, $-40^\circ\text{C} \leq T_J \leq 125^\circ\text{C}$ | | | | 1.2 | |
| T_{SD} | Thermal shutdown temperature | | | | 150 | | $^\circ\text{C}$ |

6.6 Typical Characteristics

Unless indicated otherwise, $V_{IN} = V_{NOM} + 1.5\text{ V}$, $C_{IN} = 0.1\ \mu\text{F}$, $C_{OUT} = 0.1\ \mu\text{F}$, and $T_A = 25^\circ\text{C}$.

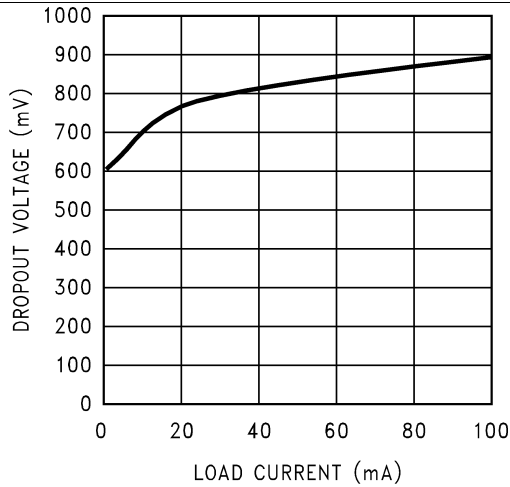

Figure 1. Dropout Voltage vs Load Current

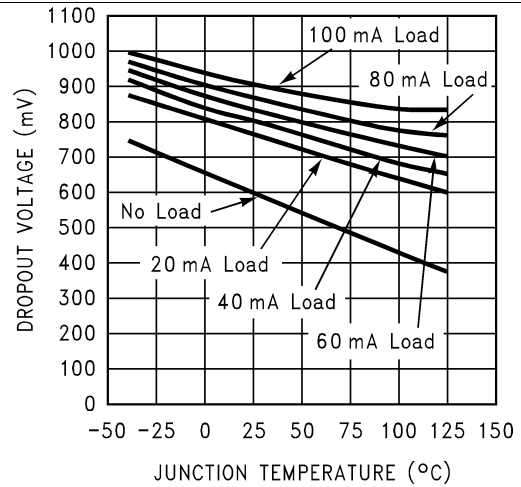

Figure 2. Dropout Voltage vs Junction Temperature

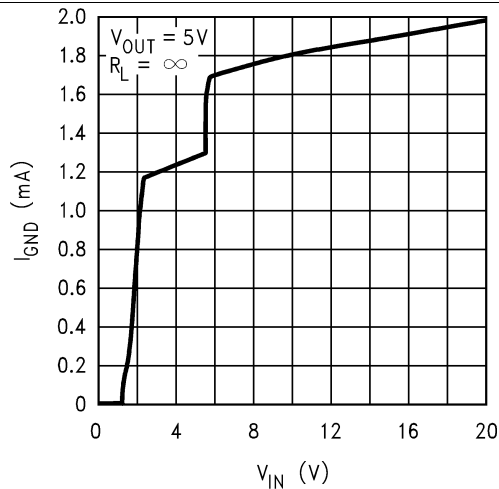

Figure 3. Ground Pin Current vs Input Voltage

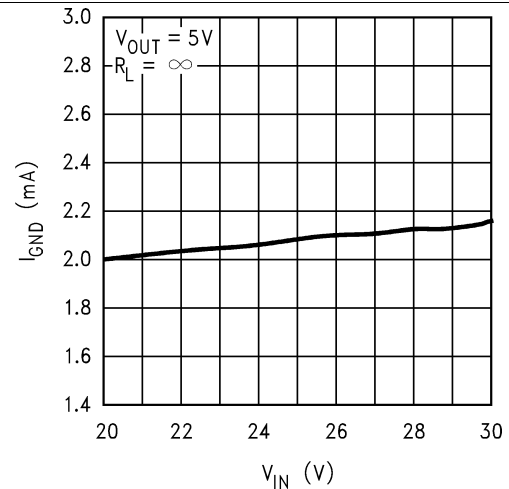

Figure 4. Ground Pin Current vs Input Voltage

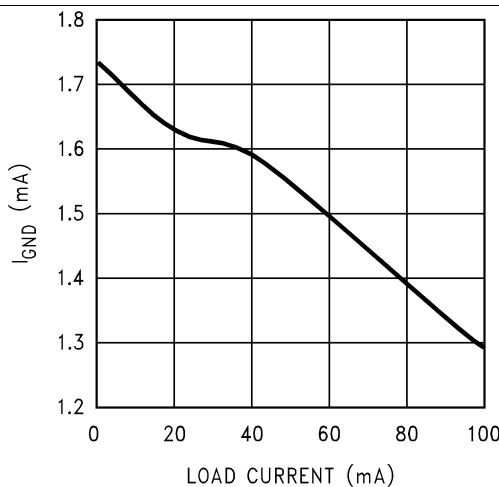

Figure 5. Ground Pin Current vs Load Current

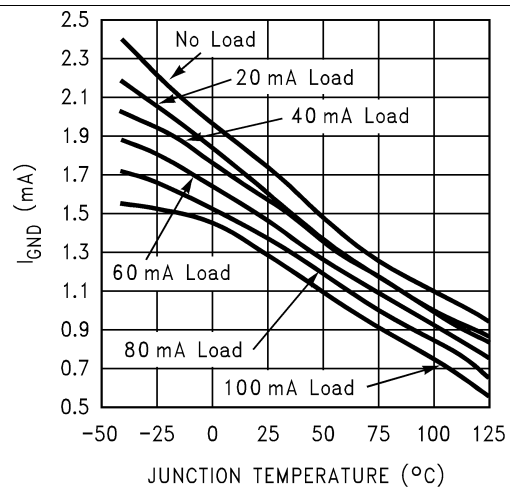

Figure 6. Ground Pin Current vs Junction Temperature

Typical Characteristics (continued)

Unless indicated otherwise, $V_{IN} = V_{NOM} + 1.5\text{ V}$, $C_{IN} = 0.1\ \mu\text{F}$, $C_{OUT} = 0.1\ \mu\text{F}$, and $T_A = 25^\circ\text{C}$.

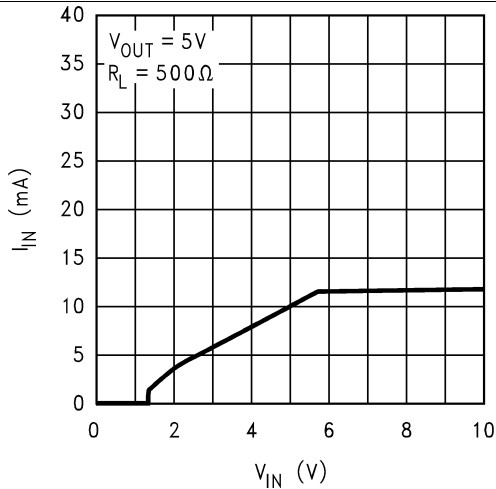

Figure 7. Input Current vs Input Voltage

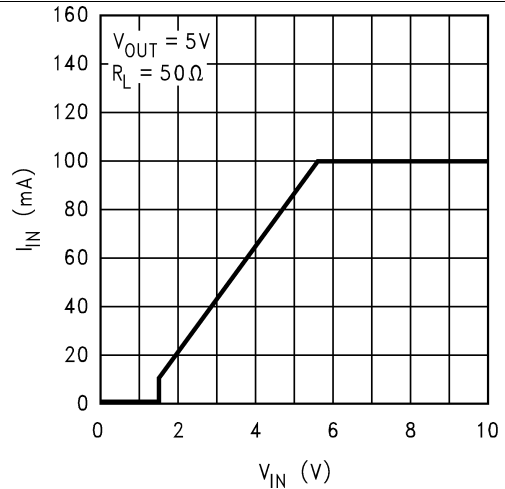

Figure 8. Input Current vs Input Voltage

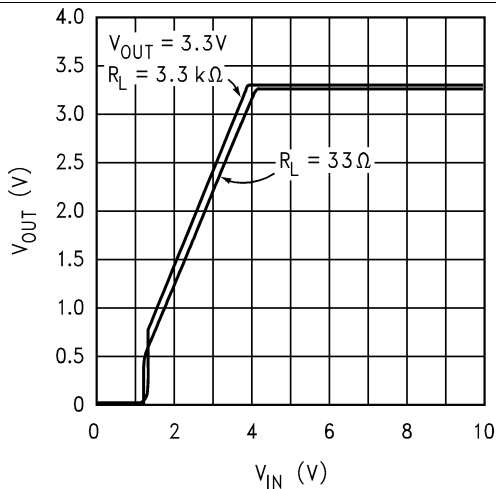

Figure 9. Output Voltage vs Input Voltage

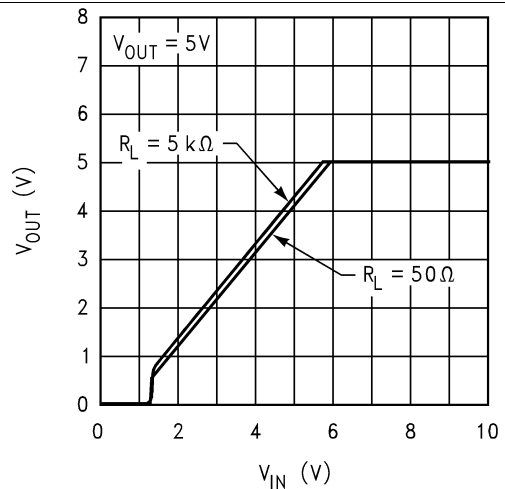

Figure 10. Output Voltage vs Input Voltage

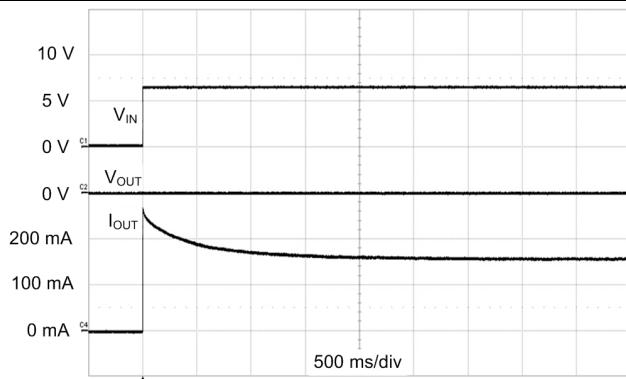

Figure 11. Output Short-Circuit Current

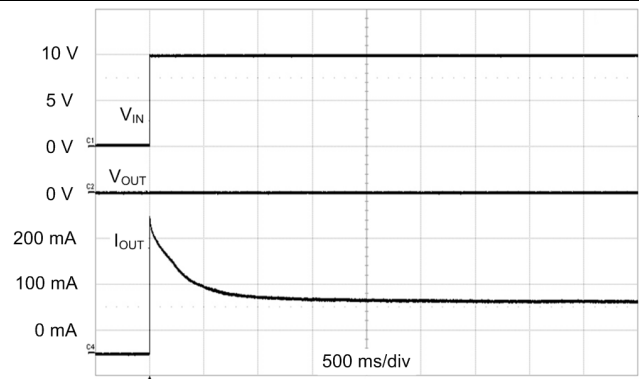

Figure 12. Output Short-Circuit Current

Typical Characteristics (continued)

Unless indicated otherwise, $V_{IN} = V_{NOM} + 1.5\text{ V}$, $C_{IN} = 0.1\ \mu\text{F}$, $C_{OUT} = 0.1\ \mu\text{F}$, and $T_A = 25^\circ\text{C}$.

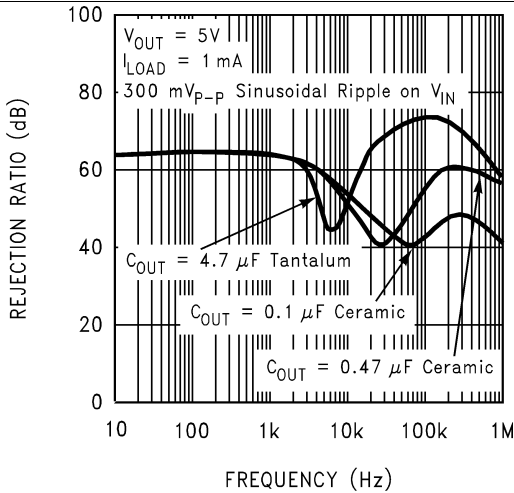

Figure 13. Power Supply Rejection Ratio

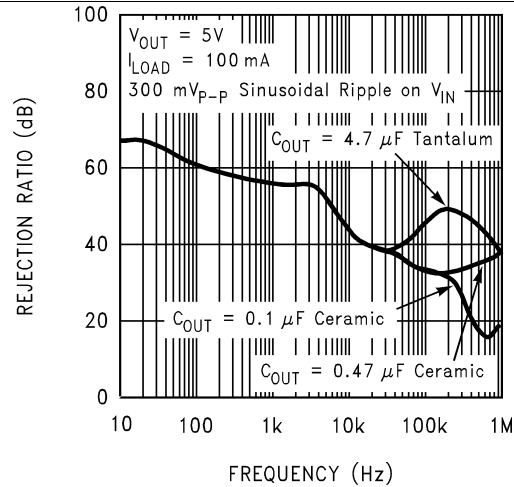

Figure 14. Power Supply Rejection Ratio

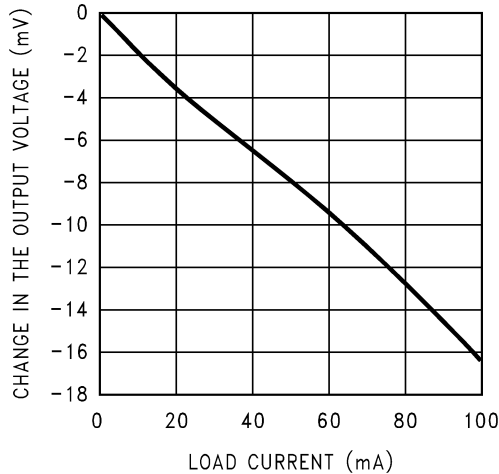

Figure 15. DC Load Regulation

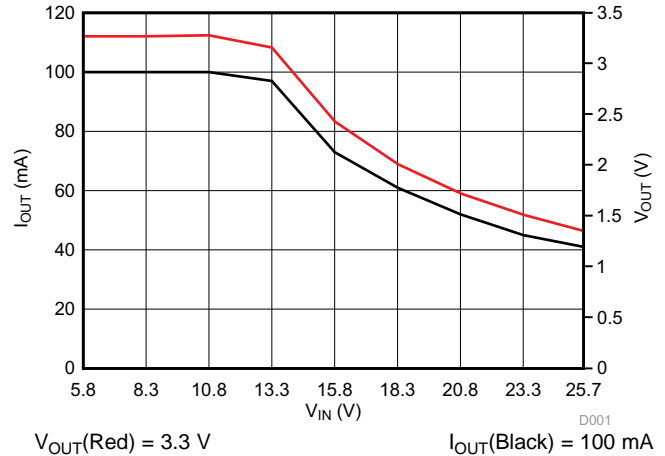

Figure 16. Output Current vs Input Voltage

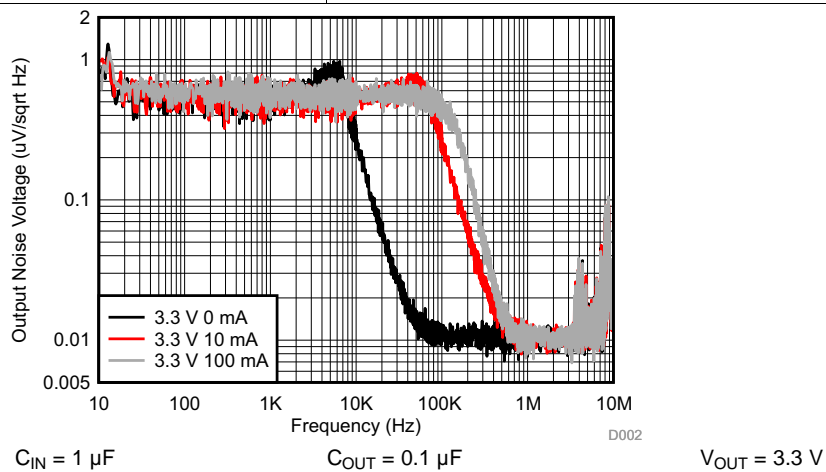

Figure 17. Output Spectral Noise Density vs Frequency

7 Detailed Description

7.1 Overview

The TLV760 is an integrated linear-voltage regulator with inputs that can be as high as 30 V. The TLV760 features [quasi LDO architecture](#), which allows the usage of low ESR capacitors at the output. A ceramic capacitor with a capacitance value greater than or equal to 0.1 μF is adequate to keep the linear regulator in stable operation. The device has a rugged active junction thermal protection mechanism.

7.2 Functional Block Diagram

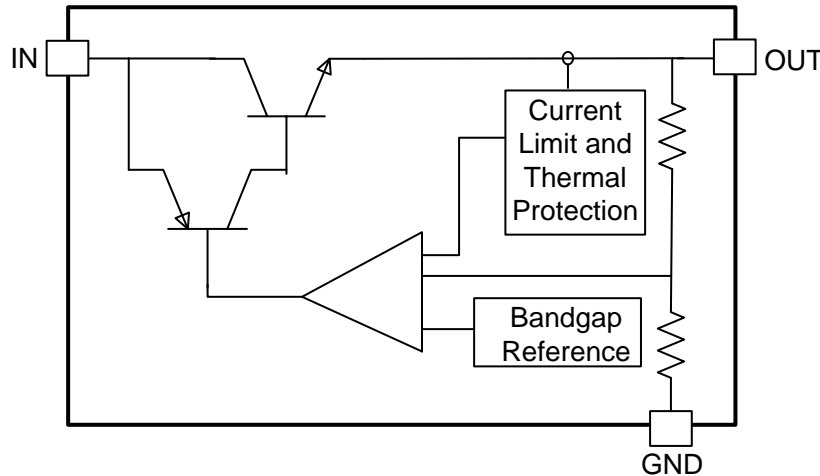

Copyright © 2017, Texas Instruments Incorporated

7.3 Feature Description

7.3.1 Thermal Protection

The TLV760 contains an active thermal protection mechanism, which limits the junction temperature to 150°C. This protection comes into action when the thermal junction temperature of the device tries to exceed 150°C. The output current of the device is limited or folded back to maintain the junction temperature.

The thermal protection follows [Equation 1](#)

$$P_D = (T_J - T_A) / R_{\theta JA}$$

where

- $P_D = (V_{IN} - V_{OUT}) I_{OUT}$
 - T_J is the junction temperature
 - $R_{\theta JA}$ is the junction-to-ambient thermal resistance
- (1)

When a high drop out condition occurs resulting in higher power dissipation across the device the output current is limited to maintain a constant junction temperature of 150°C. This rugged feature protects the device from higher power dissipation applications as well as the short to ground at the output.

This internal protection circuitry of TLV760 is intended to protect the devices against thermal overload conditions. The circuitry is not intended to replace proper heat sinking. Continuously running the TLV760 into thermal protection degrades device reliability.

For reliable operation, limit junction temperature to a maximum of 125°C. To estimate the thermal margin in a given layout, increase the ambient temperature until the thermal protection is triggered using worst case load and highest input voltage conditions.

Feature Description (continued)

7.3.2 Dropout Voltage

The TLV760 is a bipolar device with [quasi LDO architecture](#). Being a bipolar device the dropout voltage of the device does not change significantly with output load current. The device has a maximum dropout across temperature of 1.2 V at 100-mA load current, which is a significant improvement over the traditional LM78Lxx devices.

7.4 Device Functional Modes

7.4.1 Normal Operation

The TLV760 operates with an input up to 30 V. Its tiny SOT-23 package and quasi-LDO architecture makes it suitable for providing a very tiny 100-mA bias supply. The device regulates to the nominal output voltage when all of the following conditions are met.

- The input voltage is greater than the nominal output voltage plus the dropout voltage ($V_{OUT(NOM)} + V_{DO}$).
- The output current is less than or equal to 100 mA.
- The device junction temperature is less than the thermal protection temperature of 150°C.

8 Application and Implementation

NOTE

Information in the following applications sections is not part of the TI component specification, and TI does not warrant its accuracy or completeness. TI's customers are responsible for determining suitability of components for their purposes. Customers should validate and test their design implementation to confirm system functionality.

8.1 Application Information

The TLV760 is a fixed output device which need only input and output capacitors to function. This section discusses the key aspects to implement this linear regulator in typical applications.

8.1.1 Fixed Output

TLV760 comes in fixed output voltage options, 3.3 V, 5 V, 12 V and 15 V. To ensure the proper regulated output, the input voltage should be greater than $V_{OUT(nom)} + V_{DO}$.

8.1.2 External Capacitors

8.1.2.1 Input and Output Capacitor Requirements

A minimum input and output capacitance value of 0.1 μ F is required for stability and adequate transient performance. There is no specific equivalent series resistance (ESR) limitation, although excessively high ESR compromises transient performance. There is no specific limitation on a maximum capacitance value on the input or the output. However while selecting a capacitor, derating factors on the capacitance value should be considered. Use C0G, X7R, or X5R-type ceramic capacitors because these capacitors have minimal variation in capacitance value and ESR over temperature.

8.1.2.2 Load-Step Transient Response

The load-step transient response is the output voltage response by the linear regulator to a step change in load current. The depth of charge depletion immediately after the load step is directly proportional to the amount of output capacitance. However, larger output capacitances decrease any voltage dip or peak occurring during a load step, the control-loop bandwidth is also decreased, thereby slowing the response time. TI recommends to optimally scale output capacitors for a specific application and test for the output load transients.

8.1.3 Power Dissipation

Proper consideration should be given to device power dissipation, location of the circuit on the printed circuit board (PCB), and correct sizing of the thermal plane to ensure the device reliability. The PCB area around the regulator must be as free as possible of other heat-generating devices that cause added thermal stresses. To first-order approximation, power dissipation in the regulator depends on the input-to-output voltage difference and load conditions. Power dissipation can be calculated using The thermal protection follows [Equation 1](#):

$$P_D = (T_J - T_A) / R_{\theta JA}$$

where

- $P_D = (V_{IN} - V_{OUT}) I_{OUT}$
 - T_J is the junction temperature
 - $R_{\theta JA}$ is the junction-to-ambient thermal resistance
- (2)

Thus, at a given load current, input and output voltage, maximum power dissipation determines the maximum allowable ambient temperature (T_A) for the device, and vice versa. Power dissipation and junction temperature are most often related by the junction-to-ambient thermal resistance ($R_{\theta JA}$) of the combined PCB and device package and the temperature of the ambient air (T_A).

$R_{\theta JA}$ is highly dependent on the heat-spreading capability built into the particular PCB design, and therefore varies according to the total copper area, copper weight, and location of the planes. The $R_{\theta JA}$ recorded in [Thermal Information](#) is determined by the JEDEC standard, PCB, and copper-spreading area and is only used as a relative measure of package thermal performance.

Application Information (continued)

TLV760 integrates a rugged protection where the T_J is limited to 150°C. The maximum power dissipation depends on the ambient temperature and can be calculated using $P_D = (T_J - T_A) / R_{\theta JA}$, for example, substituting the absolute maximum junction temperature, 150°C for T_J , 50°C for T_A , and 275.2 °C/W for $R_{\theta JA}$, the maximum power that can be dissipated is 363 mW. More power can be safely dissipated at lower ambient temperatures. Less power can be safely dissipated at higher ambient temperatures. The power dissipation can be increased by 3.6 mW for each °C below 50°C ambient. It must be derated by 3.6 mW for each °C above 50°C ambient. Proper heat sinking enables the safe dissipation of more power.

8.2 Typical Application

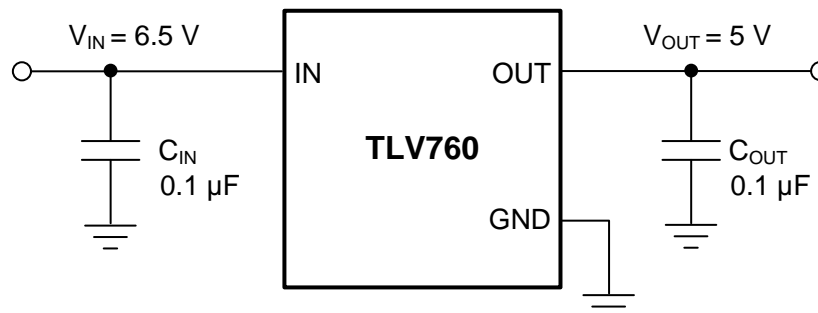

Copyright © 2017, Texas Instruments Incorporated

Figure 18. Typical Application for the 5-V Option

8.2.1 Design Requirements

For typical TLV760 applications, use the parameters in [Table 1](#).

Table 1. Design Parameters

| DESIGN PARAMETER | EXAMPLE VALUE |
|------------------|---------------|
| Input voltage | 6.5 V |
| Output voltage | 5 V |
| Output current | 100 mA |

8.2.2 Detailed Design Procedure

The output for TLV76050 is internally set to 5 V. Input and output capacitors can be selected in accordance with the [External Capacitors](#). Ceramic capacitances of 0.1 µF for both input and output are selected.

See the [Layout](#) section for an example of how to PCB layout the TLV760 to achieve best performance.

8.2.3 Application Curves

Unless indicated otherwise, $V_{IN} = 6.5\text{ V}$, $V_{OUT} = 5\text{ V}$, $C_{OUT} = 0.1\ \mu\text{F}$, and $T_A = 25^\circ\text{C}$.

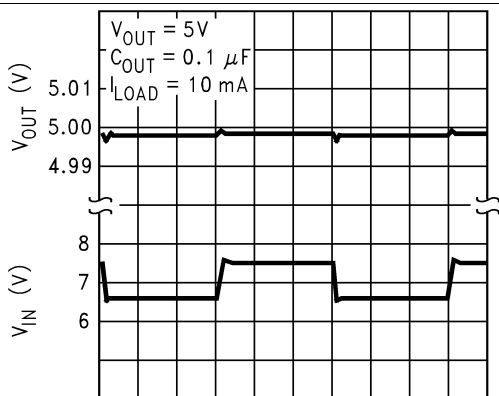

200 $\mu\text{s}/\text{Div}$

Figure 19. Line Transient Response

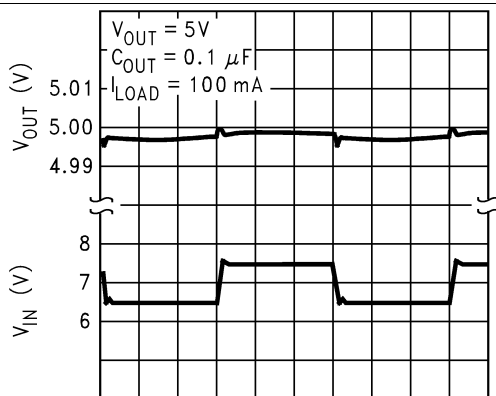

200 $\mu\text{s}/\text{Div}$

Figure 20. Line Transient Response

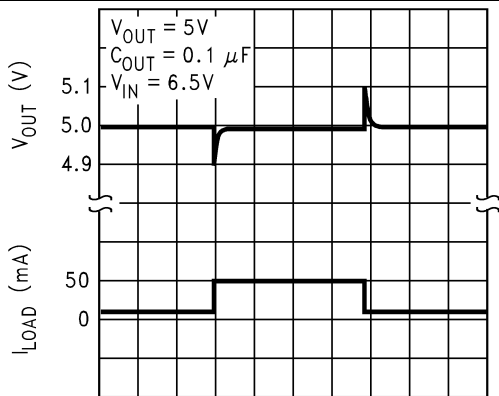

50 $\mu\text{s}/\text{Div}$

Figure 21. Load Transient Response

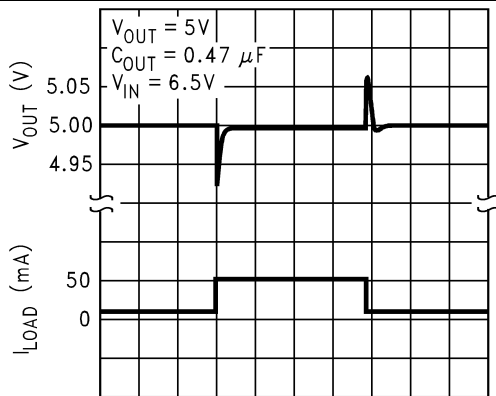

50 $\mu\text{s}/\text{Div}$

Figure 22. Load Transient Response

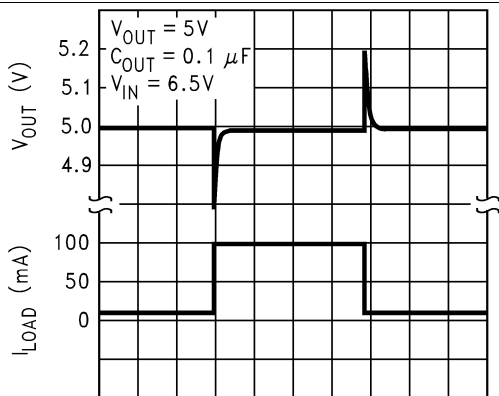

50 $\mu\text{s}/\text{Div}$

Figure 23. Load Transient Response

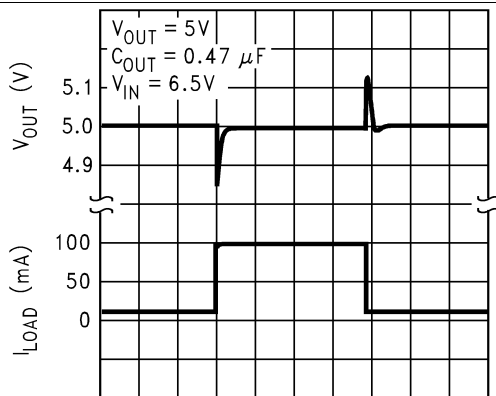

50 $\mu\text{s}/\text{Div}$

Figure 24. Load Transient Response

9 Power Supply Recommendations

The TLV760 is designed to operate from input voltage up to 30 V. If the input power supply has ripples, additional input and output capacitors with low ESR can help improve the PSRR at higher frequencies.

10 Layout

10.1 Layout Guidelines

General guidelines for linear regulator designs are to place all circuit components on the same side of the circuit board and as near as practical to the respective TLV760 pin connections. Place ground return connections to the input and output capacitors, and to the TLV760 ground pin as close as possible to each other, connected by a wide, component-side, copper surface. The use of vias and long traces to create TLV760 circuit connections is strongly discouraged and negatively affects system performance.

Use a ground reference plane, either embedded in the PCB itself or located on the bottom side of the PCB opposite the components. This reference plane serves to assure accuracy of the output voltage and to shield noise; it behaves similarly to a thermal plane to spread heat from the linear regulator. In most applications, this ground plane is necessary to meet thermal requirements.

10.2 Layout Example

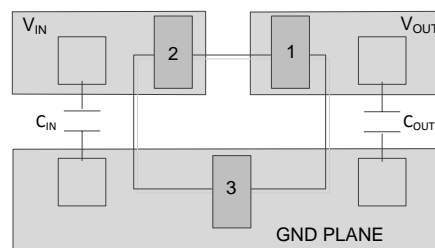

Figure 25. Layout Guideline for TLV760

11 器件和文档支持

11.1 器件支持

11.1.1 相关文档

请参阅如下相关文档：

《[AN-1148 线性稳压器：工作原理和补偿](#)》

11.1.2 Spice 模型

分析模拟电路和系统的性能时，使用 **SPICE** 模型对电路性能进行计算机仿真非常有用。您可以通过 **TLV760** 产品文件夹在仿真模型下获取 **TLV760** 的 **SPICE** 模型。

11.1.3 器件命名规则

表 2. 订购信息⁽¹⁾

| 产品 | 说明 |
|-------------|---|
| TLV760XXYYZ | XX 是电压符号 YYY 是封装符号。 Z 为封装数量。 |

(1) 欲获得最新的封装和订货信息，请参阅本文档末尾的封装选项附录，或者访问 www.ti.com 查看器件产品文件夹。

11.2 接收文档更新通知

要接收文档更新通知，请转至 TI.com 上的器件产品文件夹。单击右上角的 **通知我** 进行注册，即可每周接收产品信息更改摘要。有关更改的详细信息，请查看任何已修订文档中包含的修订历史记录。

11.3 社区资源

下列链接提供到 **TI** 社区资源的连接。链接的内容由各个分销商“按照原样”提供。这些内容并不构成 **TI** 技术规范，并且不一定反映 **TI** 的观点；请参阅 **TI** 的《[使用条款](#)》。

TI E2E™ 在线社区 **TI 的工程师对工程师 (E2E) 社区**。此社区的创建目的在于促进工程师之间的协作。在 e2e.ti.com 中，您可以咨询问题、分享知识、拓展思路并与同行工程师一道帮助解决问题。

设计支持 **TI 参考设计支持** 可帮助您快速查找有帮助的 **E2E** 论坛、设计支持工具以及技术支持的联系信息。

11.4 商标

E2E is a trademark of Texas Instruments.
 All other trademarks are the property of their respective owners.

11.5 静电放电警告



这些装置包含有限的内置 **ESD** 保护。存储或装卸时，应将导线一起截短或将装置放置于导电泡棉中，以防止 **MOS** 门极遭受静电损伤。

11.6 Glossary

[SLYZ022](#) — *TI Glossary*.

This glossary lists and explains terms, acronyms, and definitions.

12 机械、封装和可订购信息

以下页面包含机械、封装和可订购信息。这些信息是指定器件的最新可用数据。这些数据如有变更，恕不另行通知和修订此文档。如欲获取此产品说明书的浏览器版本，请参阅左侧的导航。

PACKAGING INFORMATION

| Orderable Device | Status (1) | Package Type | Package Drawing | Pins | Package Qty | Eco Plan (2) | Lead finish/ Ball material (6) | MSL Peak Temp (3) | Op Temp (°C) | Device Marking (4/5) | Samples |
|------------------|---------------|--------------|-----------------|------|-------------|-----------------|--------------------------------------|----------------------|--------------|-------------------------|-------------------------|
| TLV76012DBZR | ACTIVE | SOT-23 | DBZ | 3 | 3000 | RoHS & Green | SN | Level-1-260C-UNLIM | -40 to 125 | 18G | Samples |
| TLV76012DBZT | ACTIVE | SOT-23 | DBZ | 3 | 250 | RoHS & Green | SN | Level-1-260C-UNLIM | -40 to 125 | 18G | Samples |
| TLV76015DBZR | ACTIVE | SOT-23 | DBZ | 3 | 3000 | RoHS & Green | SN | Level-1-260C-UNLIM | -40 to 125 | 18C | Samples |
| TLV76015DBZT | ACTIVE | SOT-23 | DBZ | 3 | 250 | RoHS & Green | SN | Level-1-260C-UNLIM | -40 to 125 | 18C | Samples |
| TLV76033DBZR | ACTIVE | SOT-23 | DBZ | 3 | 3000 | RoHS & Green | SN | Level-1-260C-UNLIM | -40 to 125 | 18H | Samples |
| TLV76033DBZT | ACTIVE | SOT-23 | DBZ | 3 | 250 | RoHS & Green | SN | Level-1-260C-UNLIM | -40 to 125 | 18H | Samples |
| TLV76050DBZR | ACTIVE | SOT-23 | DBZ | 3 | 3000 | RoHS & Green | SN | Level-1-260C-UNLIM | -40 to 125 | 18I | Samples |
| TLV76050DBZT | ACTIVE | SOT-23 | DBZ | 3 | 250 | RoHS & Green | SN | Level-1-260C-UNLIM | -40 to 125 | 18I | Samples |

(1) The marketing status values are defined as follows:

ACTIVE: Product device recommended for new designs.

LIFEBUY: TI has announced that the device will be discontinued, and a lifetime-buy period is in effect.

NRND: Not recommended for new designs. Device is in production to support existing customers, but TI does not recommend using this part in a new design.

PREVIEW: Device has been announced but is not in production. Samples may or may not be available.

OBSOLETE: TI has discontinued the production of the device.

(2) **RoHS:** TI defines "RoHS" to mean semiconductor products that are compliant with the current EU RoHS requirements for all 10 RoHS substances, including the requirement that RoHS substance do not exceed 0.1% by weight in homogeneous materials. Where designed to be soldered at high temperatures, "RoHS" products are suitable for use in specified lead-free processes. TI may reference these types of products as "Pb-Free".

RoHS Exempt: TI defines "RoHS Exempt" to mean products that contain lead but are compliant with EU RoHS pursuant to a specific EU RoHS exemption.

Green: TI defines "Green" to mean the content of Chlorine (Cl) and Bromine (Br) based flame retardants meet JS709B low halogen requirements of <=1000ppm threshold. Antimony trioxide based flame retardants must also meet the <=1000ppm threshold requirement.

(3) MSL, Peak Temp. - The Moisture Sensitivity Level rating according to the JEDEC industry standard classifications, and peak solder temperature.

(4) There may be additional marking, which relates to the logo, the lot trace code information, or the environmental category on the device.

(5) Multiple Device Markings will be inside parentheses. Only one Device Marking contained in parentheses and separated by a "~" will appear on a device. If a line is indented then it is a continuation of the previous line and the two combined represent the entire Device Marking for that device.

⁽⁶⁾ Lead finish/Ball material - Orderable Devices may have multiple material finish options. Finish options are separated by a vertical ruled line. Lead finish/Ball material values may wrap to two lines if the finish value exceeds the maximum column width.

Important Information and Disclaimer: The information provided on this page represents TI's knowledge and belief as of the date that it is provided. TI bases its knowledge and belief on information provided by third parties, and makes no representation or warranty as to the accuracy of such information. Efforts are underway to better integrate information from third parties. TI has taken and continues to take reasonable steps to provide representative and accurate information but may not have conducted destructive testing or chemical analysis on incoming materials and chemicals. TI and TI suppliers consider certain information to be proprietary, and thus CAS numbers and other limited information may not be available for release.

In no event shall TI's liability arising out of such information exceed the total purchase price of the TI part(s) at issue in this document sold by TI to Customer on an annual basis.

TAPE AND REEL INFORMATION

QUADRANT ASSIGNMENTS FOR PIN 1 ORIENTATION IN TAPE

*All dimensions are nominal

| Device | Package Type | Package Drawing | Pins | SPQ | Reel Diameter (mm) | Reel Width W1 (mm) | A0 (mm) | B0 (mm) | K0 (mm) | P1 (mm) | W (mm) | Pin1 Quadrant |
|--------------|--------------|-----------------|------|------|--------------------|--------------------|---------|---------|---------|---------|--------|---------------|
| TLV76012DBZR | SOT-23 | DBZ | 3 | 3000 | 178.0 | 8.4 | 3.3 | 2.9 | 1.22 | 4.0 | 8.0 | Q3 |
| TLV76012DBZT | SOT-23 | DBZ | 3 | 250 | 178.0 | 8.4 | 3.3 | 2.9 | 1.22 | 4.0 | 8.0 | Q3 |
| TLV76015DBZR | SOT-23 | DBZ | 3 | 3000 | 178.0 | 8.4 | 3.3 | 2.9 | 1.22 | 4.0 | 8.0 | Q3 |
| TLV76015DBZT | SOT-23 | DBZ | 3 | 250 | 178.0 | 8.4 | 3.3 | 2.9 | 1.22 | 4.0 | 8.0 | Q3 |
| TLV76033DBZR | SOT-23 | DBZ | 3 | 3000 | 178.0 | 8.4 | 3.3 | 2.9 | 1.22 | 4.0 | 8.0 | Q3 |
| TLV76033DBZT | SOT-23 | DBZ | 3 | 250 | 178.0 | 8.4 | 3.3 | 2.9 | 1.22 | 4.0 | 8.0 | Q3 |
| TLV76050DBZR | SOT-23 | DBZ | 3 | 3000 | 178.0 | 8.4 | 3.3 | 2.9 | 1.22 | 4.0 | 8.0 | Q3 |
| TLV76050DBZT | SOT-23 | DBZ | 3 | 250 | 178.0 | 8.4 | 3.3 | 2.9 | 1.22 | 4.0 | 8.0 | Q3 |

TAPE AND REEL BOX DIMENSIONS

*All dimensions are nominal

| Device | Package Type | Package Drawing | Pins | SPQ | Length (mm) | Width (mm) | Height (mm) |
|--------------|--------------|-----------------|------|------|-------------|------------|-------------|
| TLV76012DBZR | SOT-23 | DBZ | 3 | 3000 | 208.0 | 191.0 | 35.0 |
| TLV76012DBZT | SOT-23 | DBZ | 3 | 250 | 208.0 | 191.0 | 35.0 |
| TLV76015DBZR | SOT-23 | DBZ | 3 | 3000 | 208.0 | 191.0 | 35.0 |
| TLV76015DBZT | SOT-23 | DBZ | 3 | 250 | 208.0 | 191.0 | 35.0 |
| TLV76033DBZR | SOT-23 | DBZ | 3 | 3000 | 208.0 | 191.0 | 35.0 |
| TLV76033DBZT | SOT-23 | DBZ | 3 | 250 | 208.0 | 191.0 | 35.0 |
| TLV76050DBZR | SOT-23 | DBZ | 3 | 3000 | 208.0 | 191.0 | 35.0 |
| TLV76050DBZT | SOT-23 | DBZ | 3 | 250 | 208.0 | 191.0 | 35.0 |

DBZ0003A



PACKAGE OUTLINE

SOT-23 - 1.12 mm max height

SMALL OUTLINE TRANSISTOR

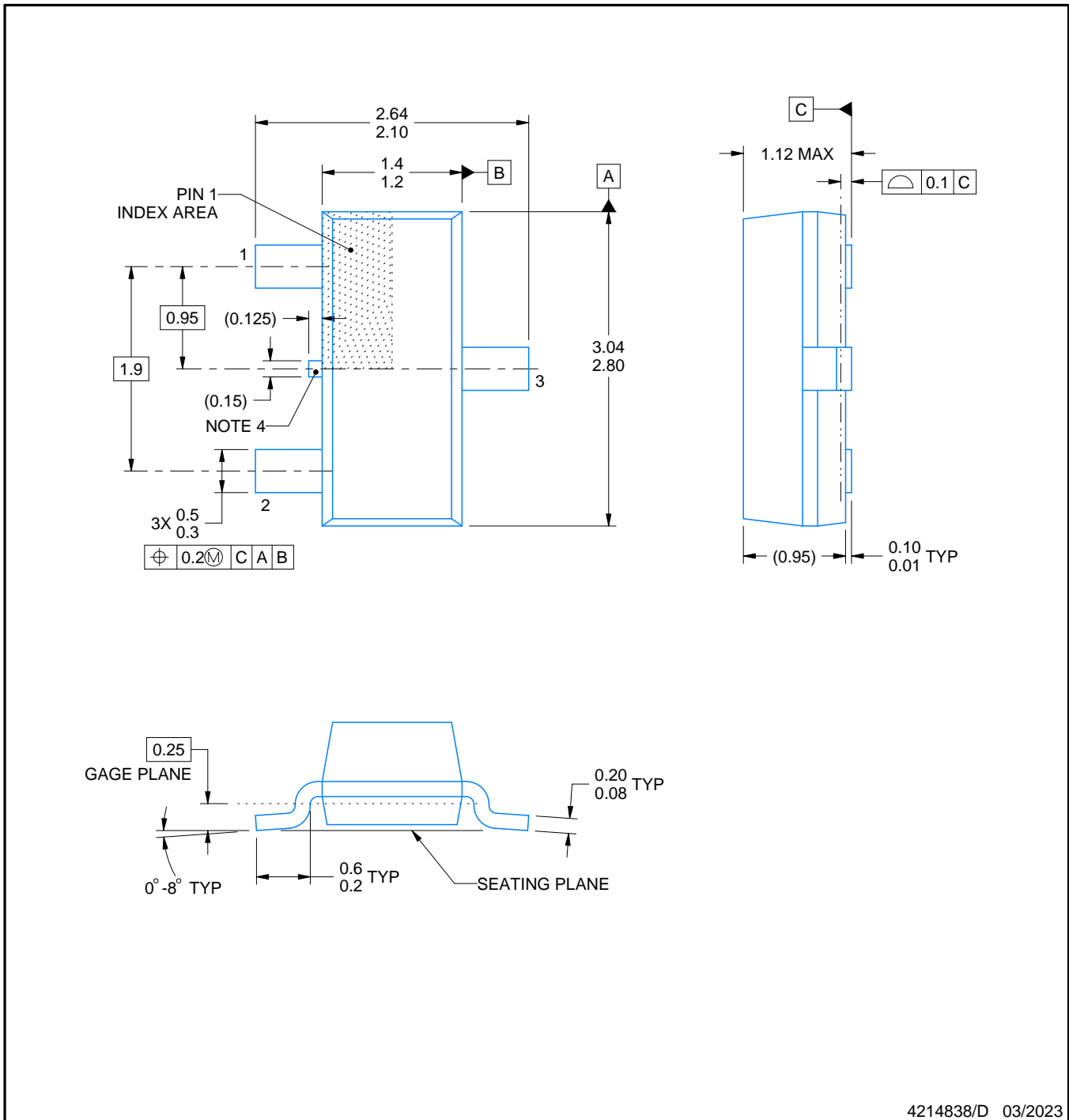

4214838/D 03/2023

NOTES:

1. All linear dimensions are in millimeters. Any dimensions in parenthesis are for reference only. Dimensioning and tolerancing per ASME Y14.5M.
2. This drawing is subject to change without notice.
3. Reference JEDEC registration TO-236, except minimum foot length.
4. Support pin may differ or may not be present.

EXAMPLE BOARD LAYOUT

DBZ0003A

SOT-23 - 1.12 mm max height

SMALL OUTLINE TRANSISTOR

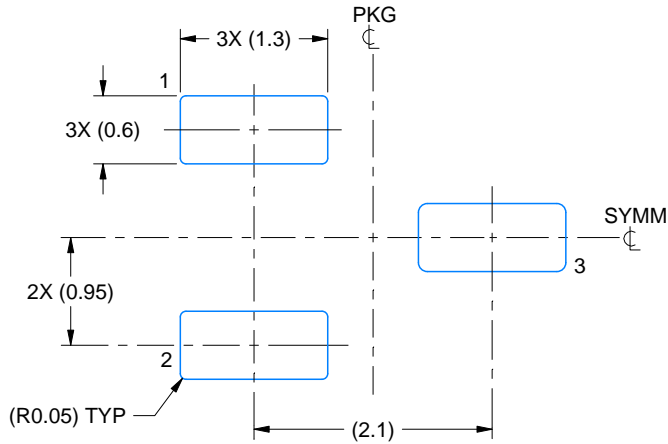

LAND PATTERN EXAMPLE
SCALE:15X



SOLDER MASK DETAILS

4214838/D 03/2023

NOTES: (continued)

4. Publication IPC-7351 may have alternate designs.
5. Solder mask tolerances between and around signal pads can vary based on board fabrication site.

EXAMPLE STENCIL DESIGN

DBZ0003A

SOT-23 - 1.12 mm max height

SMALL OUTLINE TRANSISTOR

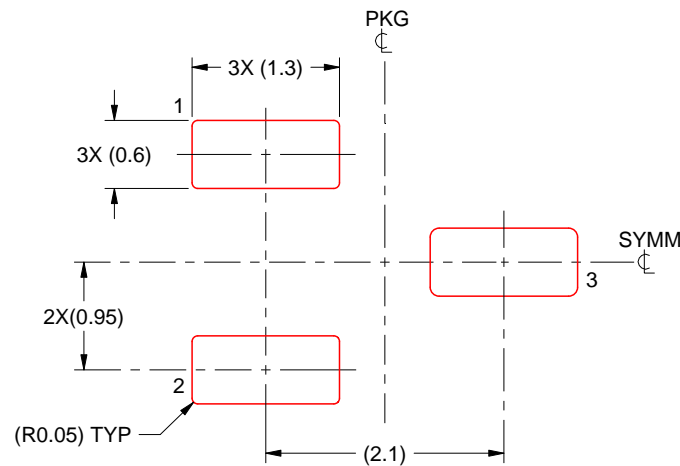

SOLDER PASTE EXAMPLE
BASED ON 0.125 THICK STENCIL
SCALE:15X

4214838/D 03/2023

NOTES: (continued)

6. Laser cutting apertures with trapezoidal walls and rounded corners may offer better paste release. IPC-7525 may have alternate design recommendations.
7. Board assembly site may have different recommendations for stencil design.

重要声明和免责声明

TI“按原样”提供技术和可靠性数据（包括数据表）、设计资源（包括参考设计）、应用或其他设计建议、网络工具、安全信息和其他资源，不保证没有瑕疵且不做任何明示或暗示的担保，包括但不限于对适销性、某特定用途方面的适用性或不侵犯任何第三方知识产权的暗示担保。

这些资源可供使用 TI 产品进行设计的熟练开发人员使用。您将自行承担以下全部责任：(1) 针对您的应用选择合适的 TI 产品，(2) 设计、验证并测试您的应用，(3) 确保您的应用满足相应标准以及任何其他功能安全、信息安全、监管或其他要求。

这些资源如有变更，恕不另行通知。TI 授权您仅可将这些资源用于研发本资源所述的 TI 产品的应用。严禁对这些资源进行其他复制或展示。您无权使用任何其他 TI 知识产权或任何第三方知识产权。您应全额赔偿因在这些资源的使用中对 TI 及其代表造成的任何索赔、损害、成本、损失和债务，TI 对此概不负责。

TI 提供的产品受 [TI 的销售条款](#) 或 [ti.com](#) 上其他适用条款/TI 产品随附的其他适用条款的约束。TI 提供这些资源并不会扩展或以其他方式更改 TI 针对 TI 产品发布的适用的担保或担保免责声明。

TI 反对并拒绝您可能提出的任何其他或不同的条款。

邮寄地址：Texas Instruments, Post Office Box 655303, Dallas, Texas 75265

Copyright © 2023，德州仪器 (TI) 公司