

TPS22932B Low Input Voltage, Ultralow r_{ON} Load Switch With Configurable Enable Logic and Controlled Slew-Rate

1 Features

- Input Voltage: 1.1 V to 3.6 V
- Ultralow ON-Resistance
 - $r_{ON} = 55 \text{ m}\Omega$ at $V_{IN} = 3.6 \text{ V}$
 - $r_{ON} = 65 \text{ m}\Omega$ at $V_{IN} = 2.5 \text{ V}$
 - $r_{ON} = 75 \text{ m}\Omega$ at $V_{IN} = 1.8 \text{ V}$
 - $r_{ON} = 115 \text{ m}\Omega$ at $V_{IN} = 1.2 \text{ V}$
- 500-mA Maximum Continuous Switch Current
- Quiescent Current $< 1 \mu\text{A}$
- Shutdown Current $< 1 \mu\text{A}$
- Low Control Threshold Allows Use of 1.2-V, 1.8-V, 2.5-V, and 3.3-V Logic
- Configurable Enable Logic
- Controlled Slew Rate to Avoid Inrush Currents: 165 μs at 1.8 V
- Six-Terminal Wafer Chip Scale Package (DSBGA)
- ESD Performance Tested Per JESD 22
 - 2000-V Human-Body Model (A114-B, Class II)
 - 1000-V Charged-Device Model (C101)

2 Applications

- PDAs
- Cell Phones
- GPS Devices
- MP3 Players
- Digital Cameras
- Peripheral Ports
- Portable Instrumentation

3 Description

The TPS22932B device is a low r_{ON} load switch with controlled turnon. The device contains a P-channel MOSFET that can operate over an input voltage range of 1.1 V to 3.6 V.

The switch is controlled by eight patterns of 3-bit input. The user can choose the logic functions MUX, AND, OR, NAND, NOR, inverter, and noninverter. All inputs can be connected to V_{IN} or GND. The control pins can be connected to low-voltage GPIOs allowing the switch to be controlled by either 1.2-V, 1.8-V, 2.5-V, or 3.3-V logic signals while keeping extremely low quiescent current.

A 120- Ω on-chip load resistor is available for output quick discharge when the switch is turned off. The rise time (slew rate) of the device is internally controlled to avoid inrush current: the rise time of TPS22932B is 165 μs .

TPS22932B is available in a space-saving 6-pin DSBGA (YFP with 0.4-mm pitch). The device is characterized for operation over the free-air temperature range of -40°C to 85°C .

Device Information⁽¹⁾

PART NUMBER	PACKAGE	BODY SIZE (NOM)
TPS22932B	DSBGA (6)	0.80 mm x 1.20 mm

(1) For all available packages, see the orderable addendum at the end of the data sheet.

Typical Application

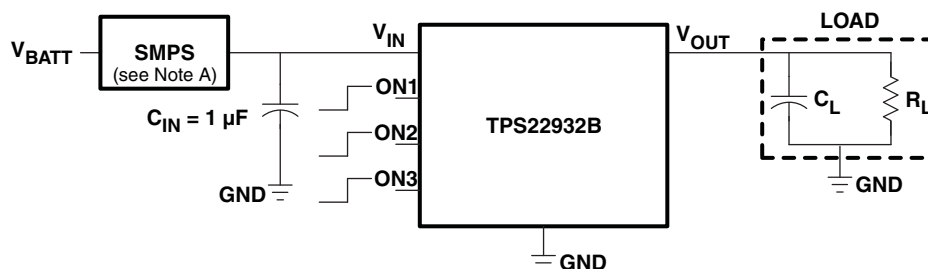

A. Switched-mode power supply



Table of Contents

1 Features 1 2 Applications 1 3 Description 1 4 Revision History 2 5 Device Comparison Table 3 6 Pin Configuration and Functions 3 7 Specifications 3 7.1 Absolute Maximum Ratings 3 7.2 ESD Ratings..... 3 7.3 Recommended Operating Conditions 4 7.4 Thermal Information 4 7.5 Electrical Characteristics..... 4 7.6 Switching Characteristics, 1.2 V 5 7.7 Switching Characteristics, 1.5 V 5 7.8 Switching Characteristics, 1.8 V 6 7.9 Switching Characteristics, 2.5 V 6 7.10 Switching Characteristics, 3 V 6 7.11 Switching Characteristics, 3.3 V 7 7.12 Typical Characteristics 8	8 Parameter Measurement information 13 9 Detailed Description 14 9.1 Overview 14 9.2 Functional Block Diagram 14 9.3 Feature Description..... 14 9.4 Device Functional Modes..... 15 10 Application and Implementation 17 10.1 Application Information..... 17 10.2 Typical Application 17 11 Power Supply Recommendations 19 12 Layout 19 12.1 Layout Guidelines 19 12.2 Layout Example 20 13 Device and Documentation Support 21 13.1 Community Resources..... 21 13.2 Trademarks 21 13.3 Electrostatic Discharge Caution..... 21 13.4 Glossary 21 14 Mechanical, Packaging, and Orderable Information 21
--	--

4 Revision History

NOTE: Page numbers for previous revisions may differ from page numbers in the current version.

Changes from Revision B (August 2013) to Revision C	Page
<ul style="list-style-type: none"> • Added <i>Pin Configuration and Functions</i> section, <i>ESD Ratings</i> table, <i>Feature Description</i> section, <i>Device Functional Modes</i>, <i>Application and Implementation</i> section, <i>Power Supply Recommendations</i> section, <i>Layout</i> section, <i>Device and Documentation Support</i> section, and <i>Mechanical, Packaging, and Orderable Information</i> section 1 • Moved Operating free-air temperature values in <i>Absolute Maximum Ratings</i> to the <i>Recommended Operating Conditions</i> 4 	

Changes from Revision A (November 2009) to Revision B	Page
<ul style="list-style-type: none"> • Aligned package description throughout data sheet. 1 	

5 Device Comparison Table

DEVICE	r_{ON} at 1.8 V (TYP)	SLEW RATE (TYP at 3.3 V)	QUICK OUTPUT DISCHARGE ⁽¹⁾	MAX OUTPUT CURRENT	ENABLE
TPS22932B	75 m Ω	165 μ s	Yes	500 mA	Active High

(1) This feature discharges the output of the switch to ground through a 120- Ω resistor, preventing the output from floating.

6 Pin Configuration and Functions

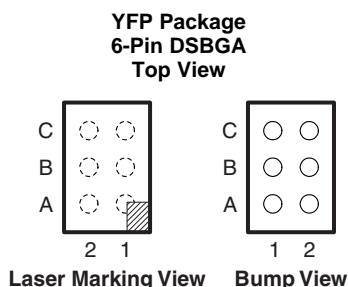

Pin Functions

PIN		I/O	DESCRIPTION
NO.	NAME		
A1	V_{OUT}	O	Switch output
A2	V_{IN}	I	Switch input, bypass this input with a ceramic capacitor to ground
B1	GND	—	Ground
B2	ON1	I	Switch control input, active high - Do not leave floating
C2	ON2		
C1	ON3		

7 Specifications

7.1 Absolute Maximum Ratings

over operating free-air temperature range (unless otherwise noted) ⁽¹⁾

		MIN	MAX	UNIT
V_{IN}	Input voltage	-0.3	4	V
V_{OUT}	Output voltage		$V_{IN} + 0.3$	V
I_{MAX}	Maximum continuous switch current		500	mA
T_{lead}	Maximum lead temperature (10-s soldering time)		300	$^{\circ}$ C
T_{stg}	Storage temperature	-65	150	$^{\circ}$ C

(1) Stresses beyond those listed under *Absolute Maximum Ratings* may cause permanent damage to the device. These are stress ratings only, which do not imply functional operation of the device at these or any other conditions beyond those indicated under *Recommended Operating Conditions*. Exposure to absolute-maximum-rated conditions for extended periods may affect device reliability.

7.2 ESD Ratings

		VALUE	UNIT
$V_{(ESD)}$	Electrostatic discharge	Human-body model (HBM), per ANSI/ESDA/JEDEC JS-001 ⁽¹⁾	\pm 2000
		Charged-device model (CDM), per JEDEC specification JESD22-C101 ⁽²⁾	\pm 1000

(1) JEDEC document JEP155 states that 500-V HBM allows safe manufacturing with a standard ESD control process.

(2) JEDEC document JEP157 states that 250-V CDM allows safe manufacturing with a standard ESD control process.

7.3 Recommended Operating Conditions

over operating free-air temperature range (unless otherwise noted)

		MIN	MAX	UNIT
I_{OUT}	Output current		500	mA
V_{IN}	Input voltage	1.1	3.6	V
V_{OUT}	Output voltage		V_{IN}	
C_{IN}	Input capacitor	1 ⁽¹⁾		μF
T_A	Operating free-air temperature	–40	85	°C

 (1) See [Application Information](#).

7.4 Thermal Information

THERMAL METRIC ⁽¹⁾		TPS22932B		UNIT
		YFP (DSBGA)		
		6 PINS		
$R_{\theta JA}$	Junction-to-ambient thermal resistance	125.1		°C/W
$R_{\theta JC(top)}$	Junction-to-case (top) thermal resistance	1.4		°C/W
$R_{\theta JB}$	Junction-to-board thermal resistance	26		°C/W
Ψ_{JT}	Junction-to-top characterization parameter	0.6		°C/W
Ψ_{JB}	Junction-to-board characterization parameter	26		°C/W
$R_{\theta JC(bot)}$	Junction-to-case (bottom) thermal resistance	—		°C/W

 (1) For more information about traditional and new thermal metrics, see the *Semiconductor and IC Package Thermal Metrics* application report, [SPRA953](#).

7.5 Electrical Characteristics

 $V_{IN} = 1.1\text{ V to }3.6\text{ V}$, $T_A = -40^\circ\text{C to }85^\circ\text{C}$ (unless otherwise noted)

PARAMETER	TEST CONDITIONS	T_A	MIN TYP ⁽¹⁾ MAX		UNIT				
I_{IN}	Quiescent current $I_{OUT} = 0$	Full	$V_{IN} = 1.1\text{ V}$	140	275	nA			
			$V_{IN} = 1.8\text{ V}$	280	500				
			$V_{IN} = 3.6\text{ V}$	860	920				
$I_{IN(OFF)}$	OFF-state supply current $V_{ON} = \text{GND}$, $OUT = \text{Open}$	Full	$V_{IN} = 1.1\text{ V}$	80	225	nA			
			$V_{IN} = 1.8\text{ V}$	125	300				
			$V_{IN} = 3.6\text{ V}$	340	650				
$I_{IN(LEAKAGE)}$	OFF-state switch current $V_{ON} = \text{GND}$, $V_{OUT} = 0$	Full	$V_{IN} = 1.1\text{ V}$	80	225	nA			
			$V_{IN} = 1.8\text{ V}$	125	300				
			$V_{IN} = 3.6\text{ V}$	340	650				
r_{ON}	ON-state resistance $I_{OUT} = -200\text{ mA}$	25°C	Full	$V_{IN} = 3.6\text{ V}$	55	70	mΩ		
					85				
		25°C	Full	$V_{IN} = 2.5\text{ V}$	65	80			
					100				
		25°C	Full	$V_{IN} = 1.8\text{ V}$	75	90			
					110				
		25°C	Full	$V_{IN} = 1.2\text{ V}$	115	130			
					155				
		25°C	Full	$V_{IN} = 1.1\text{ V}$	135	150			
					170				
		r_{PD}	Output pulldown resistance $V_{IN} = 3.3\text{ V}$, $V_{ON} = 0$, $I_{OUT} = 30\text{ mA}$	25°C		75		120	Ω
		I_{ON}	ON-state input leakage current $V_{ON} = 1.1\text{ V to }3.6\text{ V or GND}$	Full				1	μA

Control Inputs (ON1, ON2, ON3)

 (1) Typical values are at the specified V_{IN} and $T_A = 25^\circ\text{C}$.

Electrical Characteristics (continued)

 $V_{IN} = 1.1 \text{ V to } 3.6 \text{ V}$, $T_A = -40^\circ\text{C to } 85^\circ\text{C}$ (unless otherwise noted)

PARAMETER		TEST CONDITIONS	T_A	MIN	TYP ⁽¹⁾	MAX	UNIT
	Input leakage current	$V_{IN} = 1.1 \text{ V to } 3.6 \text{ V or GND}$	Full			1	μA
V_{ON}	Control input voltage		Full			3.6	V
V_{T+}	Positive-going input voltage threshold	$V_{IN} = 1.1 \text{ V to } 1.8 \text{ V}$	Full	0.5		0.8	V
		$V_{IN} = 1.8 \text{ V to } 3.6 \text{ V}$		0.6		0.9	
V_{T-}	Negative-going input voltage threshold	$V_{IN} = 1.1 \text{ V to } 1.8 \text{ V}$	Full	0.2		0.6	V
		$V_{IN} = 1.8 \text{ V to } 3.6 \text{ V}$		0.3		0.7	
ΔV_T	Hysteresis ($V_{T+} - V_{T-}$)	$V_{IN} = 1.1 \text{ V to } 3.6 \text{ V}$	Full	0.2		0.6	V

7.6 Switching Characteristics, 1.2 V

 $V_{IN} = 1.2 \text{ V}$, $R_{L_CHIP} = 120 \Omega$, $T_A = 25^\circ\text{C}$ (unless otherwise noted)

PARAMETER		TEST CONDITIONS	MIN	TYP	MAX	UNIT
t_{ON}	Turnon time	$R_L = 500 \Omega$	$C_L = 0.1 \mu\text{F}$		350	μs
			$C_L = 1 \mu\text{F}$		390	
			$C_L = 3 \mu\text{F}$		450	
t_{OFF}	Turnoff time	$R_L = 500 \Omega$	$C_L = 0.1 \mu\text{F}$		30	μs
			$C_L = 1 \mu\text{F}$		70	
			$C_L = 3 \mu\text{F}$		160	
t_r	V_{OUT} rise time	$R_L = 500 \Omega$	$C_L = 0.1 \mu\text{F}$		240	μs
			$C_L = 1 \mu\text{F}$		240	
			$C_L = 3 \mu\text{F}$		260	
t_f	V_{OUT} fall time	$R_L = 500 \Omega$	$C_L = 0.1 \mu\text{F}$		20	μs
			$C_L = 1 \mu\text{F}$		150	
			$C_L = 3 \mu\text{F}$		450	

7.7 Switching Characteristics, 1.5 V

 $V_{IN} = 1.5 \text{ V}$, $R_{L_CHIP} = 120 \Omega$, $T_A = 25^\circ\text{C}$ (unless otherwise noted)

PARAMETER		TEST CONDITIONS	MIN	TYP	MAX	UNIT
t_{ON}	Turnon time	$R_L = 500 \Omega$	$C_L = 0.1 \mu\text{F}$		290	μs
			$C_L = 1 \mu\text{F}$		320	
			$C_L = 3 \mu\text{F}$		350	
t_{OFF}	Turnoff time	$R_L = 500 \Omega$	$C_L = 0.1 \mu\text{F}$		30	μs
			$C_L = 1 \mu\text{F}$		70	
			$C_L = 3 \mu\text{F}$		150	
t_r	V_{OUT} rise time	$R_L = 500 \Omega$	$C_L = 0.1 \mu\text{F}$		205	μs
			$C_L = 1 \mu\text{F}$		205	
			$C_L = 3 \mu\text{F}$		220	
t_f	V_{OUT} fall time	$R_L = 500 \Omega$	$C_L = 0.1 \mu\text{F}$		18	μs
			$C_L = 1 \mu\text{F}$		145	
			$C_L = 3 \mu\text{F}$		445	

7.8 Switching Characteristics, 1.8 V

 $V_{IN} = 1.8\text{ V}$, $R_{L_CHIP} = 120\ \Omega$, $T_A = 25^\circ\text{C}$ (unless otherwise noted)

PARAMETER		TEST CONDITIONS		MIN	TYP	MAX	UNIT
t_{ON}	Turnon time	$R_L = 500\ \Omega$	$C_L = 0.1\ \mu\text{F}$		215		μs
			$C_L = 1\ \mu\text{F}$		240		
			$C_L = 3\ \mu\text{F}$		260		
t_{OFF}	Turnoff time	$R_L = 500\ \Omega$	$C_L = 0.1\ \mu\text{F}$		24		μs
			$C_L = 1\ \mu\text{F}$		60		
			$C_L = 3\ \mu\text{F}$		142		
t_r	V_{OUT} rise time	$R_L = 500$	$C_L = 0.1\ \mu\text{F}$		165		μs
			$C_L = 1\ \mu\text{F}$		165		
			$C_L = 3\ \mu\text{F}$		175		
t_f	V_{OUT} fall time	$R_L = 500\ \Omega$	$C_L = 0.1\ \mu\text{F}$		18		μs
			$C_L = 1\ \mu\text{F}$		145		
			$C_L = 3\ \mu\text{F}$		440		

7.9 Switching Characteristics, 2.5 V

 $V_{IN} = 2.5\text{ V}$, $R_{L_CHIP} = 120\ \Omega$, $T_A = 25^\circ\text{C}$ (unless otherwise noted)

PARAMETER		TEST CONDITIONS		MIN	TYP	MAX	UNIT
t_{ON}	Turnon time	$R_L = 500\ \Omega$	$C_L = 0.1\ \mu\text{F}$		185		μs
			$C_L = 1\ \mu\text{F}$		205		
			$C_L = 3\ \mu\text{F}$		225		
t_{OFF}	Turnoff time	$R_L = 500\ \Omega$	$C_L = 0.1\ \mu\text{F}$		2		μs
			$C_L = 1\ \mu\text{F}$		60		
			$C_L = 3\ \mu\text{F}$		140		
t_r	V_{OUT} rise time	$R_L = 500\ \Omega$	$C_L = 0.1\ \mu\text{F}$		145		μs
			$C_L = 1\ \mu\text{F}$		150		
			$C_L = 3\ \mu\text{F}$		160		
t_f	V_{OUT} fall time	$R_L = 500\ \Omega$	$C_L = 0.1\ \mu\text{F}$		18		μs
			$C_L = 1\ \mu\text{F}$		147		
			$C_L = 3\ \mu\text{F}$		445		

7.10 Switching Characteristics, 3 V

 $V_{IN} = 3\text{ V}$, $R_{L_CHIP} = 120\ \Omega$, $T_A = 25^\circ\text{C}$ (unless otherwise noted)

PARAMETER		TEST CONDITIONS		MIN	TYP	MAX	UNIT
t_{ON}	Turnon time	$R_L = 500\ \Omega$	$C_L = 0.1\ \mu\text{F}$		170		μs
			$C_L = 1\ \mu\text{F}$		190		
			$C_L = 3\ \mu\text{F}$		210		
t_{OFF}	Turnoff time	$R_L = 500\ \Omega$	$C_L = 0.1\ \mu\text{F}$		2		μs
			$C_L = 1\ \mu\text{F}$		60		
			$C_L = 3\ \mu\text{F}$		140		
t_r	V_{OUT} rise time	$R_L = 500\ \Omega$	$C_L = 0.1\ \mu\text{F}$		140		μs
			$C_L = 1\ \mu\text{F}$		140		
			$C_L = 3\ \mu\text{F}$		150		
t_f	V_{OUT} fall time	$R_L = 500\ \Omega$	$C_L = 0.1\ \mu\text{F}$		17		μs
			$C_L = 1\ \mu\text{F}$		148		
			$C_L = 3\ \mu\text{F}$		450		

7.11 Switching Characteristics, 3.3 V

 $V_{IN} = 3.3\text{ V}$, $R_{L_CHIP} = 120\ \Omega$, $T_A = 25^\circ\text{C}$ (unless otherwise noted)

PARAMETER		TEST CONDITIONS			MIN	TYP	MAX	UNIT
t_{ON}	Turnon time	$R_L = 500\ \Omega$	$C_L = 0.1\ \mu\text{F}$		160		μs	
			$C_L = 1\ \mu\text{F}$		175			
			$C_L = 3\ \mu\text{F}$		195			
t_{OFF}	Turnoff time	$R_L = 500\ \Omega$	$C_L = 0.1\ \mu\text{F}$		20		μs	
			$C_L = 1\ \mu\text{F}$		55			
			$C_L = 3\ \mu\text{F}$		135			
t_r	V_{OUT} rise time	$R_L = 500\ \Omega$	$C_L = 0.1\ \mu\text{F}$		135		μs	
			$C_L = 1\ \mu\text{F}$		135			
			$C_L = 3\ \mu\text{F}$		145			
t_f	V_{OUT} fall time	$R_L = 500\ \Omega$	$C_L = 0.1\ \mu\text{F}$		17		μs	
			$C_L = 1\ \mu\text{F}$		148			
			$C_L = 3\ \mu\text{F}$		450			

7.12 Typical Characteristics

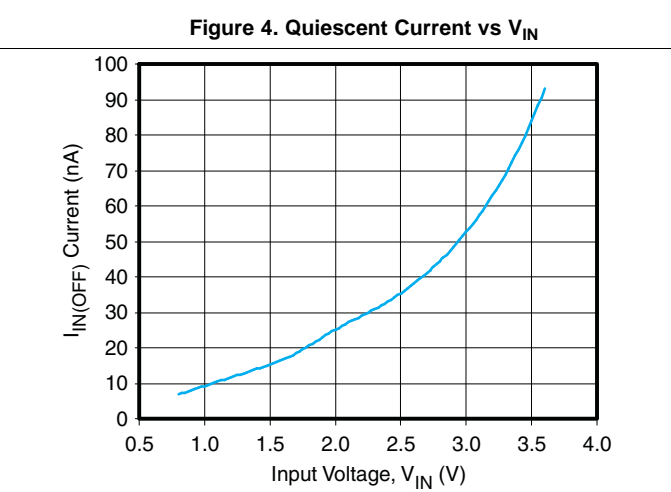
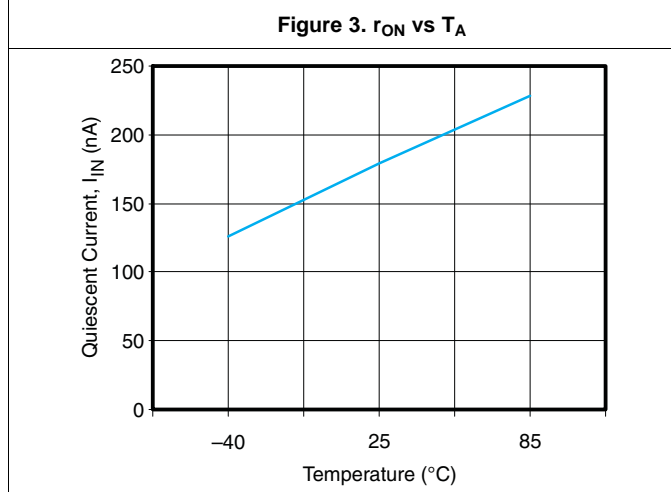
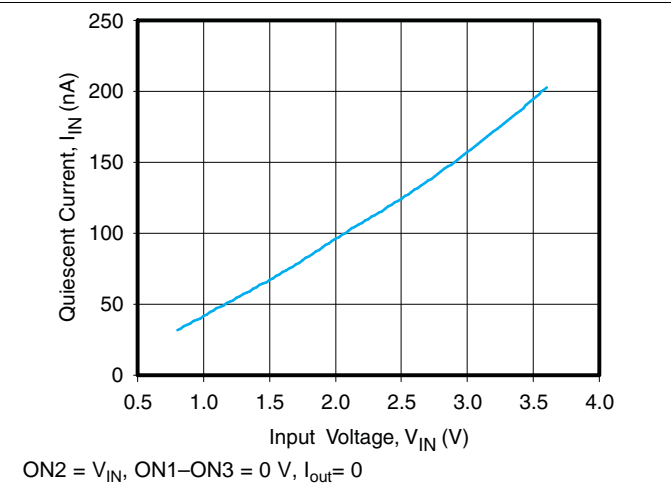
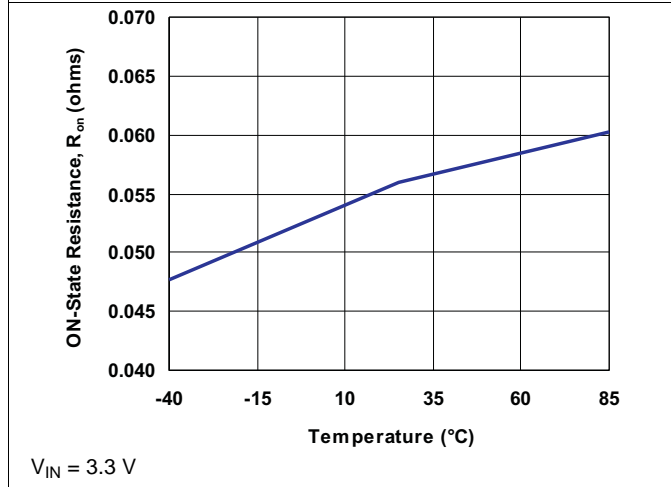
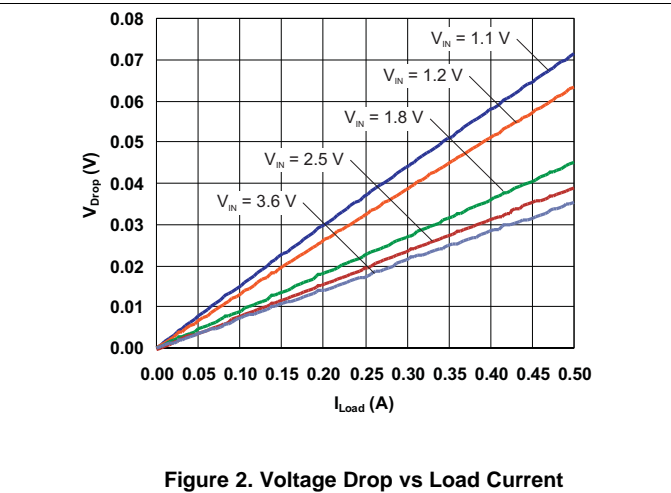
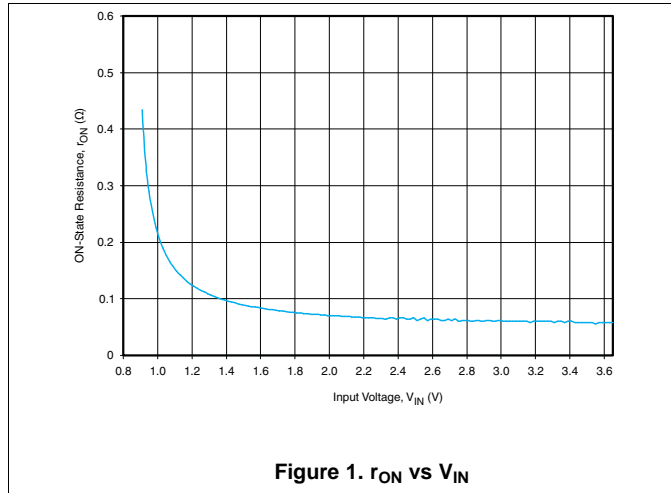

Typical Characteristics (continued)

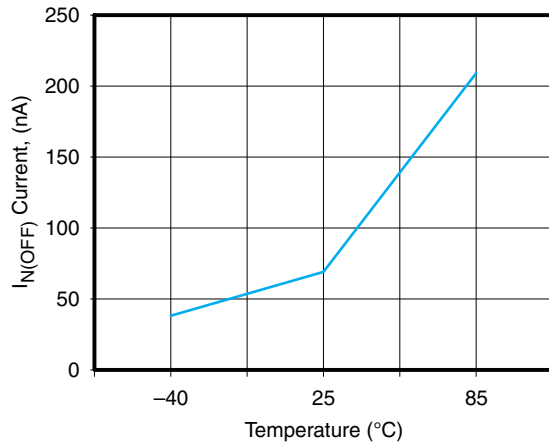

$V_{IN} = 3.3\text{ V}$, $ON1-ON2-ON3 = 0\text{ V}$

Figure 7. $I_{IN(OFF)}$ vs Temperature

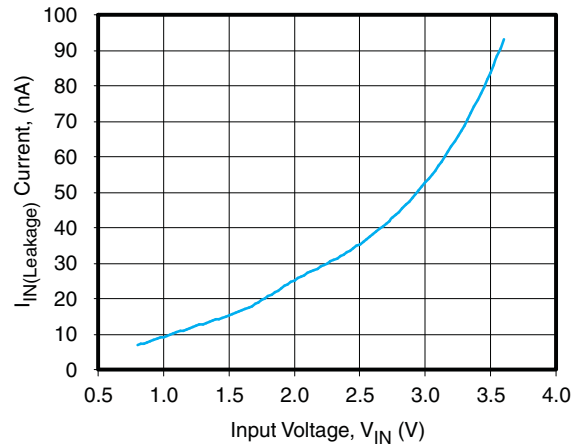

$ON1-ON2-ON3 = 0\text{ V}$, $V_{out} = 0$

Figure 8. $I_{IN(Leakage)}$ vs V_{IN}

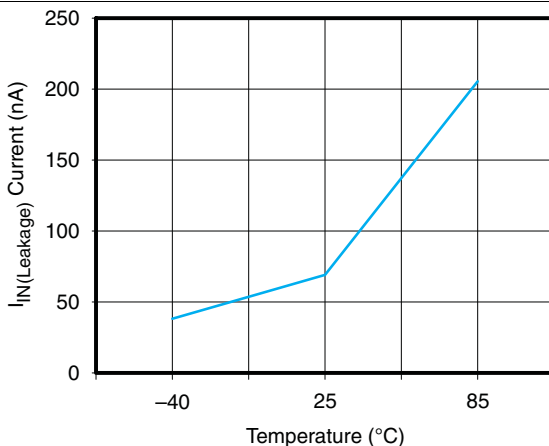

$V_{IN} = 3.3\text{ V}$, $ON1-ON2-ON3 = 0\text{ V}$

Figure 9. $I_{IN(Leakage)}$ vs Temperature

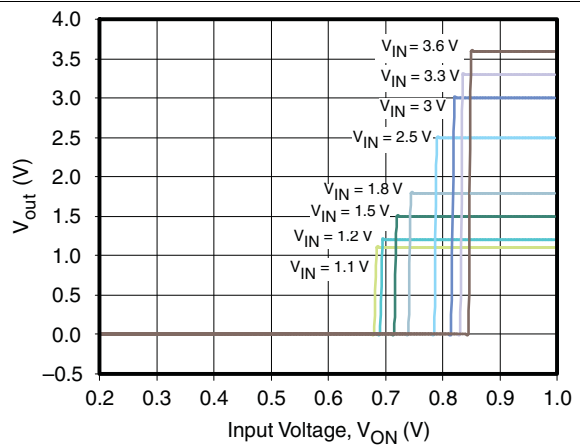
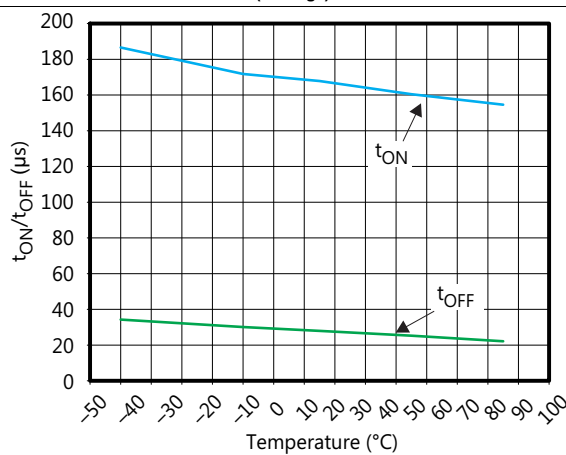
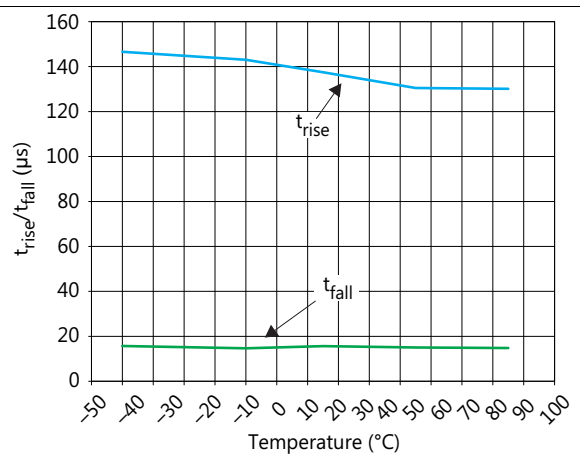

Figure 10. ON-Input Threshold



$C_L = 0.1\text{ }\mu\text{F}$, $R_L = 500\text{ }\Omega$, $V_{IN} = 3.3\text{ V}$

Figure 11. t_{ON}/t_{OFF} vs Temperature



$C_L = 0.1\text{ }\mu\text{F}$, $R_L = 500\text{ }\Omega$, $V_{IN} = 3.3\text{ V}$

Figure 12. t_{rise}/t_{fall} vs Temperature

Typical Characteristics (continued)

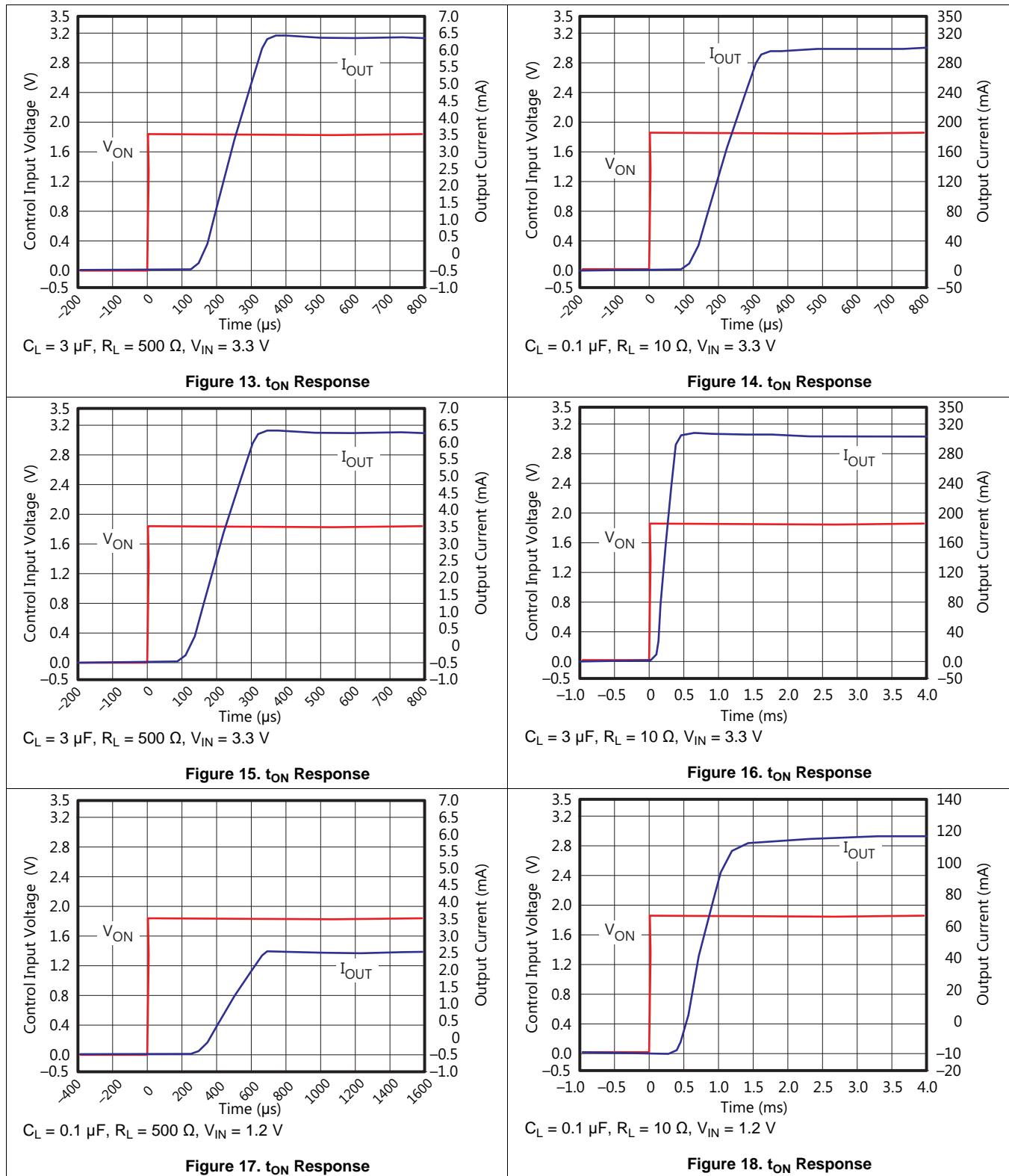

Typical Characteristics (continued)

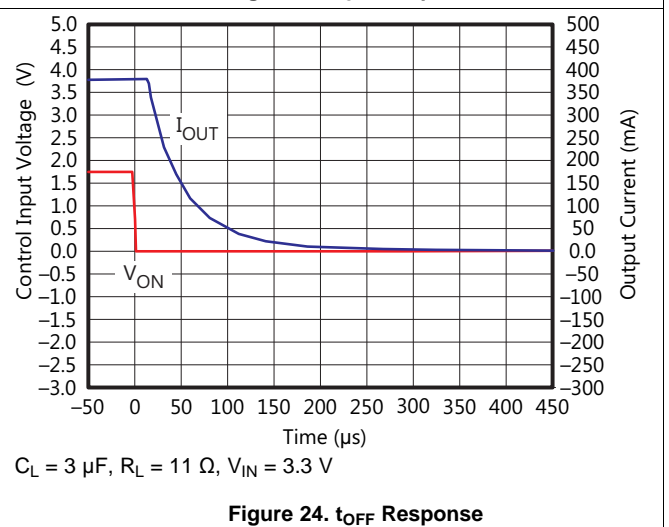
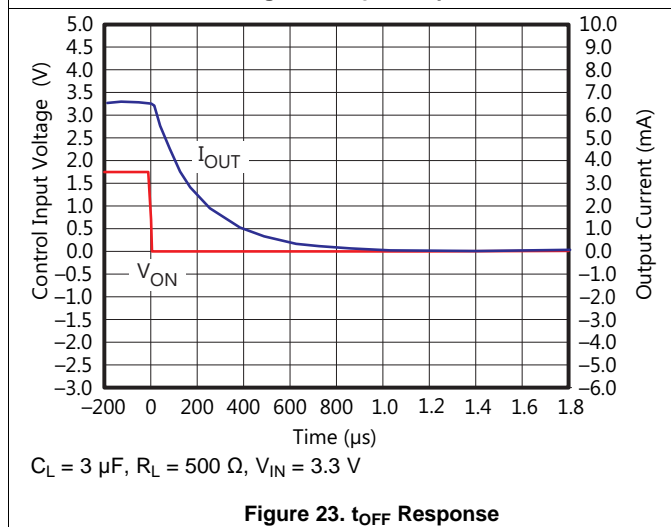
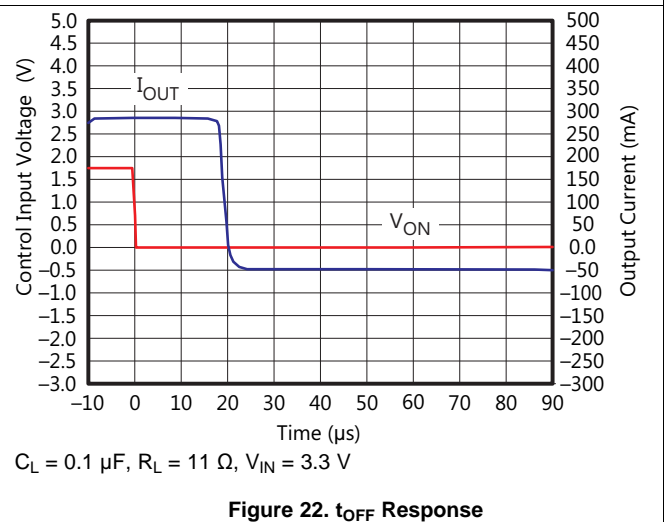
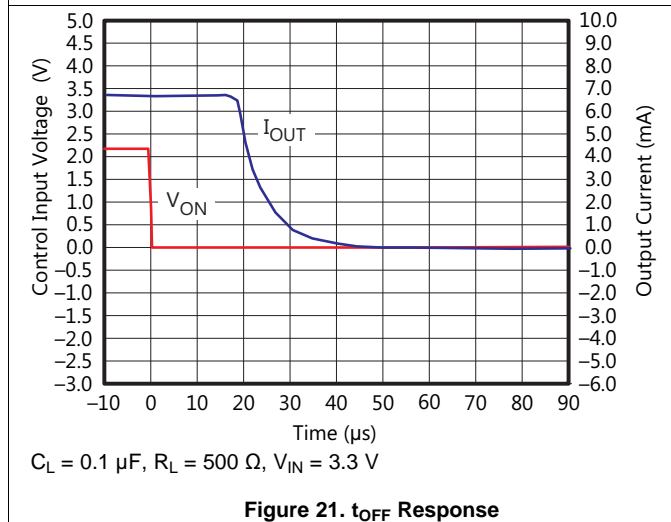
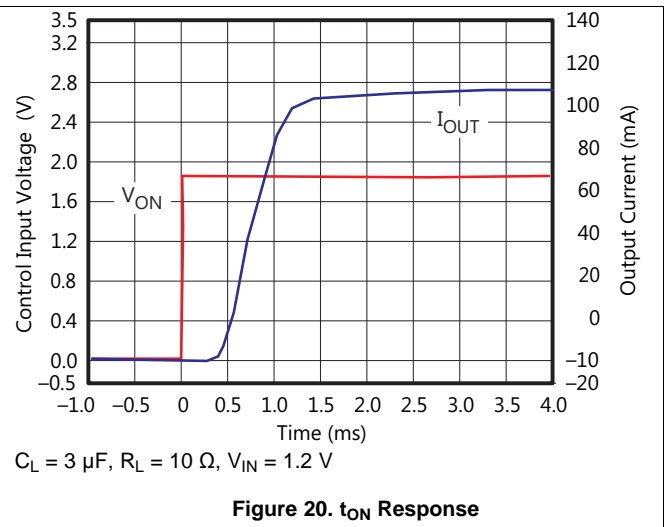
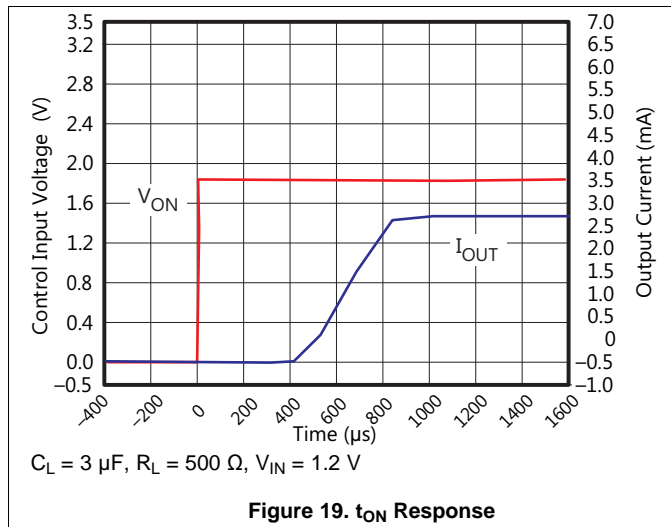

Typical Characteristics (continued)

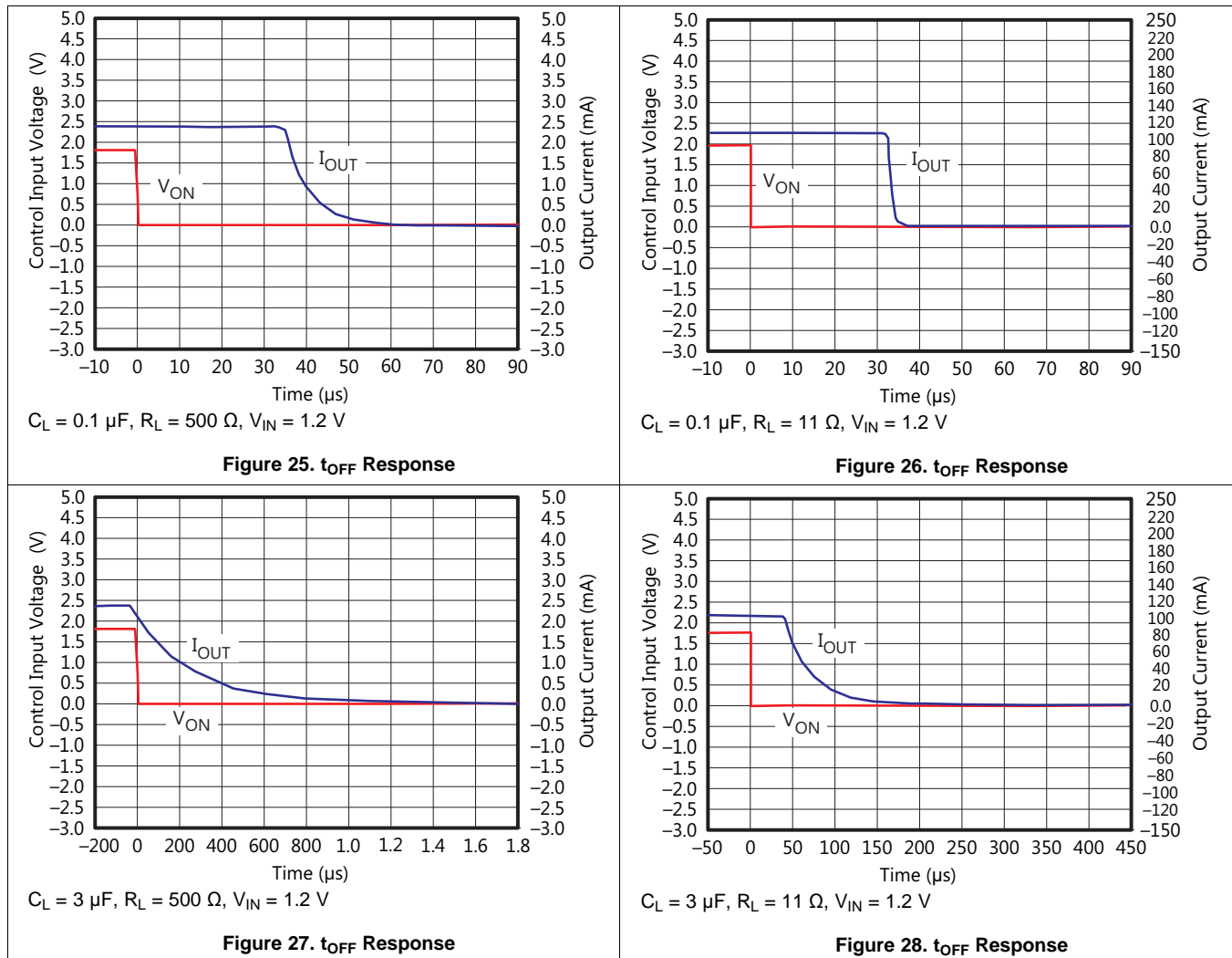

8 Parameter Measurement information

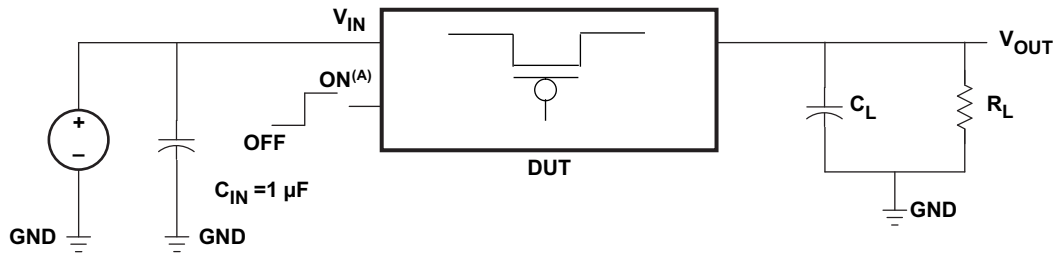

A. t_{rise} and t_{fall} of the control signal is 100 ns.

Figure 29. Test Circuit

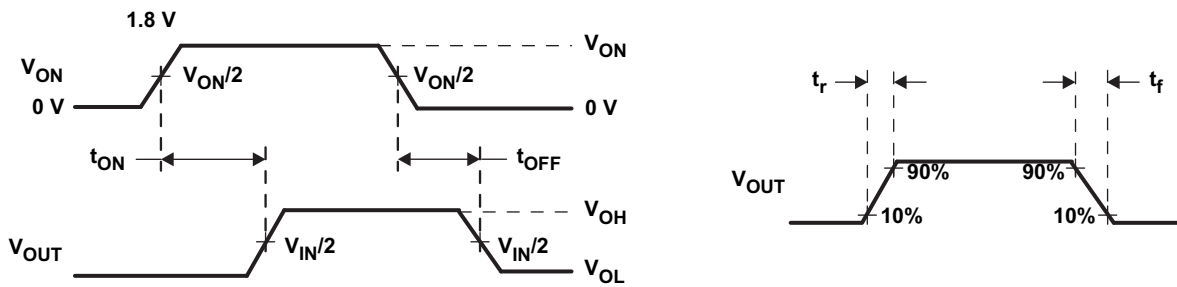

A. t_{rise} and t_{fall} of the control signal is 100 ns.

Figure 30. t_{ON}/t_{OFF} Waveforms

9 Detailed Description

9.1 Overview

TPS22932B is a single-channel, low r_{ON} load switch with controlled turnon. The device contains a low r_{ON} P-channel MOSFET that can operate over an input voltage range of 1.1 V to 3.6 V. The switch is controlled by eight patterns of 3-bit input. The user can choose the logic functions MUX, AND, OR, NAND, NOR, inverter, and noninverter. All inputs can be connected to V_{IN} or GND. The control pins can be connected to low-voltage GPIOs allowing it to be controlled by either 1.2-V, 1.8-V, 2.5-V, or 3.3-V logic signals while keeping extremely low quiescent current. A 120- Ω on-chip load resistor is available for output quick discharge when the switch is turned off. The rise time (slew rate) of the device is internally controlled to avoid inrush current.

9.2 Functional Block Diagram

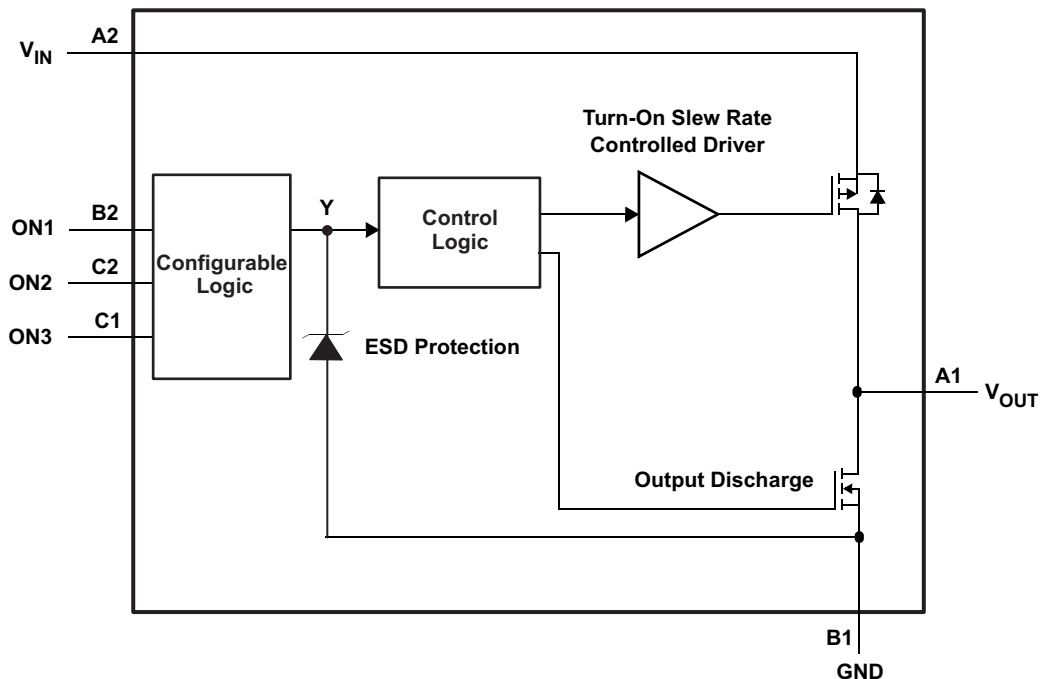

9.3 Feature Description

9.3.1 Configurable Logic Function

The switch is controlled by eight patterns of 3-bit input. The user can choose the logic functions MUX, AND, OR, NAND, NOR, inverter, and noninverter. All inputs can be connected to V_{IN} or GND. The control pins can be connected to low-voltage GPIOs allowing it to be controlled by either 1.2-V, 1.8-V, 2.5-V, or 3.3-V logic signals while keeping extremely low quiescent current.

9.3.2 Quick Output Discharge

The TPS22932B includes the Quick Output Discharge (QOD) feature. When the switch is disabled, a discharge resistance with a typical value of 120 Ω is connected between the output and ground. This resistance pulls down the output and prevents it from floating when the device is disabled.

9.4 Device Functional Modes

9.4.1 Logic Configurations

Table 1. Configurable Logic Function Table

INPUTS			SWITCH CONTROL
ON3	ON2	ON1	Y
L	L	L	OFF
L	L	H	OFF
L	H	L	ON
L	H	H	ON
H	L	L	OFF
H	L	H	ON
H	H	L	OFF
H	H	H	ON

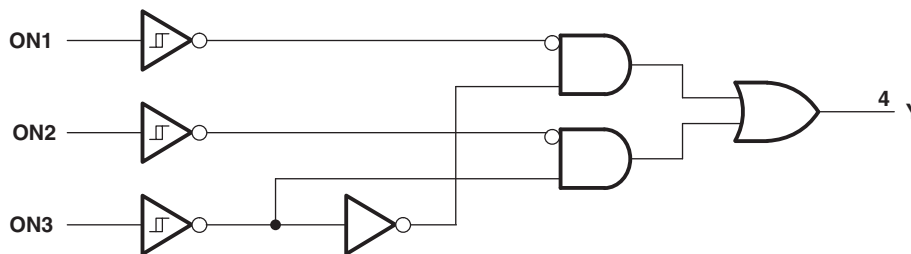

Figure 31. Logic Diagram (Positive Logic)

Table 2. Function Selection Table

LOGIC FUNCTION	FIGURE NO.
2-to-1 data selector	Figure 32
2-input AND gate	Figure 33
2-input OR gate with one inverted input	Figure 34
2-input NAND gate with one inverted input	Figure 34
2-input AND gate with one inverted input	Figure 35
2-input NOR gate with one inverted input	Figure 35
2-input OR gate	Figure 36
Inverter	Figure 37
Noninverted buffer	Figure 38

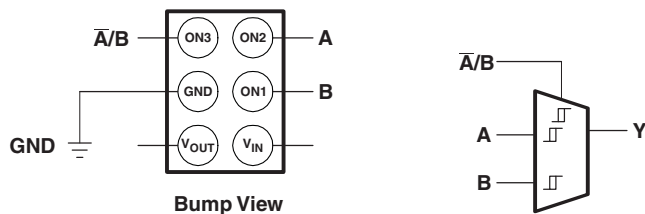

Figure 32. 2-to-1 Data Selector

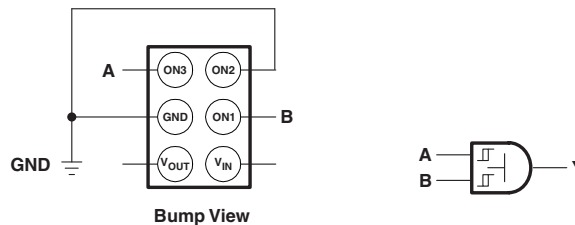

Figure 33. 2-Input AND Gate

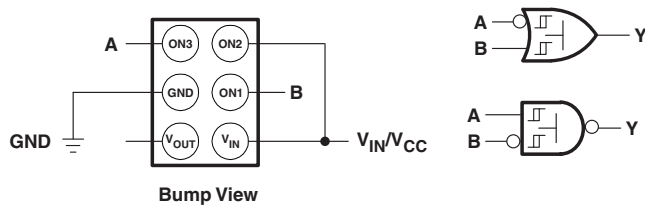

Figure 34. 2-Input OR Gate With One Inverted Input, 2-Input NAND Gate With One Inverted Input

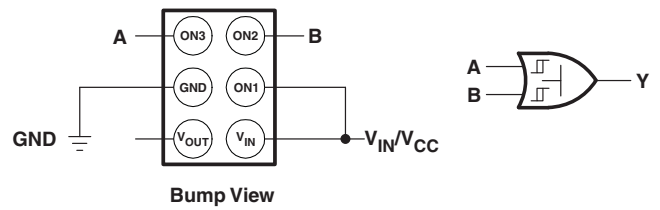

Figure 36. 2-Input OR Gate

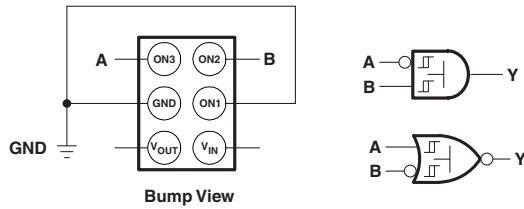

Figure 35. 2-Input AND Gate With One Inverted Input, 2-Input NOR Gate With One Inverted Input

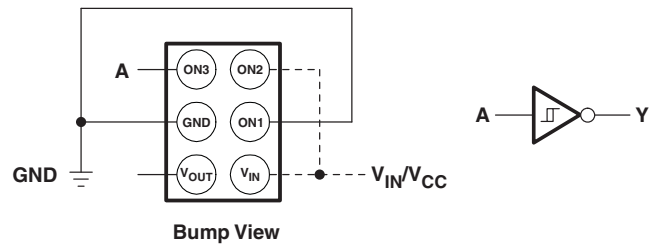

Figure 37. Inverter

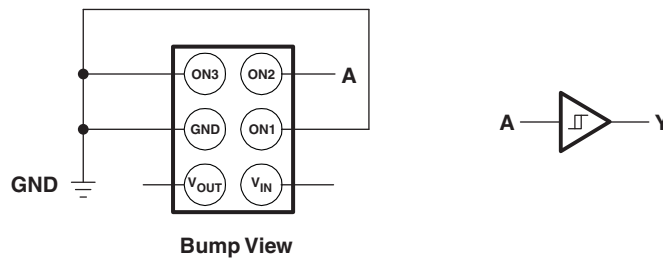

Figure 38. Noninverted Buffer

10 Application and Implementation

NOTE

Information in the following applications sections is not part of the TI component specification, and TI does not warrant its accuracy or completeness. TI's customers are responsible for determining suitability of components for their purposes. Customers should validate and test their design implementation to confirm system functionality.

10.1 Application Information

10.1.1 ON and OFF Control

The ON pin controls the state of the switch. Activating ON continuously holds the switch in the on state so long as there is no fault. ON is active HI and has a low threshold making it capable of interfacing with low voltage signals. The ON pin is compatible with standard GPIO logic threshold. It can be used with any microcontroller with 1.2-V, 1.8-V, 2.5-V, or 3.3-V GPIOs.

10.1.2 Input Capacitor

To limit the voltage drop on the input supply caused by transient in-rush currents when the switch turns on into a discharged load capacitor or short-circuit, a capacitor must be placed between V_{IN} and GND. A 1- μ F ceramic capacitor, C_{IN} , placed close to the pins is usually sufficient. Higher values of C_{IN} can be used to further reduce the voltage drop during higher current application. When switching a heavy load, TI recommends to have an input capacitor about 10 or more times higher than the output capacitor to avoid any supply drop.

10.1.3 Output Capacitor

Due to the integral body diode in the PMOS switch, a C_{IN} greater than C_L is highly recommended. A C_L greater than C_{IN} can cause V_{OUT} to exceed V_{IN} when the system supply is removed. This could result in current flow through the body diode from V_{OUT} to V_{IN} .

10.2 Typical Application

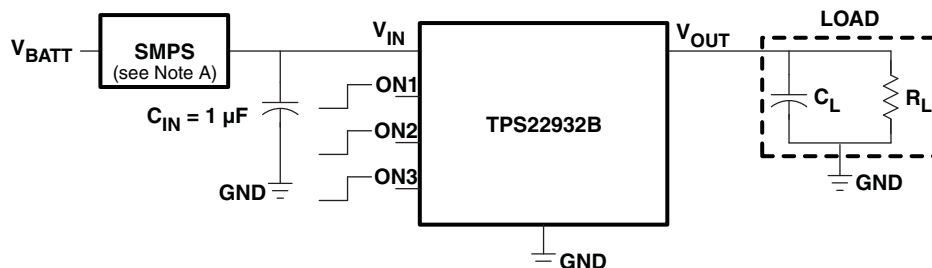

A. Switched-mode power supply

Figure 39. Typical Application

10.2.1 Design Requirements

For this example, follow the design parameters listed in [Table 3](#).

Table 3. Design Parameters

DESIGN PARAMETERS	EXAMPLE VALUE
V_{IN}	3.3 V
C_L	4.7 μ F
Maximum Acceptable Inrush Current	150 mA

10.2.2 Detailed Design Procedure

10.2.2.1 VIN to VOUT Voltage Drop

The VIN to VOUT voltage drop in the device is determined by the r_{ON} of the device and the load current. The r_{ON} of the device depends upon the VIN condition of the device. Refer to the r_{ON} specification of the device in the [Electrical Characteristics](#) table of this data sheet. When the r_{ON} of the device is determined based upon the VIN conditions, use [Equation 1](#) to calculate the VIN to VOUT voltage drop:

$$\Delta V = I_{LOAD} \times r_{ON}$$

where

- ΔV = Voltage drop from VIN to VOUT
- I_{LOAD} = Load current
- r_{ON} = ON-resistance of the device for a specific V_{IN}
- An appropriate I_{LOAD} must be chosen such that the I_{MAX} specification of the device is not violated. (1)

10.2.2.2 Managing Inrush Current

When the switch is enabled, the output capacitors must be charged up from 0-V to V_{IN} . This charge arrives in the form of inrush current. Inrush current can be calculated using the following equation:

$$\text{Inrush Current} = C \times \frac{dv}{dt}$$

where

- C = Output capacitance
- $\frac{dv}{dt}$ = Output slew rate (2)

The TPS22932B offers a very slow controlled rise time for minimizing inrush current. This device can be selected based upon the maximum acceptable slew rate which can be calculated using the design requirements and the inrush current equation. An output capacitance of 4.7 μF will be used because the amount of inrush increases with output capacitance:

$$150 \text{ mA} = 4.7 \mu\text{F} \times \frac{dv}{dt} \quad (3)$$

$$\frac{dv}{dt} = 31.9 \text{ V/ms} \quad (4)$$

To ensure an inrush current of less than 150 mA, a device with a slew rate less than 31.9 V/ms must be used.

The TPS22932B has a typical rise time of 145 μs at 3.3 V. This results in a slew rate of 22.8 V/ms which meets the requirement.

10.2.3 Application Curve

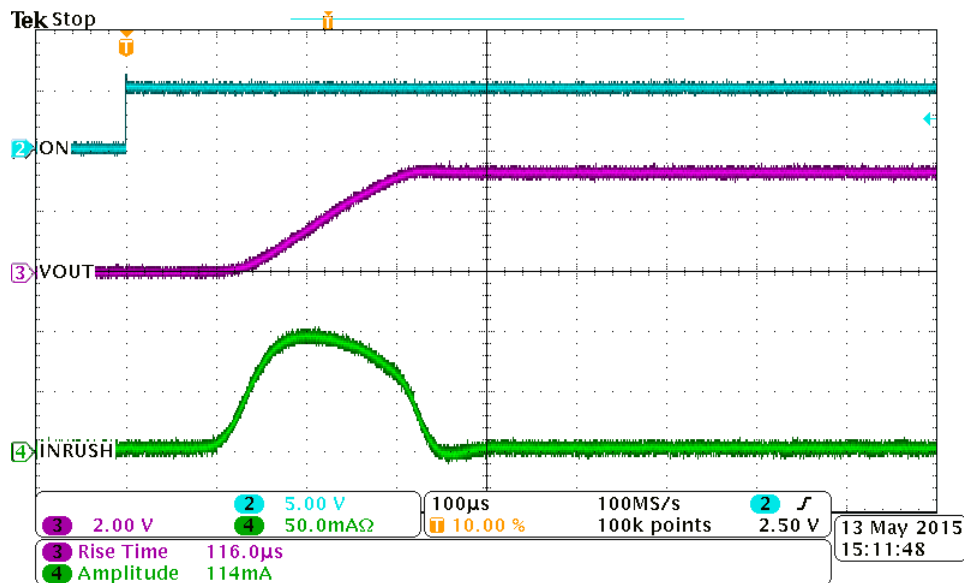

Figure 40. TPS22932B Inrush Current With 4.7-µF Output Capacitor

11 Power Supply Recommendations

The device is designed to operate with a V_{IN} range of 1.1 V to 3.6 V. This supply must be well regulated and placed as close to the device terminal as possible with the recommended 1-µF bypass capacitor. If the supply is located more than a few inches from the device terminals, additional bulk capacitance may be required in addition to the ceramic bypass capacitors. If additional bulk capacitance is required, an electrolytic, tantalum, or ceramic capacitor of 10 µF may be sufficient.

12 Layout

12.1 Layout Guidelines

For best performance, all traces should be as short as possible. To be most effective, the input and output capacitors should be placed close to the device to minimize the effects that parasitic trace inductances may have on normal and short-circuit operation. Using wide traces for V_{IN} , V_{OUT} , and GND will help minimize the parasitic electrical effects along with minimizing the case to ambient thermal impedance.

12.2 Layout Example

○ VIA to Power Ground Plane

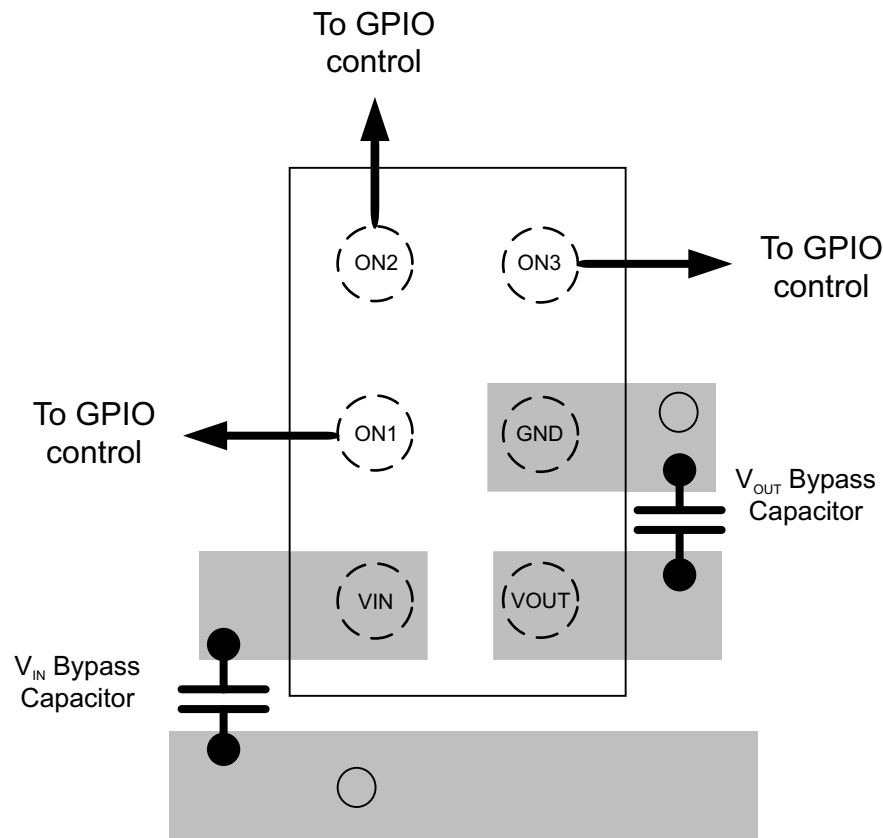

Figure 41. Layout Example

13 Device and Documentation Support

13.1 Community Resources

The following links connect to TI community resources. Linked contents are provided "AS IS" by the respective contributors. They do not constitute TI specifications and do not necessarily reflect TI's views; see TI's [Terms of Use](#).

TI E2E™ Online Community *TI's Engineer-to-Engineer (E2E) Community*. Created to foster collaboration among engineers. At e2e.ti.com, you can ask questions, share knowledge, explore ideas and help solve problems with fellow engineers.

Design Support *TI's Design Support* Quickly find helpful E2E forums along with design support tools and contact information for technical support.

13.2 Trademarks

E2E is a trademark of Texas Instruments.
All other trademarks are the property of their respective owners.

13.3 Electrostatic Discharge Caution



These devices have limited built-in ESD protection. The leads should be shorted together or the device placed in conductive foam during storage or handling to prevent electrostatic damage to the MOS gates.

13.4 Glossary

[SLYZ022](#) — *TI Glossary*.

This glossary lists and explains terms, acronyms, and definitions.

14 Mechanical, Packaging, and Orderable Information

The following pages include mechanical, packaging, and orderable information. This information is the most current data available for the designated devices. This data is subject to change without notice and revision of this document. For browser-based versions of this data sheet, refer to the left-hand navigation.

PACKAGING INFORMATION

Orderable Device	Status (1)	Package Type	Package Drawing	Pins	Package Qty	Eco Plan (2)	Lead finish/ Ball material (6)	MSL Peak Temp (3)	Op Temp (°C)	Device Marking (4/5)	Samples
TPS22932BYFPR	ACTIVE	DSBGA	YFP	6	3000	RoHS & Green	SNAGCU	Level-1-260C-UNLIM	-40 to 85	(483, 485)	Samples
TPS22932BYFPT	ACTIVE	DSBGA	YFP	6	250	RoHS & Green	SNAGCU	Level-1-260C-UNLIM	-40 to 85	(483, 485)	Samples

(1) The marketing status values are defined as follows:

ACTIVE: Product device recommended for new designs.

LIFEBUY: TI has announced that the device will be discontinued, and a lifetime-buy period is in effect.

NRND: Not recommended for new designs. Device is in production to support existing customers, but TI does not recommend using this part in a new design.

PREVIEW: Device has been announced but is not in production. Samples may or may not be available.

OBSOLETE: TI has discontinued the production of the device.

(2) **RoHS:** TI defines "RoHS" to mean semiconductor products that are compliant with the current EU RoHS requirements for all 10 RoHS substances, including the requirement that RoHS substance do not exceed 0.1% by weight in homogeneous materials. Where designed to be soldered at high temperatures, "RoHS" products are suitable for use in specified lead-free processes. TI may reference these types of products as "Pb-Free".

RoHS Exempt: TI defines "RoHS Exempt" to mean products that contain lead but are compliant with EU RoHS pursuant to a specific EU RoHS exemption.

Green: TI defines "Green" to mean the content of Chlorine (Cl) and Bromine (Br) based flame retardants meet JS709B low halogen requirements of <=1000ppm threshold. Antimony trioxide based flame retardants must also meet the <=1000ppm threshold requirement.

(3) MSL, Peak Temp. - The Moisture Sensitivity Level rating according to the JEDEC industry standard classifications, and peak solder temperature.

(4) There may be additional marking, which relates to the logo, the lot trace code information, or the environmental category on the device.

(5) Multiple Device Markings will be inside parentheses. Only one Device Marking contained in parentheses and separated by a "~" will appear on a device. If a line is indented then it is a continuation of the previous line and the two combined represent the entire Device Marking for that device.

(6) Lead finish/Ball material - Orderable Devices may have multiple material finish options. Finish options are separated by a vertical ruled line. Lead finish/Ball material values may wrap to two lines if the finish value exceeds the maximum column width.

Important Information and Disclaimer: The information provided on this page represents TI's knowledge and belief as of the date that it is provided. TI bases its knowledge and belief on information provided by third parties, and makes no representation or warranty as to the accuracy of such information. Efforts are underway to better integrate information from third parties. TI has taken and continues to take reasonable steps to provide representative and accurate information but may not have conducted destructive testing or chemical analysis on incoming materials and chemicals. TI and TI suppliers consider certain information to be proprietary, and thus CAS numbers and other limited information may not be available for release.

In no event shall TI's liability arising out of such information exceed the total purchase price of the TI part(s) at issue in this document sold by TI to Customer on an annual basis.

TAPE AND REEL INFORMATION



QUADRANT ASSIGNMENTS FOR PIN 1 ORIENTATION IN TAPE



*All dimensions are nominal

Device	Package Type	Package Drawing	Pins	SPQ	Reel Diameter (mm)	Reel Width W1 (mm)	A0 (mm)	B0 (mm)	K0 (mm)	P1 (mm)	W (mm)	Pin1 Quadrant
TPS22932BYFPR	DSBGA	YFP	6	3000	178.0	9.2	0.89	1.29	0.62	4.0	8.0	Q1
TPS22932BYFPT	DSBGA	YFP	6	250	178.0	9.2	0.89	1.29	0.62	4.0	8.0	Q1

TAPE AND REEL BOX DIMENSIONS

*All dimensions are nominal

Device	Package Type	Package Drawing	Pins	SPQ	Length (mm)	Width (mm)	Height (mm)
TPS22932BYFPR	DSBGA	YFP	6	3000	220.0	220.0	35.0
TPS22932BYFPT	DSBGA	YFP	6	250	220.0	220.0	35.0

YFP0006



PACKAGE OUTLINE

DSBGA - 0.5 mm max height

DIE SIZE BALL GRID ARRAY

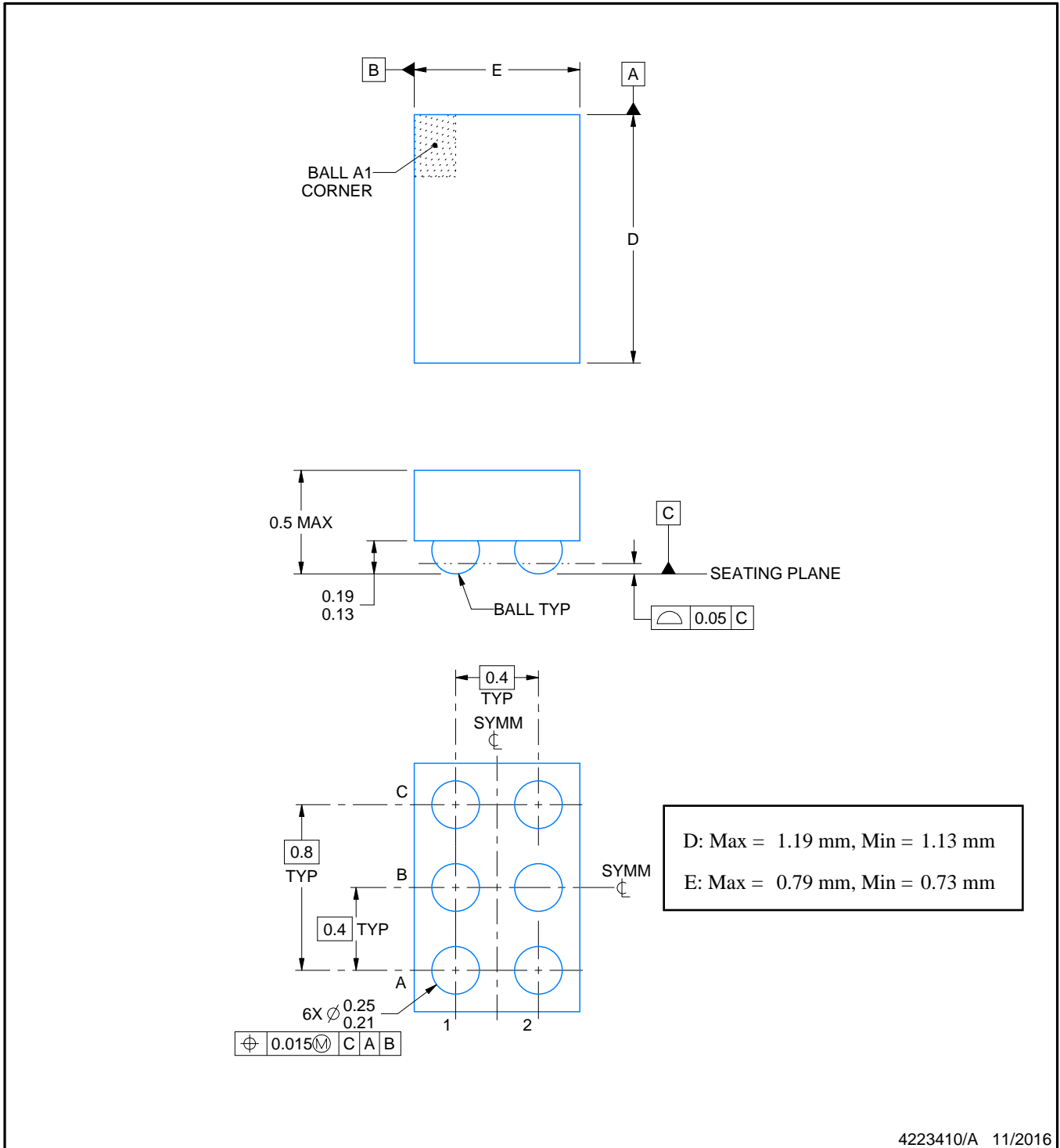

4223410/A 11/2016

NOTES:

1. All linear dimensions are in millimeters. Any dimensions in parenthesis are for reference only. Dimensioning and tolerancing per ASME Y14.5M.
2. This drawing is subject to change without notice.

EXAMPLE BOARD LAYOUT

YFP0006

DSBGA - 0.5 mm max height

DIE SIZE BALL GRID ARRAY

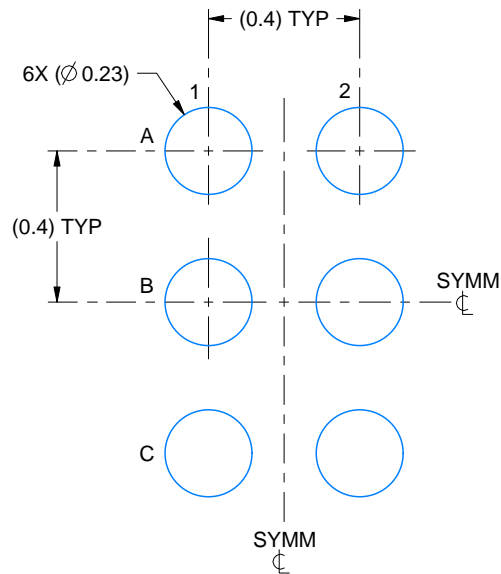

LAND PATTERN EXAMPLE
SCALE:50X

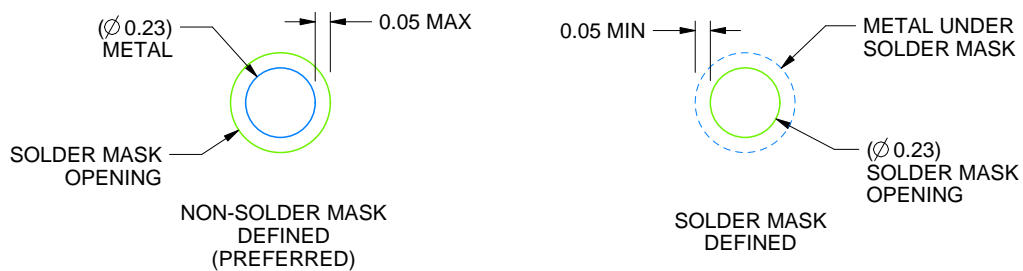

SOLDER MASK DETAILS
NOT TO SCALE

4223410/A 11/2016

NOTES: (continued)

- Final dimensions may vary due to manufacturing tolerance considerations and also routing constraints. For more information, see Texas Instruments literature number SNVA009 (www.ti.com/lit/snva009).

EXAMPLE STENCIL DESIGN

YFP0006

DSBGA - 0.5 mm max height

DIE SIZE BALL GRID ARRAY

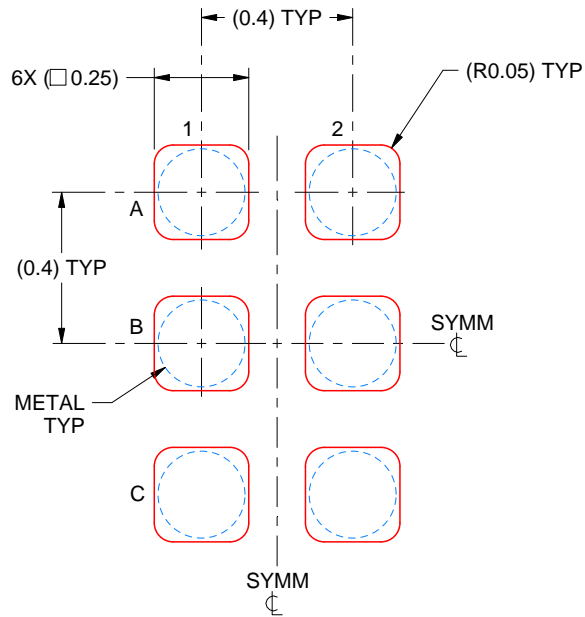

SOLDER PASTE EXAMPLE
BASED ON 0.1 mm THICK STENCIL
SCALE:50X

4223410/A 11/2016

NOTES: (continued)

4. Laser cutting apertures with trapezoidal walls and rounded corners may offer better paste release.

IMPORTANT NOTICE AND DISCLAIMER

TI PROVIDES TECHNICAL AND RELIABILITY DATA (INCLUDING DATA SHEETS), DESIGN RESOURCES (INCLUDING REFERENCE DESIGNS), APPLICATION OR OTHER DESIGN ADVICE, WEB TOOLS, SAFETY INFORMATION, AND OTHER RESOURCES "AS IS" AND WITH ALL FAULTS, AND DISCLAIMS ALL WARRANTIES, EXPRESS AND IMPLIED, INCLUDING WITHOUT LIMITATION ANY IMPLIED WARRANTIES OF MERCHANTABILITY, FITNESS FOR A PARTICULAR PURPOSE OR NON-INFRINGEMENT OF THIRD PARTY INTELLECTUAL PROPERTY RIGHTS.

These resources are intended for skilled developers designing with TI products. You are solely responsible for (1) selecting the appropriate TI products for your application, (2) designing, validating and testing your application, and (3) ensuring your application meets applicable standards, and any other safety, security, regulatory or other requirements.

These resources are subject to change without notice. TI grants you permission to use these resources only for development of an application that uses the TI products described in the resource. Other reproduction and display of these resources is prohibited. No license is granted to any other TI intellectual property right or to any third party intellectual property right. TI disclaims responsibility for, and you will fully indemnify TI and its representatives against, any claims, damages, costs, losses, and liabilities arising out of your use of these resources.

TI's products are provided subject to [TI's Terms of Sale](#) or other applicable terms available either on [ti.com](https://www.ti.com) or provided in conjunction with such TI products. TI's provision of these resources does not expand or otherwise alter TI's applicable warranties or warranty disclaimers for TI products.

TI objects to and rejects any additional or different terms you may have proposed.

Mailing Address: Texas Instruments, Post Office Box 655303, Dallas, Texas 75265
Copyright © 2023, Texas Instruments Incorporated