

## TPS22975 5.7V、6A、导通电阻为 16mΩ 的负载开关

### 1 特性

- 集成单通道负载开关
- 输入电压范围：0.6V 至  $V_{BIAS}$
- $V_{BIAS}$  电压范围：2.5V 至 5.7V
- 导通电阻 ( $R_{ON}$ )
  - $R_{ON} = 16m\Omega$  ( $V_{IN} = 0.6V$  到  $5.7V$ ,  $V_{BIAS} = 5.7V$  时的典型值)
- 6A 最大持续开关电流
- 低静态电流
  - $37\mu A$  ( $V_{IN} = V_{BIAS} = 5V$  时的典型值)
- 低控制输入阈值支持使用 1.2V、1.8V、2.5V、3.3V 逻辑器件
- 可配置的上升时间
- 热关断
- 快速输出放电 (QOD) (可选)
- 带有散热焊盘的小外形尺寸无引线 (SON) 8 引脚封装
- 经测试，静电放电 (ESD) 性能符合 JESD 22 规范
  - 2000V 人体模型 (HBM) 和 1000V 带电器件模型 (CDM)

### 2 应用

- Ultrabook™
- 笔记本电脑和上网本
- 平板电脑
- 消费类电子产品
- 机顶盒和家庭网关
- 电信系统
- 固态硬盘 (SSD)

简化电路原理图

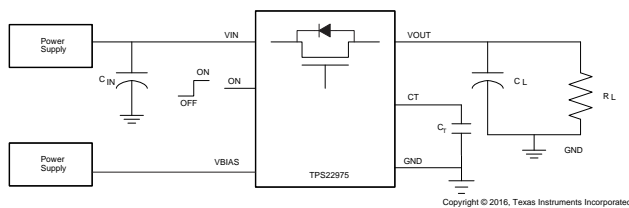

### 3 说明

TPS22975 产品系列包含两个器件：TPS22975 和 TPS22975N。每个器件都是一款单通道负载开关，可提供可配置的上升时间来尽量减小浪涌电流。此器件包括一个 N 通道金属氧化物半导体场效应晶体管 (MOSFET)，可在 0.6V 至 5.7V 的输入电压范围内运行并可支持 6A 的最大持续电流。此开关由一个开/关输入 (ON) 控制，此输入能够直接连接低电压控制信号。TPS22975 包含一个可选 230Ω 片上负载电阻，用于在此开关关断时进行快速输出放电。

TPS22975 采用小型，节省空间的 2mm × 2mm 8 引脚 SON 封装 (DSG)，集成的散热焊盘允许该器件产生较高的功率耗散。该器件在自然通风环境下的额定运行温度范围为 -40°C 至 +105°C。

器件信息(1)

器件型号	封装	封装尺寸 (标称值)
TPS22975 TPS22975N	WSON (8)	2.00mm x 2.00mm

(1) 要了解所有可用封装，请参阅数据表末尾的可订购产品附录。

导通电阻与输入电压间的关系

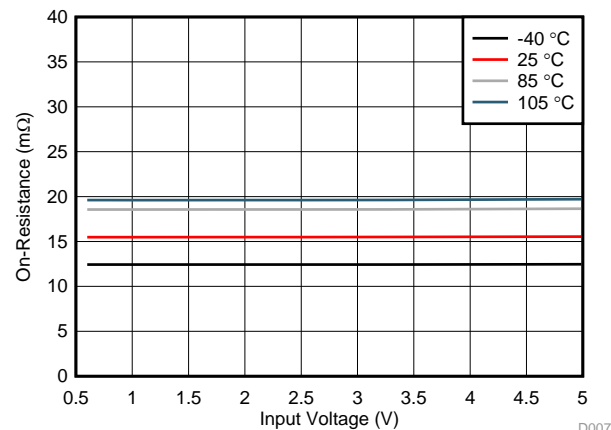

$V_{BIAS} = 5V$ ,  $I_{VOUT} = -200mA$

D007



## 目录

<b>1</b>	特性 .....	<b>1</b>	9.2	Functional Block Diagram .....	<b>14</b>
<b>2</b>	应用 .....	<b>1</b>	9.3	Feature Description .....	<b>15</b>
<b>3</b>	说明 .....	<b>1</b>	9.4	Device Functional Modes .....	<b>15</b>
<b>4</b>	修订历史记录 .....	<b>2</b>	<b>10</b>	<b>Application and Implementation</b> .....	<b>16</b>
<b>5</b>	<b>Device Comparison Table</b> .....	<b>3</b>	10.1	Application Information .....	<b>16</b>
<b>6</b>	<b>Pin Configuration and Functions</b> .....	<b>3</b>	10.2	Typical Application .....	<b>16</b>
<b>7</b>	<b>Specifications</b> .....	<b>4</b>	<b>11</b>	<b>Power Supply Recommendations</b> .....	<b>18</b>
7.1	Absolute Maximum Ratings .....	<b>4</b>	<b>12</b>	<b>Layout</b> .....	<b>19</b>
7.2	ESD Ratings .....	<b>4</b>	12.1	Layout Guidelines .....	<b>19</b>
7.3	Recommended Operating Conditions .....	<b>4</b>	12.2	Layout Example .....	<b>19</b>
7.4	Thermal Information .....	<b>5</b>	12.3	Thermal Considerations .....	<b>19</b>
7.5	Electrical Characteristics— $V_{BIAS} = 5\text{ V}$ .....	<b>5</b>	<b>13</b>	<b>器件和文档支持</b> .....	<b>20</b>
7.6	Electrical Characteristics— $V_{BIAS} = 2.5\text{ V}$ .....	<b>6</b>	13.1	器件支持 .....	<b>20</b>
7.7	Switching Characteristics .....	<b>7</b>	13.2	相关文档 .....	<b>20</b>
7.8	Typical DC Characteristics .....	<b>8</b>	13.3	接收文档更新通知 .....	<b>20</b>
7.9	Typical AC Characteristics .....	<b>10</b>	13.4	社区资源 .....	<b>20</b>
<b>8</b>	<b>Parameter Measurement Information</b> .....	<b>13</b>	13.5	商标 .....	<b>20</b>
<b>9</b>	<b>Detailed Description</b> .....	<b>14</b>	13.6	静电放电警告 .....	<b>20</b>
9.1	Overview .....	<b>14</b>	13.7	Glossary .....	<b>20</b>
			<b>14</b>	<b>机械、封装和可订购信息</b> .....	<b>20</b>

## 4 修订历史记录

Changes from Revision A (June 2016) to Revision B		Page
• Updated $V_{IH}$ in <i>Recommended Operating Conditions</i> .....		<b>4</b>

  

Changes from Original (May 2016) to Revision A		Page
• 器件状态，从产品预览改为量产数据 .....		<b>1</b>

## 5 Device Comparison Table

DEVICE	$R_{ON}$ AT $V_{IN} = V_{BIAS} = 5\text{ V}$ (TYPICAL)	QUICK-OUTPUT DISCHARGE	MAXIMUM OUTPUT CURRENT	ENABLE
TPS22975	16 m $\Omega$	Yes	6 A	Active high
TPS22975N	16 m $\Omega$	No	6 A	Active high

## 6 Pin Configuration and Functions

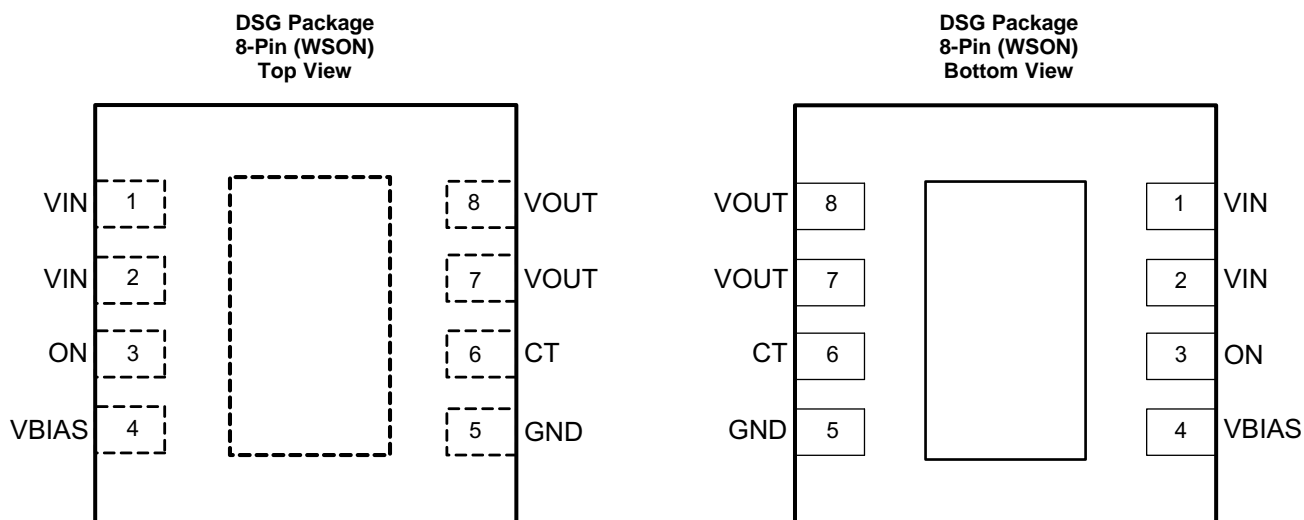

### Pin Functions

PIN		I/O	DESCRIPTION
NO.	NAME		
1	VIN	I	Switch input. Input bypass capacitor recommended for minimizing $V_{IN}$ dip. Must be connected to Pin 1 and Pin 2. See the <a href="#">Application and Implementation</a> section for more information
2			
3	ON	I	Active high switch control input. Do not leave floating
4	VBIAS	I	Bias voltage. Power supply to the device. Recommended voltage range for this pin is 2.5 V to 5.7 V. See the <a href="#">Application and Implementation</a> section for more information
5	GND	—	Device ground
6	CT	O	Switch slew rate control. Can be left floating. See the <a href="#">Adjustable Rise Time</a> section under <a href="#">Feature Description</a> for more information
7	VOUT	O	Switch output
8			
—	Thermal Pad	—	Thermal pad (exposed center pad) to alleviate thermal stress. Tie to GND. See the <a href="#">Layout Example</a> section for layout guidelines

## 7 Specifications

### 7.1 Absolute Maximum Ratings

Over operating free-air temperature range (unless otherwise noted)<sup>(1)</sup>

		MIN	MAX	UNIT
V <sub>IN</sub>	Input voltage	-0.3	6	V
V <sub>OUT</sub>	Output voltage	-0.3	6	V
V <sub>BIAS</sub>	Bias voltage	-0.3	6	V
V <sub>ON</sub>	On voltage	-0.3	6	V
I <sub>MAX</sub>	Maximum continuous switch current		6	A
I <sub>PLS</sub>	Maximum pulsed switch current, pulse < 300 μs, 2% duty cycle		8	A
T <sub>J</sub>	Maximum junction temperature		125	°C
T <sub>stg</sub>	Storage temperature	-65	150	°C

- (1) Stresses beyond those listed under *Absolute Maximum Ratings* may cause permanent damage to the device. These are stress ratings only, which do not imply functional operation of the device at these or any other conditions beyond those indicated under *Recommended Operating Conditions*. Exposure to absolute-maximum-rated conditions for extended periods may affect device reliability.

### 7.2 ESD Ratings

		VALUE	UNIT
V <sub>(ESD)</sub>	Electrostatic discharge	Human-body model (HBM), per ANSI/ESDA/JEDEC JS-001 <sup>(1)</sup>	±2000
		Charged-device model (CDM), per JEDEC specification JESD22-C101 <sup>(2)</sup>	±1000

- (1) JEDEC document JEP155 states that 500-V HBM allows safe manufacturing with a standard ESD control process.  
 (2) JEDEC document JEP157 states that 250-V CDM allows safe manufacturing with a standard ESD control process.

### 7.3 Recommended Operating Conditions

		MIN	MAX	UNIT
V <sub>IN</sub>	Input voltage	0.6	V <sub>BIAS</sub>	V
V <sub>BIAS</sub>	Bias voltage	2.5	5.7	V
V <sub>ON</sub>	ON voltage	0	5.7	V
V <sub>OUT</sub>	Output voltage		V <sub>IN</sub>	V
V <sub>IH</sub>	High-level input voltage, ON	V <sub>BIAS</sub> = 2.5 V to 5 V, T <sub>A</sub> < 85°C	1.05	5.7
		V <sub>BIAS</sub> = 2.5 V to 5 V, T <sub>A</sub> < 105°C	1.1	5.7
		V <sub>BIAS</sub> = 5 V to 5.7 V, T <sub>A</sub> < 105°C	1.2	5.7
V <sub>IL</sub>	Low-level input voltage, ON	0	0.5	V
C <sub>IN</sub>	Input capacitor	1 <sup>(1)</sup>		μF
T <sub>A</sub>	Operating free-air temperature <sup>(1)(2)</sup>	-40	105	°C

- (1) See the [Application Information](#) section.  
 (2) In applications where high power dissipation and/or poor package thermal resistance is present, the maximum ambient temperature may have to be derated and device lifetime may be affected. Maximum ambient temperature (T<sub>A(max)</sub>) is dependent on the maximum operating junction temperature (T<sub>J(max)</sub>), the maximum power dissipation of the device in the application (P<sub>D(max)</sub>), and the junction-to-ambient thermal resistance of the part-package in the application (θ<sub>JA</sub>), and can be approximated by the following equation: T<sub>A(max)</sub> = T<sub>J(max)</sub> - (θ<sub>JA</sub> × P<sub>D(max)</sub>).

## 7.4 Thermal Information

THERMAL METRIC <sup>(1)</sup>		TPS22975	
		DSG (WSON)	
		8 PINS	
			UNIT
$R_{\theta JA}$	Junction-to-ambient thermal resistance	74.8	°C/W
$R_{\theta JC(top)}$	Junction-to-case (top) thermal resistance	81	°C/W
$R_{\theta JB}$	Junction-to-board thermal resistance	44.7	°C/W
$\Psi_{JT}$	Junction-to-top characterization parameter	3.9	°C/W
$\Psi_{JB}$	Junction-to-board characterization parameter	45.1	°C/W
$R_{\theta JC(bot)}$	Junction-to-case (bottom) thermal resistance	16.4	°C/W

(1) For more information about traditional and new thermal metrics, see the [Semiconductor and IC Package Thermal Metrics](#) application report.

## 7.5 Electrical Characteristics— $V_{BIAS} = 5\text{ V}$

Unless otherwise noted, the specifications in the following table applies where  $V_{BIAS} = 5\text{ V}$ . Typical values are for  $T_A = 25\text{ °C}$ .

PARAMETER		TEST CONDITIONS		$T_A$	MIN	TYP	MAX	UNIT
<b>POWER SUPPLIES AND CURRENTS</b>								
$I_Q, V_{BIAS}$	$V_{BIAS}$ quiescent current	$I_{OUT} = 0\text{ A}$ , $V_{IN} = V_{ON} = 5\text{ V}$		-40°C to +105°C		37	45	μA
$I_{SD}, V_{BIAS}$	$V_{BIAS}$ shutdown current	$V_{ON} = V_{OUT} = 0\text{ V}$		-40°C to +105°C			2.3	μA
$I_{SD}, V_{IN}$	$V_{IN}$ off-state supply current	$V_{ON} = V_{OUT} = 0\text{ V}$	$V_{IN} = 5\text{ V}$	-40°C to +85°C		0.005	5	μA
				-40°C to +105°C			10	
			$V_{IN} = 3.3\text{ V}$	-40°C to +85°C		0.002	1.5	
				-40°C to +105°C			3.5	
			$V_{IN} = 1.8\text{ V}$	-40°C to +85°C		0.002	1	
				-40°C to +105°C			2	
$V_{IN} = 0.6\text{ V}$	-40°C to +85°C		0.001	0.5				
	-40°C to +105°C			1				
$I_{ON}$	On-pin input leakage current	$V_{ON} = 5.5\text{ V}$		-40°C to +105°C			0.1	μA
<b>RESISTANCE CHARACTERISTICS</b>								
$R_{ON}$	On-resistance	$I_{OUT} = -200\text{ mA}$	$V_{IN} = 5\text{ V}$	25°C		16	19	mΩ
				-40°C to +85°C			23	
				-40°C to +105°C			25	
			$V_{IN} = 3.3\text{ V}$	25°C		16	19	
				-40°C to +85°C			23	
				-40°C to +105°C			25	
			$V_{IN} = 1.8\text{ V}$	25°C		16	19	
				-40°C to +85°C			23	
				-40°C to +105°C			25	
			$V_{IN} = 1.5\text{ V}$	25°C		16	19	
				-40°C to +85°C			23	
				-40°C to +105°C			25	
			$V_{IN} = 1.05\text{ V}$	25°C		16	19	
				-40°C to +85°C			23	
				-40°C to +105°C			25	
			$V_{IN} = 0.6\text{ V}$	25°C		16	19	
-40°C to +85°C				23				
-40°C to +105°C				25				
$V_{ON, HYS}$	On-pin hysteresis	$V_{IN} = 5\text{ V}$		25°C		120		mV
$R_{PD}^{(1)}$	Output pulldown resistance	$V_{IN} = 5\text{ V}$ , $V_{ON} = 0\text{ V}$		-40°C to +105°C		230	300	Ω
$T_{SD}$	Thermal shutdown	Junction temperature rising				160		°C
$T_{SD, HYS}$	Thermal shutdown hysteresis	Junction temperature falling				20		°C

(1) TPS22975 only

### 7.6 Electrical Characteristics— $V_{BIAS} = 2.5\text{ V}$

Unless otherwise noted, the specifications in the following table applies where  $V_{BIAS} = 2.5\text{ V}$ . Typical values are for  $T_A = 25\text{ }^\circ\text{C}$ .

PARAMETER		TEST CONDITIONS	$T_A$	MIN	TYP	MAX	UNIT
<b>POWER SUPPLIES AND CURRENTS</b>							
$I_{Q, VBIAS}$	$V_{BIAS}$ quiescent current	$I_{OUT} = 0\text{ mA}$ , $V_{IN} = V_{ON} = 2.5\text{ V}$	$-40^\circ\text{C}$ to $+105^\circ\text{C}$		14	20	$\mu\text{A}$
$I_{SD, VBIAS}$	$V_{BIAS}$ shutdown current	$V_{ON} = V_{OUT} = 0\text{ V}$	$-40^\circ\text{C}$ to $+105^\circ\text{C}$			1	$\mu\text{A}$
$I_{SD, VIN}$	$V_{IN}$ off-state supply current	$V_{ON} = V_{OUT} = 0\text{ V}$	$V_{IN} = 2.5\text{ V}$	$-40^\circ\text{C}$ to $+85^\circ\text{C}$	0.005	1.3	$\mu\text{A}$
				$-40^\circ\text{C}$ to $+105^\circ\text{C}$		2.6	
			$V_{IN} = 1.8\text{ V}$	$-40^\circ\text{C}$ to $+85^\circ\text{C}$	0.002	1	
				$-40^\circ\text{C}$ to $+105^\circ\text{C}$		2	
			$V_{IN} = 1.05\text{ V}$	$-40^\circ\text{C}$ to $+85^\circ\text{C}$	0.002	0.8	
				$-40^\circ\text{C}$ to $+105^\circ\text{C}$		1.5	
$V_{IN} = 0.6\text{ V}$	$-40^\circ\text{C}$ to $+85^\circ\text{C}$	0.001	0.5				
	$-40^\circ\text{C}$ to $+105^\circ\text{C}$		1				
$I_{ON}$	On-pin input leakage current	$V_{ON} = 5.5\text{ V}$	$-40^\circ\text{C}$ to $+105^\circ\text{C}$			0.1	$\mu\text{A}$
<b>RESISTANCE CHARACTERISTICS</b>							
$R_{ON}$	On-resistance	$I_{OUT} = -200\text{ mA}$	$V_{IN} = 2.5\text{ V}$	$25^\circ\text{C}$	20	26	$\text{m}\Omega$
				$-40^\circ\text{C}$ to $+85^\circ\text{C}$		32	
				$-40^\circ\text{C}$ to $+105^\circ\text{C}$		34	
			$V_{IN} = 1.8\text{ V}$	$25^\circ\text{C}$	18	23	
				$-40^\circ\text{C}$ to $+85^\circ\text{C}$		29	
				$-40^\circ\text{C}$ to $+105^\circ\text{C}$		31	
			$V_{IN} = 1.5\text{ V}$	$25^\circ\text{C}$	18	22	
				$-40^\circ\text{C}$ to $+85^\circ\text{C}$		28	
				$-40^\circ\text{C}$ to $+105^\circ\text{C}$		30	
			$V_{IN} = 1.2\text{ V}$	$25^\circ\text{C}$	17	22	
				$-40^\circ\text{C}$ to $+85^\circ\text{C}$		27	
				$-40^\circ\text{C}$ to $+105^\circ\text{C}$		29	
			$V_{IN} = 0.6\text{ V}$	$25^\circ\text{C}$	17	21	
				$-40^\circ\text{C}$ to $+85^\circ\text{C}$		26	
				$-40^\circ\text{C}$ to $+105^\circ\text{C}$		27	
$V_{ON, HYS}$	On-pin hysteresis	$V_{IN} = 2.5\text{ V}$	$25^\circ\text{C}$		85		$\text{mV}$
$R_{PD}^{(1)}$	Output pulldown resistance	$V_{IN} = 2.5\text{ V}$ , $V_{ON} = 0\text{ V}$	$-40^\circ\text{C}$ to $+105^\circ\text{C}$		230	330	$\Omega$
$T_{SD}$	Thermal shutdown	Junction temperature rising			160		$^\circ\text{C}$
$T_{SD, HYS}$	Thermal shutdown hysteresis	Junction temperature falling			20		$^\circ\text{C}$

(1) TPS22975 only

## 7.7 Switching Characteristics

PARAMETER		TEST CONDITION	MIN	TYP	MAX	UNIT
<b><math>V_{IN} = V_{BIAS} = 5\text{ V}</math>, <math>T_A = 25^\circ\text{C}</math> (unless otherwise noted)</b>						
$t_{ON}$	Turnon time	$R_L = 10\ \Omega$ , $C_L = 0.1\ \mu\text{F}$ , $C_{IN} = 1\ \mu\text{F}$ , $C_T = 1000\ \text{pF}$ , $V_{ON} = 5\ \text{V}$		1450		$\mu\text{s}$
$t_{OFF}$	Turnoff time	$R_L = 10\ \Omega$ , $C_L = 0.1\ \mu\text{F}$ , $C_{IN} = 1\ \mu\text{F}$ , $C_T = 1000\ \text{pF}$ , $V_{ON} = 5\ \text{V}$		2		
$t_R$	$V_{OUT}$ rise time	$R_L = 10\ \Omega$ , $C_L = 0.1\ \mu\text{F}$ , $C_{IN} = 1\ \mu\text{F}$ , $C_T = 1000\ \text{pF}$ , $V_{ON} = 5\ \text{V}$		1750		
$t_F$	$V_{OUT}$ fall time	$R_L = 10\ \Omega$ , $C_L = 0.1\ \mu\text{F}$ , $C_{IN} = 1\ \mu\text{F}$ , $C_T = 1000\ \text{pF}$ , $V_{ON} = 5\ \text{V}$		2		
$t_D$	ON delay time	$R_L = 10\ \Omega$ , $C_L = 0.1\ \mu\text{F}$ , $C_{IN} = 1\ \mu\text{F}$ , $C_T = 1000\ \text{pF}$ , $V_{ON} = 5\ \text{V}$		600		
<b><math>V_{IN} = 0.6\ \text{V}</math>, <math>V_{BIAS} = 5\ \text{V}</math>, <math>T_A = 25^\circ\text{C}</math> (unless otherwise noted)</b>						
$t_{ON}$	Turnon time	$R_L = 10\ \Omega$ , $C_L = 0.1\ \mu\text{F}$ , $C_{IN} = 1\ \mu\text{F}$ , $C_T = 1000\ \text{pF}$ , $V_{ON} = 5\ \text{V}$		620		$\mu\text{s}$
$t_{OFF}$	Turnoff time	$R_L = 10\ \Omega$ , $C_L = 0.1\ \mu\text{F}$ , $C_{IN} = 1\ \mu\text{F}$ , $C_T = 1000\ \text{pF}$ , $V_{ON} = 5\ \text{V}$		2		
$t_R$	$V_{OUT}$ rise time	$R_L = 10\ \Omega$ , $C_L = 0.1\ \mu\text{F}$ , $C_{IN} = 1\ \mu\text{F}$ , $C_T = 1000\ \text{pF}$ , $V_{ON} = 5\ \text{V}$		280		
$t_F$	$V_{OUT}$ fall time	$R_L = 10\ \Omega$ , $C_L = 0.1\ \mu\text{F}$ , $C_{IN} = 1\ \mu\text{F}$ , $C_T = 1000\ \text{pF}$ , $V_{ON} = 5\ \text{V}$		2		
$t_D$	ON delay time	$R_L = 10\ \Omega$ , $C_L = 0.1\ \mu\text{F}$ , $C_{IN} = 1\ \mu\text{F}$ , $C_T = 1000\ \text{pF}$ , $V_{ON} = 5\ \text{V}$		485		
<b><math>V_{IN} = V_{BIAS} = 2.5\ \text{V}</math>, <math>T_A = 25^\circ\text{C}</math> (unless otherwise noted)</b>						
$t_{ON}$	Turnon time	$R_L = 10\ \Omega$ , $C_L = 0.1\ \mu\text{F}$ , $C_{IN} = 1\ \mu\text{F}$ , $C_T = 1000\ \text{pF}$ , $V_{ON} = 5\ \text{V}$		2180		$\mu\text{s}$
$t_{OFF}$	Turnoff time	$R_L = 10\ \Omega$ , $C_L = 0.1\ \mu\text{F}$ , $C_{IN} = 1\ \mu\text{F}$ , $C_T = 1000\ \text{pF}$ , $V_{ON} = 5\ \text{V}$		2		
$t_R$	$V_{OUT}$ rise time	$R_L = 10\ \Omega$ , $C_L = 0.1\ \mu\text{F}$ , $C_{IN} = 1\ \mu\text{F}$ , $C_T = 1000\ \text{pF}$ , $V_{ON} = 5\ \text{V}$		2150		
$t_F$	$V_{OUT}$ fall time	$R_L = 10\ \Omega$ , $C_L = 0.1\ \mu\text{F}$ , $C_{IN} = 1\ \mu\text{F}$ , $C_T = 1000\ \text{pF}$ , $V_{ON} = 5\ \text{V}$		2		
$t_D$	ON delay time	$R_L = 10\ \Omega$ , $C_L = 0.1\ \mu\text{F}$ , $C_{IN} = 1\ \mu\text{F}$ , $C_T = 1000\ \text{pF}$ , $V_{ON} = 5\ \text{V}$		1120		
<b><math>V_{IN} = 0.6\ \text{V}</math>, <math>V_{BIAS} = 2.5\ \text{V}</math>, <math>T_A = 25^\circ\text{C}</math> (unless otherwise noted)</b>						
$t_{ON}$	Turnon time	$R_L = 10\ \Omega$ , $C_L = 0.1\ \mu\text{F}$ , $C_{IN} = 1\ \mu\text{F}$ , $C_T = 1000\ \text{pF}$ , $V_{ON} = 5\ \text{V}$		1315		$\mu\text{s}$
$t_{OFF}$	Turnoff time	$R_L = 10\ \Omega$ , $C_L = 0.1\ \mu\text{F}$ , $C_{IN} = 1\ \mu\text{F}$ , $C_T = 1000\ \text{pF}$ , $V_{ON} = 5\ \text{V}$		3		
$t_R$	$V_{OUT}$ rise time	$R_L = 10\ \Omega$ , $C_L = 0.1\ \mu\text{F}$ , $C_{IN} = 1\ \mu\text{F}$ , $C_T = 1000\ \text{pF}$ , $V_{ON} = 5\ \text{V}$		650		
$t_F$	$V_{OUT}$ fall time	$R_L = 10\ \Omega$ , $C_L = 0.1\ \mu\text{F}$ , $C_{IN} = 1\ \mu\text{F}$ , $C_T = 1000\ \text{pF}$ , $V_{ON} = 5\ \text{V}$		2		
$t_D$	ON delay time	$R_L = 10\ \Omega$ , $C_L = 0.1\ \mu\text{F}$ , $C_{IN} = 1\ \mu\text{F}$ , $C_T = 1000\ \text{pF}$ , $V_{ON} = 5\ \text{V}$		975		

### 7.8 Typical DC Characteristics

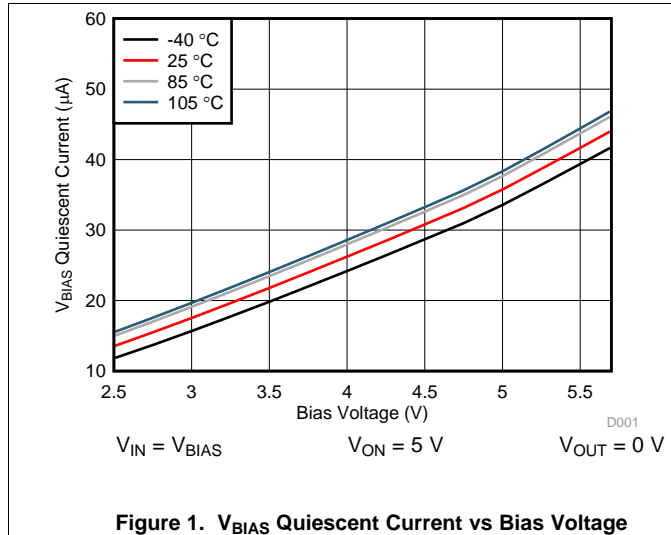

Figure 1.  $V_{BIAS}$  Quiescent Current vs Bias Voltage

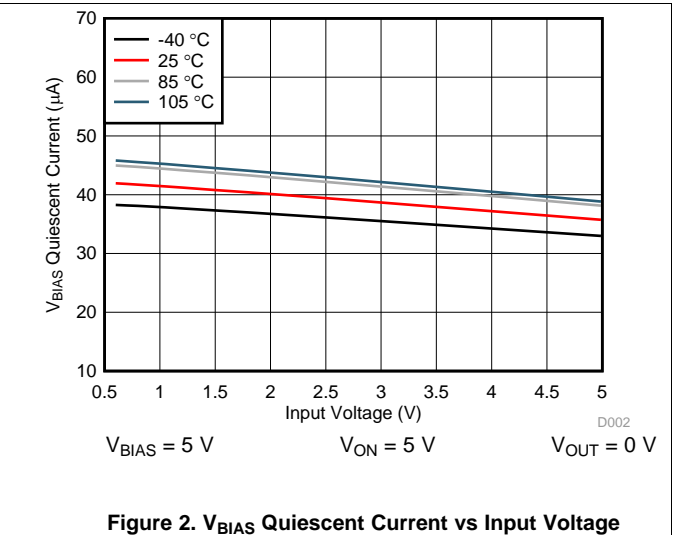

Figure 2.  $V_{BIAS}$  Quiescent Current vs Input Voltage

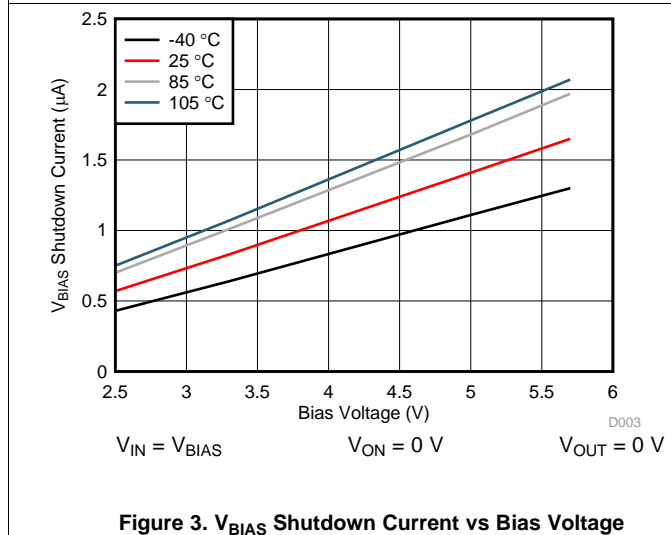

Figure 3.  $V_{BIAS}$  Shutdown Current vs Bias Voltage

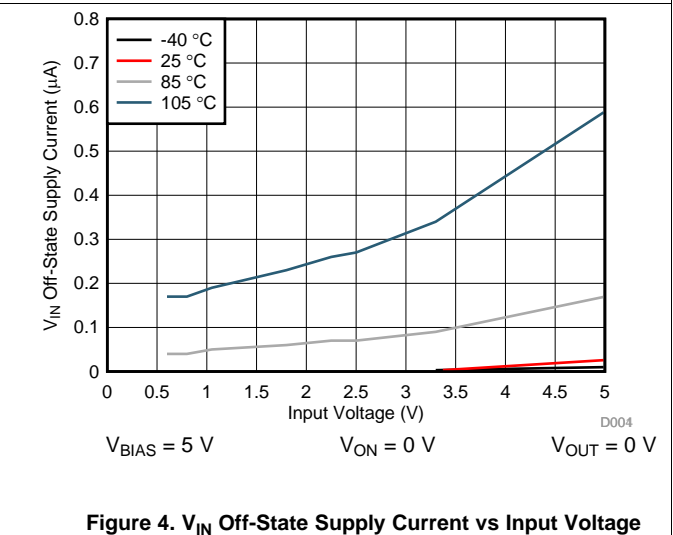

Figure 4.  $V_{IN}$  Off-State Supply Current vs Input Voltage

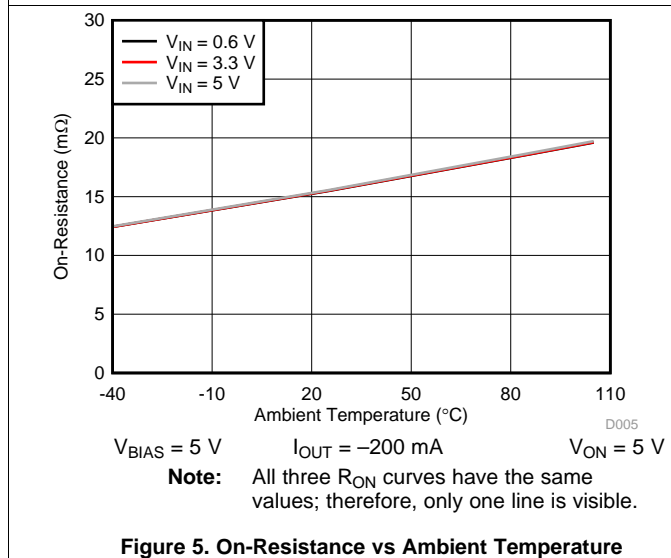

Figure 5. On-Resistance vs Ambient Temperature

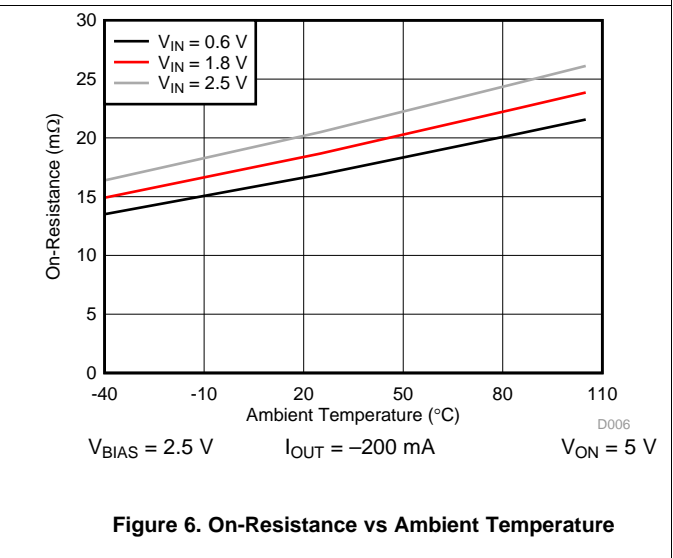
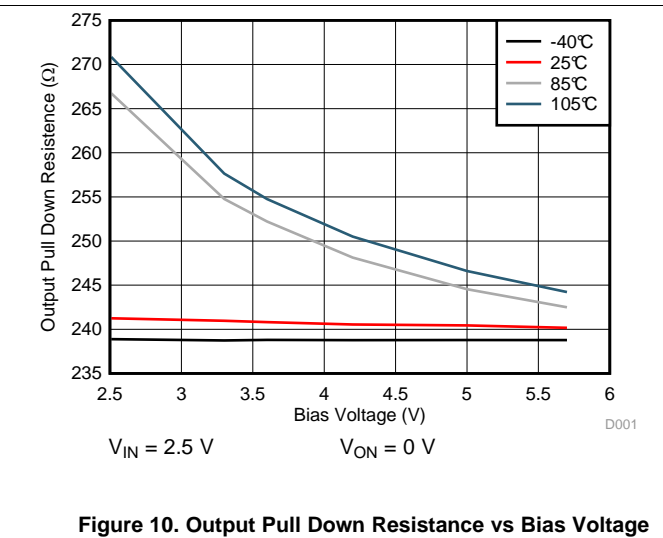
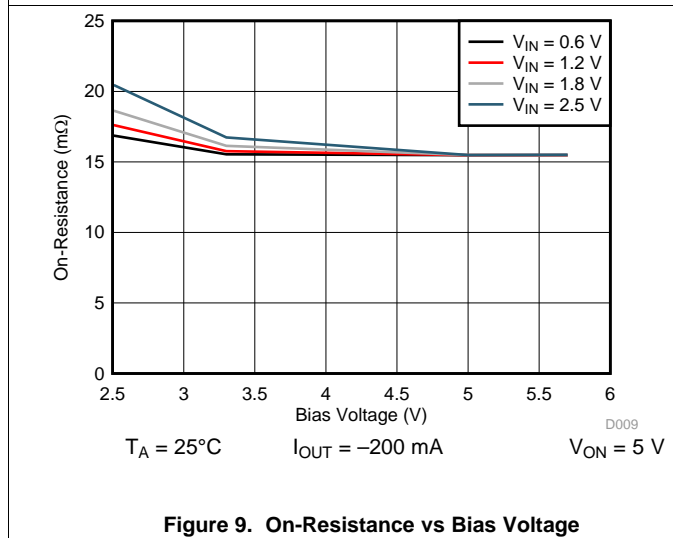
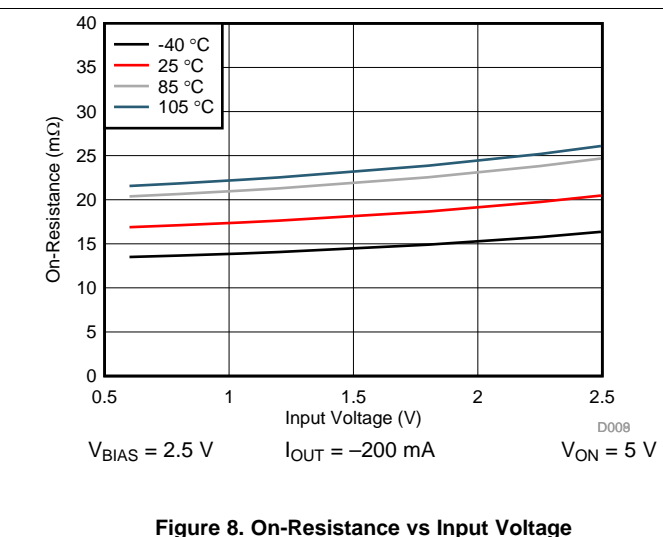
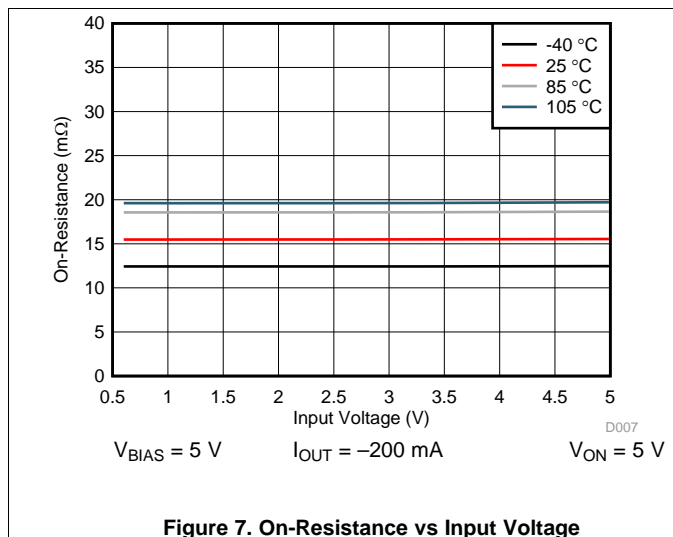

Figure 6. On-Resistance vs Ambient Temperature



Typical DC Characteristics (continued)



### 7.9 Typical AC Characteristics

$T_A = 25^\circ\text{C}$ ,  $C_T = 1000\text{ pF}$ ,  $C_{IN} = 1\text{ }\mu\text{F}$ ,  $C_L = 0.1\text{ }\mu\text{F}$ ,  $R_L = 10\text{ }\Omega$

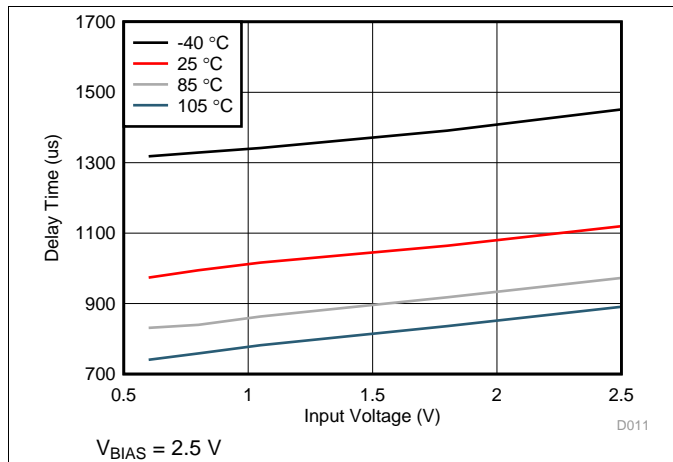

Figure 11. Delay Time vs Input Voltage

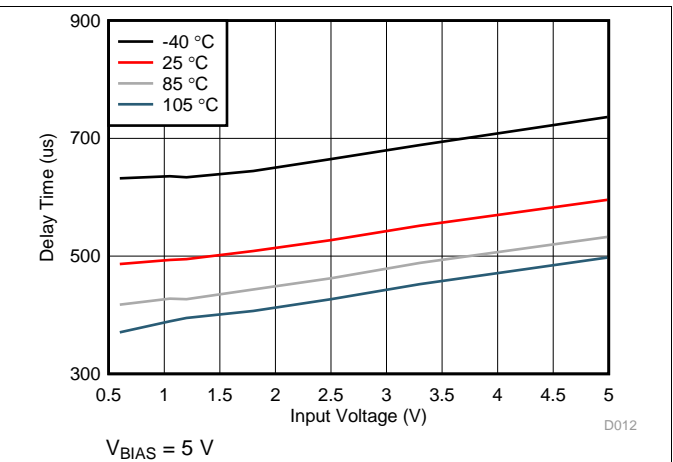

Figure 12. Delay Time vs Input Voltage

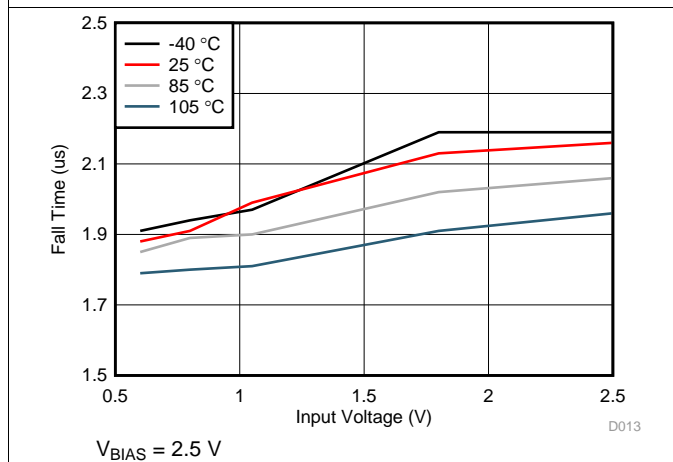

Figure 13. Fall Time vs Input Voltage

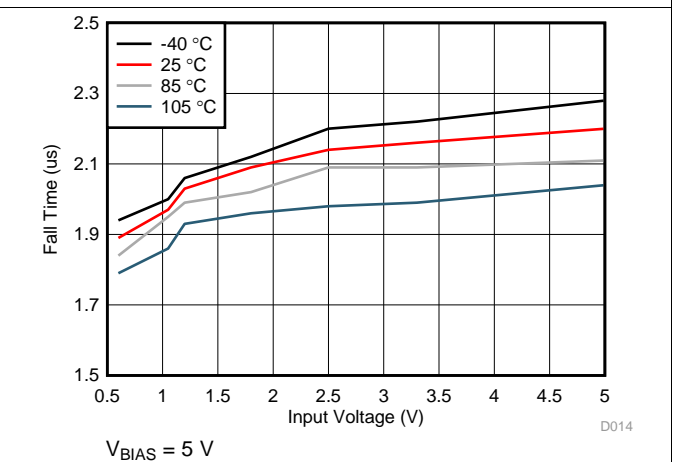

Figure 14. Fall Time vs Input Voltage

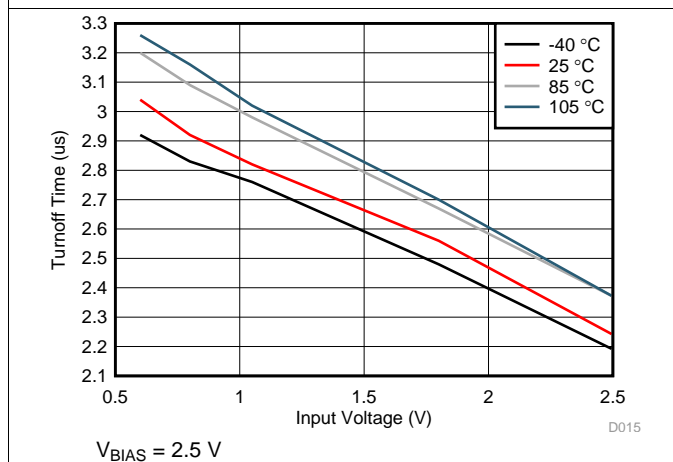

Figure 15. Turnoff Time vs Input Voltage

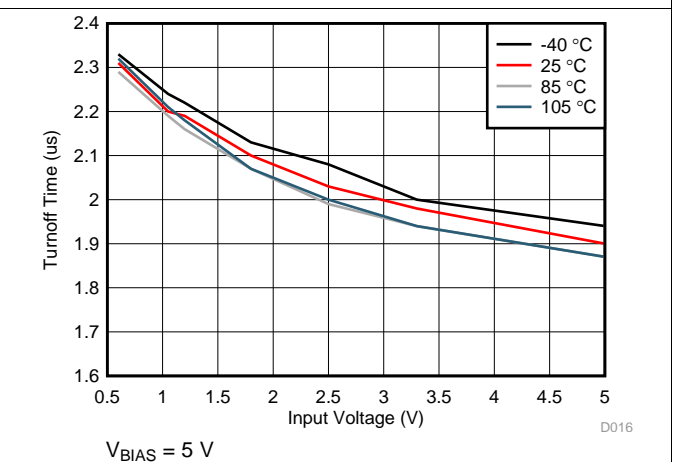

Figure 16. Turnoff Time vs Input Voltage

Typical AC Characteristics (continued)

$T_A = 25^\circ\text{C}$ ,  $C_T = 1000\text{ pF}$ ,  $C_{IN} = 1\text{ }\mu\text{F}$ ,  $C_L = 0.1\text{ }\mu\text{F}$ ,  $R_L = 10\text{ }\Omega$

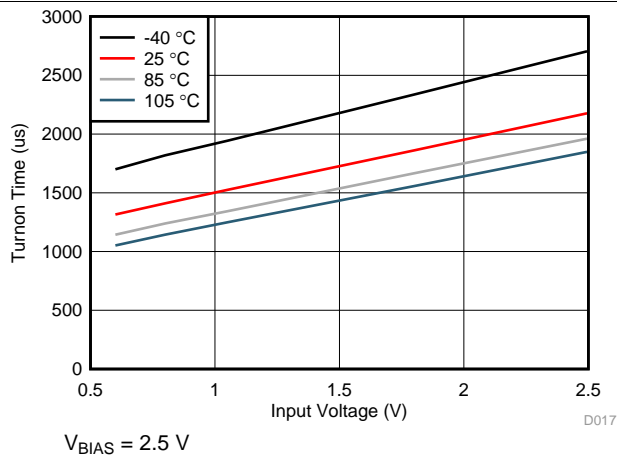

Figure 17. Turnon Time vs Input Voltage

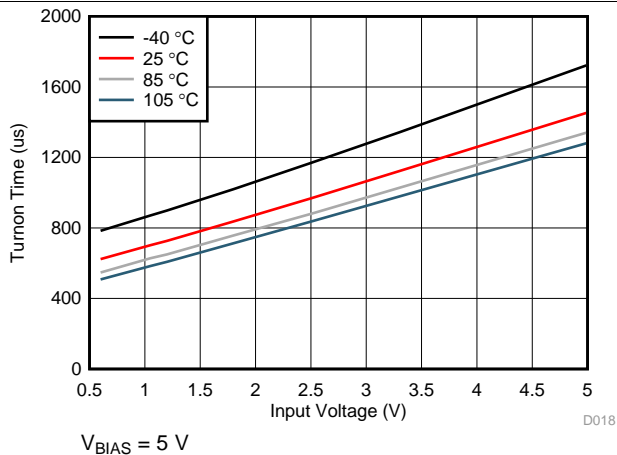

Figure 18. Turnon Time vs Input Voltage

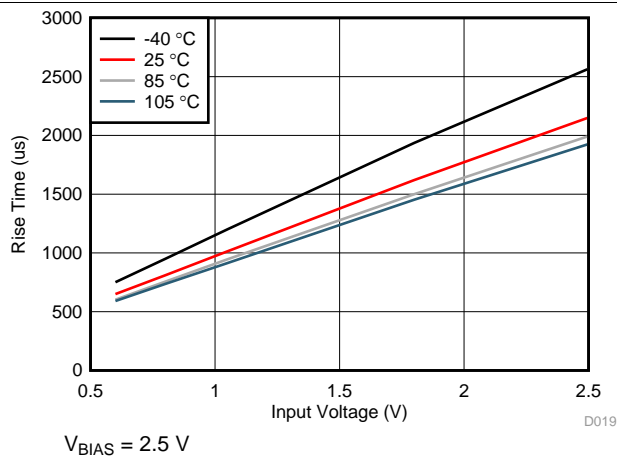

Figure 19. Rise Time vs Input Voltage

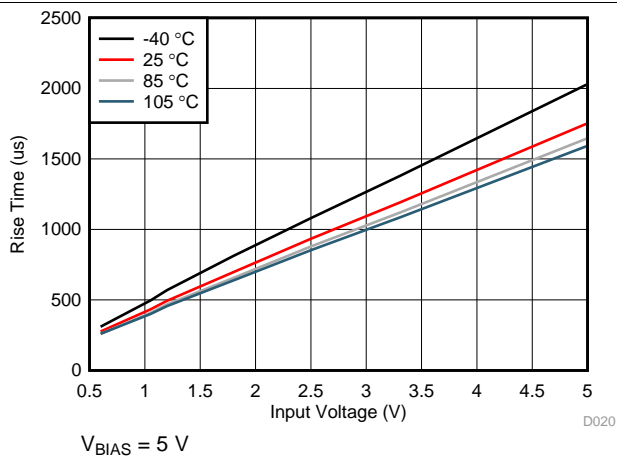

Figure 20. Rise Time vs Input Voltage

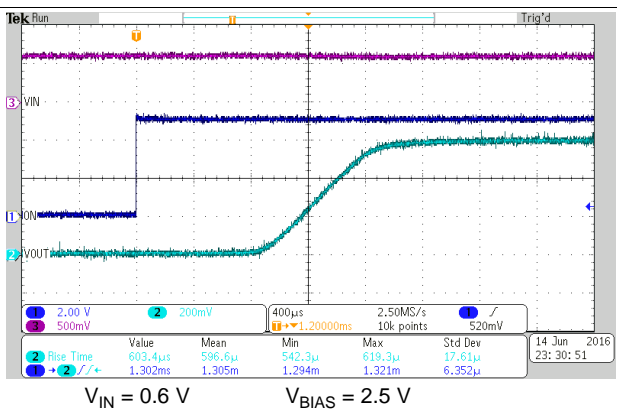

Figure 21. Turnon Response Time

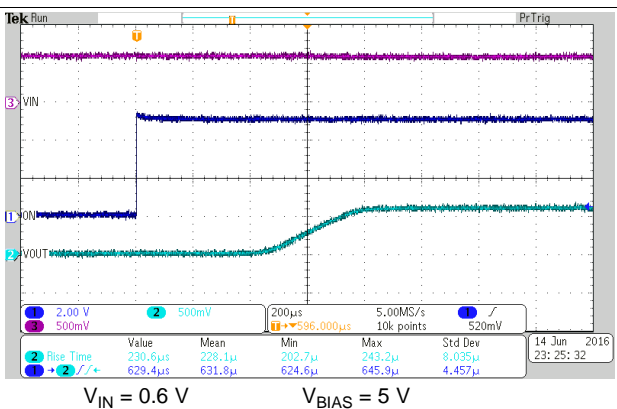

Figure 22. Turnon Response Time

Typical AC Characteristics (continued)

T<sub>A</sub> = 25°C, C<sub>T</sub> = 1000 pF, C<sub>IN</sub> = 1 μF, C<sub>L</sub> = 0.1 μF, R<sub>L</sub> = 10 Ω

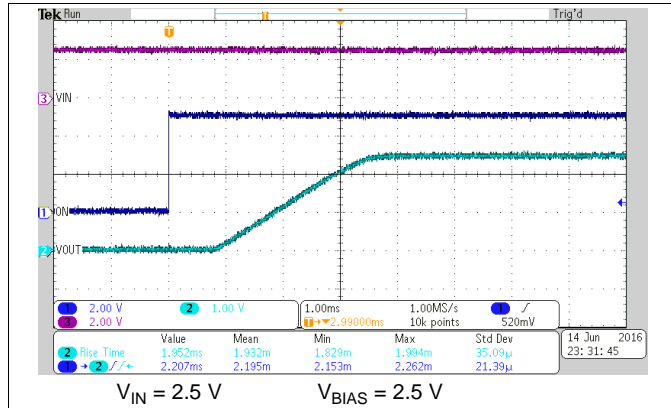

Figure 23. Turnon Response Time

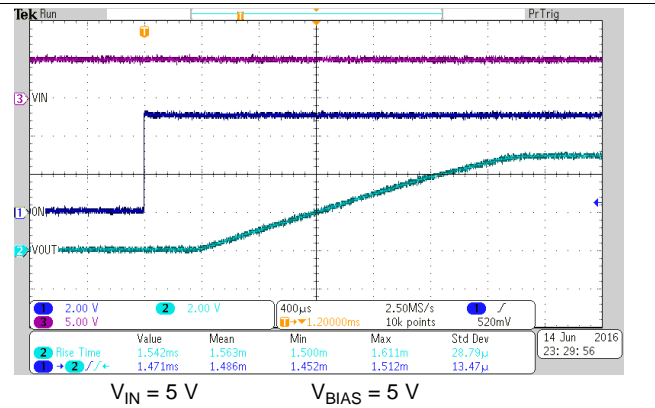

Figure 24. Turnon Response Time

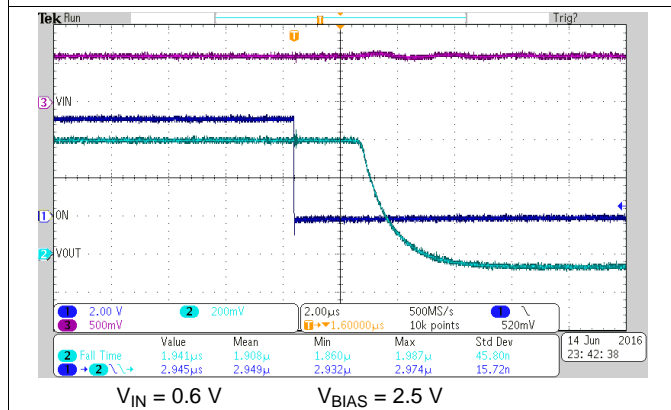

Figure 25. Turnoff Response Time

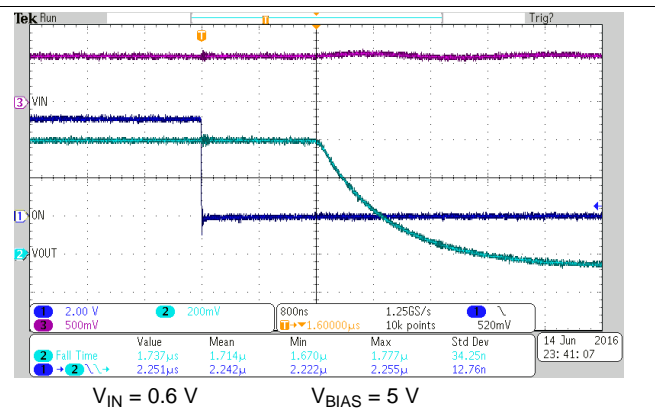

Figure 26. Turnoff Response Time

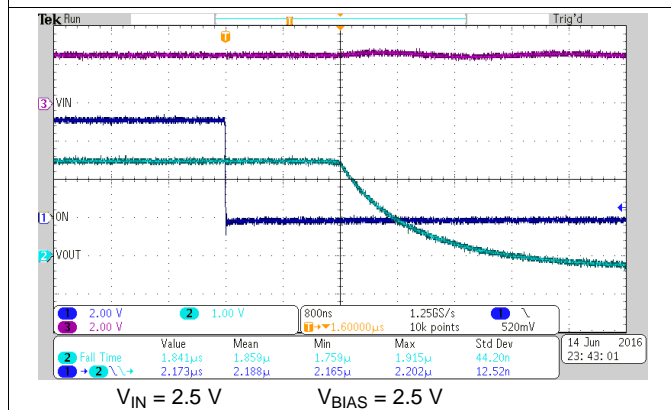

Figure 27. Turnoff Response Time

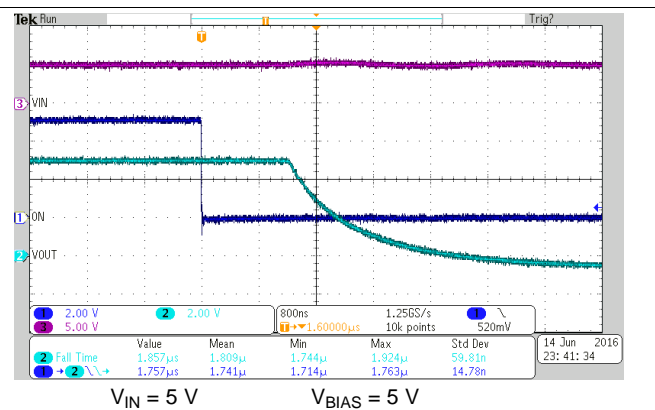
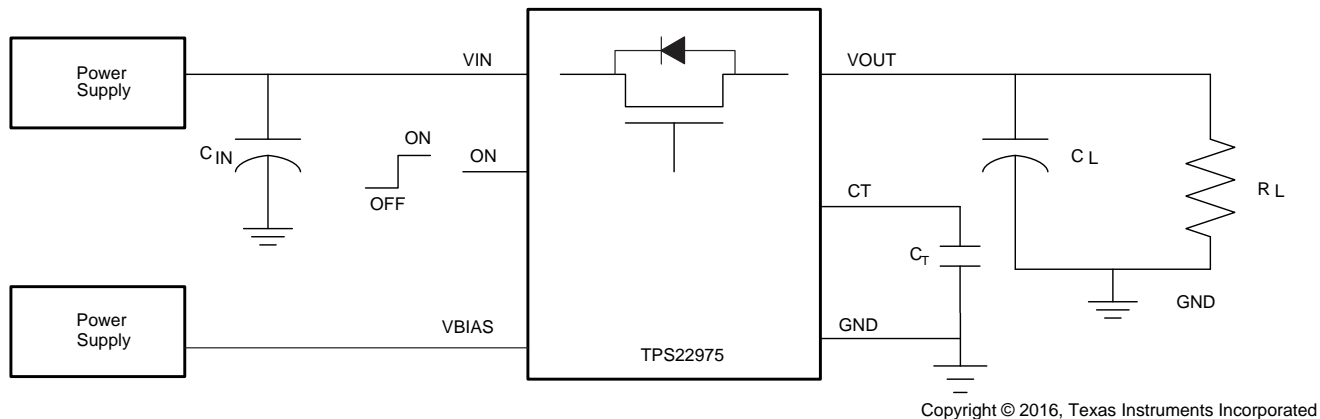

Figure 28. Turnoff Response Time

## 8 Parameter Measurement Information



- A. Rise and fall times of the control signal are 100 ns.
- B. Turnoff times and fall times are dependent on the time constant at the load. For the TPS22975, the internal pull-down resistance  $R_{PD}$  is enabled when the switch is disabled. The time constant is  $(R_{PD} \parallel R_L) \times C_L$ .

**Figure 29. Test Circuit**

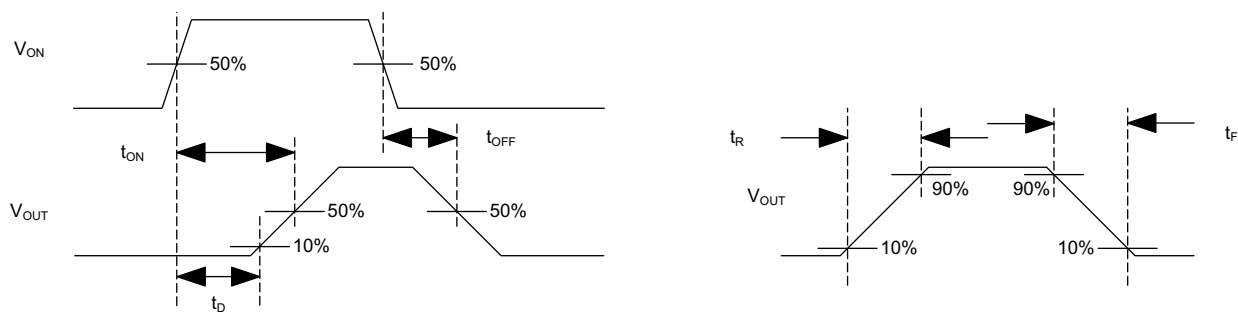

**Figure 30.  $t_{ON}$  and  $t_{OFF}$  Waveforms**

## 9 Detailed Description

### 9.1 Overview

The TPS22975 device is a single-channel, 6-A load switch in an 8-pin SON package. To reduce the voltage drop in high current rails, the device implements an N-channel MOSFET. The device has a configurable slew rate for applications that require a specific rise-time.

The device prevents downstream circuits from pulling high standby current from the supply by limiting the leakage current of the device when it is disabled. The integrated control logic, driver, power supply, and output discharge FET eliminates the need for any external components, which reduces solution size and bill of materials (BOM) count.

### 9.2 Functional Block Diagram

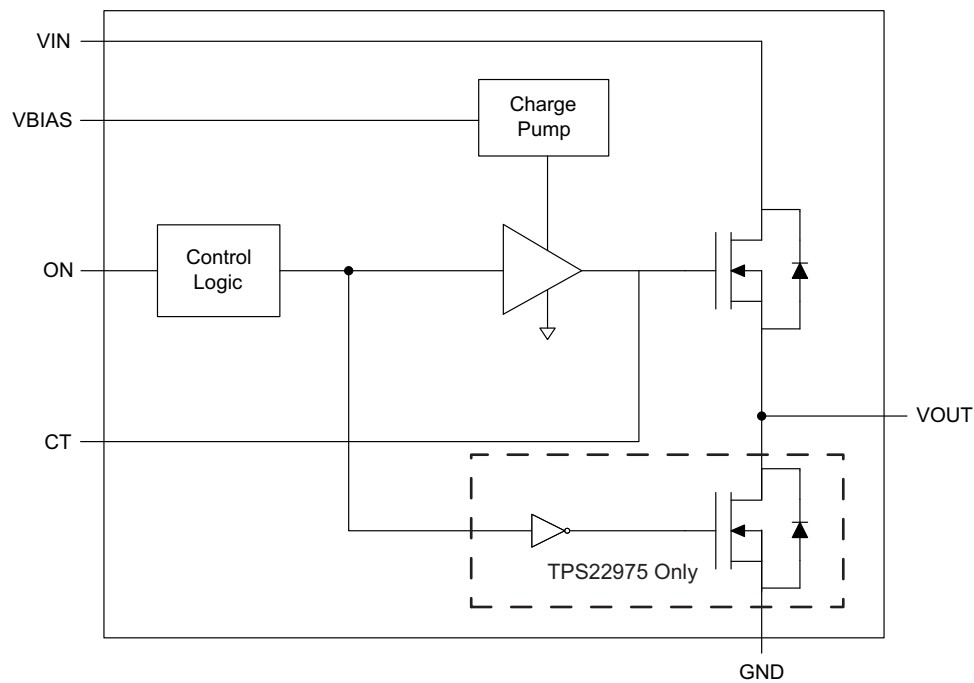

Copyright © 2016, Texas Instruments Incorporated

## 9.3 Feature Description

### 9.3.1 Adjustable Rise Time

A capacitor to GND on the CT pin sets the slew rate. The voltage on the CT pin can be as high as 15 V; therefore, the minimum voltage rating for the CT capacitor must be 30 V for optimal performance. An approximate formula for the relationship between  $C_T$  and slew rate when  $V_{BIAS}$  is set to 5 V is shown in Equation 1. This equation accounts for 10% to 90% measurement on  $V_{OUT}$  and does not apply for  $C_T < 100$  pF. Use Table 1 to determine rise times for when  $C_T = 0$  pF.

$$SR = 0.43 \times C_T + 26$$

where

- SR is the slew rate (in  $\mu\text{s/V}$ )
- $C_T$  is the capacitance value on the CT pin (in pF)
- The units for the constant 26 are  $\mu\text{s/V}$ . The units for the constant 0.43 are  $\mu\text{s}/(\text{V} \times \text{pF})$ . (1)

Rise time can be calculated by multiplying the input voltage by the slew rate. Table 1 contains rise time values measured on a typical device. Rise times shown in Table 1 are only valid for the power-up sequence where  $V_{IN}$  and  $V_{BIAS}$  are already in steady state condition before the ON pin is asserted high.

**Table 1. Rise Time  $t_R$  vs CT Capacitor**

$C_T$ (pF)	RISE TIME ( $\mu\text{s}$ ) 10% - 90%, $C_L = 0.1 \mu\text{F}$ , $C_{IN} = 1 \mu\text{F}$ , $R_L = 10 \Omega$ , $V_{BIAS} = 5 \text{ V}^{(1)}$						
	$V_{IN} = 5 \text{ V}$	$V_{IN} = 3.3 \text{ V}$	$V_{IN} = 1.8 \text{ V}$	$V_{IN} = 1.5 \text{ V}$	$V_{IN} = 1.2 \text{ V}$	$V_{IN} = 1.05 \text{ V}$	$V_{IN} = 0.6 \text{ V}$
0	140	105	75	65	60	55	40
220	520	360	215	185	160	140	95
470	970	660	385	330	275	240	155
1000	1750	1190	700	595	495	435	275
2200	3875	2615	1520	1290	1070	940	595
4700	7580	5110	2950	2510	2075	1830	1150
10000	16980	11485	6650	5635	4685	4110	2595

(1) Typical Values at 25°C with a 25-V X7R 10% Ceramic Capacitor on CT

### 9.3.2 Quick-Output Discharge (QOD) (Optional)

The TPS22975 includes an optional QOD feature. When the switch is disabled, an internal discharge resistance is connected between  $V_{OUT}$  and GND to remove the remaining charge from the output. This resistance has a typical value of 230  $\Omega$  and prevents the output from floating while the switch is disabled. For best results, it is recommended that the device gets disabled before  $V_{BIAS}$  falls below the minimum recommended voltage.

### 9.3.3 Thermal Shutdown

Thermal shutdown protects the part from internally or externally generated excessive temperatures. When the device temperature triggers  $T_{SD}$  (typical 160°C), the switch is turned off. The switch automatically turns on again if the temperature of the die drops 20 degrees below the  $T_{SD}$  threshold.

## 9.4 Device Functional Modes

The Table 2 lists the  $V_{OUT}$  pin states as determined by the ON pin.

**Table 2.  $V_{OUT}$  Connection**

ON	TPS22975	TPS22975N
L	GND	Open
H	VIN	VIN

## 10 Application and Implementation

### NOTE

Information in the following applications sections is not part of the TI component specification, and TI does not warrant its accuracy or completeness. TI's customers are responsible for determining suitability of components for their purposes. Customers should validate and test their design implementation to confirm system functionality.

### 10.1 Application Information

#### 10.1.1 ON and OFF Control

The ON pin controls the state of the switch. ON is active high and has a 1.2-V ON-pin enable threshold, making it capable of interfacing with low-voltage signals. The ON pin is compatible with standard GPIO logic thresholds. It can be used with any microcontroller with 1.2 V or higher GPIO voltage. This pin cannot be left floating and must be driven either high or low for proper functionality.

#### 10.1.2 Input Capacitor ( $C_{IN}$ ) (Optional)

To limit the voltage drop on the input supply caused by transient inrush currents when the switch turns on into a discharged load capacitor or short-circuit, a capacitor needs to be placed between  $V_{IN}$  and GND. A 1- $\mu$ F ceramic capacitor,  $C_{IN}$ , placed close to the pins, is usually sufficient. Higher values of  $C_{IN}$  can be used to further reduce the voltage drop during high current applications. When switching heavy loads, it is recommended to have an input capacitor about 10 times higher than the output capacitor ( $C_L$ ) to avoid excessive voltage drop.

#### 10.1.3 Output Capacitor ( $C_L$ ) (Optional)

Because of the integrated body diode in the NMOS switch, a  $C_{IN}$  greater than  $C_L$  is highly recommended. A  $C_L$  greater than  $C_{IN}$  can cause  $V_{OUT}$  to exceed  $V_{IN}$  when the system supply is removed. This could result in current flow through the body diode from  $V_{OUT}$  to  $V_{IN}$ . A  $C_{IN}$  to  $C_L$  ratio of 10 to 1 is recommended for minimizing  $V_{IN}$  dip caused by inrush currents during startup; however, a 10 to 1 ratio for capacitance is not required for proper functionality of the device. A ratio smaller than 10 to 1 (such as 1 to 1) could cause slightly more  $V_{IN}$  dip upon turn-on because of inrush currents. This can be mitigated by increasing the capacitance on the CT pin for a longer rise time (see the [Adjustable Rise Time](#) section).

### 10.2 Typical Application

For optimal  $R_{ON}$  performance, it is recommended to have  $V_{IN} \leq V_{BIAS}$ . The device is functional if  $V_{IN} > V_{BIAS}$  but it exhibits  $R_{ON}$  greater than what is listed in the [Electrical Characteristics— \$V\_{BIAS} = 5\$  V](#) and [Electrical Characteristics— \$V\_{BIAS} = 2.5\$  V](#) tables.

Figure 31 demonstrates how the TPS22975 can be used to power downstream modules.

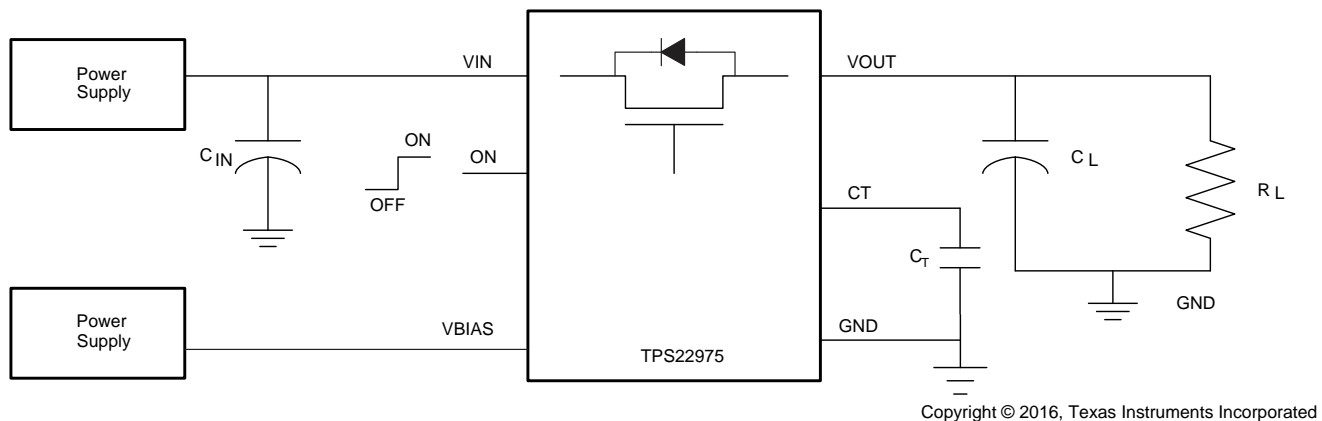

**Figure 31. Powering a Downstream Module**



## Typical Application (continued)

### 10.2.1 Design Requirements

DESIGN PARAMETER	EXAMPLE VALUE
$V_{IN}$	3.3 V
$V_{BIAS}$	5 V
$C_L$	22 $\mu$ F
Maximum Acceptable Inrush Current	400 mA

### 10.2.2 Detailed Design Procedure

#### 10.2.2.1 Inrush Current

When the switch is enabled, the output capacitors must be charged up from 0 V to the set value (3.3 V in this example). This charge arrives in the form of inrush current. Inrush current can be calculated using [Equation 2](#).

$$\text{Inrush Current} = C_L \times dV_{OUT}/dt$$

Where:

- $C_L$  is the output capacitance
- $dV_{OUT}$  is the change in  $V_{OUT}$  during the ramp up of the output voltage when device is enabled.
- $dt$  is the rise time in  $V_{OUT}$  during the ramp up of the output voltage when the device is enabled. (2)

The TPS22975 offers adjustable rise time for  $V_{OUT}$ . This feature allows the user to control the inrush current during turnon. The appropriate rise time can be calculated using the design requirements and the inrush current equation as shown in [Equation 3](#).

$$400 \text{ mA} = 22 \mu\text{F} \times 3.3 \text{ V}/dt \quad (3)$$

The value of  $dt$  is given by [Equation 4](#).

$$dt = 181.5 \mu\text{s} \quad (4)$$

To ensure an inrush current of less than 400 mA, choose a CT value that yields a rise time of more than 181.5  $\mu$ s. See the oscilloscope captures in the [Application Curves](#) section for an example of how the CT capacitor can be used to reduce inrush current.

### 10.2.3 Application Curves

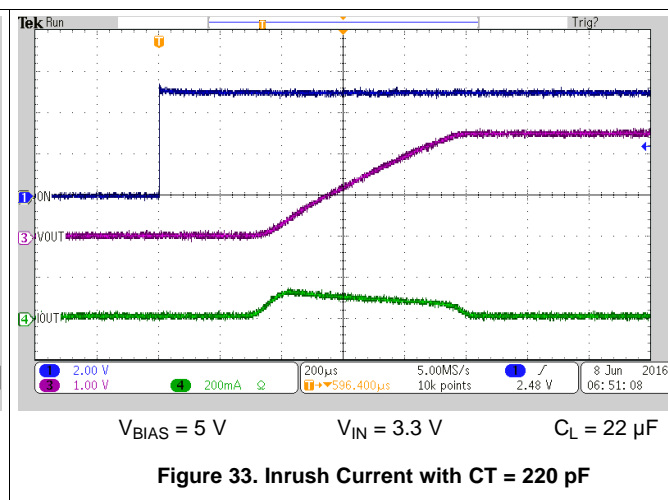
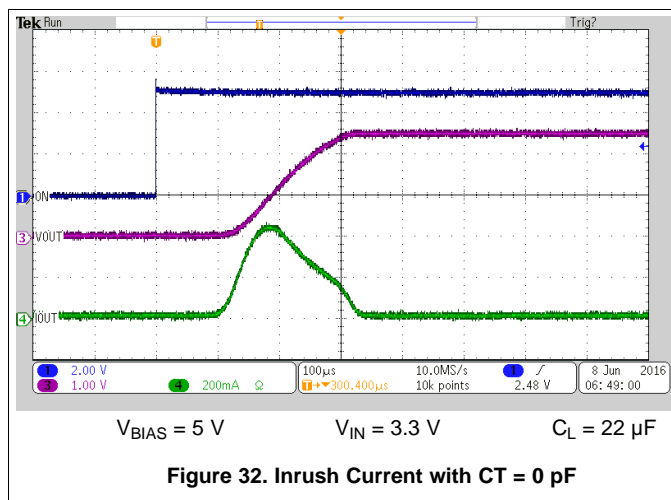

## 11 Power Supply Recommendations

The supply to the device must be well regulated and placed as close to the device terminal as possible with the recommended 1- $\mu$ F bypass capacitor. If the supply is located more than a few inches from the device terminals, additional bulk capacitance may be required in addition to the ceramic bypass capacitors. If additional bulk capacitance is required, an electrolytic, tantalum or ceramic capacitor of 1  $\mu$ F may be sufficient.

The TPS22975 operates regardless of power sequencing order. The order in which voltages are applied to  $V_{IN}$ ,  $V_{BIAS}$ , and ON does not damage the device as long as the voltages do not exceed the absolute maximum operating conditions. If voltage is applied to ON before  $V_{IN}$ , the slew rate of  $V_{OUT}$  can not be controlled.

## 12 Layout

### 12.1 Layout Guidelines

For best performance, all traces must be as short as possible. To be most effective, the input and output capacitors must be placed close to the device to minimize the effects that parasitic trace inductances may have on normal operation. Using wide traces for VIN, VOUT, and GND helps minimize the parasitic electrical effects along with minimizing the case to ambient thermal impedance. The CT trace must be as short as possible to reduce parasitic capacitance.

### 12.2 Layout Example

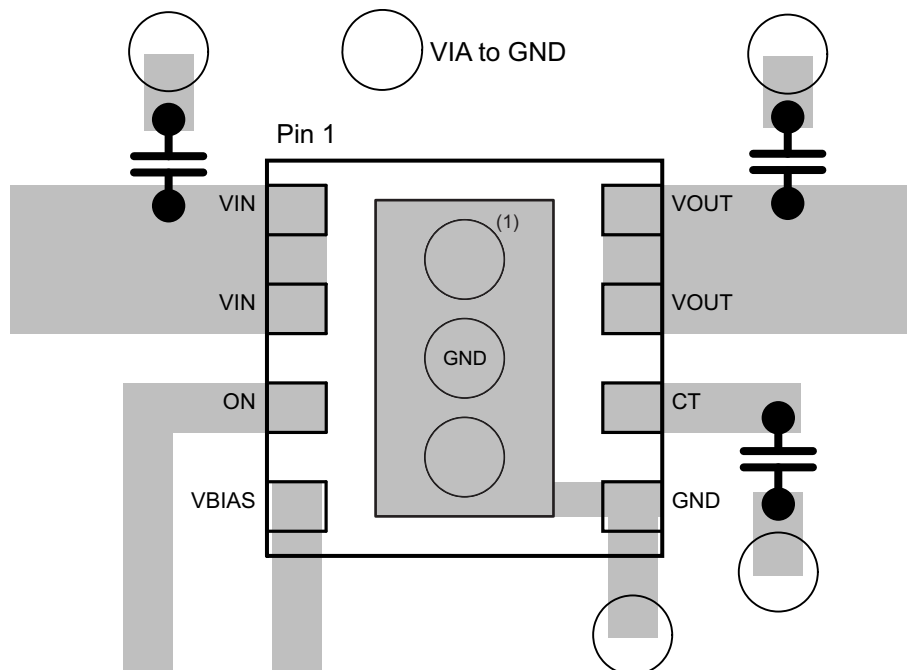

Figure 34. Layout Recommendation

### 12.3 Thermal Considerations

The maximum IC junction temperature must be restricted to 125°C under normal operating conditions. To calculate the maximum allowable dissipation,  $P_{D(max)}$ , for a given ambient temperature, use Equation 5 as a guideline.

$$P_{D(max)} = \frac{T_{J(max)} - T_A}{\theta_{JA}}$$

where

- $P_{D(max)}$  is the maximum allowable power dissipation
- $T_{J(max)}$  is the maximum allowable junction temperature (125°C for the TPS22975)
- $T_A$  is the ambient temperature of the device
- $\theta_{JA}$  is the junction to air thermal impedance. See the [Thermal Information](#) section. This parameter is highly dependent upon board layout. (5)

In Figure 34, notice that the thermal vias are located under the exposed thermal pad of the device. This allows for thermal diffusion away from the device.

## 13 器件和文档支持

### 13.1 器件支持

#### 13.1.1 开发支持

关于 TPS22975 PSpice 瞬态模型，请参见 [SLVMB06](#)。

### 13.2 相关文档

请参阅如下相关文档：

- 《负载开关导通电阻基础知识》，[SLVA771](#)
- 用户指南《TPS22975 负载开关评估模块》，[SLVUAR3](#)

### 13.3 接收文档更新通知

如需接收文档更新通知，请访问 [ti.com](http://ti.com) 上的器件产品文件夹。单击右上角的 [通知我](#) 进行注册，即可每周接收产品信息更改摘要。有关更改的详细信息，请查看任何已修订文档中包含的修订历史记录。

### 13.4 社区资源

下列链接提供到 TI 社区资源的连接。链接的内容由各个分销商“按照原样”提供。这些内容并不构成 TI 技术规范，并且不一定反映 TI 的观点；请参阅 TI 的《[使用条款](#)》。

**TI E2E™ 在线社区** [TI 的工程师对工程师 \(E2E\) 社区](#)。此社区的创建目的在于促进工程师之间的协作。在 [e2e.ti.com](http://e2e.ti.com) 中，您可以咨询问题、分享知识、拓展思路并与同行工程师一道帮助解决问题。

**设计支持** [TI 参考设计支持](#) 可帮助您快速查找有帮助的 E2E 论坛、设计支持工具以及技术支持的联系信息。

### 13.5 商标

E2E is a trademark of Texas Instruments.

Ultrabook is a trademark of Intel.

All other trademarks are the property of their respective owners.

### 13.6 静电放电警告



ESD 可能会损坏该集成电路。德州仪器 (TI) 建议通过适当的预防措施处理所有集成电路。如果不遵守正确的处理措施和安装程序，可能会损坏集成电路。

ESD 的损坏小至导致微小的性能降级，大至整个器件故障。精密的集成电路可能更容易受到损坏，这是因为非常细微的参数更改都可能会导致器件与其发布的规格不相符。

### 13.7 Glossary

[SLYZ022](#) — *TI Glossary*.

This glossary lists and explains terms, acronyms, and definitions.

## 14 机械、封装和可订购信息

以下页面包含机械、封装和可订购信息。这些信息是指定器件的最新可用数据。这些数据如有变更，恕不另行通知和修订此文档。如欲获取此数据表的浏览器版本，请参阅左侧的导航。

**PACKAGING INFORMATION**

Orderable Device	Status (1)	Package Type	Package Drawing	Pins	Package Qty	Eco Plan (2)	Lead finish/ Ball material (6)	MSL Peak Temp (3)	Op Temp (°C)	Device Marking (4/5)	Samples
TPS22975DSGR	ACTIVE	WSON	DSG	8	3000	RoHS & Green	NIPDAU	Level-1-260C-UNLIM	-40 to 105	13XH	<a href="#">Samples</a>
TPS22975DSGT	ACTIVE	WSON	DSG	8	250	RoHS & Green	NIPDAU	Level-1-260C-UNLIM	-40 to 105	13XH	<a href="#">Samples</a>
TPS22975NDSGR	ACTIVE	WSON	DSG	8	3000	RoHS & Green	NIPDAU	Level-1-260C-UNLIM	-40 to 105	14YH	<a href="#">Samples</a>
TPS22975NDSGT	ACTIVE	WSON	DSG	8	250	RoHS & Green	NIPDAU	Level-1-260C-UNLIM	-40 to 105	14YH	<a href="#">Samples</a>

(1) The marketing status values are defined as follows:

**ACTIVE:** Product device recommended for new designs.

**LIFEBUY:** TI has announced that the device will be discontinued, and a lifetime-buy period is in effect.

**NRND:** Not recommended for new designs. Device is in production to support existing customers, but TI does not recommend using this part in a new design.

**PREVIEW:** Device has been announced but is not in production. Samples may or may not be available.

**OBSELETE:** TI has discontinued the production of the device.

(2) **RoHS:** TI defines "RoHS" to mean semiconductor products that are compliant with the current EU RoHS requirements for all 10 RoHS substances, including the requirement that RoHS substance do not exceed 0.1% by weight in homogeneous materials. Where designed to be soldered at high temperatures, "RoHS" products are suitable for use in specified lead-free processes. TI may reference these types of products as "Pb-Free".

**RoHS Exempt:** TI defines "RoHS Exempt" to mean products that contain lead but are compliant with EU RoHS pursuant to a specific EU RoHS exemption.

**Green:** TI defines "Green" to mean the content of Chlorine (Cl) and Bromine (Br) based flame retardants meet JS709B low halogen requirements of <=1000ppm threshold. Antimony trioxide based flame retardants must also meet the <=1000ppm threshold requirement.

(3) MSL, Peak Temp. - The Moisture Sensitivity Level rating according to the JEDEC industry standard classifications, and peak solder temperature.

(4) There may be additional marking, which relates to the logo, the lot trace code information, or the environmental category on the device.

(5) Multiple Device Markings will be inside parentheses. Only one Device Marking contained in parentheses and separated by a "-" will appear on a device. If a line is indented then it is a continuation of the previous line and the two combined represent the entire Device Marking for that device.

(6) Lead finish/Ball material - Orderable Devices may have multiple material finish options. Finish options are separated by a vertical ruled line. Lead finish/Ball material values may wrap to two lines if the finish value exceeds the maximum column width.

**Important Information and Disclaimer:**The information provided on this page represents TI's knowledge and belief as of the date that it is provided. TI bases its knowledge and belief on information provided by third parties, and makes no representation or warranty as to the accuracy of such information. Efforts are underway to better integrate information from third parties. TI has taken and

continues to take reasonable steps to provide representative and accurate information but may not have conducted destructive testing or chemical analysis on incoming materials and chemicals. TI and TI suppliers consider certain information to be proprietary, and thus CAS numbers and other limited information may not be available for release.

In no event shall TI's liability arising out of such information exceed the total purchase price of the TI part(s) at issue in this document sold by TI to Customer on an annual basis.

**TAPE AND REEL INFORMATION**

**QUADRANT ASSIGNMENTS FOR PIN 1 ORIENTATION IN TAPE**

\*All dimensions are nominal

Device	Package Type	Package Drawing	Pins	SPQ	Reel Diameter (mm)	Reel Width W1 (mm)	A0 (mm)	B0 (mm)	K0 (mm)	P1 (mm)	W (mm)	Pin1 Quadrant
TPS22975DSGR	WSON	DSG	8	3000	180.0	8.4	2.3	2.3	1.15	4.0	8.0	Q2
TPS22975DSGT	WSON	DSG	8	250	180.0	8.4	2.3	2.3	1.15	4.0	8.0	Q2
TPS22975NDSGR	WSON	DSG	8	3000	180.0	8.4	2.3	2.3	1.15	4.0	8.0	Q2
TPS22975NDSGT	WSON	DSG	8	250	180.0	8.4	2.3	2.3	1.15	4.0	8.0	Q2

**TAPE AND REEL BOX DIMENSIONS**

\*All dimensions are nominal

Device	Package Type	Package Drawing	Pins	SPQ	Length (mm)	Width (mm)	Height (mm)
TPS22975DSGR	WSON	DSG	8	3000	210.0	185.0	35.0
TPS22975DSGT	WSON	DSG	8	250	210.0	185.0	35.0
TPS22975NDSGR	WSON	DSG	8	3000	210.0	185.0	35.0
TPS22975NDSGT	WSON	DSG	8	250	210.0	185.0	35.0



## GENERIC PACKAGE VIEW

**DSG 8**

**WSON - 0.8 mm max height**

2 x 2, 0.5 mm pitch

PLASTIC SMALL OUTLINE - NO LEAD

This image is a representation of the package family, actual package may vary.  
Refer to the product data sheet for package details.



4224783/A

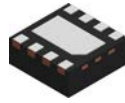

ALTERNATIVE TERMINAL SHAPE TYPICAL



SIDE WALL METAL THICKNESS DIM A	
OPTION 1	OPTION 2
0.1	0.2

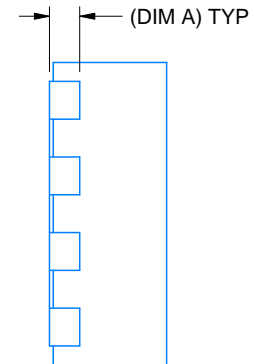

4218900/E 08/2022

NOTES:

1. All linear dimensions are in millimeters. Any dimensions in parenthesis are for reference only. Dimensioning and tolerancing per ASME Y14.5M.
2. This drawing is subject to change without notice.
3. The package thermal pad must be soldered to the printed circuit board for thermal and mechanical performance.

# EXAMPLE BOARD LAYOUT

DSG0008A

WSON - 0.8 mm max height

PLASTIC SMALL OUTLINE - NO LEAD



LAND PATTERN EXAMPLE  
SCALE:20X



SOLDER MASK DETAILS

4218900/E 08/2022

NOTES: (continued)

4. This package is designed to be soldered to a thermal pad on the board. For more information, see Texas Instruments literature number SLUA271 ([www.ti.com/lit/slua271](http://www.ti.com/lit/slua271)).
5. Vias are optional depending on application, refer to device data sheet. If any vias are implemented, refer to their locations shown on this view. It is recommended that vias under paste be filled, plugged or tented.

# EXAMPLE STENCIL DESIGN

DSG0008A

WSON - 0.8 mm max height

PLASTIC SMALL OUTLINE - NO LEAD



SOLDER PASTE EXAMPLE  
BASED ON 0.125 mm THICK STENCIL

EXPOSED PAD 9:  
87% PRINTED SOLDER COVERAGE BY AREA UNDER PACKAGE  
SCALE:25X

4218900/E 08/2022

NOTES: (continued)

6. Laser cutting apertures with trapezoidal walls and rounded corners may offer better paste release. IPC-7525 may have alternate design recommendations.

## 重要声明和免责声明

TI“按原样”提供技术和可靠性数据（包括数据表）、设计资源（包括参考设计）、应用或其他设计建议、网络工具、安全信息和其他资源，不保证没有瑕疵且不做任何明示或暗示的担保，包括但不限于对适销性、某特定用途方面的适用性或不侵犯任何第三方知识产权的暗示担保。

这些资源可供使用 TI 产品进行设计的熟练开发人员使用。您将自行承担以下全部责任：(1) 针对您的应用选择合适的 TI 产品，(2) 设计、验证并测试您的应用，(3) 确保您的应用满足相应标准以及任何其他功能安全、信息安全、监管或其他要求。

这些资源如有变更，恕不另行通知。TI 授权您仅可将这些资源用于研发本资源所述的 TI 产品的应用。严禁对这些资源进行其他复制或展示。您无权使用任何其他 TI 知识产权或任何第三方知识产权。您应全额赔偿因在这些资源的使用中对 TI 及其代表造成的任何索赔、损害、成本、损失和债务，TI 对此概不负责。

TI 提供的产品受 [TI 的销售条款](#) 或 [ti.com](#) 上其他适用条款/TI 产品随附的其他适用条款的约束。TI 提供这些资源并不会扩展或以其他方式更改 TI 针对 TI 产品发布的适用的担保或担保免责声明。

TI 反对并拒绝您可能提出的任何其他或不同的条款。

邮寄地址：Texas Instruments, Post Office Box 655303, Dallas, Texas 75265

Copyright © 2023，德州仪器 (TI) 公司