

## TPS370x-xx 具有电源故障检测功能的处理器监控电路

### 1 特性

- 具有 200ms 固定延时时间的上电复位发生器 ( 无需外部电容器 )
- 精密电源电压监控器 : 2.5V、3V、3.3V 和 5V
- 与 MAX705 至 MAX708 系列引脚对引脚兼容
- 集成看门狗时间 ( 仅限 TPS3705-xx )
- 用于电源故障或低电池电量警告的电压监控器
- 50 $\mu$ A 最大电源电流
- 8 引脚 MSOP 和 8 引脚 SOIC 封装
- 温度范围 : -40°C 至 85°C  
( TPS3705-33 为 -40°C 至 125°C )

### 2 应用

- 使用 DSP、微控制器或微处理器的设计
- 工业设备
- 可编程控制
- 汽车系统
- 便携式或电池供电类设备
- 智能仪表
- 无线通信系统
- 笔记本电脑或台式机

### 3 说明

TPS370x-xx 系列微处理器电源电压监控器主要为 DSP 以及基于其他处理器的系统提供电路初始化和时序监控。

上电期间, 如果电源电压  $V_{DD}$  大于 1.1V,  $\overline{RESET}$  就会生效。因此, 只要  $V_{DD}$  保持在阈值电压  $V_{IT+}$  以下, 电源电压监控器就会监测  $V_{DD}$ , 并使  $\overline{RESET}$  保持有效状态。当电源电压降到阈值电压  $V_{IT-}$  以下时, 输出再次变为有效状态 ( 低电平 )。无需外部组件。该系列中的所有器件均具有一个通过内部分压器设定的固定检测阈值电压  $V_{IT-}$ 。

该产品系列专为 2.5V、3V、3.3V 以及 5V 电源电压而设计。这些电路采用 8 引脚 MSOP 或标准 SOIC 封装。TPS370x-xx 器件的额定工作温度范围为 -40°C 至 85°C。

#### 器件信息(1)

器件型号	封装	封装尺寸 ( 标称值 )
TPS3705-xx、 TPS3707-xx	MSOP- PowerPAD™ (8)	3.00mm × 3.00mm
	SOIC (8)	3.90mm × 4.90mm

(1) 如需了解所有可用封装, 请参阅数据表末尾的可订购产品附录。

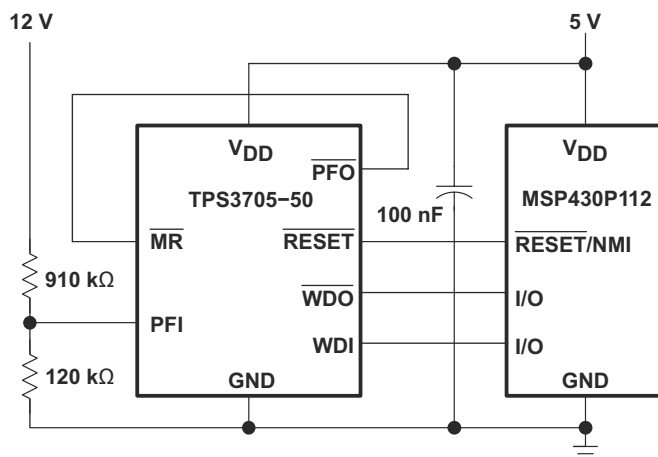

Copyright © 2016, Texas Instruments Incorporated

#### MSP430 典型应用



## Table of Contents

<b>1 特性</b> .....	1	8.1 Overview.....	16
<b>2 应用</b> .....	1	8.2 Functional Block Diagram.....	16
<b>3 说明</b> .....	1	8.3 Feature Description.....	16
<b>4 Revision History</b> .....	2	8.4 Device Functional Modes.....	17
<b>5 Device Comparison Table</b> .....	3	<b>9 Application and Implementation</b> .....	18
<b>6 Pin Configuration and Functions</b> .....	4	9.1 Application Information.....	18
6.1 Pin Functions.....	4	9.2 Typical Application.....	18
<b>7 Specifications</b> .....	5	<b>10 Power Supply Recommendations</b> .....	20
7.1 Absolute Maximum Ratings.....	5	<b>11 Layout</b> .....	21
7.2 ESD Ratings.....	5	11.1 Layout Guidelines.....	21
7.3 Recommended Operating Conditions.....	5	11.2 Layout Example.....	21
7.4 Thermal Information.....	6	<b>12 Device and Documentation Support</b> .....	22
7.5 Electrical Characteristics.....	7	12.1 接收文档更新通知.....	22
7.6 Electrical Characteristics for TPS3705-33 Only.....	8	12.2 支持资源.....	22
7.7 Timing Requirements.....	8	12.3 Trademarks.....	22
7.8 Switching Characteristics.....	9	12.4 静电放电警告.....	22
7.9 Dissipation Ratings.....	9	12.5 术语表.....	22
7.10 Timing Diagram.....	10	<b>13 Mechanical, Packaging, and Orderable Information</b> .....	22
7.11 Typical Characteristics.....	11		
<b>8 Detailed Description</b> .....	16		

## 4 Revision History

注：以前版本的页码可能与当前版本的页码不同

<b>Changes from Revision E (July 2017) to Revision F (October 2020)</b>	<b>Page</b>
• 更新了整个文档中的表格、图和交叉参考的编号格式.....	1
• Updated Device Comparison Table by adding -40°C to 125°C for TPS3705-33D.....	3
• Updated Absolute Maximum Ratings table to include Operating Temperature of -40°C to 125°C for TPS3705-33D.....	5
• Added TPS3705-33 Electrical Table.....	8
• Added histograms.....	11

---

<b>Changes from Revision D (May 2016) to Revision E (July 2017)</b>	<b>Page</b>
• 更新了器件信息表中的封装尺寸.....	1

---

<b>Changes from Revision C (December 2005) to Revision D (May 2016)</b>	<b>Page</b>
• 添加了 ESD 等级表、特性说明部分、器件功能模式、应用和实施部分、电源相关建议部分、布局部分、器件和文档支持部分以及机械、封装和可订购信息部分.....	1

## 5 Device Comparison Table

T <sub>A</sub>	THRESHOLD VOLTAGE	PACKAGED DEVICES		MARKING DGN PACKAGE	CHIP FORM (Y)
		SMALL OUTLINE (D)	POWER-PAD μ-SMALL OUTLINE (DGN)		
- 40°C to 85°C	2.63 V	TPS3705-30D	TPS3705-30DGN	TIAAT	TPS3705-30Y
	4.55 V	TPS3705-50D	TPS3705-50DGN	TIAAV	TPS3705-50Y
	2.25 V	TPS3707-25D	TPS3707-25DGN	TIAAW	TPS3707-25Y
	2.63 V	TPS3707-30D	TPS3707-30DGN	TIAAX	TPS3707-30Y
	2.93 V	TPS3707-33D	TPS3707-33DGN	TIAAY	TPS3707-33Y
	4.55 V	TPS3707-50D	TPS3707-50DGN	TIAAZ	TPS3707-50Y
- 40°C to 125°C	2.93 V	TPS3705-33D	TPS3705-33DGN	TIAAU	TPS3705-33Y

## 6 Pin Configuration and Functions



图 6-1. TPS3705-xx D Package 8-Pin SOIC Top View



图 6-2. TPS3707-xx D Package 8-Pin SOIC Top View

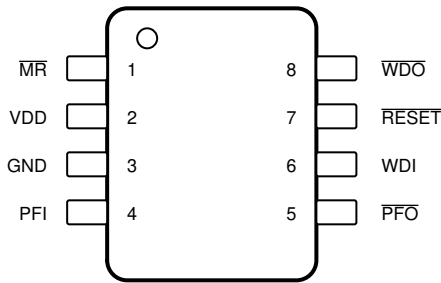

图 6-3. TPS3705-xx DGN Package 8-Pin MSOP-PowerPAD Top View

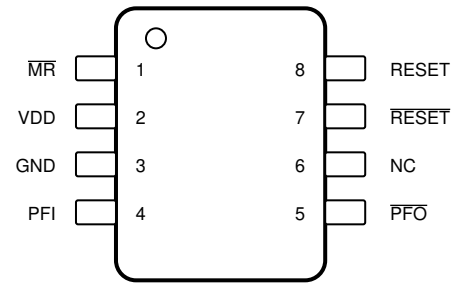

图 6-4. TPS3707-xx DGN Package 8-Pin MSOP-PowerPAD Top View

### 6.1 Pin Functions

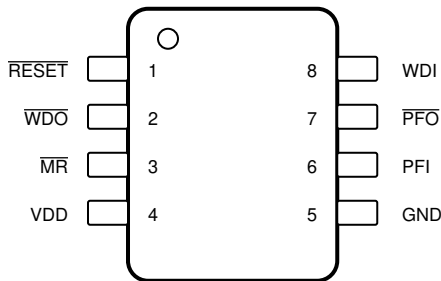
NAME	PIN				I/O	DESCRIPTION
	TPS3705-xx		TPS3707-xx			
	SOIC	MSOP-PowerPAD	SOIC	MSOP-PowerPAD		
GND	3	5	3	5	—	Ground
MR	1	3	1	3	I	Manual reset
NC	—	—	6	8	—	No internal connection
PFI	4	6	4	6	I	Power-fail comparator input
PFO	5	7	5	7	O	Power-fail comparator output
RESET	7	1	7	1	O	Active-low reset output
RESET	—	—	8	2	O	Active-high reset output
V <sub>DD</sub>	2	4	2	4	—	Supply voltage
WDI	6	8	—	—	I	Watchdog timer input
WDO	8	2	—	—	O	Watchdog timer output

## 7 Specifications

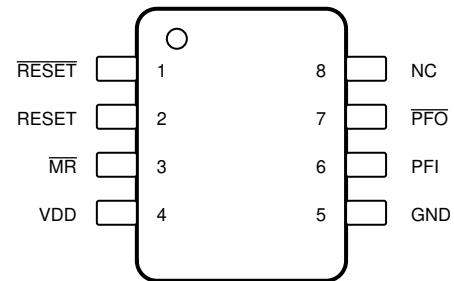
### 7.1 Absolute Maximum Ratings

over operating free-air temperature range (unless otherwise noted)<sup>(1)</sup>

	MIN	MAX	UNIT
Supply voltage, $V_{DD}$ <sup>(2)</sup>		7	V
PFI voltage range, $V_{PFI}$	- 0.3	$V_{DD} + 0.3$	V
All other pins <sup>(2)</sup>	- 0.3	7	V
Maximum low output current, $I_{OL}$		5	mA
Maximum high output current, $I_{OH}$		- 5	mA
Input clamp current, $I_{IK}$ ( $V_I < 0$ or $V_I > V_{DD}$ )		±20	mA
Output clamp current, $I_{OK}$ ( $V_O < 0$ or $V_O > V_{DD}$ )		±20	mA
Continuous total power dissipation	See <a href="#"># 7.9</a>		
Soldering temperature		260	°C
Operating temperature, $T_A$	- 40	85	°C
Operating temperature, $T_A$ for TPS3705-33 only	- 40	125	°C
Storage temperature, $T_{stg}$	- 65	150	°C

- (1) Stresses beyond those listed under *Absolute Maximum Ratings* may cause permanent damage to the device. These are stress ratings only, which do not imply functional operation of the device at these or any other conditions beyond those indicated under *Recommended Operating Conditions*. Exposure to absolute-maximum-rated conditions for extended periods may affect device reliability.
- (2) All voltage values are with respect to GND. For reliable operation the device must not be operated at 7 V for more than  $t = 1000h$  continuously.

### 7.2 ESD Ratings

		VALUE	UNIT
$V_{(ESD)}$ Electrostatic discharge	Human-body model (HBM), per ANSI/ESDA/JEDEC JS-001 <sup>(1)</sup>	±2000	V
	Charged-device model (CDM), per JEDEC specification JESD22-C101 <sup>(2)</sup>	±500	

- (1) JEDEC document JEP155 states that 500-V HBM allows safe manufacturing with a standard ESD control process.
- (2) JEDEC document JEP157 states that 250-V CDM allows safe manufacturing with a standard ESD control process.

### 7.3 Recommended Operating Conditions

over operating free-air temperature range (unless otherwise noted)

		MIN	NOM	MAX	UNIT
$V_{DD}$	Supply voltage	2		6	V
$V_I$	Input voltage	0		$V_{DD} + 0.3$	V
$V_{IH}$	High-level input voltage	$0.7 \times V_{DD}$			V
$V_{IL}$	Low-level input voltage			$0.3 \times V_{DD}$	V
$\Delta t / \Delta V$	Input transition rise and fall rate at $\overline{MR}$ or WDI			100	ns/V
$T_A$	Operating free-air temperature	- 40		85	°C
$T_A$	Operating free-air temperature for TPS3705-33 only	- 40		125	°C

## 7.4 Thermal Information

THERMAL METRIC <sup>(1)</sup>		TPS3705-xx	TPS3707-xx	UNIT
		D (SOIC)	DGN (MSOP-PowerPAD)	
		8 PINS	8 PINS	
$R_{\theta JA}$	Junction-to-ambient thermal resistance	118.2	66.1	°C/W
$R_{\theta JC(top)}$	Junction-to-case (top) thermal resistance	64.4	62.6	°C/W
$R_{\theta JB}$	Junction-to-board thermal resistance	58.5	45.1	°C/W
$\psi_{JT}$	Junction-to-top characterization parameter	15.8	7.6	°C/W
$\psi_{JB}$	Junction-to-board characterization parameter	57.9	44.8	°C/W
$R_{\theta JC(bot)}$	Junction-to-case (bottom) thermal resistance	—	18.5	°C/W

- (1) For more information about traditional and new thermal metrics, see the [Semiconductor and IC Package Thermal Metrics](#) application report.

## 7.5 Electrical Characteristics

over operating free-air temperature range (unless otherwise noted)

PARAMETER		TEST CONDITIONS	MIN	TYP	MAX	UNIT
V <sub>OH</sub>	High-level output voltage	TPS370x-xx, V <sub>DD</sub> = 1.1 V, I <sub>OH</sub> = -4 μA	0.8			V
		TPS3707-25, TPS370x-30, TPS370x-33, V <sub>DD</sub> = V <sub>IT+</sub> + 0.2 V, I <sub>OH</sub> = -500 μA	0.7 × V <sub>DD</sub>			
		TPS370x-50, V <sub>DD</sub> = V <sub>IT+</sub> + 0.2 V, I <sub>OH</sub> = -800 μA	V <sub>DD</sub> - 1.5			
		TPS370x-xx, V <sub>DD</sub> = 6 V, I <sub>OH</sub> = -800 μA	V <sub>DD</sub> - 1.5			
V <sub>OL</sub>	Low-level output voltage	TPS3707-25, TPS370x-30, TPS370x-33, V <sub>DD</sub> = V <sub>IT+</sub> + 0.2 V, I <sub>OL</sub> = 1 mA	0.3			V
		TPS370x-50, V <sub>DD</sub> = V <sub>IT+</sub> + 0.2 V, I <sub>OL</sub> = 2.5 mA	0.4			
		TPS370x-xx, V <sub>DD</sub> = 6 V, I <sub>OL</sub> = 3 mA	0.4			
Power-up reset voltage <sup>(1)</sup>		V <sub>DD</sub> ≥ 1.1 V, I <sub>OL</sub> = 50 μA	0.3			V
V <sub>IT-</sub>	Negative-going input threshold voltage <sup>(2)</sup>	TPS3707-25, T <sub>A</sub> = 0°C to 85°C	2.2	2.25	2.3	V
		TPS370x-30, T <sub>A</sub> = 0°C to 85°C	2.57	2.63	2.68	
		TPS370x-33, T <sub>A</sub> = 0°C to 85°C	2.87	2.93	2.98	
		TPS370x-50, T <sub>A</sub> = 0°C to 85°C	4.45	4.55	4.63	
		TPS3707-25, T <sub>A</sub> = -40°C to 85°C	2.2	2.25	2.32	
		TPS370x-30, T <sub>A</sub> = -40°C to 85°C	2.57	2.63	2.7	
		TPS370x-33, T <sub>A</sub> = -40°C to 85°C	2.87	2.93	3	
	TPS370x-50, T <sub>A</sub> = -40°C to 85°C	4.45	4.55	4.65		
	Negative-going input threshold voltage, PFI <sup>(2)</sup>	TPS370x-xx, V <sub>DD</sub> ≥ 2 V, T <sub>A</sub> = -40°C to 85°C	1.2	1.25	1.3	
V <sub>hys</sub>	Hysteresis, V <sub>DD</sub>	TPS3707-25	40			mV
		TPS370x-30	50			
		TPS370x-33	50			
		TPS370x-50	70			
	Hysteresis, PFI	TPS370x-xx	10			
I <sub>IH(AV)</sub>	Average high-level input current, WDI	WDI = V <sub>DD</sub> = 6 V, time average (dc = 88%)	100	150	μA	
I <sub>IL(AV)</sub>	Average low-level input current, WDI	WDI = 0 V, V <sub>DD</sub> = 6 V, time average (dc = 12%)	-15	-20	μA	
I <sub>IH</sub>	High-level input current, WDI	WDI = V <sub>DD</sub> = 6 V	120	170	μA	
	High-level input current, MR	MR = 0.7 × V <sub>DD</sub> , V <sub>DD</sub> = 6 V	-130	-180		
I <sub>IL</sub>	Low-level input current, WDI	WDI = 0 V, V <sub>DD</sub> = 6 V	-120	-170	μA	
	Low-level input current, MR	MR = 0 V, V <sub>DD</sub> = 6 V	-430	-600		
I <sub>I</sub>	Input current, PFI	V <sub>DD</sub> = 6 V, 0 V ≤ V <sub>I</sub> ≤ V <sub>DD</sub>	-1	0	1	μA
I <sub>DD</sub>	Supply current	TPS3705-xx, V <sub>DD</sub> = 2 V to 6 V, MR = V <sub>DD</sub> , MR, WDI and outputs unconnected	30	50	μA	
		TPS3707-xx, V <sub>DD</sub> = 2 V to 6 V, MR = V <sub>DD</sub> , MR, WDI and outputs unconnected	20	50		
C <sub>i</sub>	Input capacitance	V <sub>I</sub> = 0 V to V <sub>DD</sub>	5			pF

(1) The lowest supply voltage at which RESET becomes active, t<sub>r,VDD</sub> ≥ 15 μs/V

(2) To ensure best stability of the threshold voltage, a bypass capacitor (ceramic, 0.1 μF) should be placed near to the supply terminals

## 7.6 Electrical Characteristics for TPS3705-33 Only

over operating free-air temperature range -40 to 125°C (unless otherwise noted)

PARAMETER		TEST CONDITIONS	MIN	TYP	MAX	UNIT
V <sub>OH</sub>	High-level output voltage	V <sub>DD</sub> = 1.1 V, I <sub>OH</sub> = -4 μA	0.8			V
		V <sub>DD</sub> = V <sub>IT+</sub> + 0.2 V, I <sub>OH</sub> = -500 μA	0.7 × V <sub>DD</sub>			
		V <sub>DD</sub> = 6 V, I <sub>OH</sub> = -800 μA	V <sub>DD</sub> - 1.5			
V <sub>OL</sub>	Low-level output voltage	V <sub>DD</sub> = V <sub>IT+</sub> + 0.2 V, I <sub>OL</sub> = 1 mA	0.3			V
		V <sub>DD</sub> = 6 V, I <sub>OL</sub> = 3 mA	0.4			
Power-up reset voltage <sup>(1)</sup>		V <sub>DD</sub> ≥ 1.1 V, I <sub>OL</sub> = 50 μA	0.3			V
V <sub>IT-</sub>	Negative-going input threshold voltage	T <sub>A</sub> = 0°C to 125°C	2.87	2.93	3	V
		T <sub>A</sub> = -40°C to 125°C	2.87	2.93	3.02	
	Negative-going input threshold voltage, PFI <sup>(2)</sup>	V <sub>DD</sub> ≥ 2 V	1.2	1.25	1.3	
V <sub>hys</sub>	Hysteresis, V <sub>DD</sub>		50			mV
	Hysteresis, PFI		10			
I <sub>IH(AV)</sub>	Average high-level input current, WDI	WDI = V <sub>DD</sub> = 6 V, time average (dc = 88%)		100	150	μA
I <sub>IL(AV)</sub>	Average low-level input current, WDI	WDI = 0 V, V <sub>DD</sub> = 6 V, time average (dc = 12%)		-15	-20	μA
I <sub>IH</sub>	High-level input current, WDI	WDI = V <sub>DD</sub> = 6 V		120	170	μA
	High-level input current, MR	MR = 0.7 × V <sub>DD</sub> , V <sub>DD</sub> = 6 V		-130	-180	
I <sub>IL</sub>	Low-level input current, WDI	WDI = 0 V, V <sub>DD</sub> = 6 V		-120	-170	μA
	Low-level input current, MR	MR = 0 V, V <sub>DD</sub> = 6 V		-430	-600	
I <sub>I</sub>	Input current, PFI	V <sub>DD</sub> = 6 V, 0 V ≤ V <sub>I</sub> ≤ V <sub>DD</sub>	-1	0	1	μA
I <sub>DD</sub>	Supply current	V <sub>DD</sub> = 2 V to 6 V, MR = V <sub>DD</sub> , MR, WDI and outputs unconnected		30	50	μA
C <sub>i</sub>	Input capacitance	V <sub>I</sub> = 0 V to V <sub>DD</sub>		5		pF

## 7.7 Timing Requirements

at R<sub>L</sub> = 1 MΩ, C<sub>L</sub> = 50 pF, T<sub>A</sub> = 25°C (unless otherwise noted)

PARAMETER	TEST CONDITIONS	MIN	NOM	MAX	UNIT
t <sub>w</sub>	At V <sub>DD</sub> , V <sub>DD</sub> = V <sub>IT+</sub> + 0.2 V, V <sub>DD</sub> = V <sub>IT-</sub> - 0.2 V	6			μs
	At MR and WDI, V <sub>DD</sub> ≥ V <sub>IT+</sub> + 0.2 V, V <sub>IL</sub> = 0.3 × V <sub>DD</sub> , V <sub>IH</sub> = 0.7 × V <sub>DD</sub>	100			ns



## 7.8 Switching Characteristics

at  $R_L = 1\text{ M}\Omega$ ,  $C_L = 50\text{ pF}$ ,  $T_A = 25^\circ\text{C}$  (unless otherwise noted)

PARAMETER		TEST CONDITIONS	MIN	TYP	MAX	UNIT
$t_{(out)}$	Watchdog time out	$V_{DD} \geq V_{IT+} + 0.2\text{ V}$ , see <a href="#">图 7-1</a>	1.1	1.6	2.3	s
$t_d$	Delay time	$V_{DD} \geq V_{IT+} + 0.2\text{ V}$ , see <a href="#">图 7-1</a>	140	200	280	ms
$t_{PHL}$	Propagation (delay) time, high-to-low-level output	$\overline{MR}$ to $\overline{RESET}$ delay, $V_{DD} \geq V_{IT+} + 0.2\text{ V}$ , $V_{IL} = 0.3 \times V_{DD}$ , $V_{IH} = 0.7 \times V_{DD}$		50	250	ns
$t_{PLH}$	Propagation (delay) time, low-to-high-level output	$\overline{MR}$ to $\overline{RESET}$ delay (TPS3707-xx only) $V_{DD} \geq V_{IT+} + 0.2\text{ V}$ , $V_{IL} = 0.3 \times V_{DD}$ , $V_{IH} = 0.7 \times V_{DD}$		50	250	ns
$t_{PHL}$	Propagation (delay) time, high-to-low-level output	$V_{DD}$ to $\overline{RESET}$ delay		3	5	$\mu\text{s}$
$t_{PLH}$	Propagation (delay) time, low-to-high-level output	$V_{DD}$ to $\overline{RESET}$ delay (TPS3707-xx only)		3	5	$\mu\text{s}$
$t_{PHL}$	Propagation (delay) time, high-to-low-level output	PFI to $\overline{PF0}$ delay, $V_{DD} = 2\text{ V}$ to $6\text{ V}$		0.5	1	$\mu\text{s}$
$t_{PLH}$	Propagation (delay) time, low-to-high-level output	PFI to $\overline{PF0}$ delay, $V_{DD} = 2\text{ V}$ to $6\text{ V}$		0.5	1	$\mu\text{s}$

## 7.9 Dissipation Ratings

PACKAGE	$T_A < 25^\circ\text{C}$ POWER RATING	DERATING FACTOR ABOVE $T_A = 25^\circ\text{C}$	$T_A = 70^\circ\text{C}$ POWER RATING	$T_A = 85^\circ\text{C}$ POWER RATING
DGN	2.14 W	17.1 mW/ $^\circ\text{C}$	1.37 W	1.11 W
D	725 mW	5.8 mW/ $^\circ\text{C}$	464 mW	377 mW

## 7.10 Timing Diagram



图 7-1. Timing Diagrams

## 7.11 Typical Characteristics



图 7-2. Normalized Input Threshold Voltage vs Free-Air Temperature at  $V_{DD}$

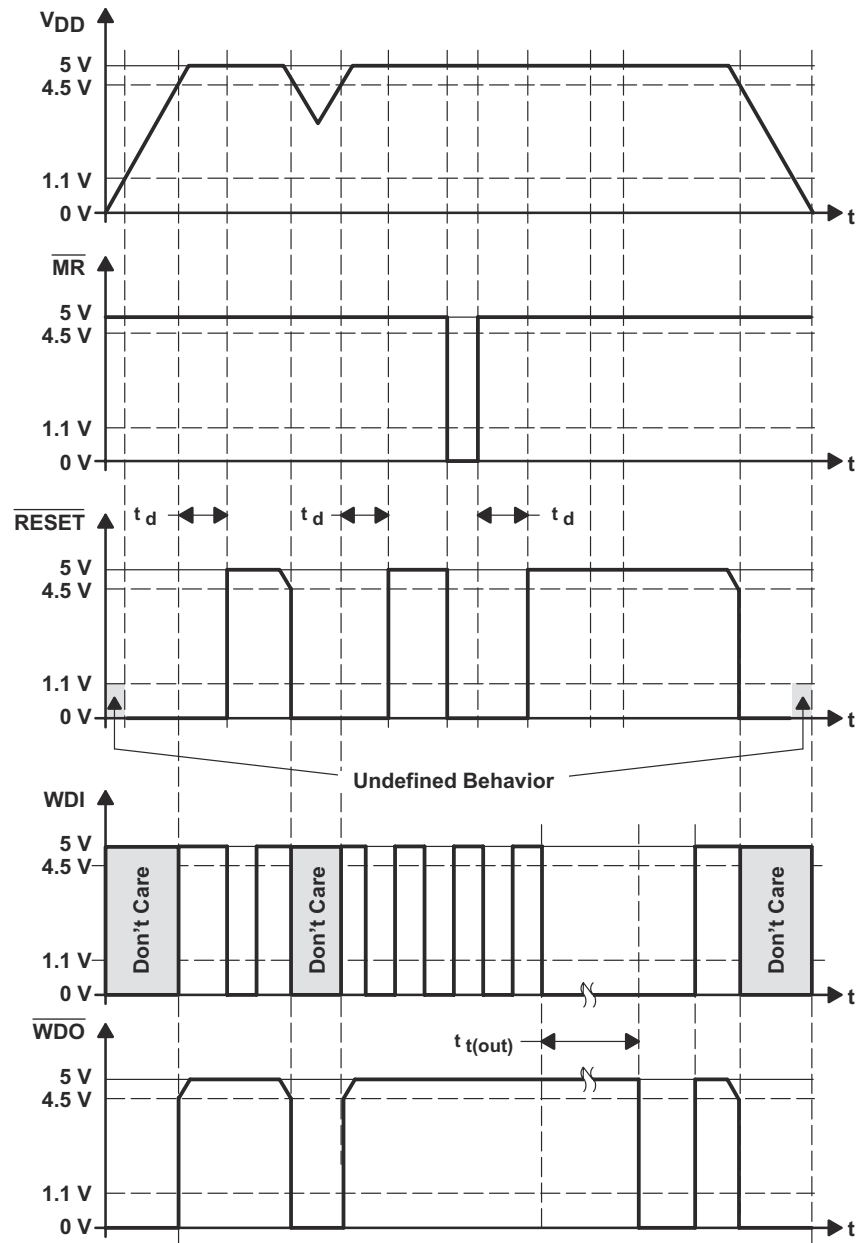

图 7-3. Supply Current vs Supply Voltage

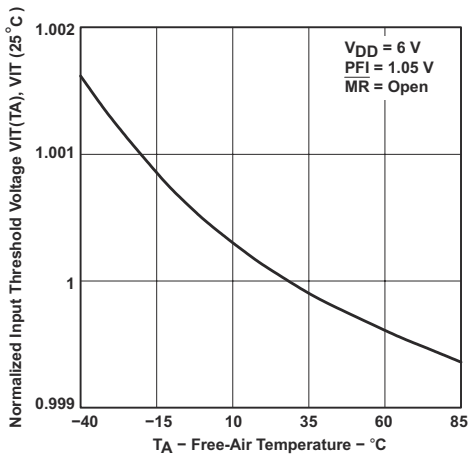

图 7-4. Input Current vs Input Voltage at  $\overline{MR}$

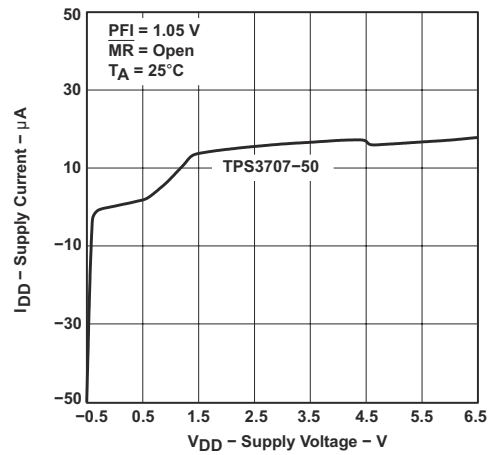

图 7-5. Minimum Pulse Duration at  $V_{DD}$  vs  $V_{DD}$  Threshold Overdrive

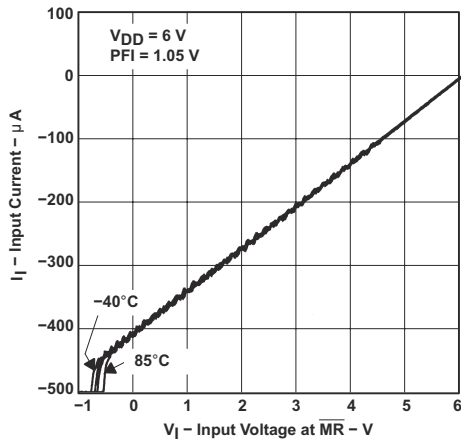

图 7-6. High-Level Output Voltage vs High-Level Output Current

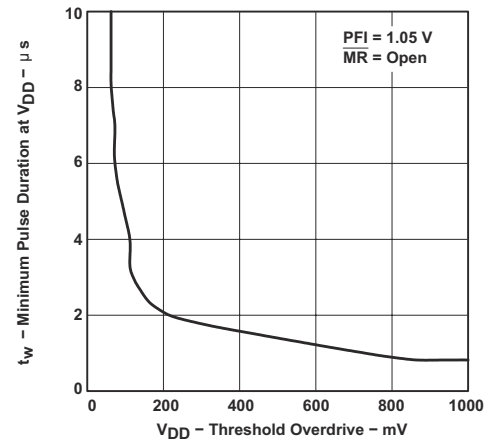

图 7-7. High-Level Output Voltage vs High-Level Output Current

### 7.11 Typical Characteristics (continued)

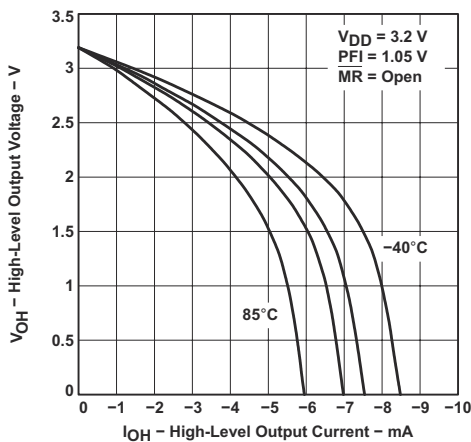

图 7-8. Low-Level Output Voltage vs Low-Level Output Current

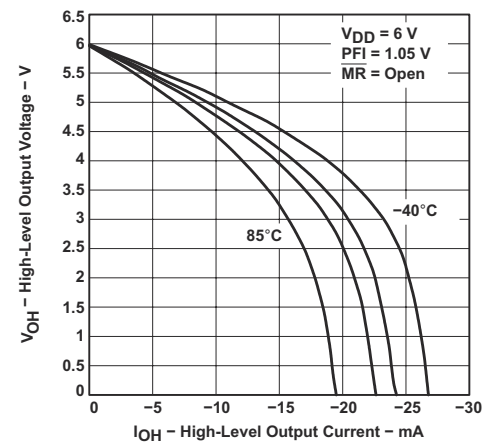

图 7-9. Watchdog Timeout Histogram for TSP3705-33 Devices at -40°C (Unit Count = 20)

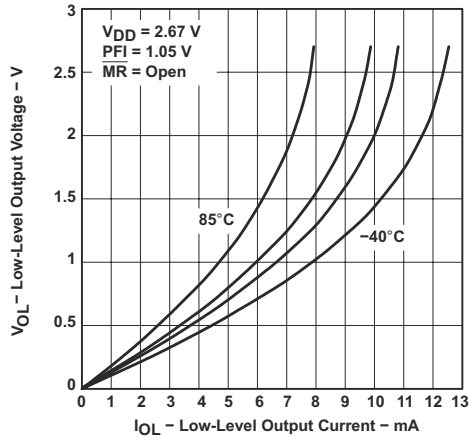

图 7-10. Watchdog Timeout Histogram for TSP3705-33 Devices at 25°C (Unit Count = 20)

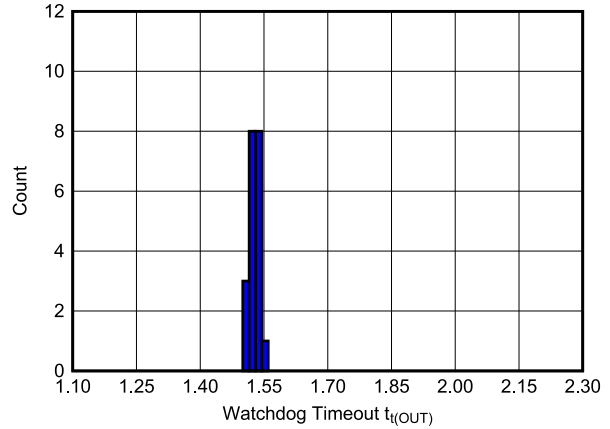

图 7-11. Watchdog Timeout Histogram for TSP3705-33 Devices at 125°C (Unit Count = 20)

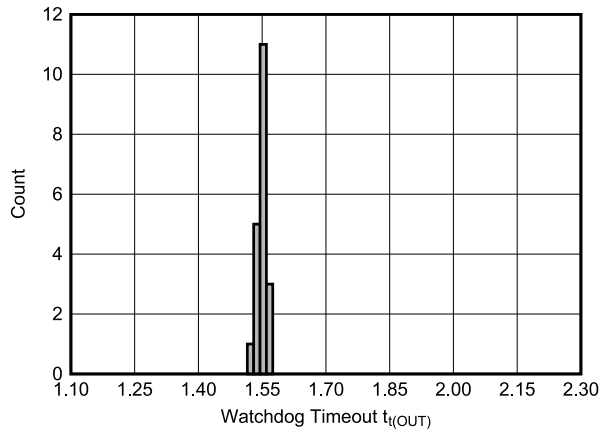

图 7-12. Reset Delay Histogram for TPS3705-33 Devices at -40°C (Unit Count = 20)

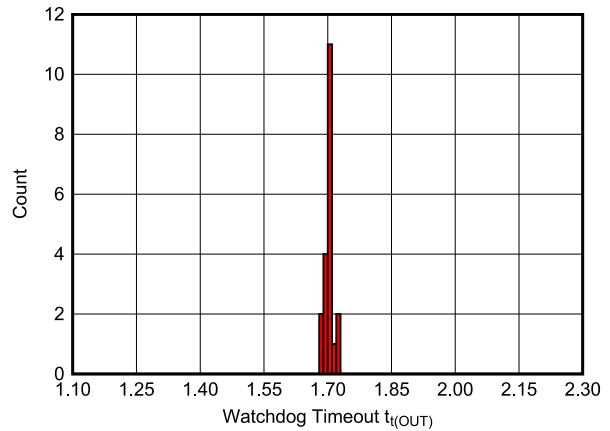

图 7-13. Reset Delay Histogram for TPS3705-33 Devices at 25°C (Unit Count = 20)

### 7.11 Typical Characteristics (continued)

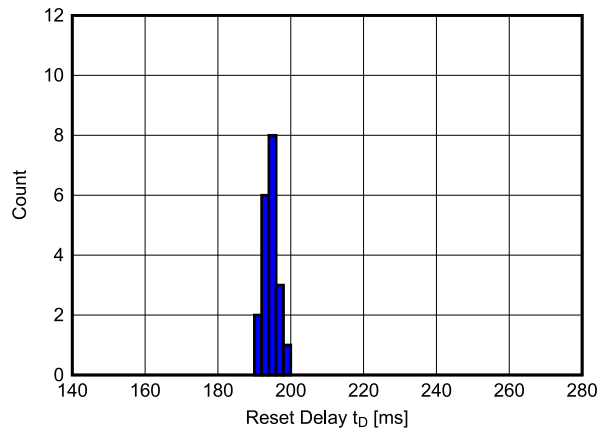

图 7-14. Reset Delay Histogram for TPS3705-33 Devices at 125°C (Unit Count = 20)

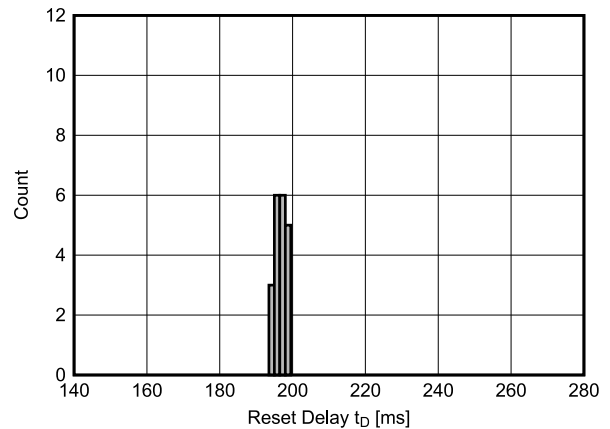

图 7-15.  $\overline{\text{MR}}$  to  $\overline{\text{RESET}}$  ( $t_{\text{PHL}}$ ) Delay Histogram for TPS3705-33 Devices at -40°C (Unit Count = 20)

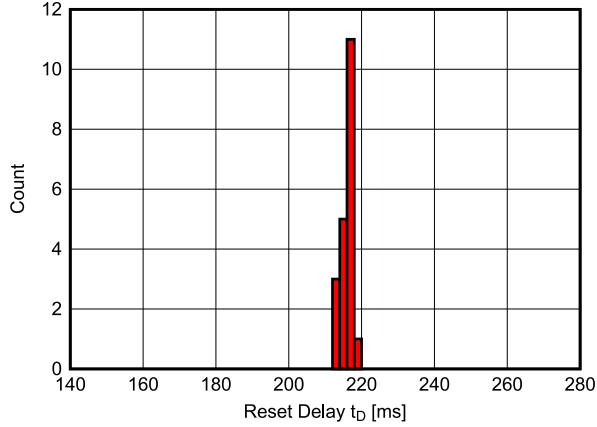

图 7-16.  $\overline{\text{MR}}$  to  $\overline{\text{RESET}}$  ( $t_{\text{PHL}}$ ) Delay Histogram for TPS3705-33 Devices at 25°C (Unit Count = 20)

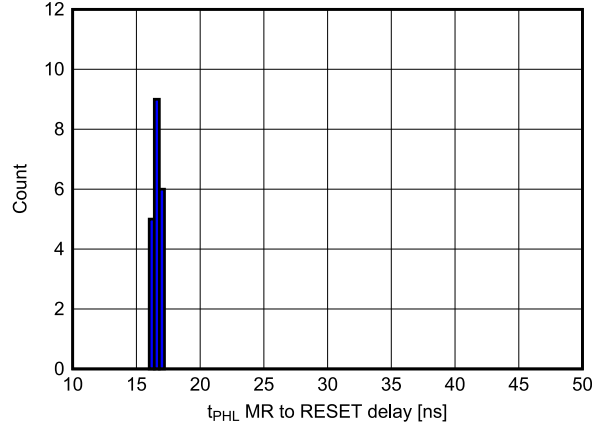

图 7-17.  $\overline{\text{MR}}$  to  $\overline{\text{RESET}}$  ( $t_{\text{PHL}}$ ) Delay Histogram for TPS3705-33 Devices at 125°C (Unit Count = 20)

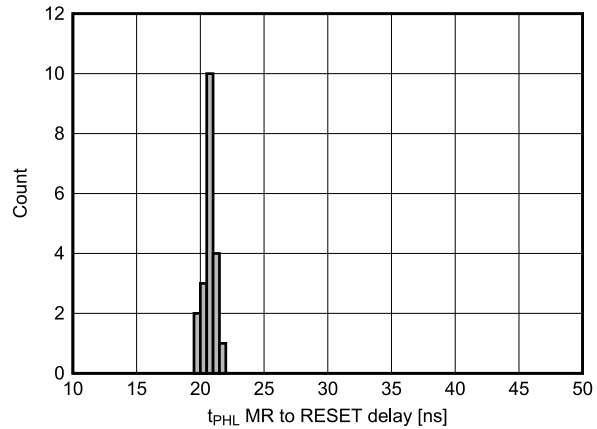

图 7-18.  $V_{\text{DD}}$  to  $\overline{\text{RESET}}$  ( $t_{\text{PHL}}$ ) Delay Histogram for TPS3705-33 Devices at -40°C (Unit Count = 20)

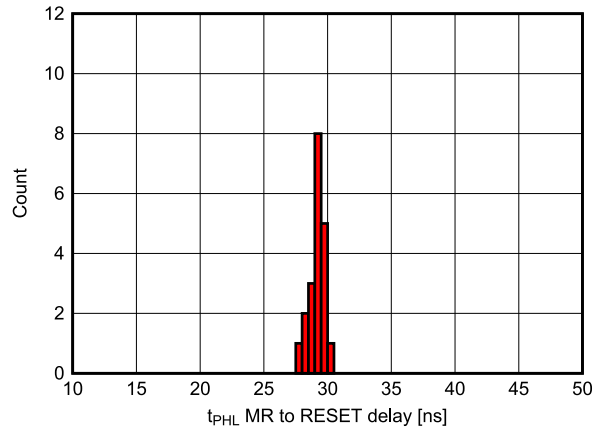

图 7-19.  $V_{\text{DD}}$  to  $\overline{\text{RESET}}$  ( $t_{\text{PHL}}$ ) Delay Histogram for TPS3705-33 Devices at 25°C (Unit Count = 20)

### 7.11 Typical Characteristics (continued)

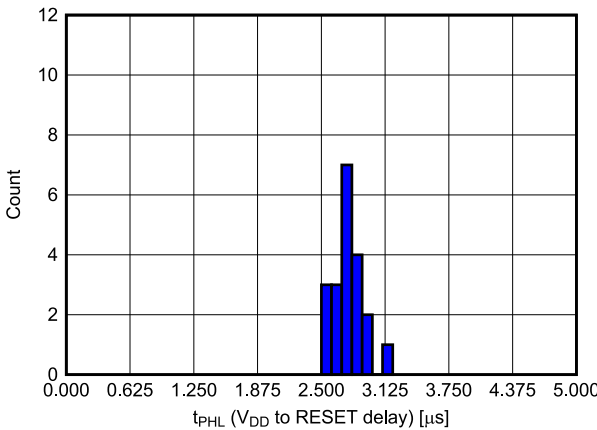

图 7-20. V<sub>DD</sub> to RESET ( $t_{PHL}$ ) Delay Histogram for TPS3705-33 Devices at 125°C (Unit Count = 20)

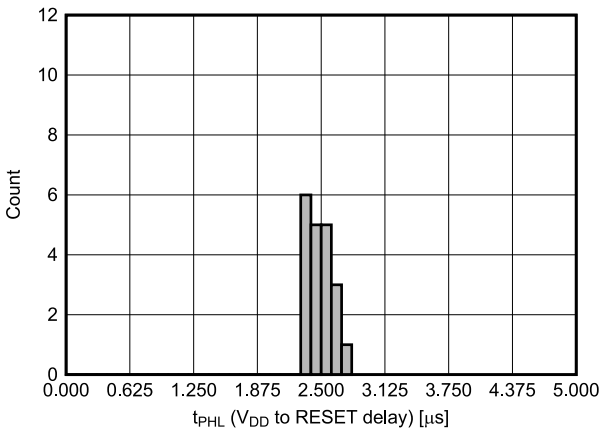

图 7-21. PFI to PFO ( $t_{PHL}$ ) Delay Histogram for TPS3705-33 Devices at -40°C (Unit Count = 20)

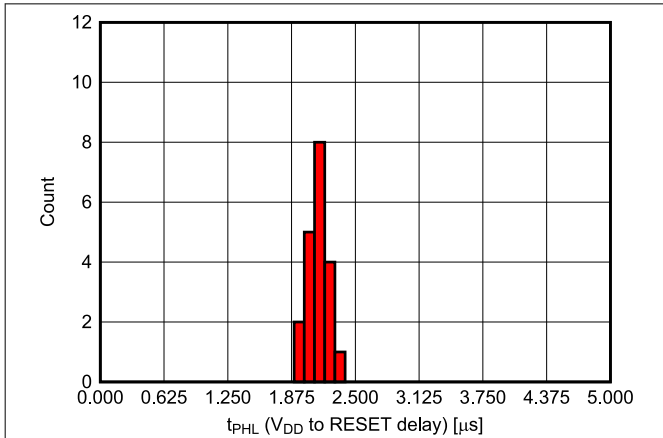

图 7-22. PFI to PFO ( $t_{PHL}$ ) Delay Histogram for TPS3705-33 Devices at 25°C (Unit Count = 20)

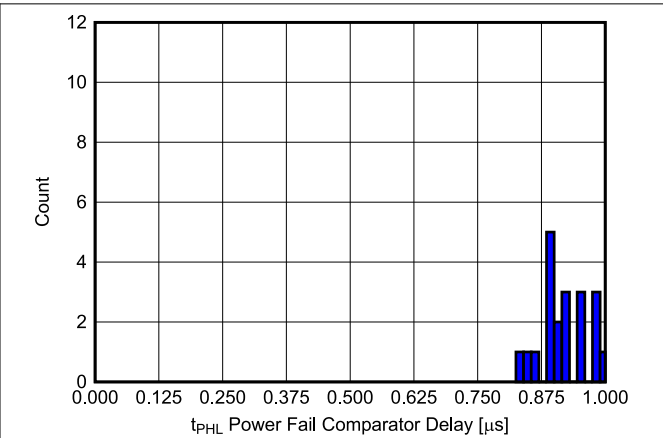

图 7-23. PFI to PFO ( $t_{PHL}$ ) Delay Histogram for TPS3705-33 Devices at 125°C (Unit Count = 20)

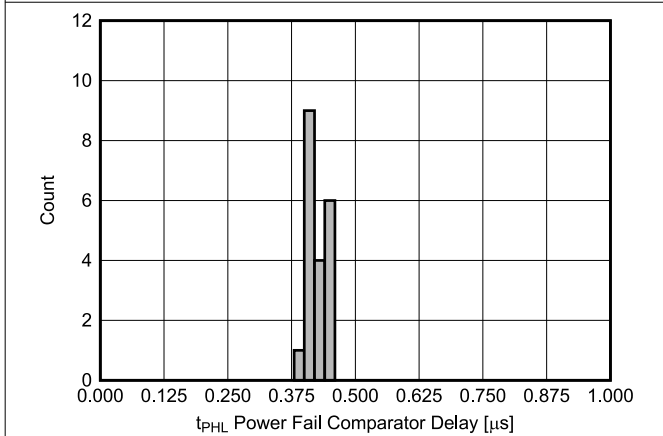

图 7-24. PFI to PFO ( $t_{PLH}$ ) Delay Histogram for TPS3705-33 Devices at -40°C (Unit Count = 20)

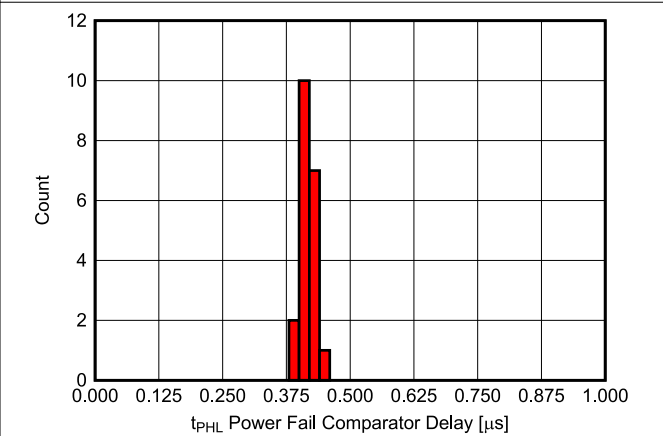

图 7-25. PFI to PFO ( $t_{PLH}$ ) Delay Histogram for TPS3705-33 Devices at 25°C (Unit Count = 20)

### 7.11 Typical Characteristics (continued)

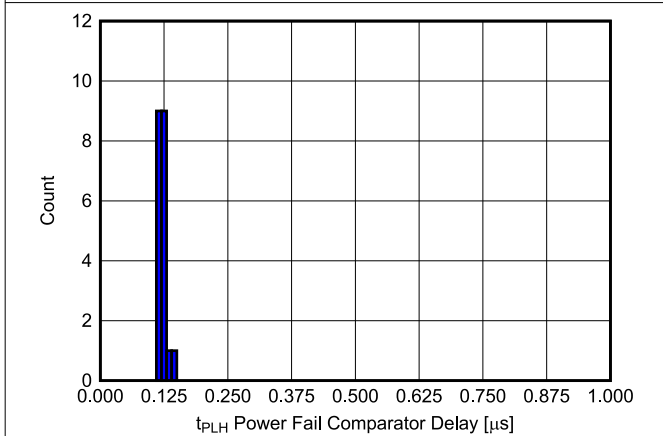

图 7-26. PFI to  $\overline{PFO}$  ( $t_{PLH}$ ) Delay Histogram for TPS3705-33 Devices at 125°C (Unit Count = 20)

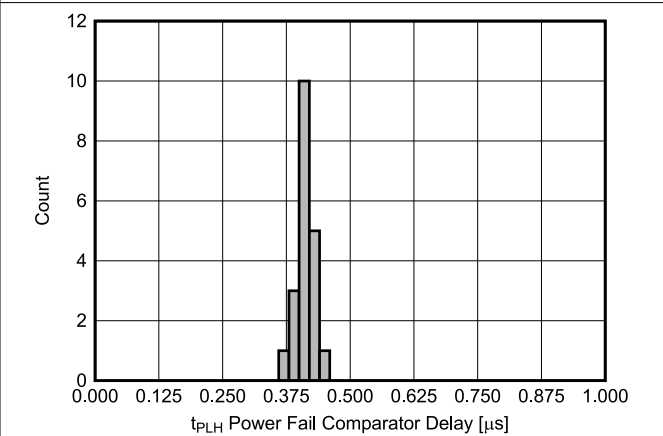
## 8 Detailed Description

### 8.1 Overview

The TPS370x-xx family of supervisors feature an integrated reference and comparator for  $V_{DD}$  supervision, an additional power-fail supervisor, and a manual reset input. The TPS3705-xx devices feature a watchdog timer, where the TPS3707-xx devices feature a complimentary RESET output.

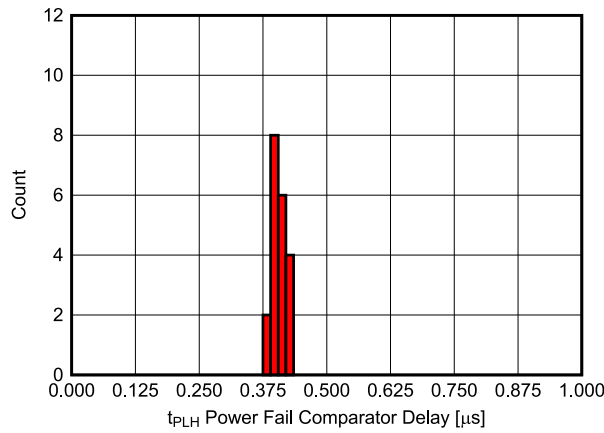
### 8.2 Functional Block Diagram

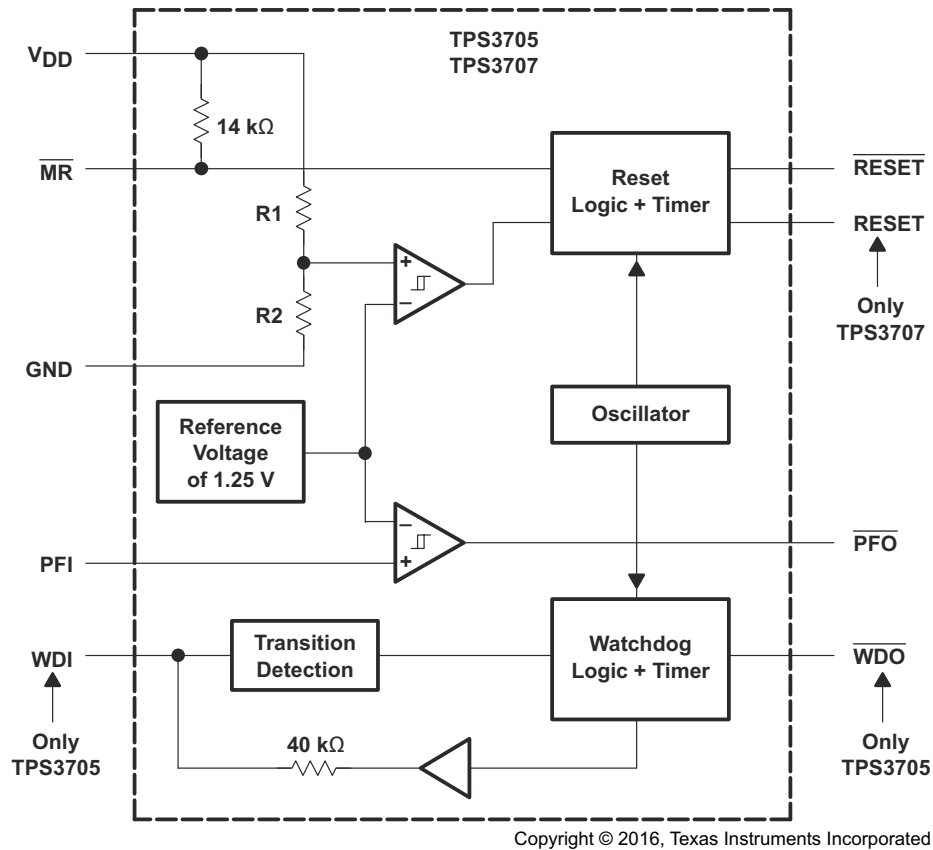

### 8.3 Feature Description

#### 8.3.1 Manual Reset Input

The TPS370x-xx devices incorporate a manual reset input,  $\overline{MR}$ . A low level at  $\overline{MR}$  causes  $\overline{RESET}$  to become active.

#### 8.3.2 Power-Fail Comparator

The TPS370x-xx family integrates a power-fail comparator which can be used for low-battery detection, power-fail warning, or for monitoring a power supply other than the main supply.

#### 8.3.3 Watchdog Timer

The TPS3705-xx devices have a watchdog timer that is periodically triggered by a positive or negative transition at WDI. When the supervising system fails to retrigger the watchdog circuit within the timeout interval,  $t_{t(out)} = 1.6$  s,  $\overline{WDO}$  becomes active. This event also reinitializes the watchdog timer. Leaving WDI unconnected disables the watchdog.

The TPS3707-xx devices do not have the watchdog function, but include a high-level output RESET.



## 8.4 Device Functional Modes

### 8.4.1 $V_{DD} < 1.1\text{ V}$

When  $V_{DD}$  is less than 1.1 V, the status of the outputs cannot be determined.

### 8.4.2 $1.1\text{ V} < V_{DD} \leq 2\text{ V}$

When  $V_{DD}$  is greater than 1.1 V but less than 2 V, the output states are valid. However, the specifications in [节 7.5](#) do not apply.

### 8.4.3 $2\text{ V} < V_{DD} < 6\text{ V}$

When  $V_{DD}$  is greater than 2 V but less than 6 V, the device is within the recommended operating conditions (see [节 7.3](#)). See [表 8-1](#), [表 8-2](#), and [表 8-3](#) for corresponding truth tables.

表 8-1. TPS3705 Truth Table

MR	$V_{DD} > V_{IT}$	RESET	TYPICAL DELAY
H → L	1	H → L	30 ns
L → H	1	L → H	200 ms
H	1 → 0	H → L	3 μs
H	0 → 1	L → H	200 ms

表 8-2. TPS3707 Truth Table

MR	$V_{DD} > V_{IT}$	RESET	RESET	TYPICAL DELAY
H → L	1	H → L	L → H	30 ns
L → H	1	L → H	H → L	200 ms
H	1 → 0	H → L	L → H	3 μs
H	0 → 1	L → H	H → L	200 ms

表 8-3. TPS370x Truth Table

PFI > $V_{IT}$	PFO	TYPICAL DELAY
0 → 1	L → H	0.5 μs
1 → 0	H → L	0.5 μs

## 9 Application and Implementation

### 备注

以下应用部分的信息不属于 TI 组件规范，TI 不担保其准确性和完整性。客户应负责确定 TI 组件是否适用于其应用。客户应验证并测试其设计，以确保系统功能。

### 9.1 Application Information

The TPS370x-xx family of devices offers several options for power monitoring. The TPS3705-xx offers a watchdog supervisor,  $V_{DD}$  rail monitoring, and a power-fail interrupt monitor. The TPS3707-xx offers  $V_{DD}$  rail monitoring with complimentary outputs and a power-fail interrupt monitor.

### 9.2 Typical Application

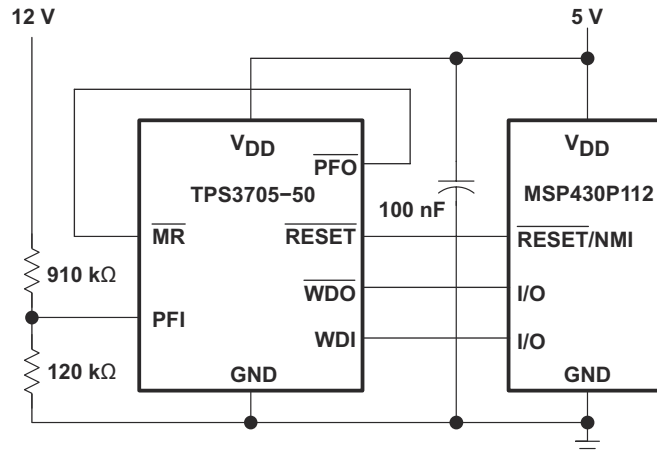

Copyright © 2016, Texas Instruments Incorporated

图 9-1. Typical MSP430 Application

#### 9.2.1 Design Requirements

表 9-1 lists the required design parameters for 图 9-1.

表 9-1. Application Parameters

DESIGN PARAMETER	VALUE
Monitored voltage 1	5 V
Monitored voltage 2	12 V

#### 9.2.2 Detailed Design Procedure

To create two voltage monitoring rails, the PFI input can be used along with the MR pin to create a single output. The 5-V monitor is created by selecting a 5-V device option, giving threshold of 4.55 V. The PFI input is configured to any adjustable rail with a voltage divider. Use 方程式 1 to select resistors.

$$V_{TH} = \frac{R_1 + R_2}{R_2} \times V_{IT-} = \frac{910\text{ k} + 120\text{ k}}{120\text{ k}} \times 1.25 = 10.73\text{ V} \quad (1)$$

### 9.2.3 Application Curves

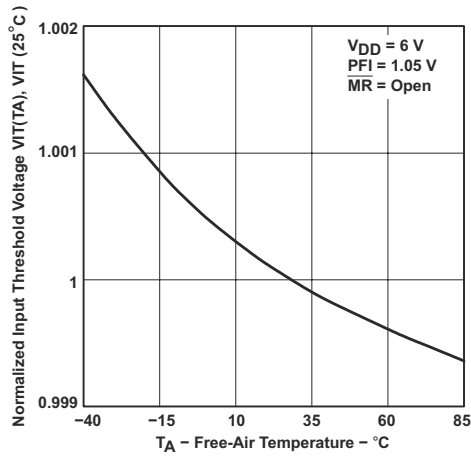

**图 9-2. Normalized Input Threshold Voltage vs Free-Air Temperature at  $V_{DD}$**

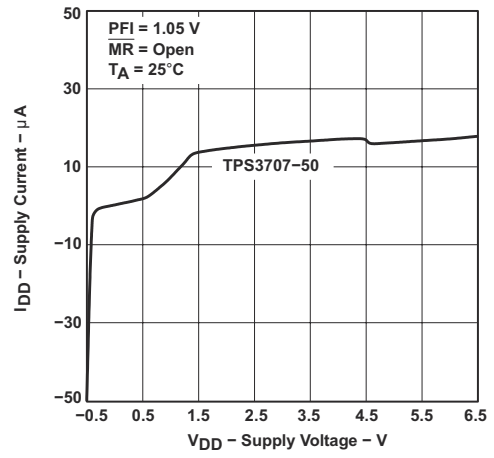

**图 9-3. Supply Current vs Supply Voltage**

## 10 Power Supply Recommendations

These devices are designed to operate from an input supply with a voltage range from 2 V to 6 V.

## 11 Layout

### 11.1 Layout Guidelines

Place a 0.1- $\mu$ F decoupling capacitor as close to the device as possible.

If a resistor divider is used, place the resistors as close to the device as possible to minimize noise coupling.

### 11.2 Layout Example



图 11-1. TPS3705 Layout

## 12 Device and Documentation Support

### 12.1 接收文档更新通知

要接收文档更新通知，请导航至 [ti.com](http://ti.com) 上的器件产品文件夹。点击 [订阅更新](#) 进行注册，即可每周接收产品信息更改摘要。有关更改的详细信息，请查看任何已修订文档中包含的修订历史记录。

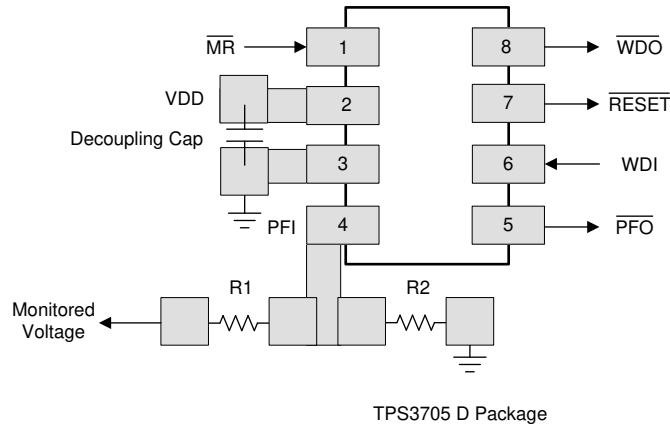
### 12.2 支持资源

**TI E2E™ 支持论坛** 是工程师的重要参考资料，可直接从专家获得快速、经过验证的解答和设计帮助。搜索现有解答或提出自己的问题可获得所需的快速设计帮助。

链接的内容由各个贡献者“按原样”提供。这些内容并不构成 TI 技术规范，并且不一定反映 TI 的观点；请参阅 TI 的《[使用条款](#)》。

### 12.3 Trademarks

PowerPAD™ and TI E2E™ are trademarks of Texas Instruments.

所有商标均为其各自所有者的财产。

### 12.4 静电放电警告



静电放电 (ESD) 会损坏这个集成电路。德州仪器 (TI) 建议通过适当的预防措施处理所有集成电路。如果不遵守正确的处理和安装程序，可能会损坏集成电路。

ESD 的损坏小至导致微小的性能降级，大至整个器件故障。精密的集成电路可能更容易受到损坏，这是因为非常细微的参数更改都可能会导致器件与其发布的规格不相符。

### 12.5 术语表

**TI 术语表** 本术语表列出并解释了术语、首字母缩略词和定义。

## 13 Mechanical, Packaging, and Orderable Information

The following pages include mechanical, packaging, and orderable information. This information is the most current data available for the designated devices. This data is subject to change without notice and revision of this document. For browser-based versions of this data sheet, refer to the left-hand navigation.

**PACKAGING INFORMATION**

Orderable Device	Status (1)	Package Type	Package Drawing	Pins	Package Qty	Eco Plan (2)	Lead finish/ Ball material (6)	MSL Peak Temp (3)	Op Temp (°C)	Device Marking (4/5)	Samples
TPS3705-30D	ACTIVE	SOIC	D	8	75	RoHS & Green	NIPDAU	Level-1-260C-UNLIM	-40 to 85	70530	<a href="#">Samples</a>
TPS3705-30DGN	ACTIVE	HVSSOP	DGN	8	80	RoHS & Green	NIPDAU	Level-1-260C-UNLIM	-40 to 85	AAT	<a href="#">Samples</a>
TPS3705-30DR	ACTIVE	SOIC	D	8	2500	RoHS & Green	NIPDAU	Level-1-260C-UNLIM	-40 to 85	70530	<a href="#">Samples</a>
TPS3705-33D	ACTIVE	SOIC	D	8	75	RoHS & Green	NIPDAU	Level-1-260C-UNLIM	-40 to 125	70533	<a href="#">Samples</a>
TPS3705-33DG4	ACTIVE	SOIC	D	8	75	RoHS & Green	NIPDAU	Level-1-260C-UNLIM	-40 to 125	70533	<a href="#">Samples</a>
TPS3705-33DGN	ACTIVE	HVSSOP	DGN	8	80	RoHS & Green	NIPDAU	Level-1-260C-UNLIM	-40 to 85	AAU	<a href="#">Samples</a>
TPS3705-33DGNR	ACTIVE	HVSSOP	DGN	8	2500	RoHS & Green	NIPDAU	Level-1-260C-UNLIM	-40 to 85	AAU	<a href="#">Samples</a>
TPS3705-33DR	ACTIVE	SOIC	D	8	2500	RoHS & Green	Call TI   NIPDAU	Level-1-260C-UNLIM	-40 to 125	70533	<a href="#">Samples</a>
TPS3705-50D	ACTIVE	SOIC	D	8	75	RoHS & Green	NIPDAU	Level-1-260C-UNLIM	-40 to 85	70550	<a href="#">Samples</a>
TPS3705-50DG4	ACTIVE	SOIC	D	8	75	RoHS & Green	NIPDAU	Level-1-260C-UNLIM	-40 to 85	70550	<a href="#">Samples</a>
TPS3705-50DGN	ACTIVE	HVSSOP	DGN	8	80	RoHS & Green	NIPDAU	Level-1-260C-UNLIM	-40 to 85	AAV	<a href="#">Samples</a>
TPS3705-50DGN4	ACTIVE	HVSSOP	DGN	8	80	RoHS & Green	NIPDAU	Level-1-260C-UNLIM	-40 to 85	AAV	<a href="#">Samples</a>
TPS3705-50DGNR	ACTIVE	HVSSOP	DGN	8	2500	RoHS & Green	NIPDAU	Level-1-260C-UNLIM	-40 to 85	AAV	<a href="#">Samples</a>
TPS3705-50DR	ACTIVE	SOIC	D	8	2500	RoHS & Green	NIPDAU	Level-1-260C-UNLIM	-40 to 85	70550	<a href="#">Samples</a>
TPS3705-50DRG4	ACTIVE	SOIC	D	8	2500	RoHS & Green	NIPDAU	Level-1-260C-UNLIM	-40 to 85	70550	<a href="#">Samples</a>
TPS3707-25D	ACTIVE	SOIC	D	8	75	RoHS & Green	NIPDAU	Level-1-260C-UNLIM	-40 to 85	70725	<a href="#">Samples</a>
TPS3707-25DGN	ACTIVE	HVSSOP	DGN	8	80	RoHS & Green	NIPDAU	Level-1-260C-UNLIM	-40 to 85	AAW	<a href="#">Samples</a>
TPS3707-25DGNR	ACTIVE	HVSSOP	DGN	8	2500	RoHS & Green	NIPDAU	Level-1-260C-UNLIM	-40 to 85	AAW	<a href="#">Samples</a>
TPS3707-25DR	ACTIVE	SOIC	D	8	2500	RoHS & Green	NIPDAU	Level-1-260C-UNLIM	-40 to 85	70725	<a href="#">Samples</a>
TPS3707-30D	ACTIVE	SOIC	D	8	75	RoHS & Green	NIPDAU	Level-1-260C-UNLIM	-40 to 85	70730	<a href="#">Samples</a>

Orderable Device	Status (1)	Package Type	Package Drawing	Pins	Package Qty	Eco Plan (2)	Lead finish/ Ball material (6)	MSL Peak Temp (3)	Op Temp (°C)	Device Marking (4/5)	Samples
TPS3707-30DG4	ACTIVE	SOIC	D	8	75	RoHS & Green	NIPDAU	Level-1-260C-UNLIM	-40 to 85	70730	<a href="#">Samples</a>
TPS3707-30DGN	ACTIVE	HVSSOP	DGN	8	80	RoHS & Green	NIPDAU	Level-1-260C-UNLIM	-40 to 85	AAX	<a href="#">Samples</a>
TPS3707-30DGNR	ACTIVE	HVSSOP	DGN	8	2500	RoHS & Green	NIPDAU	Level-1-260C-UNLIM	-40 to 85	AAX	<a href="#">Samples</a>
TPS3707-30DR	ACTIVE	SOIC	D	8	2500	RoHS & Green	NIPDAU	Level-1-260C-UNLIM	-40 to 85	70730	<a href="#">Samples</a>
TPS3707-33D	ACTIVE	SOIC	D	8	75	RoHS & Green	NIPDAU	Level-1-260C-UNLIM	-40 to 85	70733	<a href="#">Samples</a>
TPS3707-33DG4	ACTIVE	SOIC	D	8	75	RoHS & Green	NIPDAU	Level-1-260C-UNLIM	-40 to 85	70733	<a href="#">Samples</a>
TPS3707-33DGN	ACTIVE	HVSSOP	DGN	8	80	RoHS & Green	NIPDAU	Level-1-260C-UNLIM	-40 to 85	AAZ	<a href="#">Samples</a>
TPS3707-33DGNG4	ACTIVE	HVSSOP	DGN	8	80	RoHS & Green	NIPDAU	Level-1-260C-UNLIM	-40 to 85	AAZ	<a href="#">Samples</a>
TPS3707-33DGNR	ACTIVE	HVSSOP	DGN	8	2500	RoHS & Green	NIPDAU	Level-1-260C-UNLIM	-40 to 85	AAZ	<a href="#">Samples</a>
TPS3707-33DGNRG4	ACTIVE	HVSSOP	DGN	8	2500	RoHS & Green	NIPDAU	Level-1-260C-UNLIM	-40 to 85	AAZ	<a href="#">Samples</a>
TPS3707-33DR	ACTIVE	SOIC	D	8	2500	RoHS & Green	NIPDAU	Level-1-260C-UNLIM	-40 to 85	70733	<a href="#">Samples</a>
TPS3707-50D	ACTIVE	SOIC	D	8	75	RoHS & Green	NIPDAU	Level-1-260C-UNLIM	-40 to 85	70750	<a href="#">Samples</a>
TPS3707-50DGN	ACTIVE	HVSSOP	DGN	8	80	RoHS & Green	NIPDAU	Level-1-260C-UNLIM	-40 to 85	AAZ	<a href="#">Samples</a>
TPS3707-50DGNR	ACTIVE	HVSSOP	DGN	8	2500	RoHS & Green	NIPDAU	Level-1-260C-UNLIM	-40 to 85	AAZ	<a href="#">Samples</a>
TPS3707-50DR	ACTIVE	SOIC	D	8	2500	RoHS & Green	NIPDAU	Level-1-260C-UNLIM	-40 to 85	70750	<a href="#">Samples</a>

(1) The marketing status values are defined as follows:

**ACTIVE:** Product device recommended for new designs.

**LIFEBUY:** TI has announced that the device will be discontinued, and a lifetime-buy period is in effect.

**NRND:** Not recommended for new designs. Device is in production to support existing customers, but TI does not recommend using this part in a new design.

**PREVIEW:** Device has been announced but is not in production. Samples may or may not be available.

**OBSELETE:** TI has discontinued the production of the device.

(2) **RoHS:** TI defines "RoHS" to mean semiconductor products that are compliant with the current EU RoHS requirements for all 10 RoHS substances, including the requirement that RoHS substance do not exceed 0.1% by weight in homogeneous materials. Where designed to be soldered at high temperatures, "RoHS" products are suitable for use in specified lead-free processes. TI may reference these types of products as "Pb-Free".

**RoHS Exempt:** TI defines "RoHS Exempt" to mean products that contain lead but are compliant with EU RoHS pursuant to a specific EU RoHS exemption.



**Green:** TI defines "Green" to mean the content of Chlorine (Cl) and Bromine (Br) based flame retardants meet JS709B low halogen requirements of  $\leq 1000$ ppm threshold. Antimony trioxide based flame retardants must also meet the  $\leq 1000$ ppm threshold requirement.

(3) MSL, Peak Temp. - The Moisture Sensitivity Level rating according to the JEDEC industry standard classifications, and peak solder temperature.

(4) There may be additional marking, which relates to the logo, the lot trace code information, or the environmental category on the device.

(5) Multiple Device Markings will be inside parentheses. Only one Device Marking contained in parentheses and separated by a "~" will appear on a device. If a line is indented then it is a continuation of the previous line and the two combined represent the entire Device Marking for that device.

(6) Lead finish/Ball material - Orderable Devices may have multiple material finish options. Finish options are separated by a vertical ruled line. Lead finish/Ball material values may wrap to two lines if the finish value exceeds the maximum column width.

**Important Information and Disclaimer:** The information provided on this page represents TI's knowledge and belief as of the date that it is provided. TI bases its knowledge and belief on information provided by third parties, and makes no representation or warranty as to the accuracy of such information. Efforts are underway to better integrate information from third parties. TI has taken and continues to take reasonable steps to provide representative and accurate information but may not have conducted destructive testing or chemical analysis on incoming materials and chemicals. TI and TI suppliers consider certain information to be proprietary, and thus CAS numbers and other limited information may not be available for release.

In no event shall TI's liability arising out of such information exceed the total purchase price of the TI part(s) at issue in this document sold by TI to Customer on an annual basis.

## TAPE AND REEL INFORMATION



### QUADRANT ASSIGNMENTS FOR PIN 1 ORIENTATION IN TAPE



\*All dimensions are nominal

Device	Package Type	Package Drawing	Pins	SPQ	Reel Diameter (mm)	Reel Width W1 (mm)	A0 (mm)	B0 (mm)	K0 (mm)	P1 (mm)	W (mm)	Pin1 Quadrant
TPS3705-30DR	SOIC	D	8	2500	330.0	12.4	6.4	5.2	2.1	8.0	12.0	Q1
TPS3705-33DGNR	HVSSOP	DGN	8	2500	330.0	12.4	5.3	3.4	1.4	8.0	12.0	Q1
TPS3705-33DR	SOIC	D	8	2500	330.0	12.4	6.4	5.2	2.1	8.0	12.0	Q1
TPS3705-50DGNR	HVSSOP	DGN	8	2500	330.0	12.4	5.3	3.4	1.4	8.0	12.0	Q1
TPS3705-50DR	SOIC	D	8	2500	330.0	12.4	6.4	5.2	2.1	8.0	12.0	Q1
TPS3707-25DGNR	HVSSOP	DGN	8	2500	330.0	12.4	5.3	3.4	1.4	8.0	12.0	Q1
TPS3707-25DR	SOIC	D	8	2500	330.0	12.4	6.4	5.2	2.1	8.0	12.0	Q1
TPS3707-30DGNR	HVSSOP	DGN	8	2500	330.0	12.4	5.3	3.4	1.4	8.0	12.0	Q1
TPS3707-30DR	SOIC	D	8	2500	330.0	12.4	6.4	5.2	2.1	8.0	12.0	Q1
TPS3707-33DGNR	HVSSOP	DGN	8	2500	330.0	12.4	5.3	3.4	1.4	8.0	12.0	Q1
TPS3707-33DR	SOIC	D	8	2500	330.0	12.4	6.4	5.2	2.1	8.0	12.0	Q1
TPS3707-50DGNR	HVSSOP	DGN	8	2500	330.0	12.4	5.3	3.4	1.4	8.0	12.0	Q1
TPS3707-50DR	SOIC	D	8	2500	330.0	12.4	6.4	5.2	2.1	8.0	12.0	Q1

**TAPE AND REEL BOX DIMENSIONS**

\*All dimensions are nominal

Device	Package Type	Package Drawing	Pins	SPQ	Length (mm)	Width (mm)	Height (mm)
TPS3705-30DR	SOIC	D	8	2500	350.0	350.0	43.0
TPS3705-33DGNR	HVSSOP	DGN	8	2500	358.0	335.0	35.0
TPS3705-33DR	SOIC	D	8	2500	350.0	350.0	43.0
TPS3705-50DGNR	HVSSOP	DGN	8	2500	358.0	335.0	35.0
TPS3705-50DR	SOIC	D	8	2500	350.0	350.0	43.0
TPS3707-25DGNR	HVSSOP	DGN	8	2500	358.0	335.0	35.0
TPS3707-25DR	SOIC	D	8	2500	350.0	350.0	43.0
TPS3707-30DGNR	HVSSOP	DGN	8	2500	358.0	335.0	35.0
TPS3707-30DR	SOIC	D	8	2500	356.0	356.0	35.0
TPS3707-33DGNR	HVSSOP	DGN	8	2500	358.0	335.0	35.0
TPS3707-33DR	SOIC	D	8	2500	350.0	350.0	43.0
TPS3707-50DGNR	HVSSOP	DGN	8	2500	358.0	335.0	35.0
TPS3707-50DR	SOIC	D	8	2500	350.0	350.0	43.0

**TUBE**

\*All dimensions are nominal

Device	Package Name	Package Type	Pins	SPQ	L (mm)	W (mm)	T (μm)	B (mm)
TPS3705-30D	D	SOIC	8	75	506.6	8	3940	4.32
TPS3705-30D	D	SOIC	8	75	505.46	6.76	3810	4
TPS3705-33D	D	SOIC	8	75	505.46	6.76	3810	4
TPS3705-33DG4	D	SOIC	8	75	505.46	6.76	3810	4
TPS3705-50D	D	SOIC	8	75	505.46	6.76	3810	4
TPS3705-50DG4	D	SOIC	8	75	505.46	6.76	3810	4
TPS3707-25D	D	SOIC	8	75	505.46	6.76	3810	4
TPS3707-30D	D	SOIC	8	75	505.46	6.76	3810	4
TPS3707-30D	D	SOIC	8	75	506.6	8	3940	4.32
TPS3707-30DG4	D	SOIC	8	75	505.46	6.76	3810	4
TPS3707-30DG4	D	SOIC	8	75	506.6	8	3940	4.32
TPS3707-33D	D	SOIC	8	75	505.46	6.76	3810	4
TPS3707-33DG4	D	SOIC	8	75	505.46	6.76	3810	4
TPS3707-50D	D	SOIC	8	75	505.46	6.76	3810	4

## GENERIC PACKAGE VIEW

**DGN 8**

**PowerPAD VSSOP - 1.1 mm max height**

3 x 3, 0.65 mm pitch

SMALL OUTLINE PACKAGE

This image is a representation of the package family, actual package may vary.  
Refer to the product data sheet for package details.



4225482/A



PowerPAD is a trademark of Texas Instruments.

NOTES:

1. All linear dimensions are in millimeters. Any dimensions in parenthesis are for reference only. Dimensioning and tolerancing per ASME Y14.5M.
2. This drawing is subject to change without notice.
3. This dimension does not include mold flash, protrusions, or gate burrs. Mold flash, protrusions, or gate burrs shall not exceed 0.15 mm per side.
4. This dimension does not include interlead flash. Interlead flash shall not exceed 0.25 mm per side.
5. Reference JEDEC registration MO-187.

# EXAMPLE BOARD LAYOUT

DGN0008D

PowerPAD™ VSSOP - 1.1 mm max height

SMALL OUTLINE PACKAGE



LAND PATTERN EXAMPLE  
EXPOSED METAL SHOWN  
SCALE: 15X



SOLDER MASK DETAILS

4225481/A 11/2019

NOTES: (continued)

6. Publication IPC-7351 may have alternate designs.
7. Solder mask tolerances between and around signal pads can vary based on board fabrication site.
8. Vias are optional depending on application, refer to device data sheet. If any vias are implemented, refer to their locations shown on this view. It is recommended that vias under paste be filled, plugged or tented.
9. Size of metal pad may vary due to creepage requirement.

# EXAMPLE STENCIL DESIGN

DGN0008D

PowerPAD™ VSSOP - 1.1 mm max height

SMALL OUTLINE PACKAGE



**SOLDER PASTE EXAMPLE**  
EXPOSED PAD 9:  
100% PRINTED SOLDER COVERAGE BY AREA  
SCALE: 15X

STENCIL THICKNESS	SOLDER STENCIL OPENING
0.1	1.76 X 2.11
0.125	1.57 X 1.89 (SHOWN)
0.15	1.43 X 1.73
0.175	1.33 X 1.60

4225481/A 11/2019

NOTES: (continued)

10. Laser cutting apertures with trapezoidal walls and rounded corners may offer better paste release. IPC-7525 may have alternate design recommendations.
11. Board assembly site may have different recommendations for stencil design.





D0008A

# PACKAGE OUTLINE

SOIC - 1.75 mm max height

SMALL OUTLINE INTEGRATED CIRCUIT



4214825/C 02/2019

NOTES:

1. Linear dimensions are in inches [millimeters]. Dimensions in parenthesis are for reference only. Controlling dimensions are in inches. Dimensioning and tolerancing per ASME Y14.5M.
2. This drawing is subject to change without notice.
3. This dimension does not include mold flash, protrusions, or gate burrs. Mold flash, protrusions, or gate burrs shall not exceed  $.006$  [0.15] per side.
4. This dimension does not include interlead flash.
5. Reference JEDEC registration MS-012, variation AA.

# EXAMPLE BOARD LAYOUT

D0008A

SOIC - 1.75 mm max height

SMALL OUTLINE INTEGRATED CIRCUIT



LAND PATTERN EXAMPLE  
 EXPOSED METAL SHOWN  
 SCALE:8X



SOLDER MASK DETAILS

4214825/C 02/2019

NOTES: (continued)

- 6. Publication IPC-7351 may have alternate designs.
- 7. Solder mask tolerances between and around signal pads can vary based on board fabrication site.

# EXAMPLE STENCIL DESIGN

D0008A

SOIC - 1.75 mm max height

SMALL OUTLINE INTEGRATED CIRCUIT



SOLDER PASTE EXAMPLE  
BASED ON .005 INCH [0.125 MM] THICK STENCIL  
SCALE:8X

4214825/C 02/2019

NOTES: (continued)

8. Laser cutting apertures with trapezoidal walls and rounded corners may offer better paste release. IPC-7525 may have alternate design recommendations.
9. Board assembly site may have different recommendations for stencil design.

## 重要声明和免责声明

TI“按原样”提供技术和可靠性数据（包括数据表）、设计资源（包括参考设计）、应用或其他设计建议、网络工具、安全信息和其他资源，不保证没有瑕疵且不做任何明示或暗示的担保，包括但不限于对适销性、某特定用途方面的适用性或不侵犯任何第三方知识产权的暗示担保。

这些资源可供使用 TI 产品进行设计的熟练开发人员使用。您将自行承担以下全部责任：(1) 针对您的应用选择合适的 TI 产品，(2) 设计、验证并测试您的应用，(3) 确保您的应用满足相应标准以及任何其他功能安全、信息安全、监管或其他要求。

这些资源如有变更，恕不另行通知。TI 授权您仅可将这些资源用于研发本资源所述的 TI 产品的应用。严禁对这些资源进行其他复制或展示。您无权使用任何其他 TI 知识产权或任何第三方知识产权。您应全额赔偿因在这些资源的使用中对 TI 及其代表造成的任何索赔、损害、成本、损失和债务，TI 对此概不负责。

TI 提供的产品受 [TI 的销售条款](#) 或 [ti.com](#) 上其他适用条款/TI 产品随附的其他适用条款的约束。TI 提供这些资源并不会扩展或以其他方式更改 TI 针对 TI 产品发布的适用的担保或担保免责声明。

TI 反对并拒绝您可能提出的任何其他或不同的条款。

邮寄地址：Texas Instruments, Post Office Box 655303, Dallas, Texas 75265

Copyright © 2023，德州仪器 (TI) 公司