

# 采用 1.2mm x 0.8mm 晶圆芯片级封装且适用于嵌入式应用的 TPS62088 和 TPS6208xA 2.4V 至 5.5V 输入电压、微型 6 引脚 2A/3A 降压转换器

## 1 特性

- DCS-Control 拓扑
- 效率高达 95%
- 26mΩ 和 26mΩ 内部功率 MOSFET
- 2.4V 至 5.5V 输入电压范围
- 4 μA 工作静态电流
- 1% 的输出电压精度
- 4MHz 开关频率
- 可实现轻负载效率的省电模式
- 强制 PWM 版本可支持 CCM 运行
- 可实现最低压降的 100% 占空比
- 有源输出放电
- 电源正常状态输出
- 热关断保护
- 断续短路保护
- 采用间距为 0.4mm 的 6 引脚 WCSP 和 PowerWCSP 封装
- 0.3mm 高的 YWC 封装支持嵌入式系统
- 支持 12mm<sup>2</sup> 的解决方案尺寸
- 支持高度小于 0.6mm 的解决方案
- 使用 TPS62088 并借助 [WEBENCH® Power Designer](#) 创建定制设计方案

## 2 应用

- 固态硬盘
- 可穿戴产品
- 智能手机
- 摄像头模块
- 光学模块

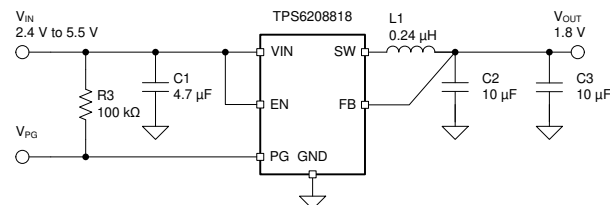

Copyright © 2017, Texas Instruments Incorporated

典型应用原理图

## 3 说明

TPS6208xx 器件系列是一种高频同步降压转换器，经优化具有小解决方案尺寸和高效率。该器件的输入电压范围为 2.4V 至 5.5V，支持常用电池技术。该转换器在中高负载条件下以 PWM 模式运行，并在轻负载时自动进入省电模式运行，从而在整个负载电流范围内保持高效率。器件的强制 PWM 版本可在任意负载上维持 CCM 运行。4MHz 的开关频率允许该器件使用小型外部组件。该器件可同时实现 DCS-Control 架构、出色的负载瞬态性能和输出稳压精度。内置的其他特性包括过流保护、热关断保护、有源输出放电和电源正常。该器件采用 6 引脚 WCSP 封装。

### 器件信息

器件型号	封装 <sup>(1)</sup>	封装尺寸 (标称值)
TPS62088	YFP (6)	0.8mm × 1.2mm × 0.5mm
TPS62089A		
TPS62088A	YWC (6)	0.8mm × 1.2mm × 0.3mm

(1) 如需了解所有可用封装，请参阅产品说明书末尾的可订购产品附录。

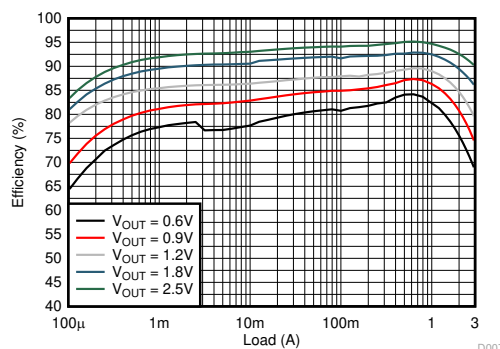

3.3V 输入电压效率

D007



## Table of Contents

<b>1 特性</b> .....	<b>1</b>	<b>9 Application and Implementation</b> .....	<b>10</b>
<b>2 应用</b> .....	<b>1</b>	9.1 Application Information.....	10
<b>3 说明</b> .....	<b>1</b>	9.2 Typical Application.....	10
<b>4 Revision History</b> .....	<b>2</b>	<b>10 Power Supply Recommendations</b> .....	<b>19</b>
<b>5 Device Options</b> .....	<b>3</b>	<b>11 Layout</b> .....	<b>20</b>
<b>6 Pin Configuration and Functions</b> .....	<b>3</b>	11.1 Layout Guidelines.....	20
<b>7 Specifications</b> .....	<b>4</b>	11.2 Layout Example.....	20
7.1 Absolute Maximum Ratings .....	4	<b>12 Device and Documentation Support</b> .....	<b>21</b>
7.2 ESD Ratings .....	4	12.1 Device Support.....	21
7.3 Recommended Operating Conditions .....	4	12.2 Documentation Support.....	21
7.4 Thermal Information .....	4	12.3 接收文档更新通知.....	21
7.5 Electrical Characteristics .....	5	12.4 支持资源.....	21
7.6 Typical Characteristics.....	6	12.5 Trademarks.....	21
<b>8 Detailed Description</b> .....	<b>7</b>	12.6 Electrostatic Discharge Caution.....	21
8.1 Overview.....	7	12.7 术语表.....	22
8.2 Functional Block Diagram.....	7	<b>13 Mechanical, Packaging, and Orderable</b>	
8.3 Feature Description.....	7	<b>Information</b> .....	<b>22</b>
8.4 Device Functional Modes.....	9		

## 4 Revision History

注：以前版本的页码可能与当前版本的页码不同

<b>Changes from Revision D (September 2019) to Revision E (November 2021)</b>	<b>Page</b>
• 更新了整个文档中的表格、图和交叉参考的编号格式.....	1
• Added information for the FPWM devices.....	3
• Added new curves for FPWM devices.....	14

---

<b>Changes from Revision C (May 2019) to Revision D (September 2019)</b>	<b>Page</b>
• 将 TPS62088YWC 状态更改为“量产” .....	1
• Added TPS62088YWCEVM-084 to the Thermal information table.....	4

## 5 Device Options

Device Options		
PART NUMBER <sup>(1)</sup>	OPERATION MODE	OUTPUT VOLTAGE
TPS62088YFP	PFM/PWM	3-A adjustable
TPS62088YWC	PFM/PWM	3-A adjustable
TPS6208812YFP	PFM/PWM	3 A with 1.2 V
TPS6208818YFP	PFM/PWM	3 A with 1.8 V
TPS6208833YFP	PFM/PWM	3 A with 3.3 V
TPS62088AYFP	Forced-PWM	3-A adjustable
TPS62089AYFP	Forced-PWM	2-A adjustable

(1) For detailed ordering information, please check the package option addendum section at the end of this data sheet.

## 6 Pin Configuration and Functions



图 6-1. YFP Package Top View



图 6-2. YWC Package Top View

表 6-1. Pin Functions

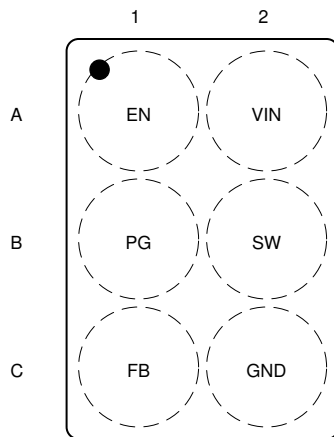
PIN		I/O	DESCRIPTION
NAME	NO.		
EN	A1	I	Device enable pin. To enable the device, this pin needs to be pulled high. Pulling this pin low disables the device. Do not leave floating.
PG	B1	O	Power-good open-drain output pin. The pullup resistor can be connected to voltages up to 5.5 V. If unused, leave it floating.
FB	C1	I	Feedback pin. For the fixed output voltage versions, this pin must be connected to the output.
GND	C2	—	Ground pin
SW	B2	O	Switch pin of the power stage
VIN	A2	I	Input voltage pin

## 7 Specifications

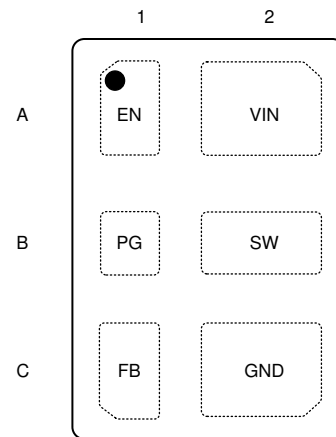
### 7.1 Absolute Maximum Ratings

		MIN	MAX	UNIT
Voltage at pins <sup>(2)</sup>	VIN, FB, EN, PG	- 0.3	6	V
	SW (DC)	- 0.3	V <sub>IN</sub> + 0.3	
	SW (DC, in current limit)	- 1.0	V <sub>IN</sub> + 0.3	
	SW (AC, less than 10 ns) <sup>(3)</sup>	- 2.5	10	
Temperature	Operating junction temperature, T <sub>J</sub>	- 40	150	°C
	Storage temperature, T <sub>stg</sub>	- 65	150	

- Stresses beyond those listed under Absolute Maximum Ratings may cause permanent damage to the device. These are stress ratings only and functional operation of the device at these or any other conditions beyond those indicated under Recommended Operating Conditions is not implied. Exposure to absolute-maximum-rated conditions for extended periods may affect device reliability.
- All voltage values are with respect to network ground terminal.
- While switching.

### 7.2 ESD Ratings

			VALUE	UNIT
V <sub>(ESD)</sub>	Electrostatic discharge	Human-body model (HBM), per ANSI/ESDA/JEDEC JS-001 <sup>(1)</sup>	±2000	V
		Charged-device model (CDM), per JEDEC specification JESD22-C101 <sup>(2)</sup>	±500	V

- JEDEC document JEP155 states that 500-V HBM allows safe manufacturing with a standard ESD control process.
- JEDEC document JEP157 states that 250-V CDM allows safe manufacturing with a standard ESD control process.

### 7.3 Recommended Operating Conditions

Over operating junction temperature range (unless otherwise noted)

		MIN	NOM	MAX	UNIT
V <sub>IN</sub>	Input voltage range	2.4		5.5	V
V <sub>OUT</sub>	Output voltage range	0.6		4.0	V
I <sub>OUT</sub>	Output current range, TPS62089A	0		2	A
I <sub>OUT</sub>	Output current range, TPS62088, TPS62088A <sup>(1)</sup>	0		3	A
I <sub>SINK_PG</sub>	Sink current at the PG pin			1	mA
V <sub>PG</sub>	Pullup resistor voltage			5.5	V
T <sub>J</sub>	Operating junction temperature	-40		125	°C

- For YFP package versions, lifetime is reduced when operating continuously at 3-A output current with the junction temperature higher than 85°C.

### 7.4 Thermal Information

THERMAL METRIC <sup>(1)</sup>		TPS62088/TPS6208xA				UNIT
		6 PINS				
		YFP (6 PINS)	YWC (6 PINS)	YFP EVM-814	YWC EVM-084	
R <sub>θJA</sub>	Junction-to-ambient thermal resistance	141.3	130.9	85.7	70.6	°C/W
R <sub>θJC(top)</sub>	Junction-to-case (top) thermal resistance	1.7	1.1	n/a <sup>(2)</sup>	n/a <sup>(2)</sup>	°C/W
R <sub>θJB</sub>	Junction-to-board thermal resistance	47.3	27.3	n/a <sup>(2)</sup>	n/a <sup>(2)</sup>	°C/W
ψ <sub>JT</sub>	Junction-to-top characterization parameter	0.5	0.7	1.9	0.5	°C/W
ψ <sub>JB</sub>	Junction-to-board characterization parameter	47.5	27.2	55.9	38.7	°C/W

- For more information about traditional and new thermal metrics, see the [Semiconductor and IC Package Thermal Metrics](#) application report.
- Not applicable to an EVM.

## 7.5 Electrical Characteristics

$T_J = -40^{\circ}\text{C}$  to  $125^{\circ}\text{C}$ , and  $V_{IN} = 2.4\text{ V}$  to  $5.5\text{ V}$ . Typical values are at  $T_J = 25^{\circ}\text{C}$  and  $V_{IN} = 5\text{ V}$ , unless otherwise noted.

PARAMETER		TEST CONDITIONS	MIN	TYP	MAX	UNIT
<b>SUPPLY</b>						
$I_Q$	Quiescent current	EN = HIGH, no load, device not switching		4	10	$\mu\text{A}$
$I_Q$	Quiescent current	EN = HIGH, no load, TPS62088A and TPS62089A		8		$\text{mA}$
$I_{SD}$	Shutdown current	EN = LOW, $T_J = -40^{\circ}\text{C}$ to $85^{\circ}\text{C}$		0.05	0.5	$\mu\text{A}$
$V_{UVLO}$	Undervoltage lockout threshold	$V_{IN}$ falling	2.1	2.2	2.3	$\text{V}$
	Undervoltage lockout hysteresis	$V_{IN}$ rising		160		$\text{mV}$
$T_{JSD}$	Thermal shutdown threshold	$T_J$ rising		150		$^{\circ}\text{C}$
	Thermal shutdown hysteresis	$T_J$ falling		20		$^{\circ}\text{C}$
<b>LOGIC INTERFACE EN</b>						
$V_{IH}$	High-level input threshold voltage		1.0			$\text{V}$
$V_{IL}$	Low-level input threshold voltage				0.4	$\text{V}$
$I_{EN,LKG}$	Input leakage current into EN pin			0.01	0.1	$\mu\text{A}$
<b>SOFT START, POWER GOOD</b>						
$t_{SS}$	Soft-start time	Time from EN high to 95% of $V_{OUT}$ nominal		1.25		$\text{ms}$
$V_{PG}$	Power-good lower threshold	$V_{PG}$ rising, $V_{FB}$ referenced to $V_{FB}$ nominal	94%	96%	98%	
		$V_{PG}$ falling, $V_{FB}$ referenced to $V_{FB}$ nominal	90%	92%	94%	
	Power-good upper threshold	$V_{PG}$ rising, $V_{FB}$ referenced to $V_{FB}$ nominal	103%	105%	107%	
		$V_{PG}$ falling, $V_{FB}$ referenced to $V_{FB}$ nominal	108%	110%	112%	
$V_{PG,OL}$	Low-level output voltage	$I_{sink} = 1\text{ mA}$			0.4	$\text{V}$
$I_{PG,LKG}$	Input leakage current into PG pin	$V_{PG} = 5.0\text{ V}$		0.01	0.1	$\mu\text{A}$
<b>OUTPUT</b>						
$V_{OUT}$	Output voltage accuracy	TPS6208812, PWM mode	1.188	1.2	1.212	$\text{V}$
		TPS6208818, PWM mode	1.782	1.8	1.818	
		TPS6208833, PWM mode	3.267	3.3	3.333	
$V_{FB}$	Feedback regulation voltage	PWM mode	594	600	606	$\text{mV}$
$I_{FB,LKG}$	Feedback input leakage current	TPS62088, $V_{FB} = 0.6\text{ V}$		0.01	0.05	$\mu\text{A}$
$R_{FB}$	Internal resistor divider connected to FB pin	TPS6208812, TPS6208818, TPS6208833		7.5		$\text{M}\Omega$
$I_{DIS}$	Output discharge current	$V_{SW} = 0.4\text{ V}$ ; EN = LOW	75	400		$\text{mA}$
<b>POWER SWITCH</b>						
$R_{DS(on)}$	High-side FET on-resistance			26		$\text{m}\Omega$
	Low-side FET on-resistance			26		$\text{m}\Omega$
$I_{LIM}$	High-side FET switch current limit	TPS62089A	2.7	3.3	3.9	$\text{A}$
$I_{LIM}$	High-side FET switch current limit	TPS62088 and TPS62088A	3.6	4.3	5.0	$\text{A}$
$I_{LIM}$	Low-side FET switch negative current limit	TPS62088A and TPS62089A		-1.6		$\text{A}$
$f_{SW}$	PWM switching frequency	$I_{OUT} = 1\text{ A}$ , $V_{OUT} = 1.8\text{ V}$		4		$\text{MHz}$

## 7.6 Typical Characteristics



图 7-1. High-Side FET On-Resistance



图 7-2. Low-Side FET On-Resistance

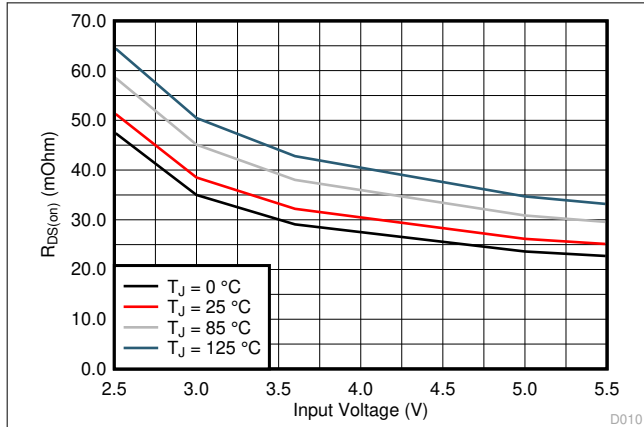

图 7-3. Quiescent Current

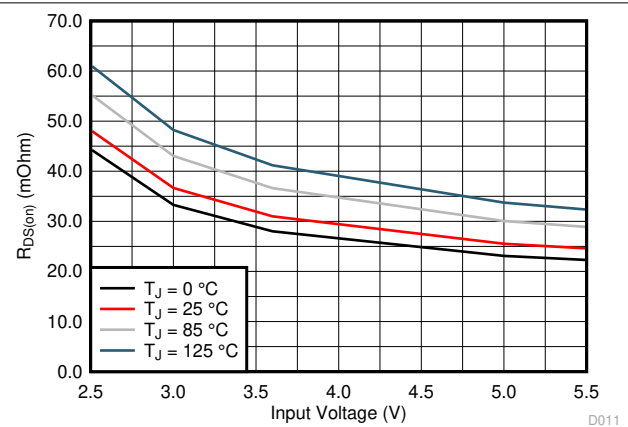

图 7-4. Shutdown Current

## 8 Detailed Description

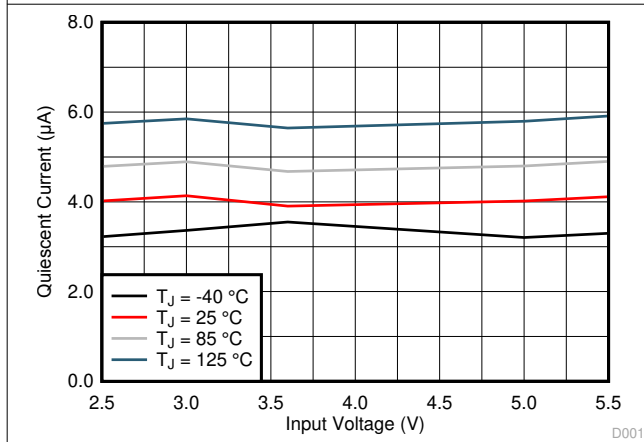
### 8.1 Overview

The TPS62088xx family is synchronous step-down converter that adopts a new generation DCS-Control (Direct Control with Seamless transition into power save mode) topology without the output voltage sense (VOS) pin. This is an advanced regulation topology that combines the advantages of hysteretic, voltage, and current mode control schemes.

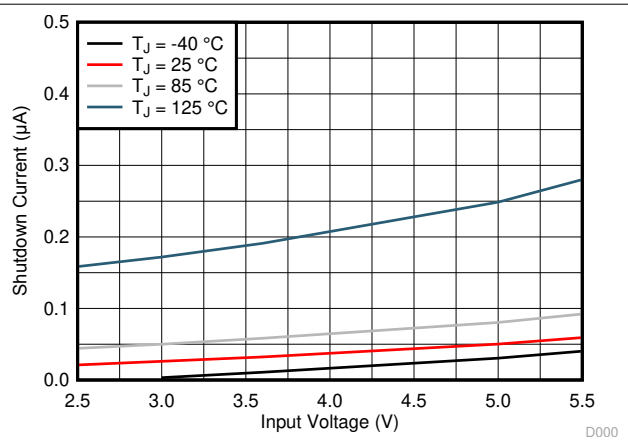
The DCS-Control topology operates in PWM (pulse width modulation) mode for medium to heavy load conditions and in power save mode at light load currents. In PWM mode, the converter operates with its nominal switching frequency of 4 MHz, having a controlled frequency variation over the input voltage range. As the load current decreases, the converter enters Power Save Mode, reducing the switching frequency and minimizing the IC current consumption to achieve high efficiency over the entire load current range. In forced PWM devices, the converter maintains a continuous conduction mode operation and keeps the output voltage ripple very low across the whole load range and at a nominal switching frequency of 4 MHz. Because DCS-Control supports both operation modes (PWM and PFM) within a single building block, the transition from PWM mode to power save mode is seamless and without effects on the output voltage. The devices offer both excellent DC voltage and superior load transient regulation, combined with very low output voltage ripple, minimizing interference with RF circuits.

### 8.2 Functional Block Diagram

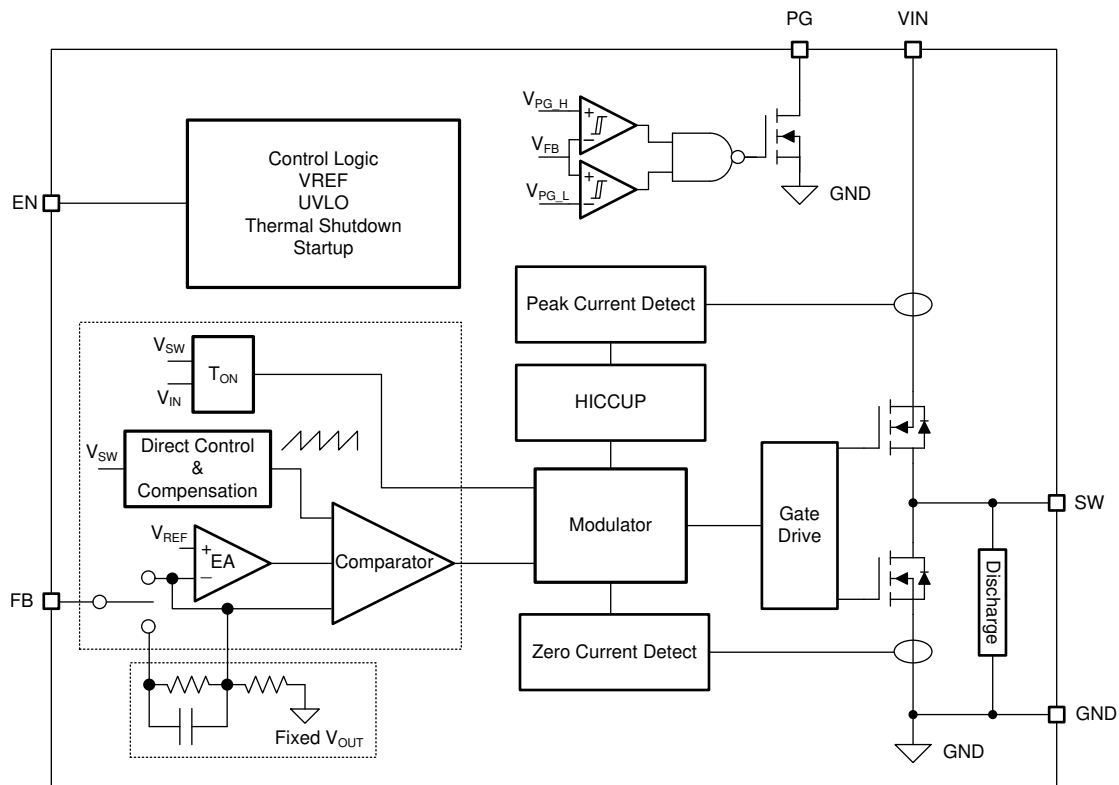

### 8.3 Feature Description

#### 8.3.1 Power Save Mode

As the load current decreases, the device enters power save mode operation. The power save mode occurs when the inductor current becomes discontinuous. Power save mode is based on a fixed on-time architecture, as related in [方程式 1](#).

$$t_{ON} = 250\text{ns} \times \frac{V_{OUT}}{V_{IN}} \quad (1)$$

In power save mode, the output voltage rises slightly above the nominal output voltage. This effect is minimized by increasing the output capacitor or inductor value.

When the device operates close to 100% duty cycle mode, the device cannot enter power save mode regardless of the load current if the input voltage decreases to typically 10% above the output voltage. The device maintains output regulation in PWM mode.

### 8.3.2 Pulse Width Modulation (PWM) Operation

At load currents larger than half the inductor ripple current, the device operates in pulse width modulation in continuous conduction mode (CCM). The PWM operation is based on an adaptive constant on-time control with stabilized switching frequency.

In forced-PWM devices, the device always operates in pulse width modulation in continuous conduction mode (CCM).

### 8.3.3 100% Duty Cycle Low Dropout Operation

The devices offer low input-to-output voltage difference by entering 100% duty cycle mode. In this mode, the high-side MOSFET switch is constantly turned on and the low-side MOSFET is switched off. This is particularly useful in battery powered applications to achieve the longest operation time by taking full advantage of the whole battery voltage range. The minimum input voltage to maintain output regulation, depending on the load current and output voltage can be calculated as:

$$V_{IN,MIN} = V_{OUT} + I_{OUT,MAX} \times (R_{DS(on)} + R_L) \quad (2)$$

where

- $V_{IN,MIN}$  = Minimum input voltage to maintain an output voltage
- $I_{OUT,MAX}$  = Maximum output current
- $R_{DS(on)}$  = High-side FET ON-resistance
- $R_L$  = Inductor ohmic resistance (DCR)

### 8.3.4 Soft Start

After enabling the device, there is a 250- $\mu$ s delay before switching starts. Then, an internal soft start-up circuitry ramps up the output voltage which reaches nominal output voltage during the start-up time of 1 ms. This avoids excessive inrush current and creates a smooth output voltage rise slope. It also prevents excessive voltage drops of primary cells and rechargeable batteries with high internal impedance.

The device is able to start into a pre-biased output capacitor. It starts with the applied bias voltage and ramps the output voltage to its nominal value.

### 8.3.5 Switch Current Limit and HICCUP Short-Circuit Protection

The switch current limit prevents the device from high inductor current and from drawing excessive current from the battery or input voltage rail. Excessive current might occur with a shorted or saturated inductor or a heavy load or shorted output circuit condition. If the inductor current reaches the threshold  $I_{LIM}$ , the high-side MOSFET is turned off and the low-side MOSFET remains off, while the inductor current flows through its body diode and quickly ramps down.

When this switch current limits is triggered 32 times, the device stops switching. The device then automatically starts a new start-up after a typical delay time of 128  $\mu$ s has passed. This is named HICCUP short-circuit protection. The device repeats this mode until the high load condition disappears.



In forced PWM devices, a negative current limit (ILIMN) is enabled to prevent excessive current flowing backwards to the input. When the inductor current reaches ILIMN, the low-side MOSFET turns off and the highside MOSFET turns on and kept on until TON time expires.

### 8.3.6 Undervoltage Lockout

To avoid mis-operation of the device at low input voltages, undervoltage lockout is implemented that shuts down the device at voltages lower than  $V_{UVLO}$ .

### 8.3.7 Thermal Shutdown

The device goes into thermal shutdown and stops the power stage switching when the junction temperature exceeds  $T_{JSD}$ . When the device temperature falls below the threshold by 20°C, the device returns to normal operation automatically by switching the power stage again.

## 8.4 Device Functional Modes

### 8.4.1 Enable and Disable

The device is enabled by setting the EN pin to a logic HIGH. Accordingly, shutdown mode is forced if the EN pin is pulled LOW with a shutdown current of typically 50 nA. In shutdown mode, the internal power switches as well as the entire control circuitry are turned off. An internal switch smoothly discharges the output through the SW pin in shutdown mode. Do not leave the EN pin floating.

The typical threshold value of the EN pin is 0.89 V for rising input signal, and 0.62 V for falling input signal.

### 8.4.2 Power Good

The device has a power-good output. The PG pin goes high impedance once the FB pin voltage is above 96% and less than 105% of the nominal voltage, and is driven low once the voltage falls below typically 92% or higher than 110% of the nominal voltage. The PG pin is an open-drain output and is specified to sink up to 1 mA. The power-good output requires a pullup resistor connecting to any voltage rail less than 5.5 V.

The PG signal can be used for sequencing of multiple rails by connecting it to the EN pin of other converters. Leave the PG pin unconnected when not used. The PG rising edge has a 100- $\mu$ s blanking time and the PG falling edge has a deglitch delay of 20  $\mu$ s.

表 8-1. PG Pin Logic

DEVICE CONDITIONS		LOGIC STATUS	
		HIGH IMPEDANCE	LOW
Enable	EN = HIGH, $V_{FB} \geq 0.576$ V	✓	
	EN = HIGH, $V_{FB} \leq 0.552$ V		✓
	EN = HIGH, $V_{FB} \leq 0.63$ V	✓	
	EN = HIGH, $V_{FB} \geq 0.66$ V		✓
Shutdown	EN = LOW		✓
Thermal shutdown	$T_J > T_{JSD}$		✓
UVLO	$0.7$ V < $V_{IN}$ < $V_{UVLO}$		✓
Power supply removal	$V_{IN} < 0.7$ V	undefined	

## 9 Application and Implementation

### Note

以下应用部分中的信息不属于 TI 器件规格的范围，TI 不担保其准确性和完整性。TI 的客户应负责确定器件是否适用于其应用。客户应验证并测试其设计，以确保系统功能。

### 9.1 Application Information

The following section discusses the design of the external components to complete the power supply design for several input and output voltage options by using typical applications as a reference.

### 9.2 Typical Application

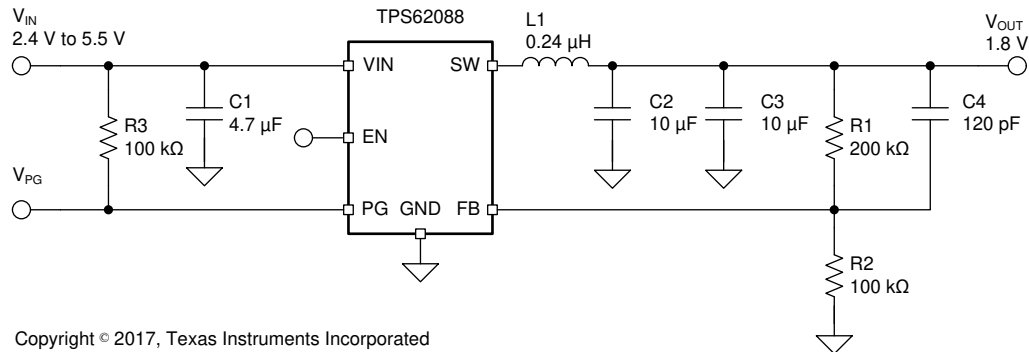

Copyright © 2017, Texas Instruments Incorporated

图 9-1. Typical Application of Adjustable Output

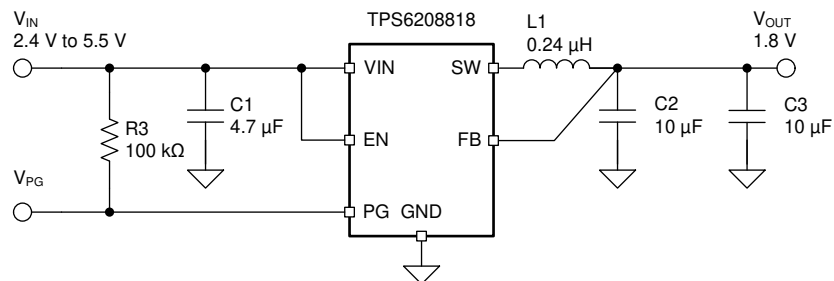

Copyright © 2017, Texas Instruments Incorporated

图 9-2. Typical Application of Fixed Output

#### 9.2.1 Design Requirements

For this design example, use the parameters listed in 表 9-1 as the input parameters.

表 9-1. Design Parameters

DESIGN PARAMETER	EXAMPLE VALUE
Input voltage	2.4 V to 5.5 V
Output voltage	1.8 V
Maximum peak output current	3 A

表 9-2 lists the components used for the example.

**表 9-2. List of Components of 图 9-1**

REFERENCE	DESCRIPTION	MANUFACTURER <sup>(1)</sup>
C1	4.7 μF, Ceramic capacitor, 6.3 V, X7R, size 0603, JMK107BB7475MA	Taiyo Yuden
C2, C3	10 μF, Ceramic capacitor, 10 V, X7R, size 0603, GRM188Z71A106MA73D	Murata
C4	120 pF, Ceramic capacitor, 50 V, size 0603, GRM1885C1H121JA01D	Murata
L1	0.24 μH, Power Inductor, size 0603, DFE160810S-R24M (DFE18SANR24MG0)	Murata
R1	Depending on the output voltage, 1%, size 0603	Std
R2	100 kΩ, Chip resistor, 1/16 W, 1%, size 0603	Std
R3	100 kΩ, Chip resistor, 1/16 W, 1%, size 0603	Std

(1) See [Third-party Products](#) disclaimer.

**表 9-3. List of Components of 图 9-2, Smallest Solution**

REFERENCE	DESCRIPTION	MANUFACTURER <sup>(1)</sup>
C1, C2, C3	10 μF, Ceramic capacitor, 6.3 V, X5R, size 0402, GRM155R60J106ME47	Murata
L1	0.24 μH, Power Inductor, size 0603, DFE160810S-R24M (DFE18SANR24MG0)	Murata
R3	100 kΩ, Chip resistor, 1/16 W, size 0402	Std

(1) See [Third-party Products](#) disclaimer.

## 9.2.2 Detailed Design Procedure

### 9.2.2.1 Custom Design With WEBENCH® Tools

[Click here](#) to create a custom design using the TPS62088 device with the WEBENCH® Power Designer.

1. Start by entering the input voltage ( $V_{IN}$ ), output voltage ( $V_{OUT}$ ), and output current ( $I_{OUT}$ ) requirements.
2. Optimize the design for key parameters such as efficiency, footprint, and cost using the optimizer dial.
3. Compare the generated design with other possible solutions from Texas Instruments.

The WEBENCH Power Designer provides a customized schematic along with a list of materials with real-time pricing and component availability.

In most cases, these actions are available:

- Run electrical simulations to see important waveforms and circuit performance
- Run thermal simulations to understand board thermal performance
- Export customized schematic and layout into popular CAD formats
- Print PDF reports for the design, and share the design with colleagues

Get more information about WEBENCH tools at [www.ti.com/WEBENCH](http://www.ti.com/WEBENCH).

### 9.2.2.2 Setting The Output Voltage

Choose resistors R1 and R2 to set the output voltage within a range of 0.6V to 4V, according to [方程式 3](#). To keep the feedback (FB) net robust from noise, set R2 equal to or lower than 100 kΩ to have at least 0.6 μA of current in the voltage divider. Lower values of FB resistors achieve better noise immunity, and lower light load efficiency, as explained in the [Design Considerations For A Resistive Feedback Divider In A DC/DC Converter Analog Design Journal](#).

$$R1 = R2 \times \left( \frac{V_{OUT}}{V_{FB}} - 1 \right) = R2 \times \left( \frac{V_{OUT}}{0.6V} - 1 \right) \quad (3)$$

For devices with a fixed output voltage, the FB pin must be connected to  $V_{OUT}$ . R1, R2, and C4 are not needed. The fixed output voltage devices have an internal feedforward capacitor.

### 9.2.2.3 Feedforward Capacitor

A feedforward capacitor (C4) is required in parallel with R1. 方程式 4 calculates the capacitor value. For the recommended 100 k value for R2, a 120 pF feedforward capacitor is used. For forced PWM devices, a feedforward capacitor is not needed.

$$C4 = \frac{12 \mu\text{s}}{R2} \quad (4)$$

### 9.2.2.4 Output Filter Design

The inductor and the output capacitor together provide a low-pass filter. To simplify this process, 表 9-4 outlines possible inductor and capacitor value combinations for most applications. Checked cells represent combinations that are proven for stability by simulation and lab test. Further combinations should be checked for each individual application.

表 9-4. Matrix of Output Capacitor and Inductor Combinations

NOMINAL L [ $\mu\text{H}$ ] <sup>(2)</sup>	NOMINAL C <sub>OUT</sub> [ $\mu\text{F}$ ] <sup>(3)</sup>			
	10	2 x 10 or 1 x 22	47	100
0.24	+	+(1)	+	
0.33	+	+	+	
0.47				

- (1) This LC combination is the standard value and recommended for most applications. Other '+' marks indicate recommended filter combinations. Other values may be acceptable in some applications but should be fully tested by the user.
- (2) Inductor tolerance and current derating is anticipated. The effective inductance can vary by 20% and - 30%.
- (3) Capacitance tolerance and bias voltage derating is anticipated. The effective capacitance can vary by 20% and - 50%.

### 9.2.2.5 Inductor Selection

The main parameter for the inductor selection is the inductor value and then the saturation current of the inductor. To calculate the maximum inductor current under static load conditions, 方程式 5 is given.

$$I_{L,MAX} = I_{OUT,MAX} + \frac{\Delta I_L}{2}$$

$$\Delta I_L = V_{OUT} \times \frac{1 - \frac{V_{OUT}}{V_{IN}}}{L \times f_{SW}} \quad (5)$$

where

- $I_{OUT,MAX}$  = Maximum output current
- $\Delta I_L$  = Inductor current ripple
- $f_{SW}$  = Switching frequency
- $L$  = Inductor value

It is recommended to choose a saturation current for the inductor that is approximately 20% to 30% higher than  $I_{L,MAX}$ . In addition, DC resistance and size should also be taken into account when selecting an appropriate inductor. 表 9-5 lists recommended inductors.

表 9-5. List of Recommended Inductors<sup>(1)</sup>

INDUCTANCE [ $\mu\text{H}$ ]	CURRENT RATING [A]	DIMENSIONS [L x W x H mm]	DC RESISTANCE [m $\Omega$ ]	PART NUMBER
0.24	4.9	1.6 x 0.8 x 1.0	30	Murata, DFE160810S-R24M (DFE18SANR24MG0)
0.24	6.5	2.0 x 1.2 x 1.0	25	Murata, DFE201210U-R24M

**表 9-5. List of Recommended Inductors<sup>(1)</sup> (continued)**

INDUCTANCE [ $\mu$ H]	CURRENT RATING [A]	DIMENSIONS [L × W × H mm]	DC RESISTANCE [m $\Omega$ ]	PART NUMBER
0.24	4.9	1.6 × 0.8 × 0.8	22	Cyntec, HTEH16080H-R24MSR
0.25	9.7	4.0 × 4.0 × 1.2	7.64	Coilcraft, XFL4012-251ME
0.24	3.5	2.0 × 1.6 × 0.6	35	Würth Electronics, 74479977124
0.24	3.5	2.0 × 1.6 × 0.6	35	Sunlord, MPM201606SR24M

(1) See [Third-party Products](#) disclaimer.

### 9.2.2.6 Capacitor Selection

The input capacitor is the low-impedance energy source for the converters which helps to provide stable operation. A low-ESR multilayer ceramic capacitor is recommended for best filtering and must be placed between VIN and GND as close as possible to those pins. For most applications, 4.7  $\mu$ F is sufficient, though a larger value reduces input current ripple.

The architecture of the device allows the use of tiny ceramic output capacitors with low equivalent series resistance (ESR). These capacitors provide low output voltage ripple and are recommended. To keep its low resistance up to high frequencies and to get narrow capacitance variation with temperature, TI recommends using X7R or X5R dielectrics. The recommended typical output capacitor value is 2 × 10  $\mu$ F or 1 × 22  $\mu$ F; this capacitance can vary over a wide range as outline in the output filter selection table.

A feedforward capacitor is required for the adjustable version, as described in [节 9.2.2.2](#). This capacitor is not required for the fixed output voltage versions.

### 9.2.3 Application Curves

$V_{IN} = 5.0\text{ V}$ ,  $V_{OUT} = 1.8\text{ V}$ ,  $T_A = 25^\circ\text{C}$ , BOM = 表 9-2, unless otherwise noted.

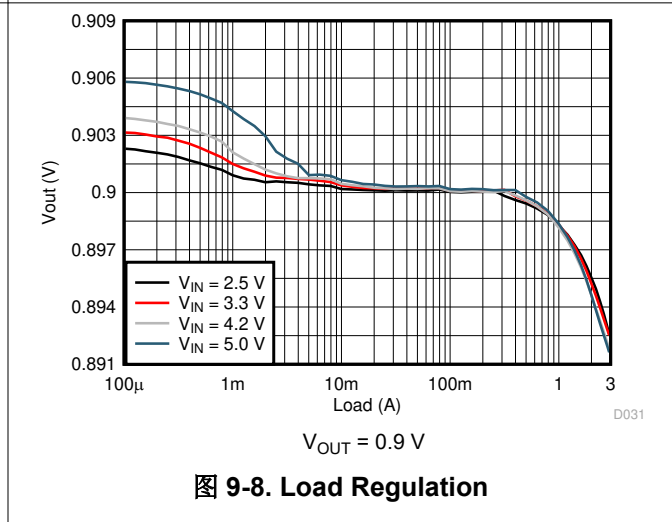
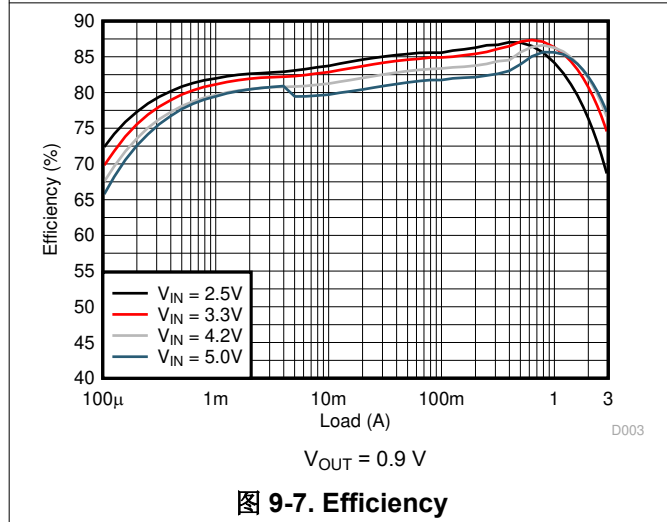
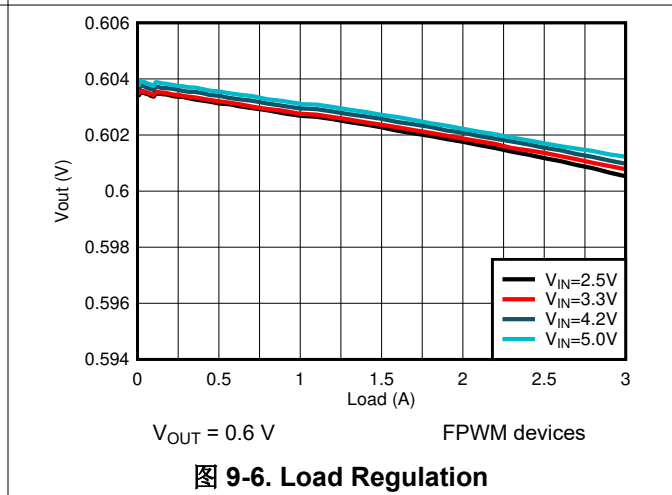
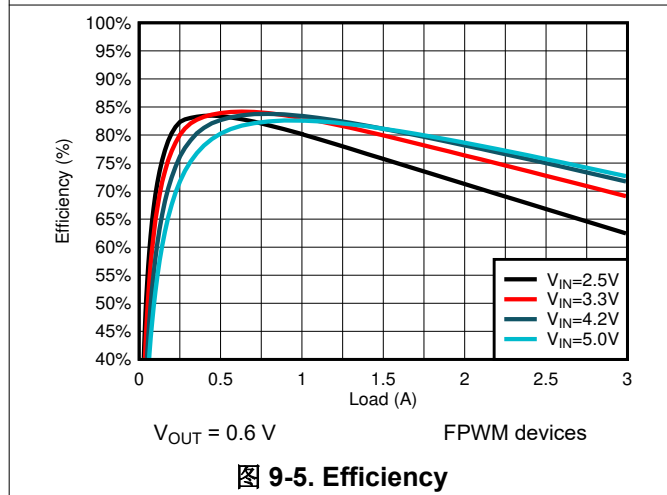
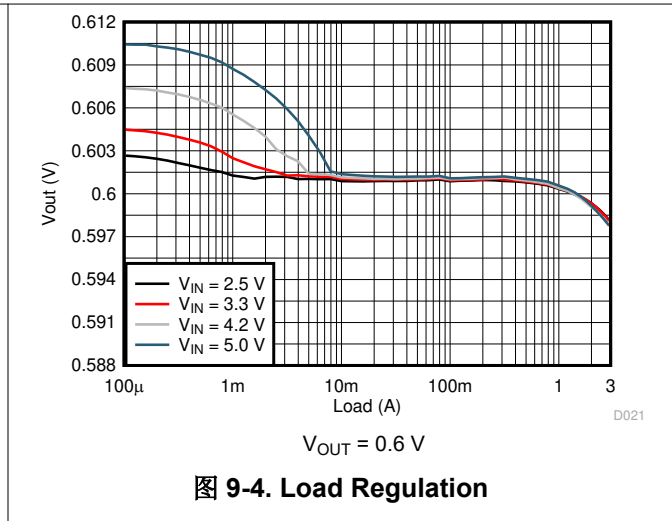
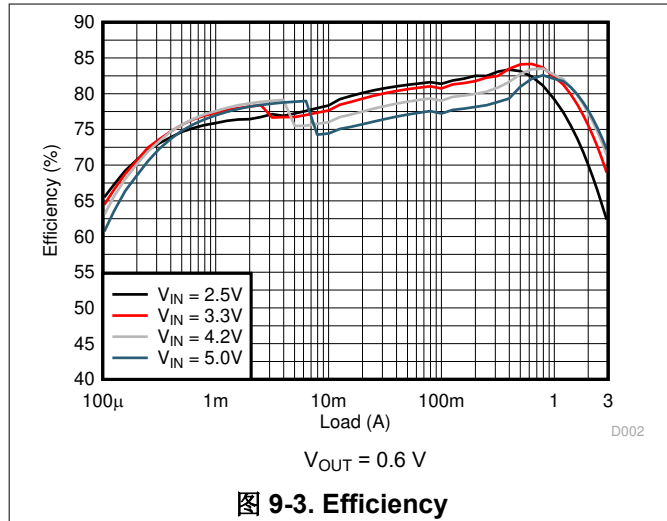



图 9-9. Efficiency



图 9-10. Load Regulation

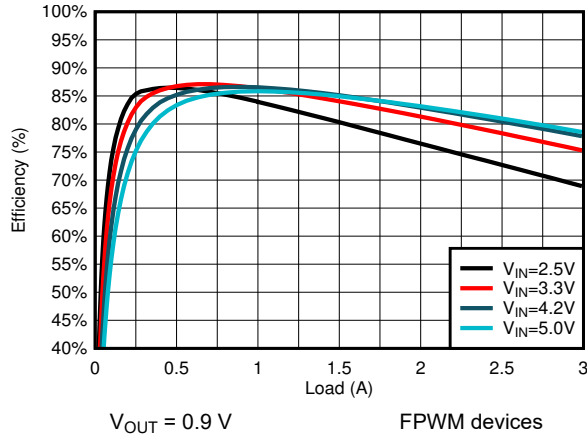

图 9-11. Efficiency

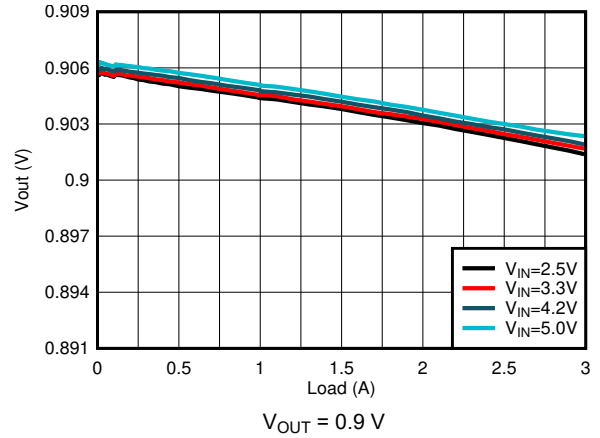

图 9-12. Load Regulation

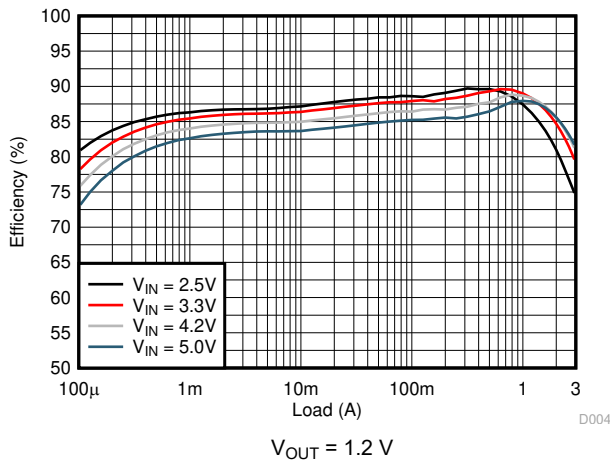

图 9-13. Efficiency

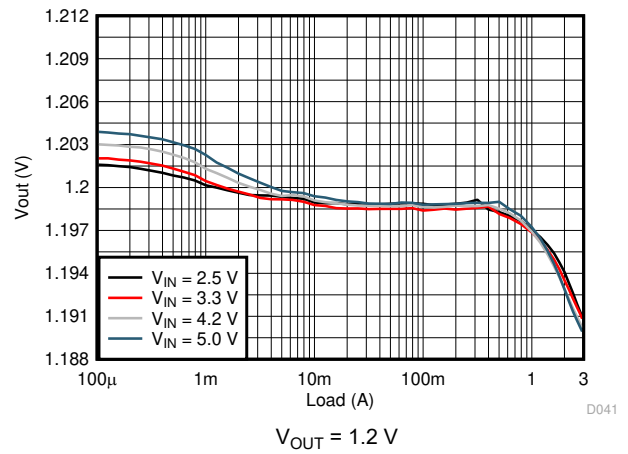

图 9-14. Load Regulation

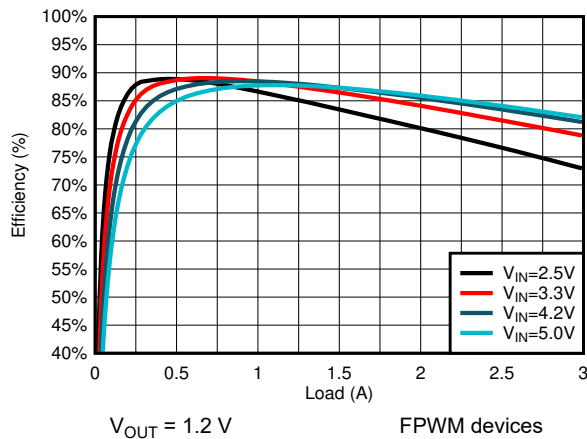

图 9-15. Efficiency

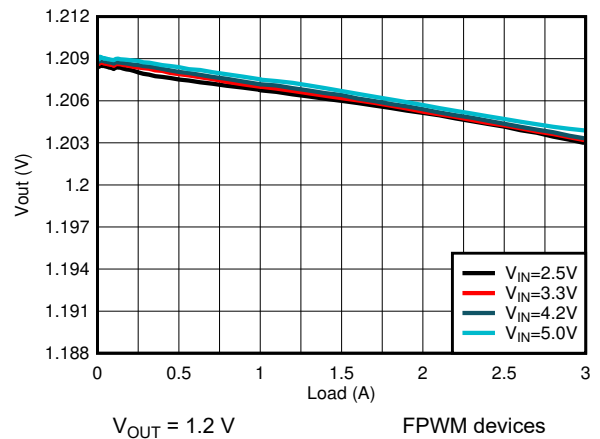

图 9-16. Load Regulation

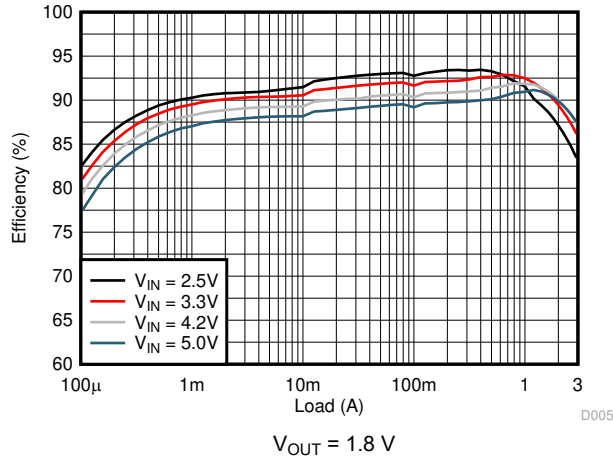

图 9-17. Efficiency

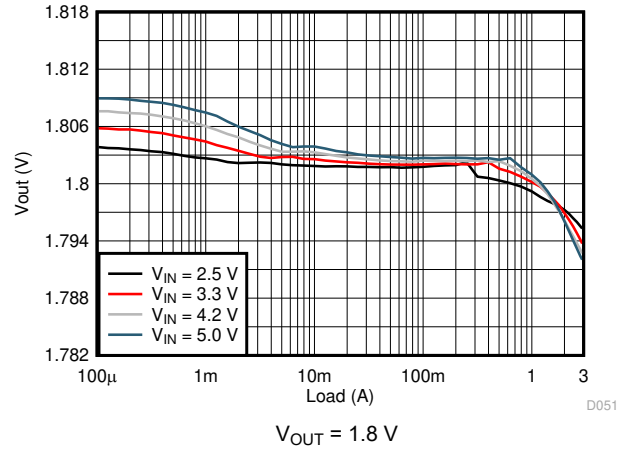

图 9-18. Load Regulation

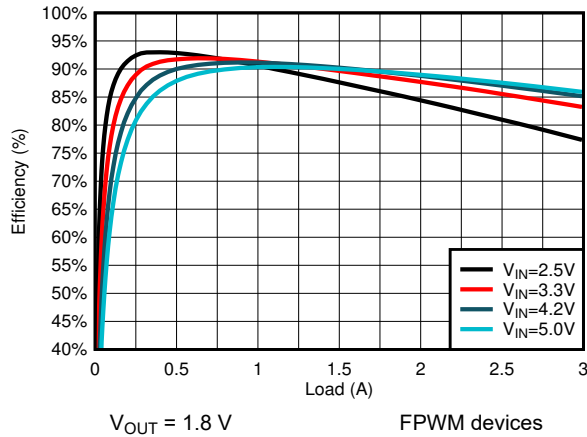

图 9-19. Efficiency

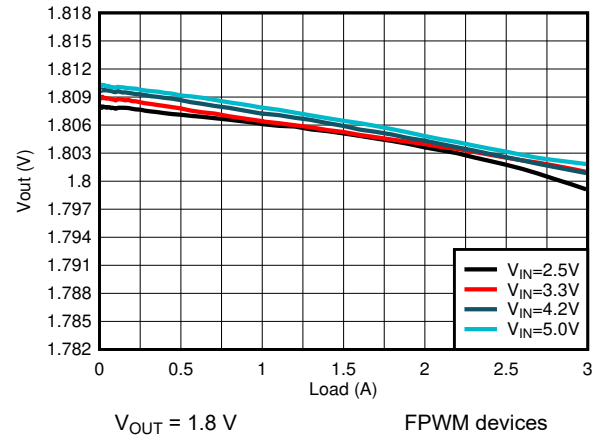

图 9-20. Load Regulation



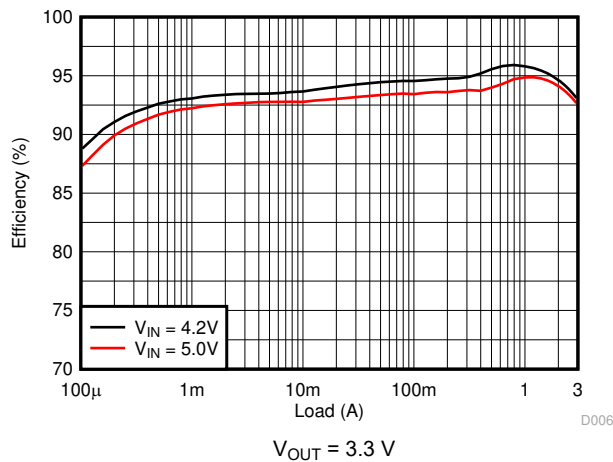

图 9-21. Efficiency

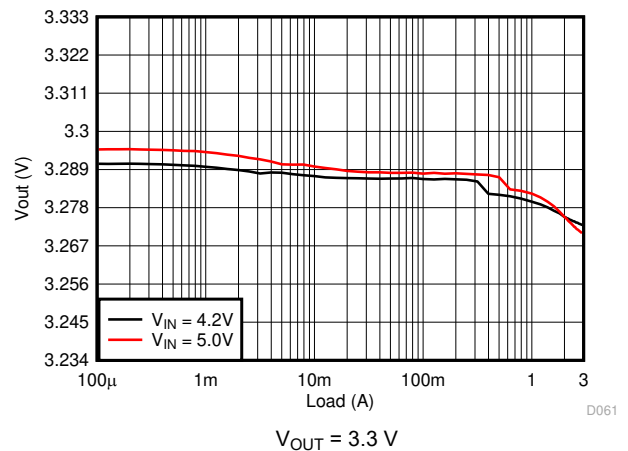

图 9-22. Load Regulation

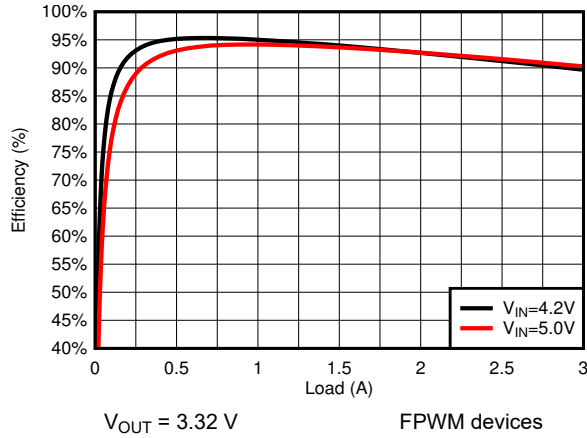

图 9-23. Switching Frequency

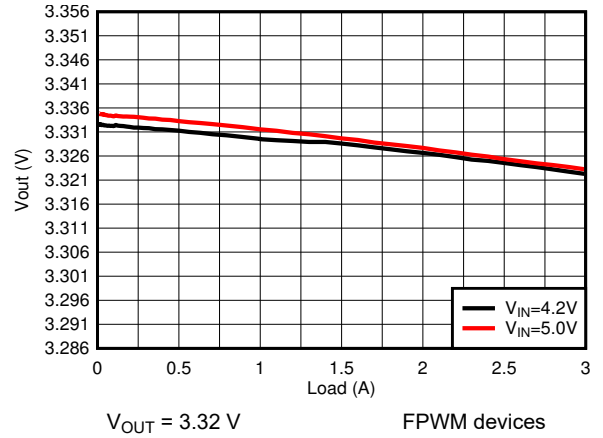

图 9-24. Switching Frequency

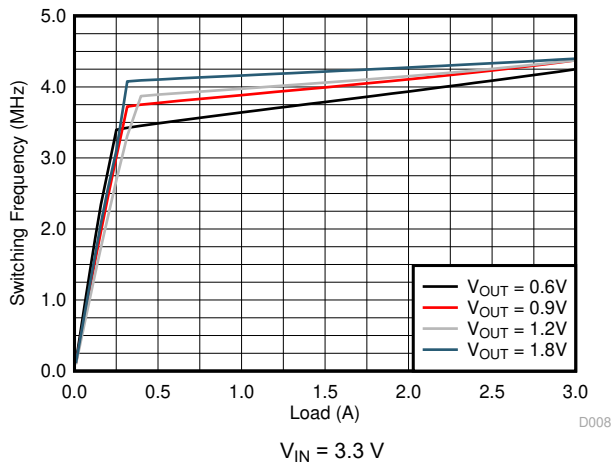

图 9-25. Switching Frequency

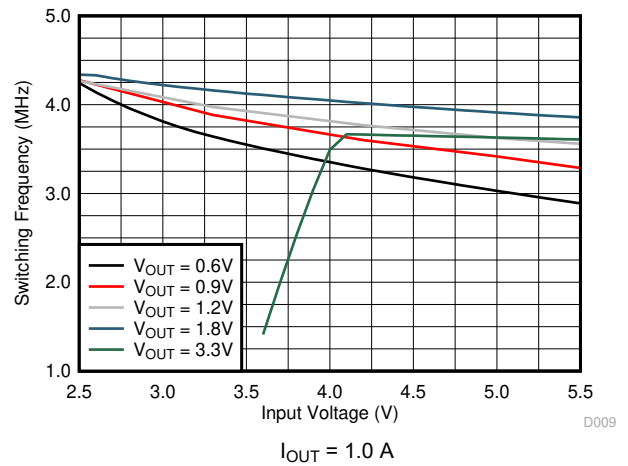

图 9-26. Switching Frequency

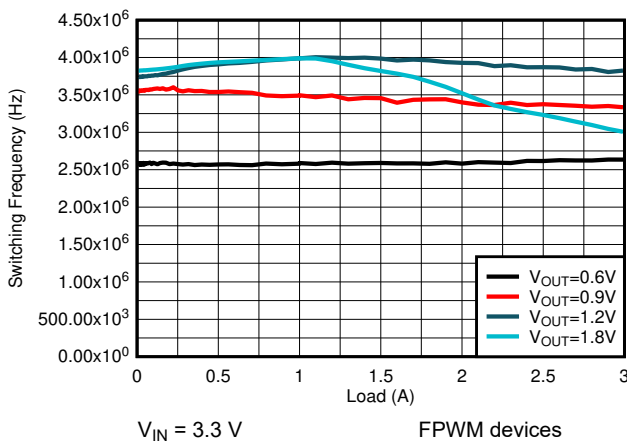

$I_{OUT} = 3.0\text{ A}$

图 9-27. PWM Operation

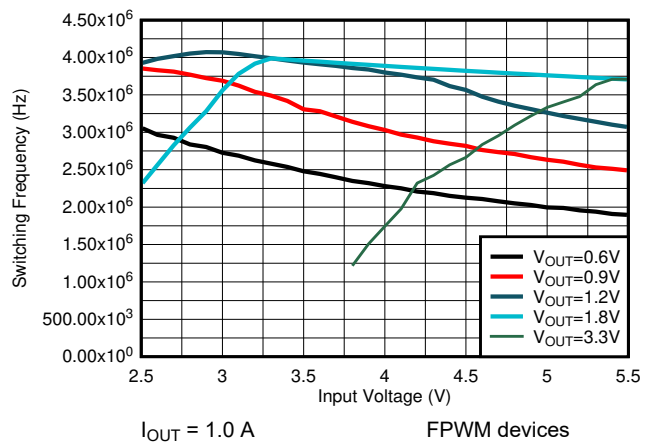
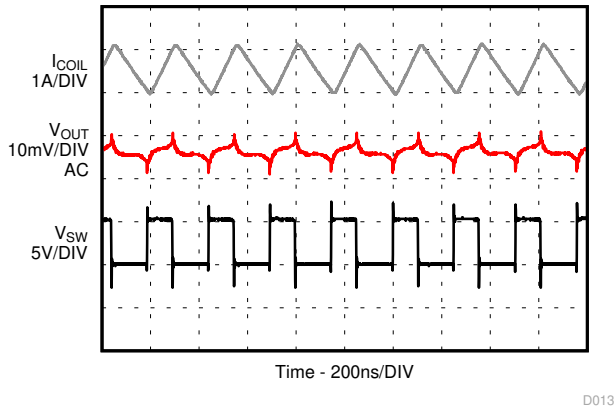
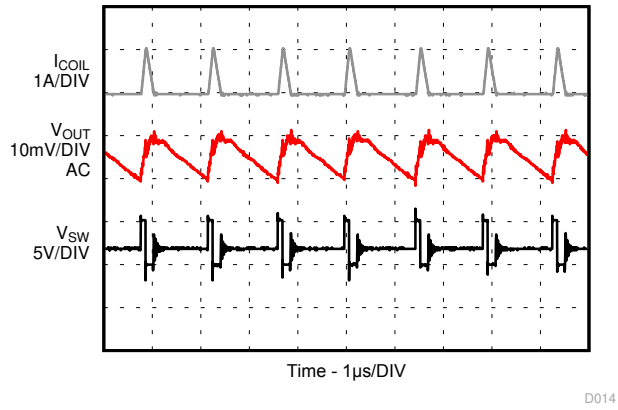

$I_{OUT} = 0.1\text{ A}$

图 9-28. PSM Operation

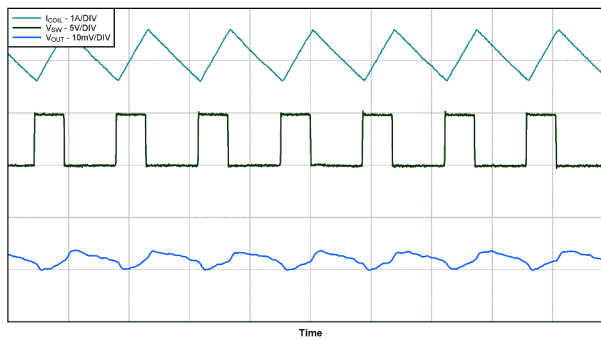

$I_{OUT} = 0.1\text{ A}$

FPWM devices

图 9-29. FPWM Operation

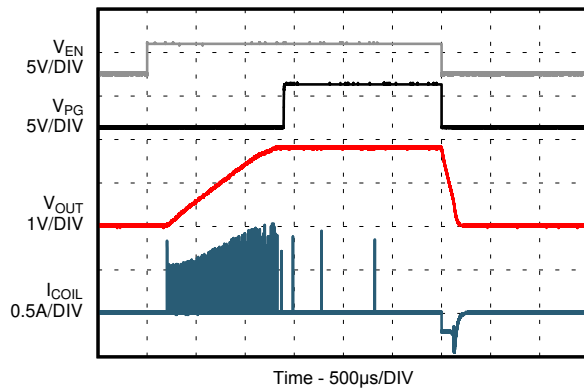

No load

图 9-30. Start-Up with No-Load

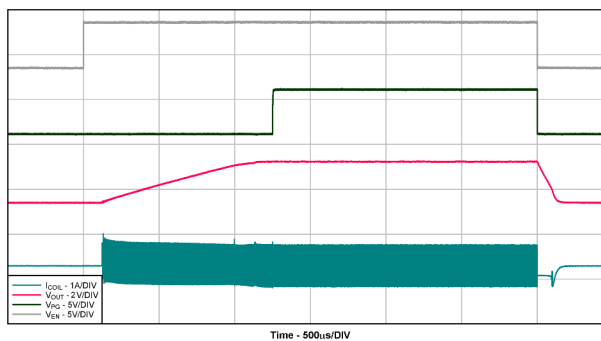

No load

FPWM devices

图 9-31. Start-Up with No-Load

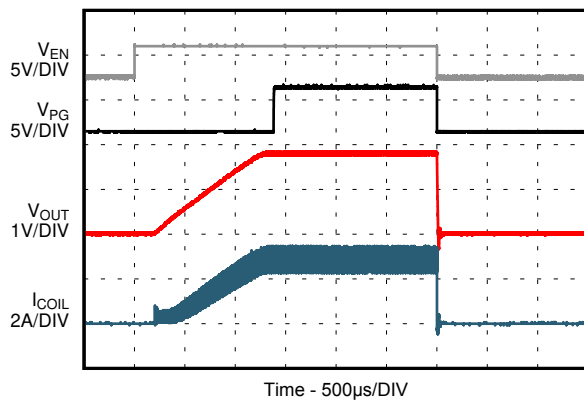

$I_{OUT} = 3.0\text{ A}$

图 9-32. Start-Up with Load

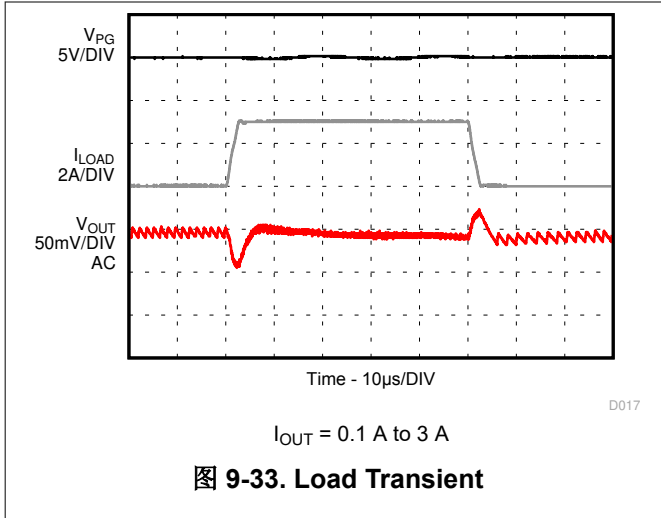

**图 9-33. Load Transient**

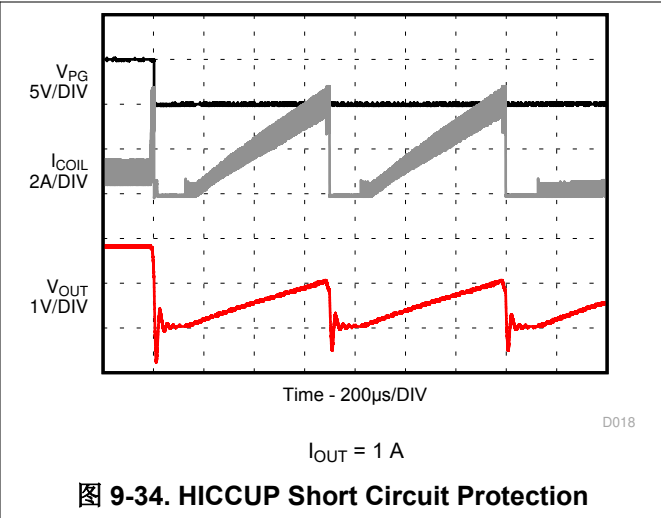

**图 9-34. HICCUP Short Circuit Protection**

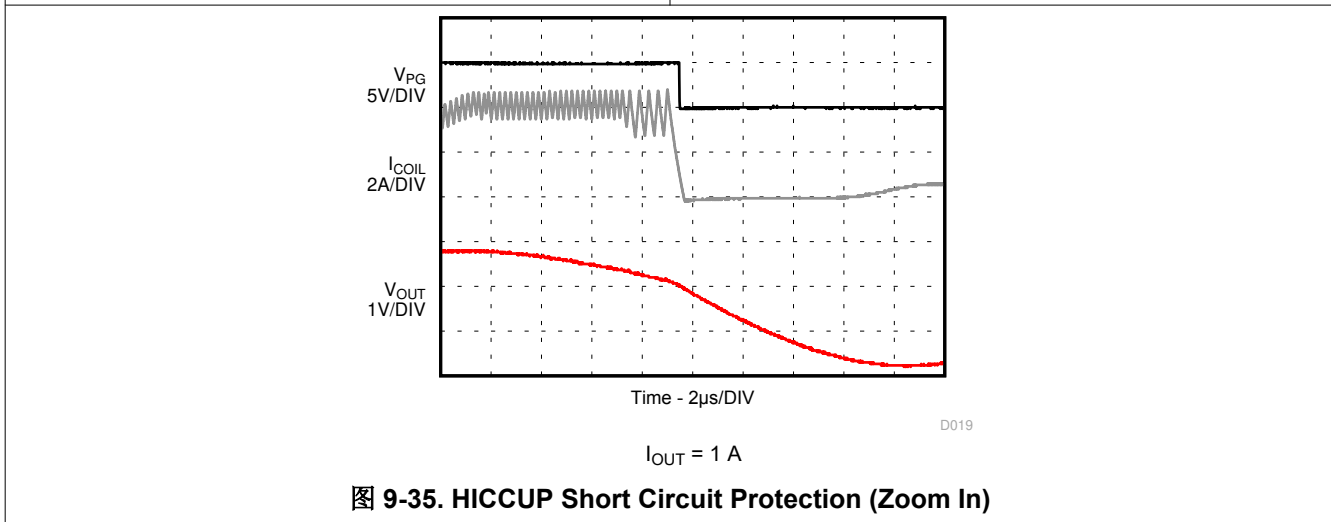

**图 9-35. HICCUP Short Circuit Protection (Zoom In)**

## 10 Power Supply Recommendations

The device is designed to operate from an input voltage supply range from 2.4 V to 5.5 V. Ensure that the input power supply has a sufficient current rating for the application.

## 11 Layout

### 11.1 Layout Guidelines

The printed-circuit-board (PCB) layout is an important step to maintain the high performance of the device. See [图 11-1](#) and [图 11-2](#) for the recommended PCB layout.

- The input/output capacitors and the inductor should be placed as close as possible to the IC. This keeps the power traces short. Routing these power traces direct and wide results in low trace resistance and low parasitic inductance.
- The low side of the input and output capacitors must be connected properly to the power GND to avoid a GND potential shift.
- The sense traces connected to FB is a signal trace. Special care should be taken to avoid noise being induced. Keep these traces away from SW nodes. The connection of the output voltage trace for the FB resistors should be made at the output capacitor.
- Refer to [图 11-1](#) and [图 11-2](#) for an example of component placement, routing and thermal design.

### 11.2 Layout Example

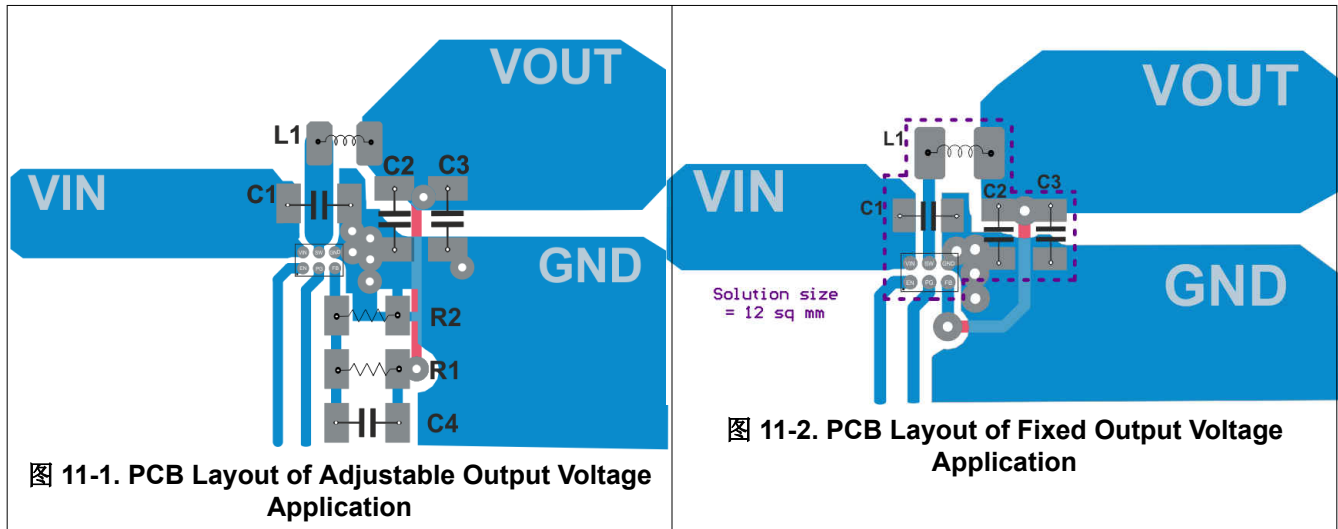

**图 11-1. PCB Layout of Adjustable Output Voltage Application**

**图 11-2. PCB Layout of Fixed Output Voltage Application**

#### 11.2.1 Thermal Considerations

Implementation of integrated circuits in low-profile and fine-pitch surface-mount packages typically requires special attention to power dissipation. Many system-dependent issues such as thermal coupling, airflow, added heat sinks and convection surfaces, and the presence of other heat-generating components affect the power dissipation limits of a given component.

Two basic approaches for enhancing thermal performance are:

- Improving the power dissipation capability of the PCB design
- Introducing airflow in the system

For more details on how to use the thermal parameters, see the [Thermal Characteristics Application Notes](#), [Thermal Characteristics of Linear and Logic Packages Using JEDEC PCB Designs Application Report](#) and [Semiconductor and IC Package Thermal Metrics Application Report](#).

## 12 Device and Documentation Support

### 12.1 Device Support

#### 12.1.1 第三方产品免责声明

TI 发布的与第三方产品或服务有关的信息，不能构成与此类产品或服务或保修的适用性有关的认可，不能构成此类产品或服务单独或与任何 TI 产品或服务一起的表示或认可。

#### 12.1.2 Development Support

##### 12.1.2.1 Custom Design With WEBENCH® Tools

[Click here](#) to create a custom design using the TPS62088 device with the WEBENCH® Power Designer.

1. Start by entering the input voltage ( $V_{IN}$ ), output voltage ( $V_{OUT}$ ), and output current ( $I_{OUT}$ ) requirements.
2. Optimize the design for key parameters such as efficiency, footprint, and cost using the optimizer dial.
3. Compare the generated design with other possible solutions from Texas Instruments.

The WEBENCH Power Designer provides a customized schematic along with a list of materials with real-time pricing and component availability.

In most cases, these actions are available:

- Run electrical simulations to see important waveforms and circuit performance
- Run thermal simulations to understand board thermal performance
- Export customized schematic and layout into popular CAD formats
- Print PDF reports for the design, and share the design with colleagues

Get more information about WEBENCH tools at [www.ti.com/WEBENCH](http://www.ti.com/WEBENCH).

### 12.2 Documentation Support

#### 12.2.1 Related Documentation

For related documentation, see the following:

- Texas Instruments, [Thermal Characteristics of Linear and Logic Packages Using JEDEC PCB Designs Application Report](#)
- Texas Instruments, [Semiconductor and IC Package Thermal Metrics Application Report](#)

### 12.3 接收文档更新通知

要接收文档更新通知，请导航至 [ti.com](http://ti.com) 上的器件产品文件夹。点击 [订阅更新](#) 进行注册，即可每周接收产品信息更改摘要。有关更改的详细信息，请查看任何已修订文档中包含的修订历史记录。

### 12.4 支持资源

[TI E2E™ 支持论坛](#) 是工程师的重要参考资料，可直接从专家获得快速、经过验证的解答和设计帮助。搜索现有解答或提出自己的问题可获得所需的快速设计帮助。

链接的内容由各个贡献者“按原样”提供。这些内容并不构成 TI 技术规范，并且不一定反映 TI 的观点；请参阅 TI 的《[使用条款](#)》。

### 12.5 Trademarks

TI E2E™ is a trademark of Texas Instruments.

所有商标均为其各自所有者的财产。

### 12.6 Electrostatic Discharge Caution



This integrated circuit can be damaged by ESD. Texas Instruments recommends that all integrated circuits be handled with appropriate precautions. Failure to observe proper handling and installation procedures can cause damage.

ESD damage can range from subtle performance degradation to complete device failure. Precision integrated circuits may be more susceptible to damage because very small parametric changes could cause the device not to meet its published specifications.

## 12.7 术语表

[TI 术语表](#) 本术语表列出并解释了术语、首字母缩略词和定义。

## 13 Mechanical, Packaging, and Orderable Information

The following pages include mechanical, packaging, and orderable information. This information is the most current data available for the designated devices. This data is subject to change without notice and revision of this document. For browser-based versions of this data sheet, refer to the left-hand navigation.

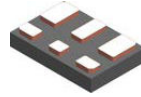

**PACKAGE OUTLINE**

**YWC0006A**

**PowerWCSPP - 0.3 mm max height**

POWER CHIP SCALE PACKAGE

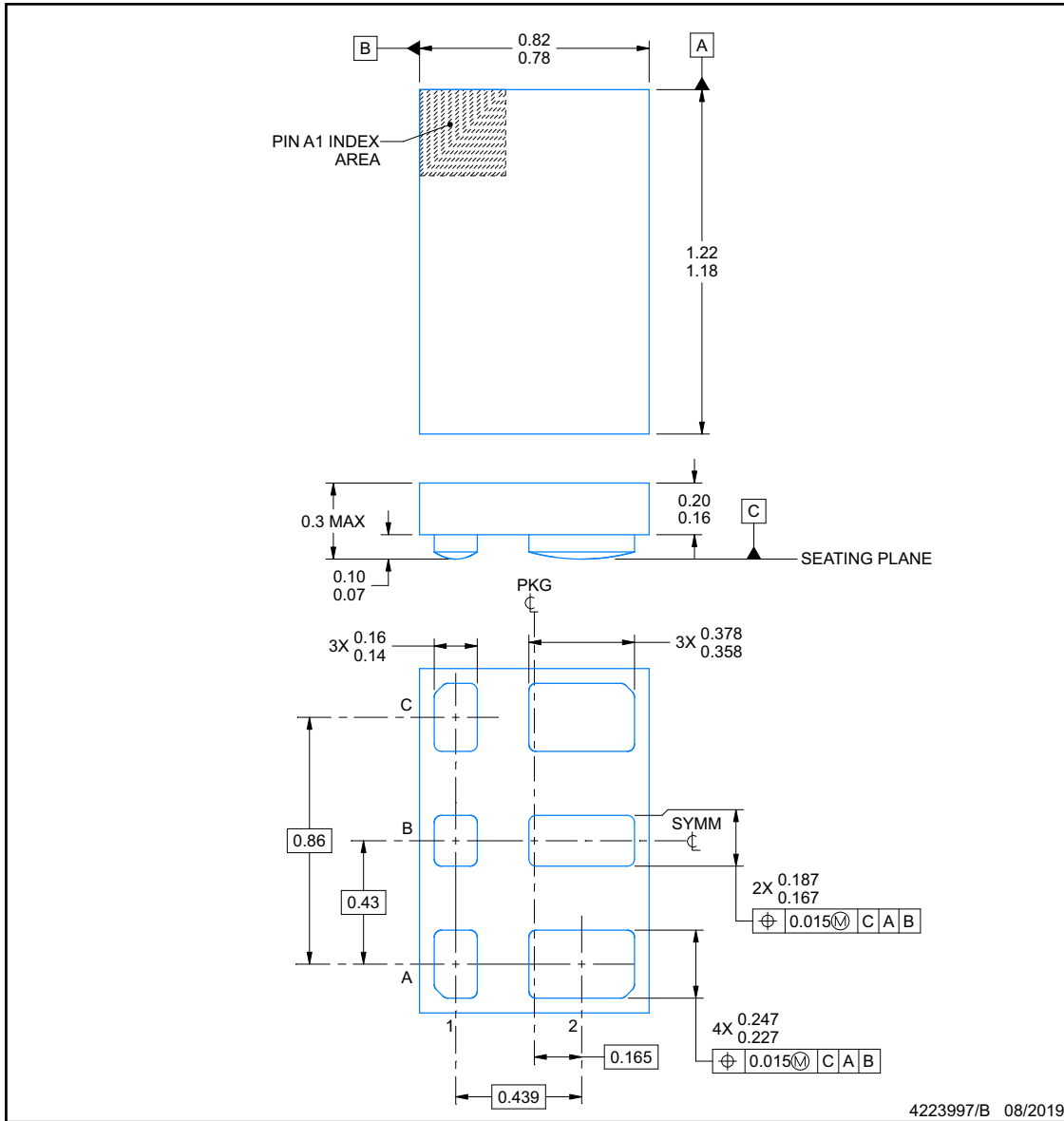

**NOTES:**

1. All linear dimensions are in millimeters. Any dimensions in parenthesis are for reference only. Dimensioning and tolerancing per ASME Y14.5M.
2. This drawing is subject to change without notice.

## EXAMPLE BOARD LAYOUT

### YWC0006A

### PowerWCSP - 0.3 mm max height

POWER CHIP SCALE PACKAGE

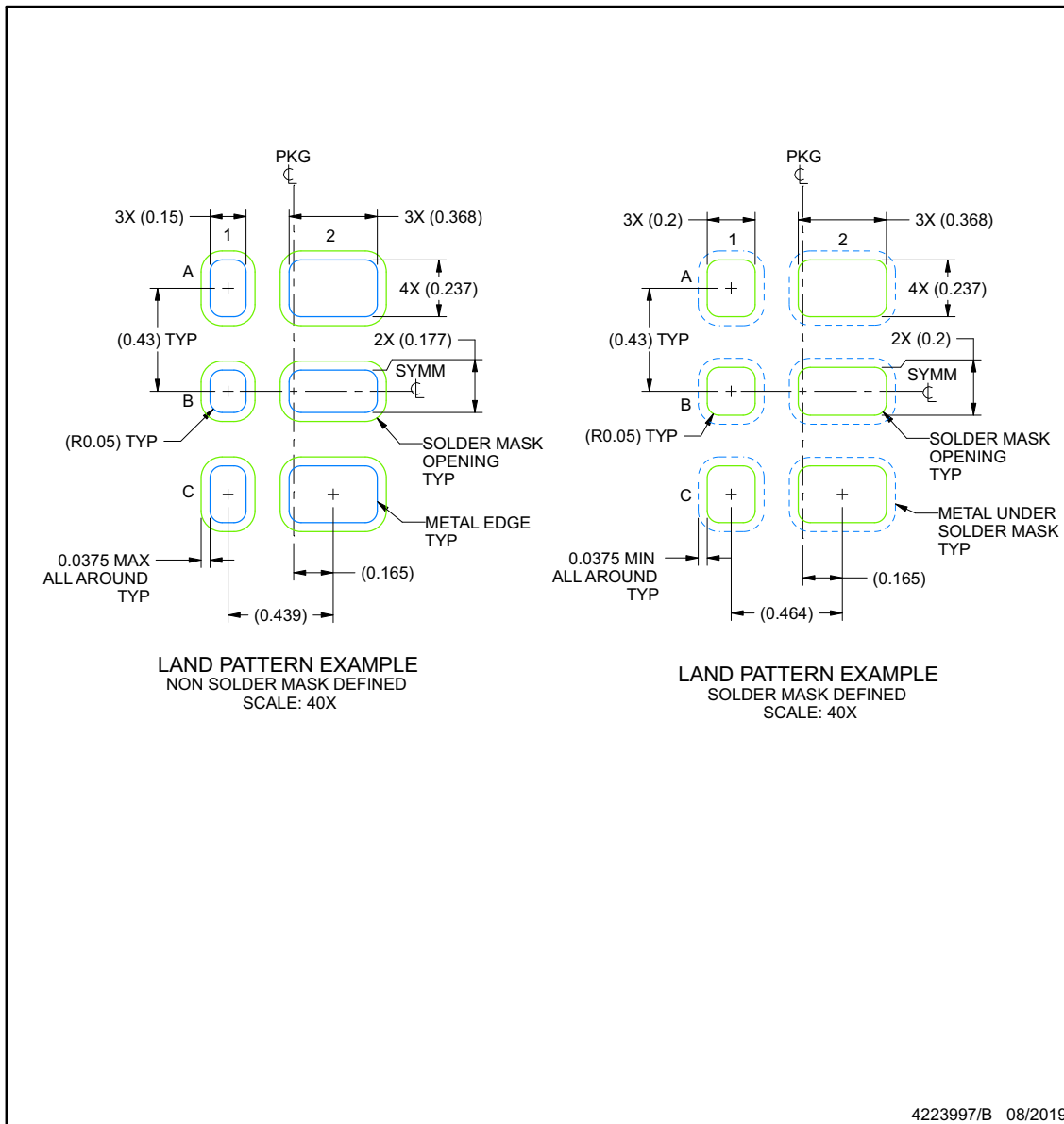

NOTES: (continued)

- Final dimensions may vary due to manufacturing tolerance considerations and also routing constraints. For more information, see Texas Instruments literature number SLUA271 ([www.ti.com/lit/slua271](http://www.ti.com/lit/slua271)).



## EXAMPLE STENCIL DESIGN

**YWC0006A**

**PowerWCSP - 0.3 mm max height**

POWER CHIP SCALE PACKAGE

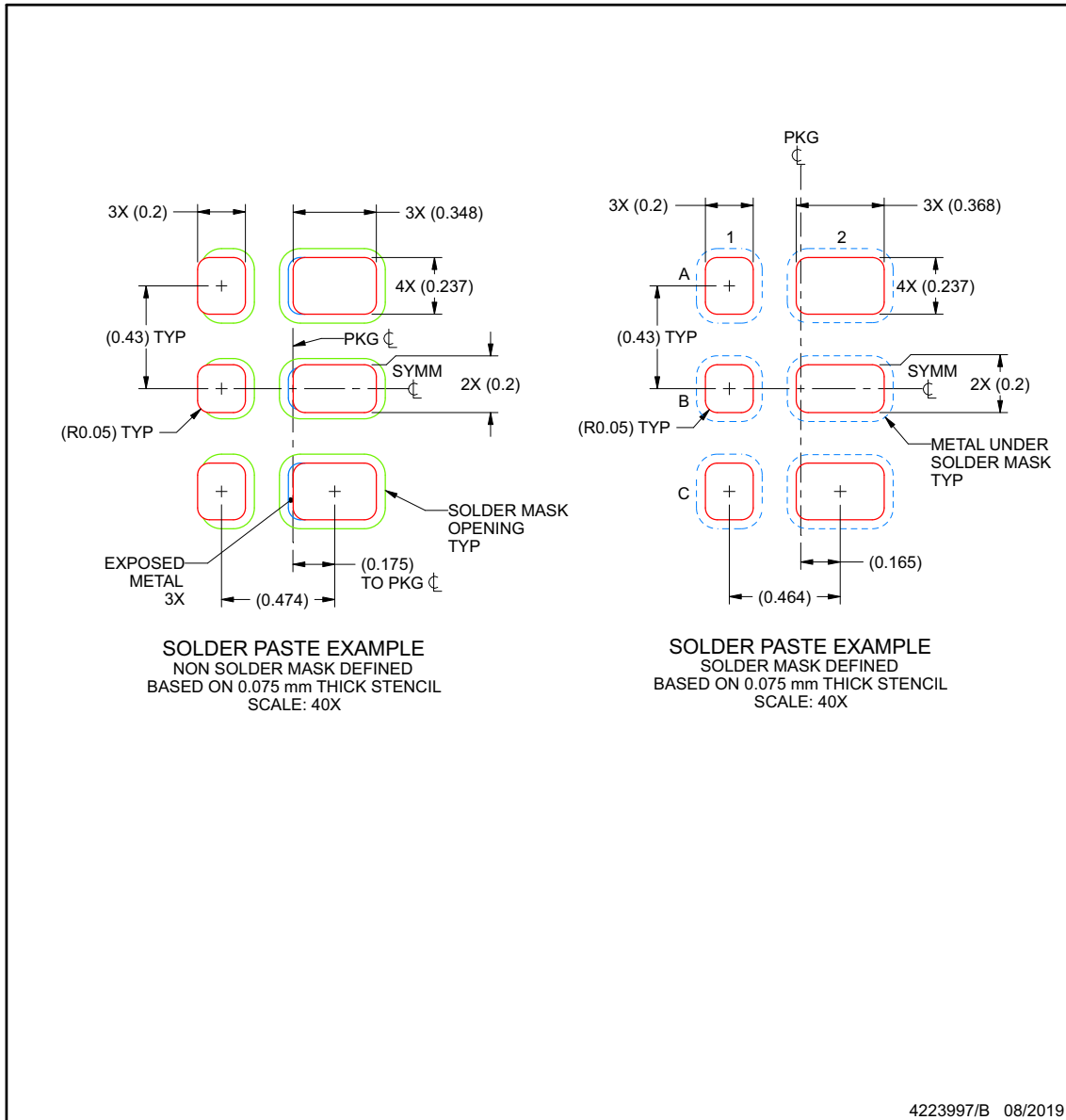

NOTES: (continued)

4. Laser cutting apertures with trapezoidal walls and rounded corners may offer better paste release.



**YFP0006-C01**

**PACKAGE OUTLINE**

**DSBGA - 0.5 mm max height**

DIE SIZE BALL GRID ARRAY

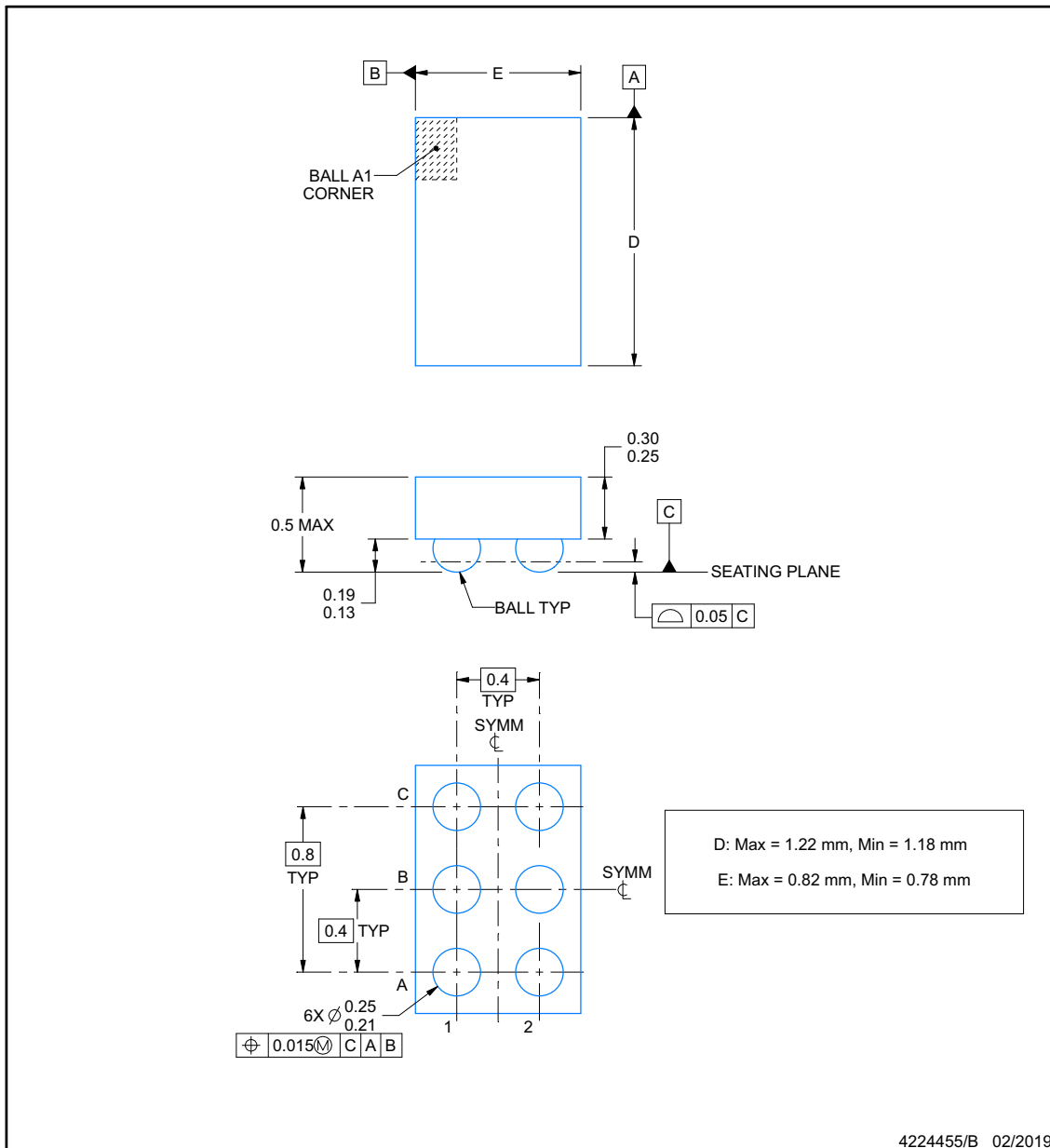

NOTES:

1. All linear dimensions are in millimeters. Any dimensions in parenthesis are for reference only. Dimensioning and tolerancing per ASME Y14.5M.
2. This drawing is subject to change without notice.

## EXAMPLE BOARD LAYOUT

**YFP0006-C01**

**DSBGA - 0.5 mm max height**

DIE SIZE BALL GRID ARRAY

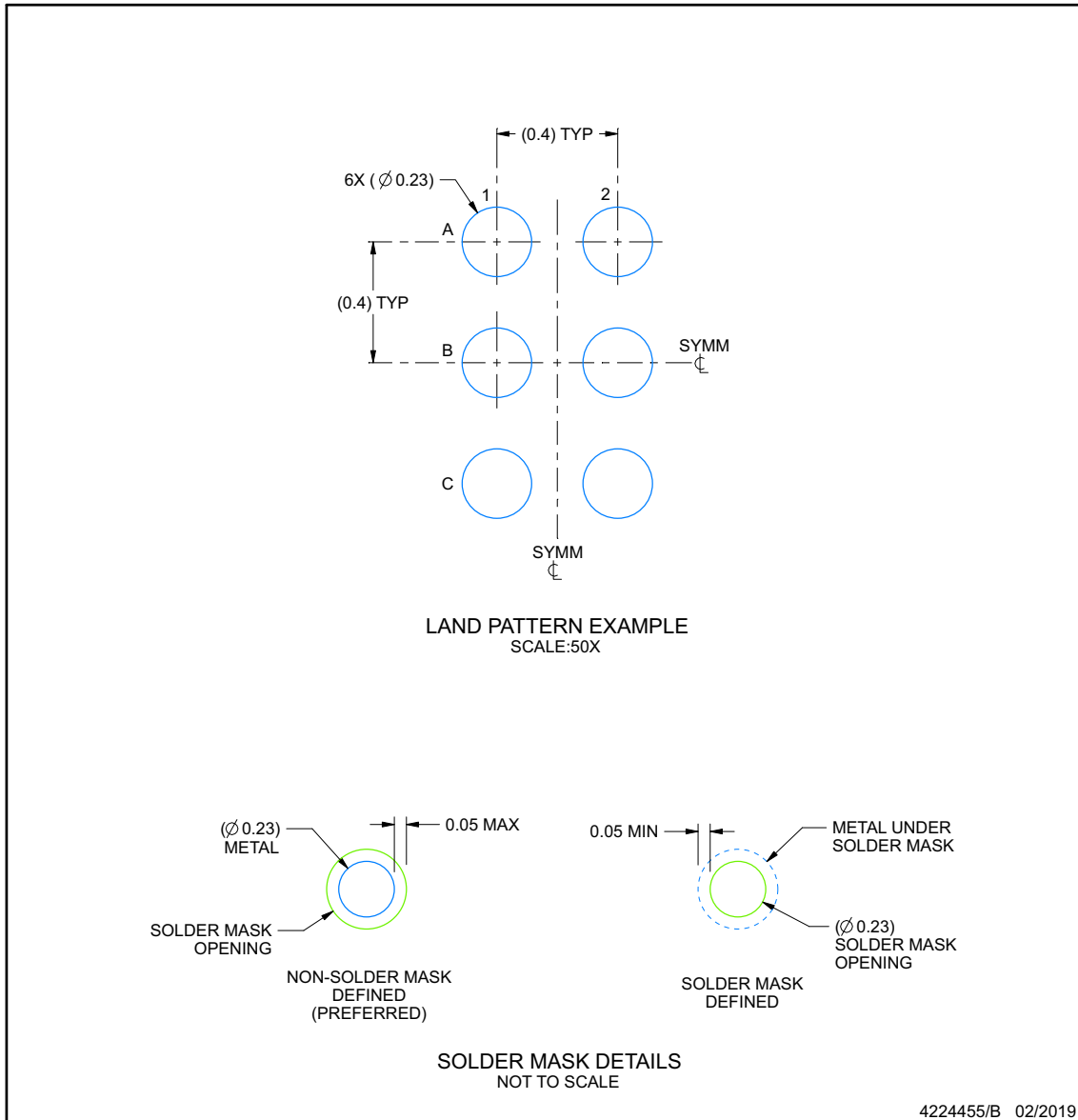

4224455/B 02/2019

NOTES: (continued)

- Final dimensions may vary due to manufacturing tolerance considerations and also routing constraints. For more information, see Texas Instruments literature number SNVA009 ([www.ti.com/lit/snva009](http://www.ti.com/lit/snva009)).

## EXAMPLE STENCIL DESIGN

**YFP0006-C01**

**DSBGA - 0.5 mm max height**

DIE SIZE BALL GRID ARRAY

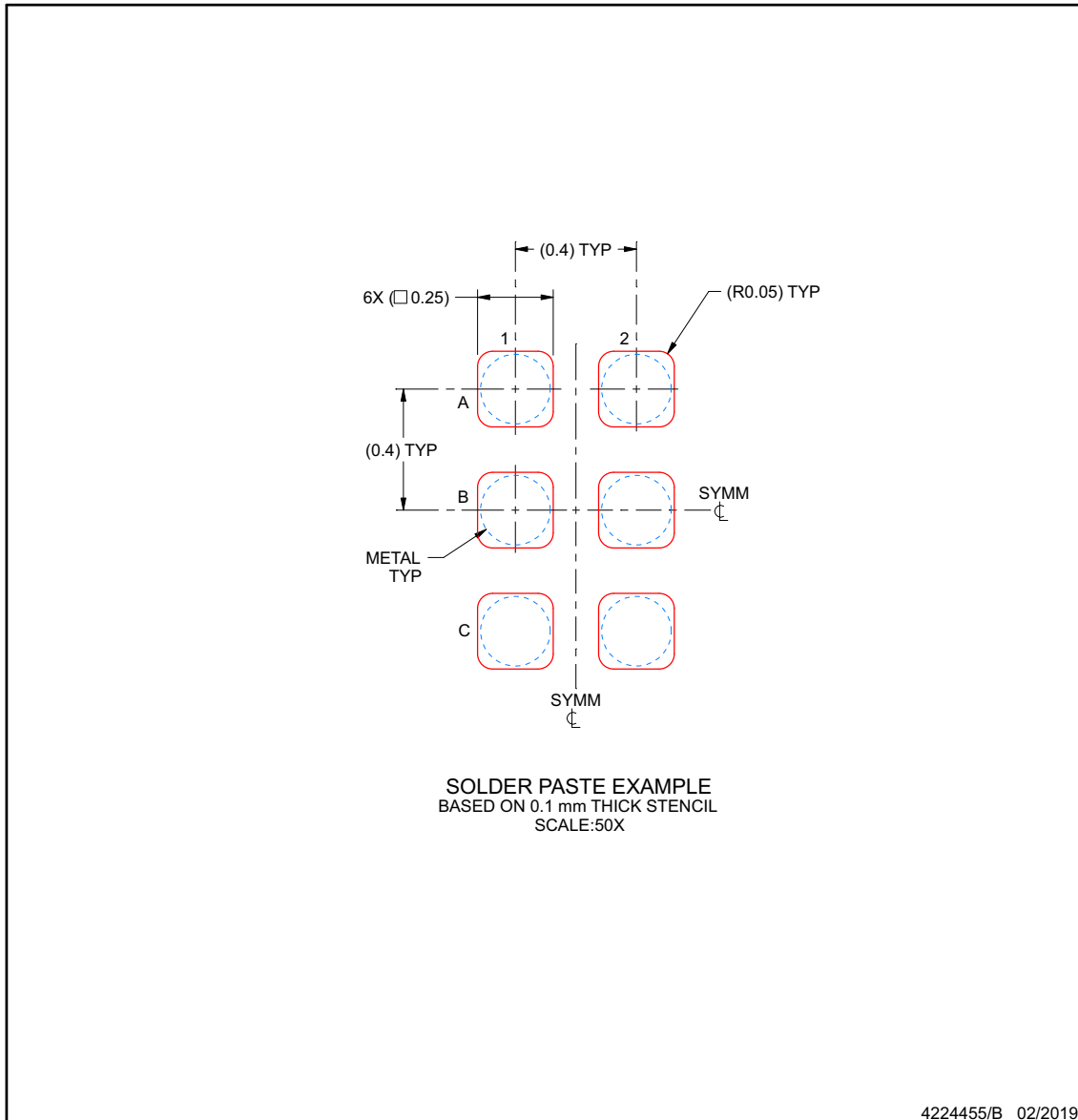

NOTES: (continued)

4. Laser cutting apertures with trapezoidal walls and rounded corners may offer better paste release.

**PACKAGING INFORMATION**

Orderable Device	Status (1)	Package Type	Package Drawing	Pins	Package Qty	Eco Plan (2)	Lead finish/ Ball material (6)	MSL Peak Temp (3)	Op Temp (°C)	Device Marking (4/5)	Samples
TPS6208812YFPR	ACTIVE	DSBGA	YFP	6	3000	RoHS & Green	SNAGCU	Level-1-260C-UNLIM	-40 to 125	1B5	<a href="#">Samples</a>
TPS6208812YFPT	ACTIVE	DSBGA	YFP	6	250	RoHS & Green	SNAGCU	Level-1-260C-UNLIM	-40 to 125	1B5	<a href="#">Samples</a>
TPS6208818YFPR	ACTIVE	DSBGA	YFP	6	3000	RoHS & Green	SNAGCU	Level-1-260C-UNLIM	-40 to 125	1B6	<a href="#">Samples</a>
TPS6208818YFPT	ACTIVE	DSBGA	YFP	6	250	RoHS & Green	SNAGCU	Level-1-260C-UNLIM	-40 to 125	1B6	<a href="#">Samples</a>
TPS6208833YFPR	ACTIVE	DSBGA	YFP	6	3000	RoHS & Green	SNAGCU	Level-1-260C-UNLIM	-40 to 125	1B7	<a href="#">Samples</a>
TPS6208833YFPT	ACTIVE	DSBGA	YFP	6	250	RoHS & Green	SNAGCU	Level-1-260C-UNLIM	-40 to 125	1B7	<a href="#">Samples</a>
TPS62088AYFPJ	ACTIVE	DSBGA	YFP	6	6000	RoHS & Green	SNAGCU	Level-1-260C-UNLIM	-40 to 125	W	<a href="#">Samples</a>
TPS62088AYFPR	ACTIVE	DSBGA	YFP	6	3000	RoHS & Green	SNAGCU	Level-1-260C-UNLIM	-40 to 125	W	<a href="#">Samples</a>
TPS62088YFPR	ACTIVE	DSBGA	YFP	6	3000	RoHS & Green	SNAGCU	Level-1-260C-UNLIM	-40 to 125	15X	<a href="#">Samples</a>
TPS62088YFPT	ACTIVE	DSBGA	YFP	6	250	RoHS & Green	SNAGCU	Level-1-260C-UNLIM	-40 to 125	15X	<a href="#">Samples</a>
TPS62088YWCR	ACTIVE	DSBGA	YWC	6	3000	RoHS & Green	Call TI	Level-1-260C-UNLIM	-40 to 125	1GB	<a href="#">Samples</a>
TPS62089AYFPR	ACTIVE	DSBGA	YFP	6	3000	RoHS & Green	SNAGCU	Level-1-260C-UNLIM	-40 to 125	X	<a href="#">Samples</a>

(1) The marketing status values are defined as follows:

**ACTIVE:** Product device recommended for new designs.

**LIFEBUY:** TI has announced that the device will be discontinued, and a lifetime-buy period is in effect.

**NRND:** Not recommended for new designs. Device is in production to support existing customers, but TI does not recommend using this part in a new design.

**PREVIEW:** Device has been announced but is not in production. Samples may or may not be available.

**OBSOLETE:** TI has discontinued the production of the device.

(2) **RoHS:** TI defines "RoHS" to mean semiconductor products that are compliant with the current EU RoHS requirements for all 10 RoHS substances, including the requirement that RoHS substance do not exceed 0.1% by weight in homogeneous materials. Where designed to be soldered at high temperatures, "RoHS" products are suitable for use in specified lead-free processes. TI may reference these types of products as "Pb-Free".

**RoHS Exempt:** TI defines "RoHS Exempt" to mean products that contain lead but are compliant with EU RoHS pursuant to a specific EU RoHS exemption.

**Green:** TI defines "Green" to mean the content of Chlorine (Cl) and Bromine (Br) based flame retardants meet JS709B low halogen requirements of <=1000ppm threshold. Antimony trioxide based flame retardants must also meet the <=1000ppm threshold requirement.

- (3) MSL, Peak Temp. - The Moisture Sensitivity Level rating according to the JEDEC industry standard classifications, and peak solder temperature.
- (4) There may be additional marking, which relates to the logo, the lot trace code information, or the environmental category on the device.
- (5) Multiple Device Markings will be inside parentheses. Only one Device Marking contained in parentheses and separated by a "~" will appear on a device. If a line is indented then it is a continuation of the previous line and the two combined represent the entire Device Marking for that device.
- (6) Lead finish/Ball material - Orderable Devices may have multiple material finish options. Finish options are separated by a vertical ruled line. Lead finish/Ball material values may wrap to two lines if the finish value exceeds the maximum column width.

**Important Information and Disclaimer:**The information provided on this page represents TI's knowledge and belief as of the date that it is provided. TI bases its knowledge and belief on information provided by third parties, and makes no representation or warranty as to the accuracy of such information. Efforts are underway to better integrate information from third parties. TI has taken and continues to take reasonable steps to provide representative and accurate information but may not have conducted destructive testing or chemical analysis on incoming materials and chemicals. TI and TI suppliers consider certain information to be proprietary, and thus CAS numbers and other limited information may not be available for release.

In no event shall TI's liability arising out of such information exceed the total purchase price of the TI part(s) at issue in this document sold by TI to Customer on an annual basis.

**TAPE AND REEL INFORMATION**

**QUADRANT ASSIGNMENTS FOR PIN 1 ORIENTATION IN TAPE**

\*All dimensions are nominal

Device	Package Type	Package Drawing	Pins	SPQ	Reel Diameter (mm)	Reel Width W1 (mm)	A0 (mm)	B0 (mm)	K0 (mm)	P1 (mm)	W (mm)	Pin1 Quadrant
TPS6208812YFPR	DSBGA	YFP	6	3000	180.0	8.4	0.9	1.3	0.62	4.0	8.0	Q1
TPS6208812YFPT	DSBGA	YFP	6	250	180.0	8.4	0.9	1.3	0.62	4.0	8.0	Q1
TPS6208833YFPR	DSBGA	YFP	6	3000	180.0	8.4	0.9	1.3	0.62	4.0	8.0	Q1
TPS6208833YFPT	DSBGA	YFP	6	250	180.0	8.4	0.9	1.3	0.62	4.0	8.0	Q1
TPS62088AYFPJ	DSBGA	YFP	6	6000	180.0	8.4	0.89	1.31	0.57	2.0	8.0	Q1
TPS62088AYFPR	DSBGA	YFP	6	3000	180.0	8.4	0.89	1.31	0.57	2.0	8.0	Q1
TPS62088YFPR	DSBGA	YFP	6	3000	180.0	8.4	0.9	1.3	0.62	4.0	8.0	Q1
TPS62088YFPT	DSBGA	YFP	6	250	180.0	8.4	0.9	1.3	0.62	4.0	8.0	Q1
TPS62088YWCR	DSBGA	YWC	6	3000	180.0	8.4	0.95	1.35	0.38	4.0	8.0	Q1
TPS62089AYFPR	DSBGA	YFP	6	3000	180.0	8.4	0.89	1.31	0.57	2.0	8.0	Q1

**TAPE AND REEL BOX DIMENSIONS**

\*All dimensions are nominal

Device	Package Type	Package Drawing	Pins	SPQ	Length (mm)	Width (mm)	Height (mm)
TPS6208812YFPR	DSBGA	YFP	6	3000	182.0	182.0	20.0
TPS6208812YFPT	DSBGA	YFP	6	250	210.0	185.0	35.0
TPS6208833YFPR	DSBGA	YFP	6	3000	182.0	182.0	20.0
TPS6208833YFPT	DSBGA	YFP	6	250	182.0	182.0	20.0
TPS62088AYFPJ	DSBGA	YFP	6	6000	182.0	182.0	20.0
TPS62088AYFPR	DSBGA	YFP	6	3000	182.0	182.0	20.0
TPS62088YFPR	DSBGA	YFP	6	3000	182.0	182.0	20.0
TPS62088YFPT	DSBGA	YFP	6	250	182.0	182.0	20.0
TPS62088YWCR	DSBGA	YWC	6	3000	182.0	182.0	20.0
TPS62089AYFPR	DSBGA	YFP	6	3000	182.0	182.0	20.0



## 重要声明和免责声明

TI“按原样”提供技术和可靠性数据（包括数据表）、设计资源（包括参考设计）、应用或其他设计建议、网络工具、安全信息和其他资源，不保证没有瑕疵且不做任何明示或暗示的担保，包括但不限于对适销性、某特定用途方面的适用性或不侵犯任何第三方知识产权的暗示担保。

这些资源可供使用 TI 产品进行设计的熟练开发人员使用。您将自行承担以下全部责任：(1) 针对您的应用选择合适的 TI 产品，(2) 设计、验证并测试您的应用，(3) 确保您的应用满足相应标准以及任何其他功能安全、信息安全、监管或其他要求。

这些资源如有变更，恕不另行通知。TI 授权您仅可将这些资源用于研发本资源所述的 TI 产品的应用。严禁对这些资源进行其他复制或展示。您无权使用任何其他 TI 知识产权或任何第三方知识产权。您应全额赔偿因在这些资源的使用中对 TI 及其代表造成的任何索赔、损害、成本、损失和债务，TI 对此概不负责。

TI 提供的产品受 [TI 的销售条款](#) 或 [ti.com](#) 上其他适用条款/TI 产品随附的其他适用条款的约束。TI 提供这些资源并不会扩展或以其他方式更改 TI 针对 TI 产品发布的适用的担保或担保免责声明。

TI 反对并拒绝您可能提出的任何其他或不同的条款。

邮寄地址：Texas Instruments, Post Office Box 655303, Dallas, Texas 75265

Copyright © 2023，德州仪器 (TI) 公司