

4.5V 至 18V 输入电压 1.5A, 2.5A, 1.5A 三路同步降压转换器

查询样品: [TPS65580](#)

特性

- 高级 **D-CAP2™** 控制模式
 - 快速瞬态响应
 - 环路补偿无需外部部件
 - 与陶瓷输出电容器兼容
- 宽输入电压范围: **4.5V 至 18V**
- 输出电压范围: **0.76V 至 7.0V**
- 针对低占空比应用对高效集成场效应晶体管 (**FET**) 进行了优化
 - 对于 **2.5A** 电流为 **160mΩ** (高侧) 和 **130mΩ** (低侧)
 - 对于 **1.5A** 电流为 **250mΩ** (高侧) 和 **230mΩ** (低侧)
- 高初始基准精度
- 低侧 **R_{DS}** (接通) 无损耗电流感测
- 固定 **1.2ms** 软启动
- 非吸入预偏置软启动
- **700kHz** 开关频率
- 逐周期过流限制控制
- 过流限制 (**OCL**), 过压 (**OVP**), 欠压 (**UVP**), 欠压闭锁 (**UVLO**), 热关断 (**TSD**) 保护
- 针对过载保护的断续定时器
- 电源正常
- 带有集成式升压 **P** 通道金属氧化物半导体 (**PMOS**) 开关的自适应栅极驱动器
- 由于热补偿 **r_{ds}** (接通) 的值为 **4000ppm/°C**, 过流保护 (**OCP**) 恒定
- **20** 引脚散热薄型小外形尺寸封装 (**HTSSOP**)

应用范围

- 针对广泛应用的低功耗系统中的负载点调节
 - 数字电视电源
 - 网络互联家庭终端设备
 - 数字机顶盒 (**STB**)
 - **DVD** 播放器/刻录机
 - 游戏控制台和其它设备

说明

TPS65580 是一款三路、高级 D-CAP2™ 模式同步降压转换器。TPS65580 可帮助系统设计人员通过成本有效性、低组件数量和低待机电流解决方案来完成多种终端设备的电源总线调节器集。TPS65580 的主控制环路采用高级 D-CAP2™ 模式控制, 无需外部补偿组件即可提供快速的瞬态响应。TPS65580 能够采用诸如高分子有机半导体固体电容器 (POSCAP) 或者高分子聚合物电容器 (SP-CAP) 等低等效串联电阻 (ESR) 输出电容器和超低 ESR 陶瓷电容器。此器件在输入电压为 4.5V 至 18V 之间时提供便捷和有效的运行。

TPS65580 采用 4.4mm x 6.5mm 20 引脚 TSSOP (PWP) 封装, 并且额定温度范围为 -40°C 至 85°C 环境温度范围。



Please be aware that an important notice concerning availability, standard warranty, and use in critical applications of Texas Instruments semiconductor products and disclaimers thereto appears at the end of this data sheet.

D-CAP2, PowerPAD are trademarks of Texas Instruments.

PRODUCTION DATA information is current as of publication date. Products conform to specifications per the terms of the Texas Instruments standard warranty. Production processing does not necessarily include testing of all parameters.

Copyright © 2013, Texas Instruments Incorporated
English Data Sheet: [SLVSC29](#)



These devices have limited built-in ESD protection. The leads should be shorted together or the device placed in conductive foam during storage or handling to prevent electrostatic damage to the MOS gates.

HTSSOP APPLICATION DIAGRAM

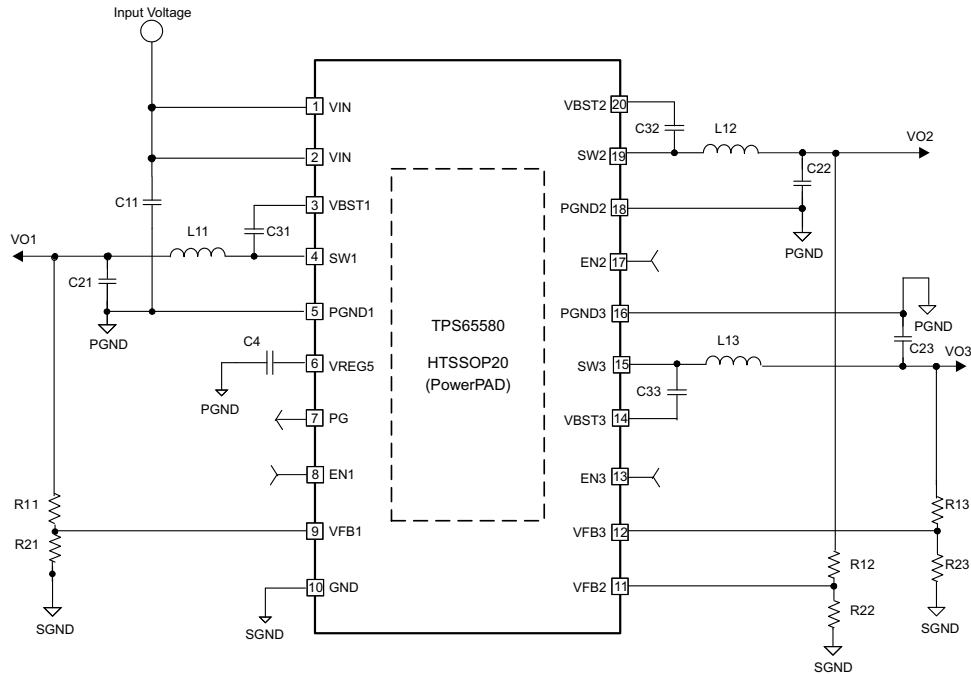

ORDERING INFORMATION

T _A	PACKAGE ⁽¹⁾	ORDERING PART NUMBER	PINS	OUTPUT SUPPLY	ECO PLAN
-40°C to 85°C	PWP	TPS65580PWPR	20	Tape-and-Reel	Green (RoHS & no Sb/Br)
		TPS65580PWP		Tube	

(1) For the most current package and ordering information, see the Package Option Addendum at the end of this document, or see the TI web site at www.ti.com

ABSOLUTE MAXIMUM RATINGS

over operating free-air temperature range (unless otherwise noted)⁽¹⁾⁽²⁾

		VALUE		UNIT
		MIN	MAX	
Input voltage range	VIN, EN1, EN2, EN3	-0.3	20	V
	VBST1, VBST2, VBST3	-0.3	26	
	VBST1, VBST2, VBST3 (10ns transient)	-0.3	28	
	VBST1–SW1, VBST2–SW2, VBST3–SW3	-0.3	6.5	
	VFB1, VFB2, VFB3	-0.3	6.5	
	SW1, SW2, SW3	-2	20	
	SW1, SW2, SW3 (10ns transient)	-3	22	
Output voltage range	VREG5, PG	-0.3	6.5	V
	PGND1, PGND2, PGND3	-0.3	0.3	
Electrostatic discharge	Human Body Model (HBM)		2	kV
	Charged Device Model (CDM)		500	V
T _A	Operating ambient temperature range	-40	85	°C
T _{STG}	Storage temperature range	-55	150	°C
T _J	Junction temperature range	-40	150	°C

- (1) Stresses beyond those listed under "absolute maximum ratings" may cause permanent damage to the device. These are stress ratings only and functional operation of the device at these or any other conditions beyond those indicated under "recommended operating conditions" are not implied. Exposure to absolute-maximum-rated conditions for extended periods may affect device reliability.
- (2) All voltages are with respect to IC GND terminal.

THERMAL INFORMATION

THERMAL METRIC ⁽¹⁾		TPS65580	UNITS
		PWP (20) PINS	
θ _{JA}	Junction-to-ambient thermal resistance	40.0	°C/W
θ _{JCtop}	Junction-to-case (top) thermal resistance	24.8	
θ _{JB}	Junction-to-board thermal resistance	21.3	
ψ _{JT}	Junction-to-top characterization parameter	0.8	
ψ _{JB}	Junction-to-board characterization parameter	21.1	
θ _{JCbot}	Junction-to-case (bottom) thermal resistance	1.7	

- (1) For more information about traditional and new thermal metrics, see the *IC Package Thermal Metrics application report*, [SPRA953](#).

RECOMMENDED OPERATING CONDITIONS

over operating free-air temperature range (unless otherwise noted)

		VALUES		UNIT
		MIN	MAX	
Supply input voltage range	VIN	4.5	18	V
Input voltage range	VBST1, VBST2, VBST3	-0.1	24	V
	VBST1, VBST2, VBST3 (10ns transient)	-0.1	27	
	VBST1–SW1, VBST2–SW2, VBST3–SW3	-0.1	5.7	
	VFB1, VFB2, VFB3	-0.1	5.7	
	EN1, EN2, EN3	-0.1	18	
	SW1, SW2, SW3	-1.0	18	
	SW1, SW2, SW3 (10ns transient)	-3	21	
Output voltage range	VREG5, PG	-0.1	5.7	V
	PGND1, PGND2, PGND3	-0.1	0.1	
T _A	Operating free-air temperature	-40	85	°C
T _J	Operating Junction Temperature	-40	150	°C

ELECTRICAL CHARACTERISTICS

over recommended free-air temperature range, VIN = 12 V (unless otherwise noted)

PARAMETER		CONDITIONS	MIN	TYP	MAX	UNIT
SUPPLY CURRENT						
I _{IN}	VIN supply current	T _A = 25°C, EN1 = EN2 = EN3 = 5 V, VFB1 = VFB2 = VFB3 = 1.0 V, Non-switching		2.9	3.6	mA
I _{VINSDN}	VIN shutdown current	T _A = 25°C, EN1 = EN2 = EN3 = 0 V		1.8	3	µA
VFB VOLTAGE						
V _{VFBTHLx}	VFBx threshold voltage ⁽¹⁾	T _A = 25°C, VO1=3.3V, VO2=1.2V, VO3=1.5V	752	764	776	mV
TC _{VFBx}	Temperature coefficient	On the basis of 25°C ⁽²⁾	-180		180	ppm/°C
VREG5 OUTPUT						
V _{UVREG5}	VREG5 UVLO Threshold	VREG5 Rising		4.0		V
		Hysteresis		0.3		
V _{VREG5}	VREG5 output voltage	T _A = 25°C, VIN = 12 V, I _{VREG} = 5 mA		5.5		V
I _{VREG5}	Output current	VIN = 6 V, T _A = 25°C	20			mA
MOSFETs						
r _{DS(on)H2}	High side switch resistance for 2.5A	T _A = 25°C, VBST2-SW2 = 5.5 V ⁽²⁾ , CH2		160		mΩ
r _{DS(on)L2}	Low side switch resistance for 2.5A	T _A = 25°C ⁽²⁾ , CH2		130		mΩ
r _{DS(on)Hx}	High side switch resistance for 1.5A	T _A = 25°C, VBSTx-SWx = 5.5 V ⁽²⁾ , CH1, CH3		250		mΩ
r _{DS(on)Lx}	Low side switch resistance for 1.5A	T _A = 25°C ⁽²⁾ , CH1, CH3		230		mΩ
MIN ON/OFF TIME and SWfrequency						
T _{ONminx}	Min On Time	T _A = 25°C, VOUT = 0.8V ⁽²⁾	80			ns
T _{OFFminx}	Min Off Time	T _A = 25°C, VFBx = 0.7 V ⁽²⁾		220		ns
F _{sw}	SW-frequency	T _A = 25°C		700		kHz
SOFT START						
T _{SS}	Soft-start time	Internal soft-start time		1.2		ms

(1) x means either 1 or 2 or 3, that is, VFBx means VFB1, VFB2 or VFB3.

(2) Specified by design. Not production tested.

ELECTRICAL CHARACTERISTICS (continued)

over recommended free-air temperature range, VIN = 12 V (unless otherwise noted)

PARAMETER		CONDITIONS	MIN	TYP	MAX	UNIT
POWER GOOD						
V _{PGTH}	PGx threshold	PG from lower VOx (going high)	84%			
		PG from higher VOx (going low)	116%			
R _{PG}	PGx pull-down resistance	VPGx = 0.5 V	50	85	130	Ω
T _{PGDLY}	PGx delay time	Delay for PGx going high	1.5			ms
		Delay for PGx going low	2			μs
T _{PGCOMPSS}	PGOOD comparator start-up delay	PGx comparator wake-up delay	2.8			ms
LOGIC THRESHOLD						
V _{ENH}	ENx H-level threshold voltage		2.0			V
V _{ENL}	ENx L-level threshold voltage		0.4			V
R _{ENx_IN}	ENx input resistance	ENx = 12 V	225	400	900	kΩ
CURRENT LIMIT						
I _{OCL1}	Current limit	Lout = 3.3 μH ⁽³⁾ , VOUT = 3.3 V	1.7	2.0	3.4	A
I _{OCL2}		Lout = 2.2 μH ⁽³⁾ VOUT = 1.2 V	2.9	3.5	4.9	A
I _{OCL3}		Lout = 2.2 μH ⁽³⁾ VOUT = 1.5 V	1.8	2.2	3.6	A
UNDER VOLTAGE PROTECTION						
V _{UVP}	Output UVP trip threshold	measured on VFBx	63%	68%	73%	
T _{UVPDEL}	Output UVP delay time		0.5			ms
T _{UVPEN}	Output UVP enable delay	UVP Enable Delay	2.8			ms
THERMAL SHUTDOWN						
T _{SD}	Thermal shutdown threshold	Shutdown temperature ⁽³⁾	155			°C
		Hysteresis ⁽³⁾	30			

(3) Specified by design. Not production tested.

DEVICE INFORMATION

HTSSOP PACKAGE
(TOP VIEW)

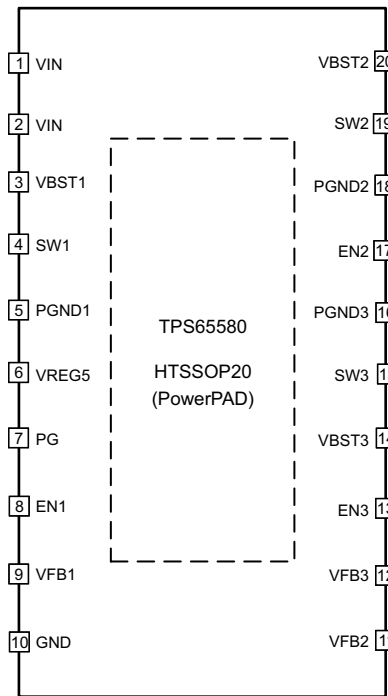

PIN FUNCTIONS⁽¹⁾

PIN		I/O	DESCRIPTION
NAME	TSSOP20		
VIN	1,2	I	Power input and connects to both high side NFET drains. Supply Input for 5.5V linear regulator.
VBST1, VBST2, VBST3	3, 14, 20	I	Supply input for high-side NFET gate drive circuit. Connect 0.1µF ceramic capacitor between VBSTx and SWx pins. An internal diode is connected between VREG5 and VBSTx
SW1, SW2, SW3	4,15,19	I/O	Switch node connections for both the high-side NFETs and low-side NFETs. Input of current comparator.
PGND1, PGND2, PGND3	5,16,18	I/O	Ground returns for low-side MOSFETs. Input of current comparator.
VREG5	6	O	Output of 5.5V linear regulator. Bypass to GND with a high-quality ceramic capacitor of at least 1.0µF. VREG5 is active when ENx is high level.
PG	7	O	Open drain power good output. Low means the output voltage is out of regulation.
EN1, EN2, EN3	8,13,17	I	Enable. Pull High to according converter.
VFB1, VFB2, VFB3	9,11,12	I	D-CAP2 feedback inputs. Connect to output voltage with resistor divider.
GND	10	I/O	Signal GND. Connect sensitive VFBx returns to GND at a single point.
Exposed Thermal Pad	Back side	I/O	Thermal pad of the package. Must be soldered to achieve appropriate dissipation. Must be connected to GND.

(1) x means either 1, 2 or 3, VFBx means VFB1, VFB2 or VFB3.

FUNCTIONAL BLOCK DIAGRAM

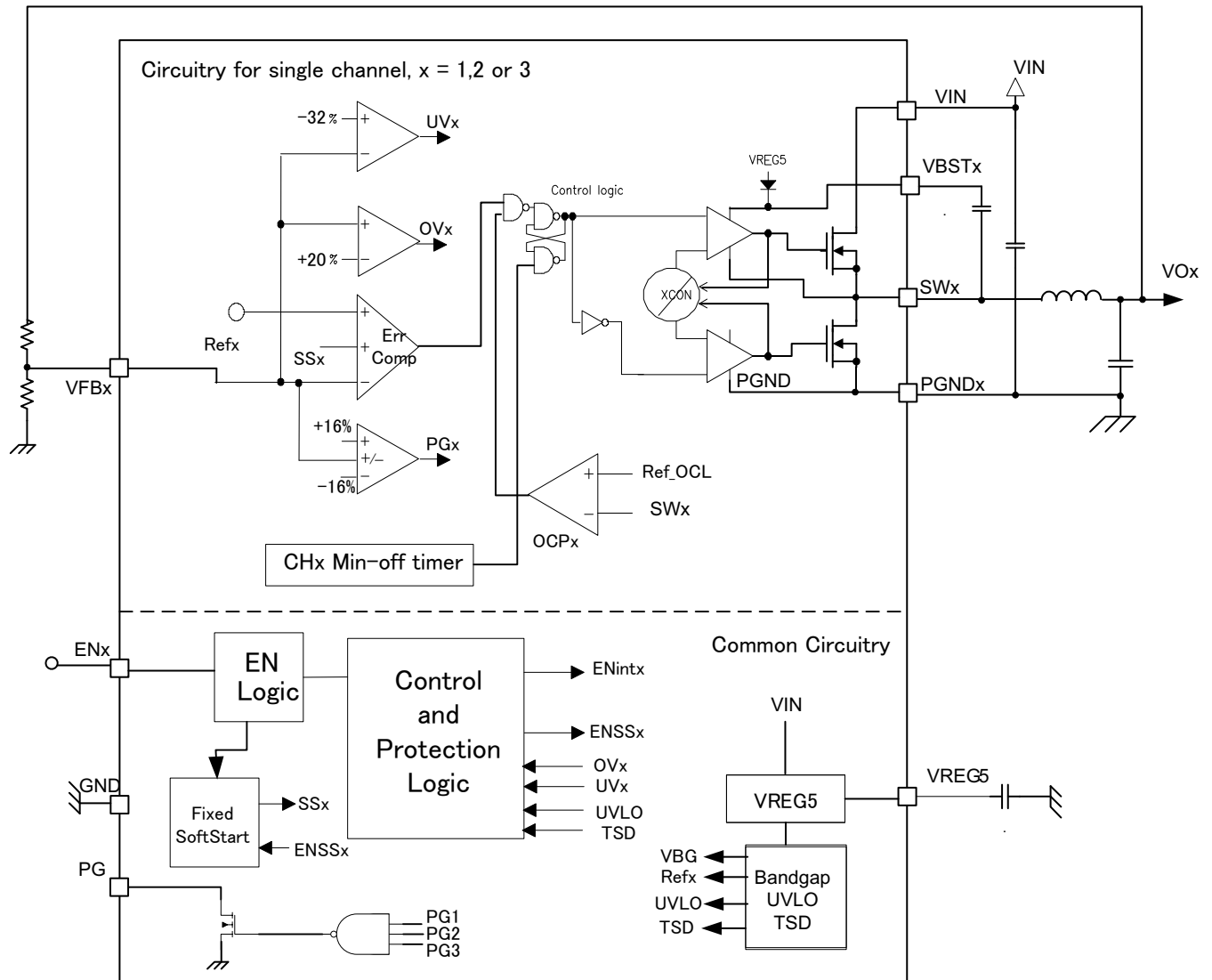

OVERVIEW

The TPS65580 is a 1.5A/2.5A/1.5A triple synchronous step-down (buck) converter with two integrated N-channel MOSFETs for each channel. It operates using Advanced D-CAP2™ control mode. The fast transient response of Advanced D-CAP2™ control reduces the required output capacitance to meet a specific level of performance. Proprietary internal circuitry allows the use of low ESR output capacitors including ceramic and special polymer types.

DETAILED DESCRIPTION

PWM Operation

The main control loop of the TPS65580 is a fixed switching frequency pulse width modulation (PWM) controller that supports a proprietary advanced D-CAP2™ mode control. Advanced D-CAP2™ mode control combines constant switching frequency with an internal compensation circuit and low external component count configuration with both low ESR and ceramic output capacitors. It is stable even with virtually no ripple at the output.

PWM Frequency and Adaptive On-Time Control

TPS65580 uses a advanced D-CAP2 mode control scheme and have a dedicated on board oscillator. The TPS65580 runs with fixed frequency of 700 kHz.

Soft Start and Pre-Biased Soft Start

The TPS65580 has an internal, 1.2ms, soft-start for each channel. When the ENx pin becomes high, an internal DAC begins ramping up the reference voltage to the PWM comparator. Smooth control of the output voltage is maintained during start up.

The TPS65580 contains a unique circuit to prevent current from being pulled from the output during startup if the output is pre-biased. When the soft-start commands a voltage higher than the pre-bias level (internal soft start becomes greater than internal feedback voltage V_{FB}), the controller slowly activates synchronous rectification by starting the first low side FET gate driver pulses with a narrow on-time. It then increments that on-time on a cycle-by-cycle basis until it coincides with the time dictated by (1-D), where D is the duty cycle of the converter. This scheme prevents the initial sinking of the pre-biased output, and ensures that the output voltage (VOx) starts and ramps up smoothly into regulation from pre-biased startup to normal mode operation..

Current Protection

The output over-current protection (OCP) is implemented using a cycle-by-cycle valley detect control circuit and using HICCUP mode over current protection. The switch current is monitored by measuring the low-side FET switch voltage between the SWx pin and PGNDx. This voltage is proportional to the switch current and the on-resistance of the FET. To improve accuracy, the voltage sensing is temperature compensated.

During the on time of the high-side FET switch, the switch current increases at a linear rate determined by V_{in} , V_{out} , the on-time and the output inductor value. During the on time of the low-side FET switch, this current decreases linearly. The average value of the switch current is the load current I_{ox} . If the sensed voltage on the low side FET is above the voltage proportional to the current limit, the converter keeps the low-side switch on until the measured voltage falls below the voltage corresponding to the current limit and a new switching cycle begins. In subsequent switching cycles, the on-time is set to the value determined for CCM and the current is monitored in the same manner.

Following are some important considerations for this type of over-current protection. The load current one half of the peak-to-peak inductor current higher than the over-current threshold. Also when the current is being limited, the output voltage tends to fall as the demanded load current may be higher than the current available from the converter. When the over current condition is removed, the output voltage returns to the regulated value. This protection is non-latching.

Hiccup Mode

Hiccup mode of operation protects the power supply from being damaged during an over-current fault condition. The operation of hiccup is as follows. If the OCL comparator circuit detects an over-current event the output voltage falls. When the feedback voltage falls below 68% of the reference voltage, the UVP comparator output goes high and an internal UVP delay counter begins counting. After counting UVP delay time, the TPS65580 shuts off the power supply for a given time (7x UVP Enable Delay Time) and then tries to re-start the power supply. If the over-load condition has been removed, the power supply starts and operates normally; otherwise, the TPS65580 detects another over-current event and shuts off the power supply again, repeating the previous cycle. Excess heat due to overload lasts for only a short duration in the hiccup cycle, therefore the junction temperature of the power devices is much lower.

POWERGOOD

The TPS65580 has power-good output that are measured on VFBx. The power-good function is activated after the soft-start has finished. If the all output voltages of 3 channels are within 16% of the target voltage, the internal comparator detects the power good state and the power good signal becomes high after 1.5ms delay. During start-up, this internal delay starts after 1.5ms of the UVP Enable delay time to avoid a glitch of power-good signal. Even if at least one of the feedback voltages of 3 channels goes outside of $\pm 16%$ of target value, the power-good signal becomes low after 2 μ s.

<Start up>

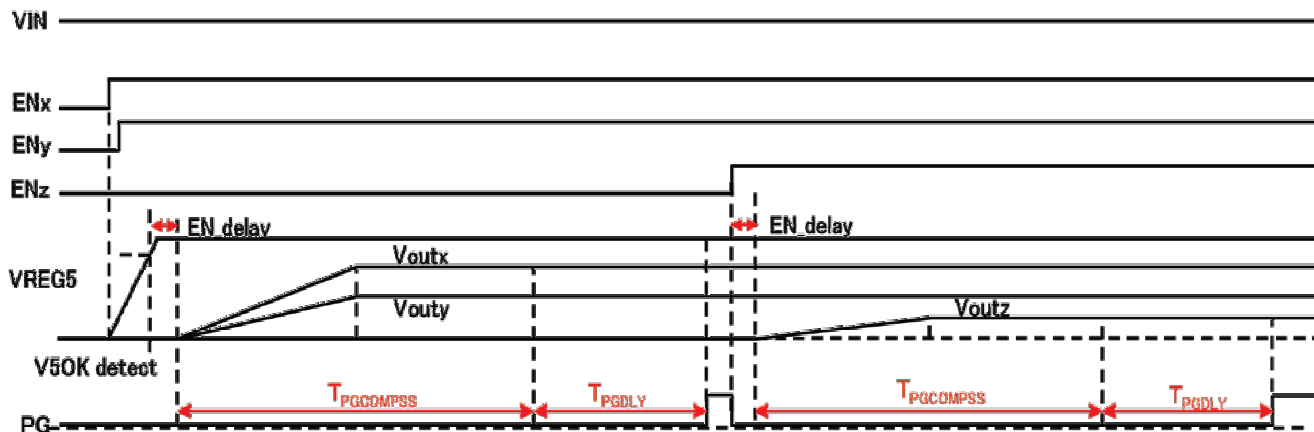

Figure 1. Start up

<Vout Transient>

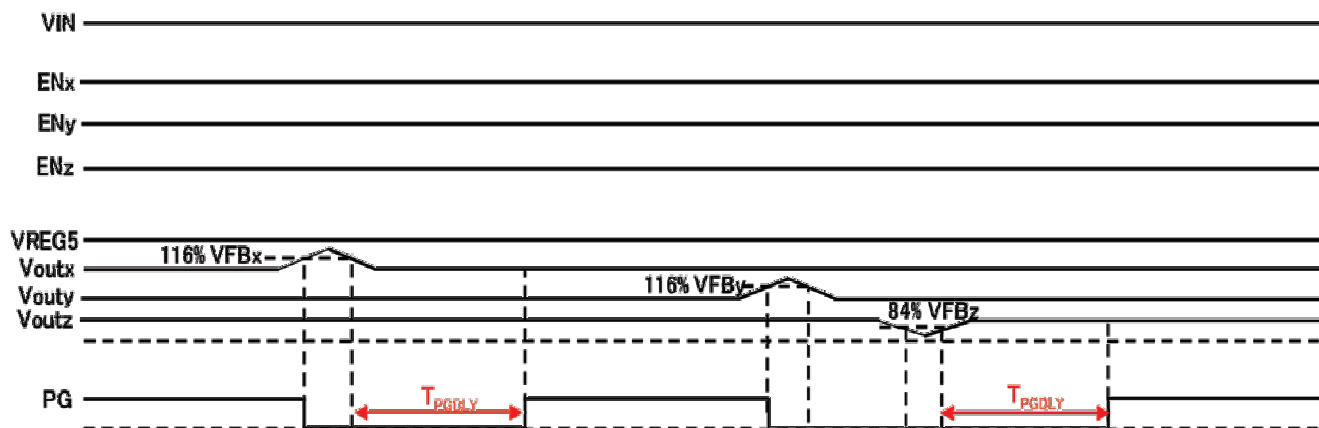

Figure 2. V_{OUT} Transient

<Power Down>

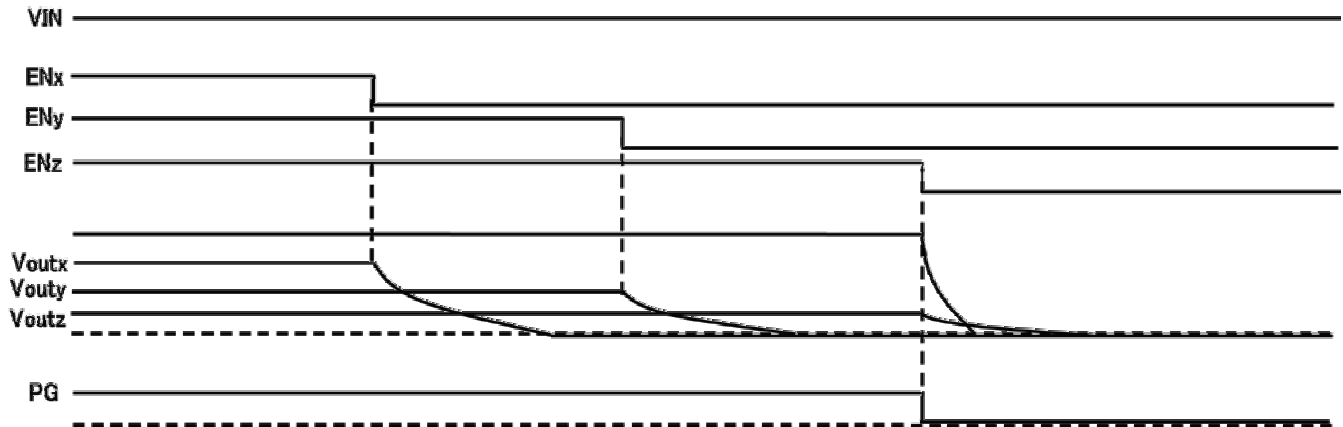

Figure 3. Power Down

UVLO Protection

Under voltage lock out protection (UVLO) monitors the voltage of the VREG5 pin. When the VREG5 voltage is lower than UVLO threshold voltage, the TPS65580 is shut down. As soon as the voltage increases above the UVLO threshold, the converter starts again.

Thermal Shutdown

TPS65580 monitors its temperature of itself. If the temperature exceeds the threshold value (typically 155°C), the device is shut down. When the temperature falls below the threshold, the IC starts again. When VIN starts up and VREG5 output voltage is below its nominal value, the thermal shutdown threshold is lower than 155°C. As long as VIN and VREG5 rise, T_J must be kept below 110°C.

TYPICAL CHARACTERISTICS

V_{IN} = 12 V, T_A = 25°C (unless otherwise noted)

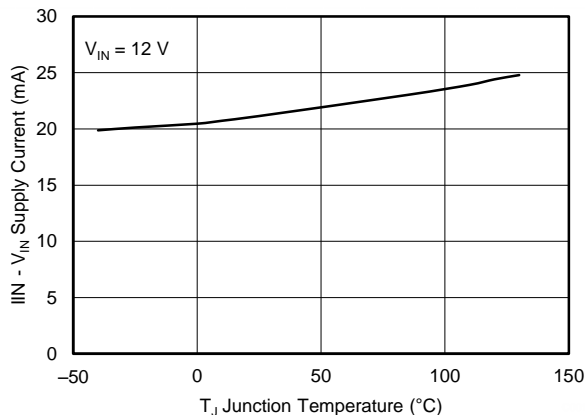

Figure 4. VIN Current vs Junction Temperature (VIN Current at ALL Channels Switching with I_O = 0A)

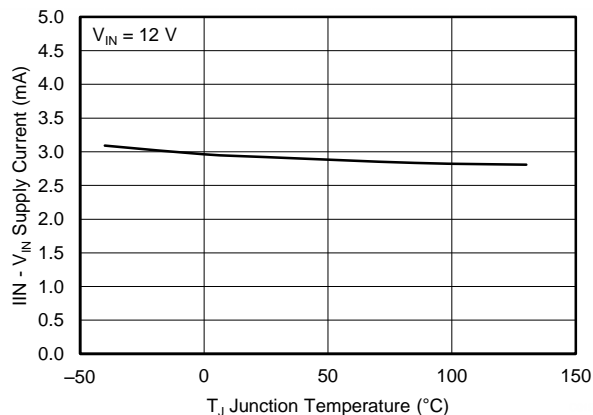

Figure 5. VIN Current vs Junction Temperature (VIN Current at ALL Channels Non-switching EN = H)

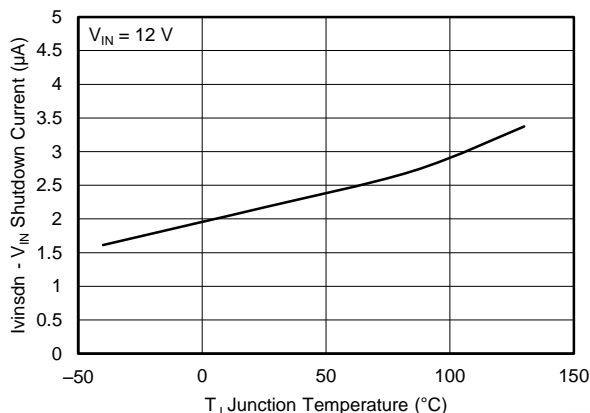

Figure 6. VIN Shutdown Current vs Junction Temperature

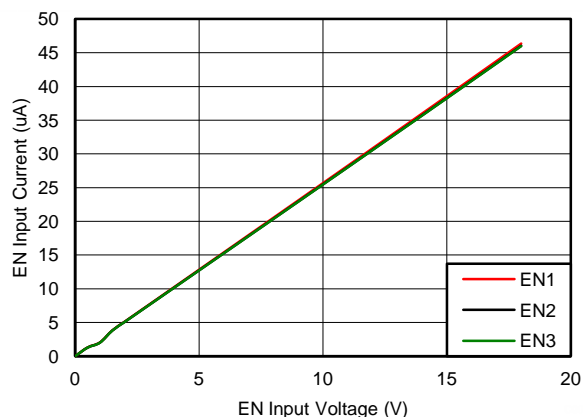

Figure 7. EN Current vs EN Voltage

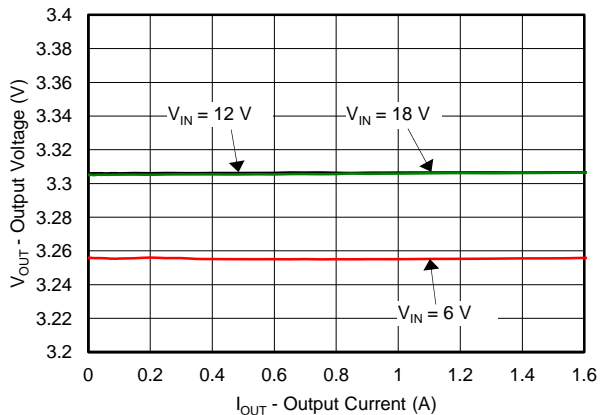

Figure 8. VOUT1 = 3.3V Output Voltage vs Output Current

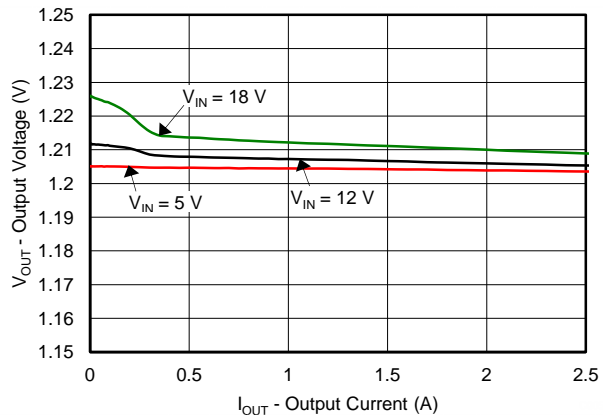

Figure 9. VOUT2 = 1.2V Output Voltage vs Output Current

TYPICAL CHARACTERISTICS (continued)

V_{IN} = 12 V, T_A = 25°C (unless otherwise noted)

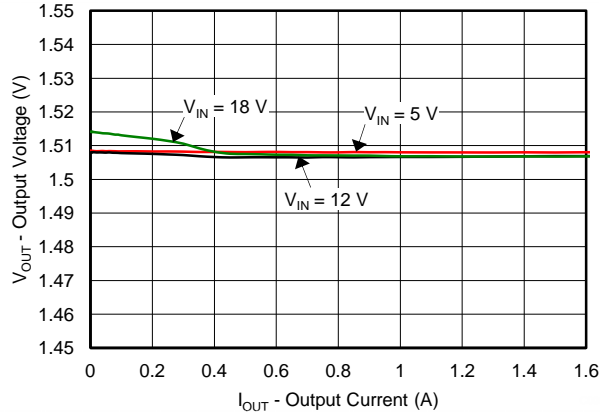

Figure 10. VOUT3 = 1.5V Output Voltage vs Output Current

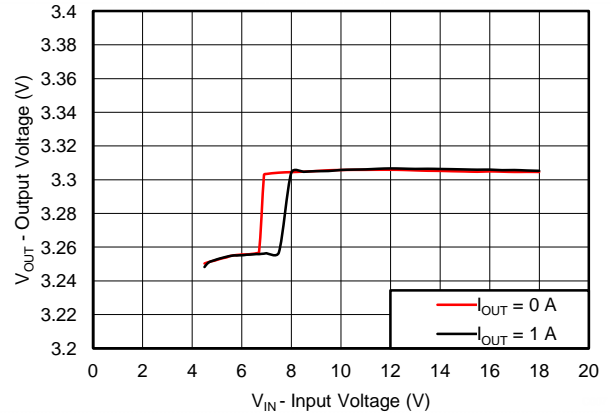

Figure 11. VOUT1 = 3.3V Output Voltage vs Input Voltage

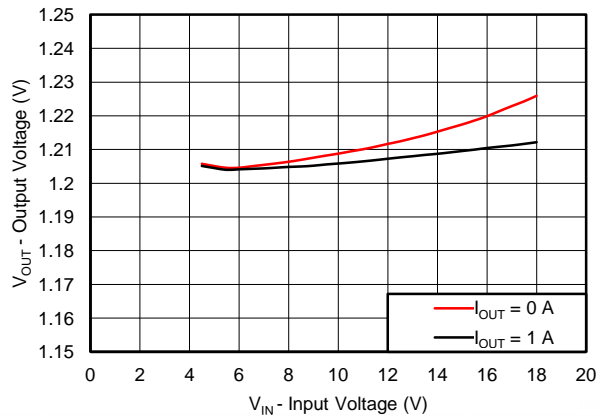

Figure 12. VOUT2 = 1.2V Output Voltage vs Input Voltage

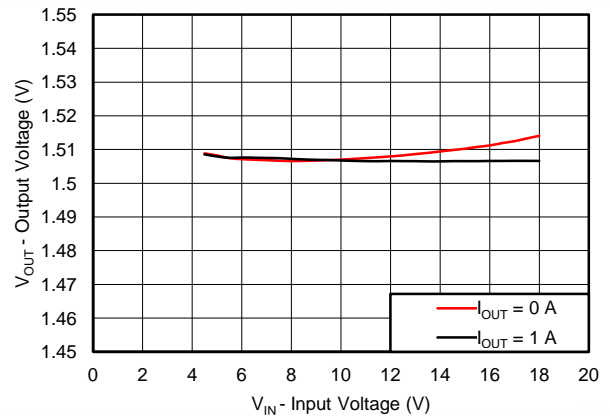

Figure 13. VOUT3 = 1.5V Output Voltage vs Input Voltage

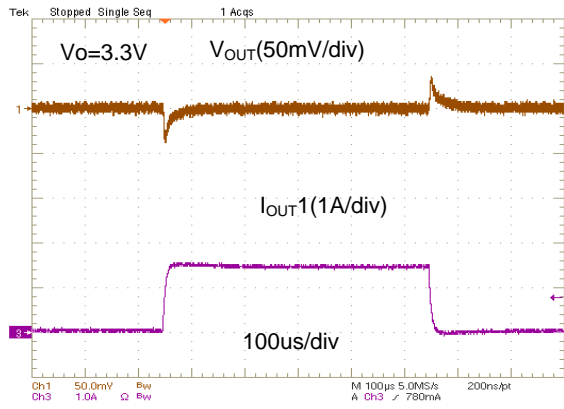

Figure 14. VOUT1 = 3.3V, 0A to 1.5A Load Transient Response

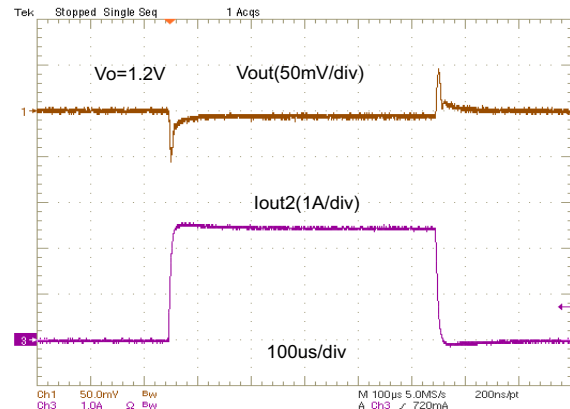

Figure 15. VOUT2 = 1.2V, 0A to 2.5A Load Transient Response

TYPICAL CHARACTERISTICS (continued)

VIN = 12 V, TA = 25°C (unless otherwise noted)

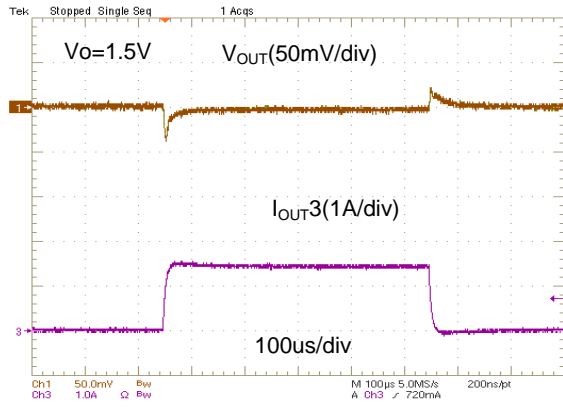

Figure 16. VOUT3 = 1.5V, 0A to 1.5A Load Transient Response

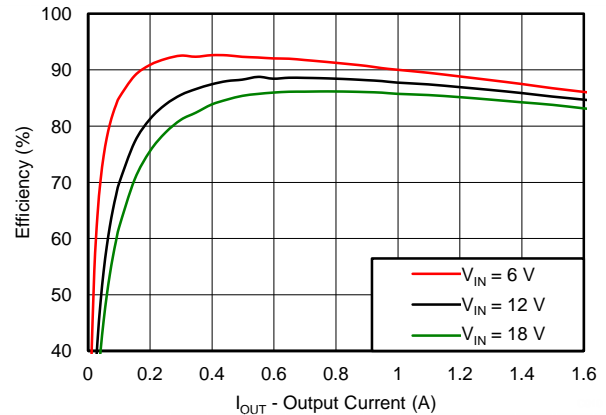

Figure 17. VOUT1 = 3.3V Light Load Efficiency vs Output Current

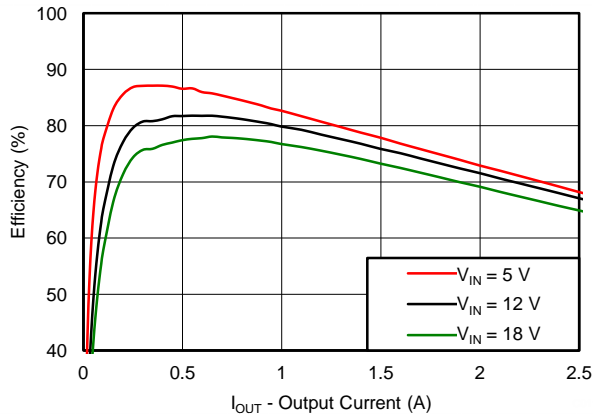

Figure 18. VOUT2 = 1.2V Light Load Efficiency vs Output Current

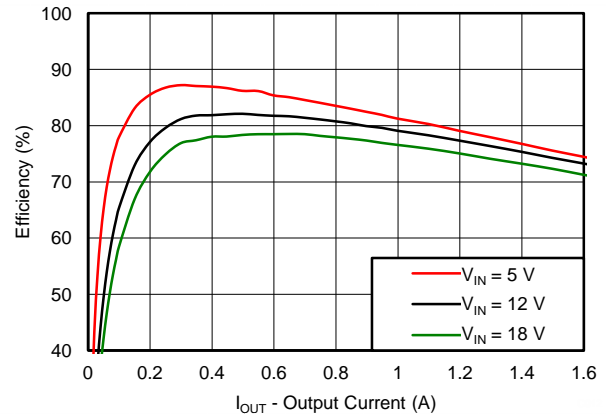

Figure 19. VOUT3 = 1.5V, Light Load Efficiency vs Output Current

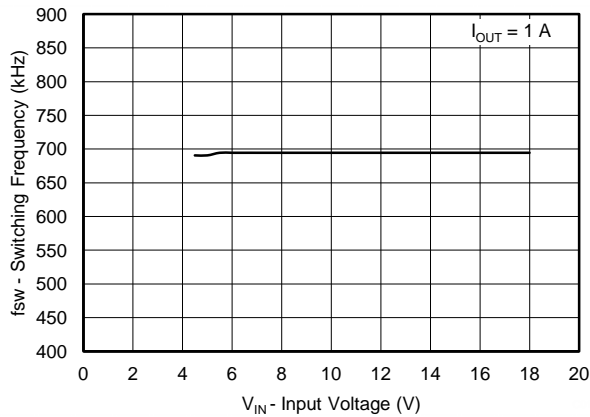

Figure 20. VOUT1 = 3.3V Switching Frequency vs Input Voltage

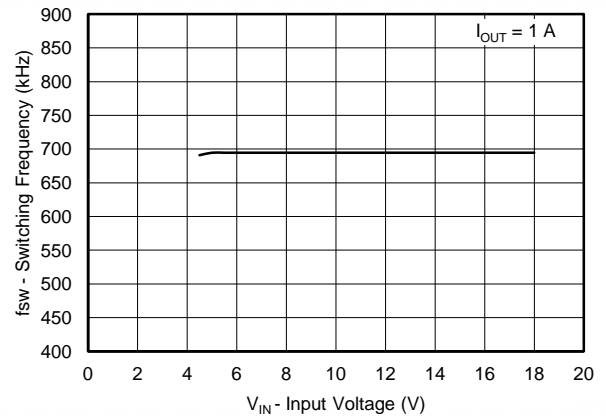

Figure 21. VOUT2 = 1.2V Switching Frequency vs Input Voltage

TYPICAL CHARACTERISTICS (continued)

V_{IN} = 12 V, T_A = 25°C (unless otherwise noted)

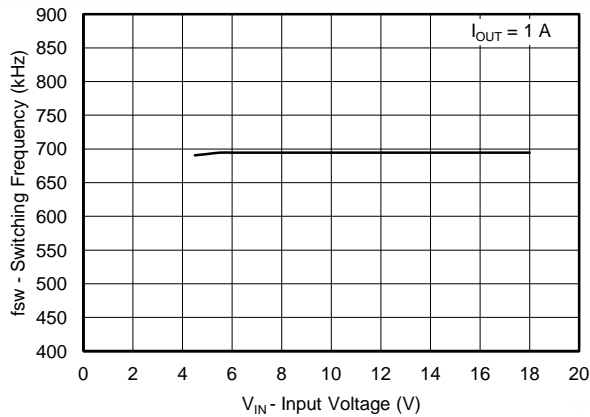

Figure 22. V_{OUT3} = 1.5V Switching Frequency vs Input Voltage

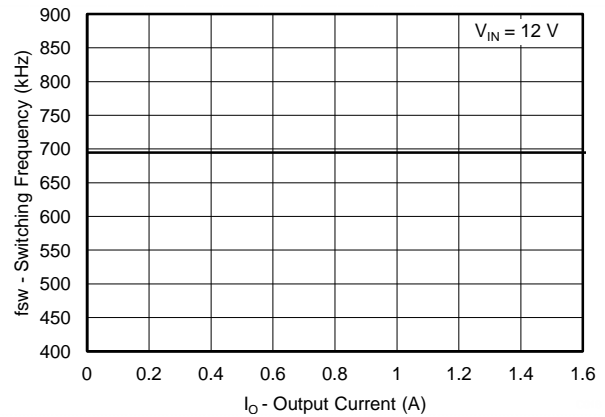

Figure 23. V_{OUT1} = 3.3V Switching Frequency vs Output current

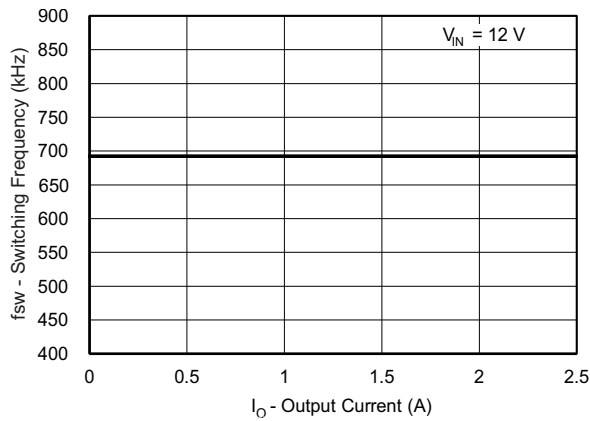

Figure 24. V_{OUT2} = 1.2V, Switching Frequency vs Output Current

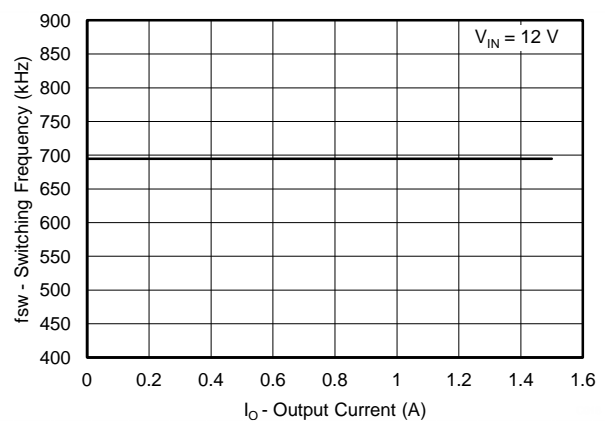

Figure 25. V_{OUT3} = 1.5V, Switching Frequency vs Output Current

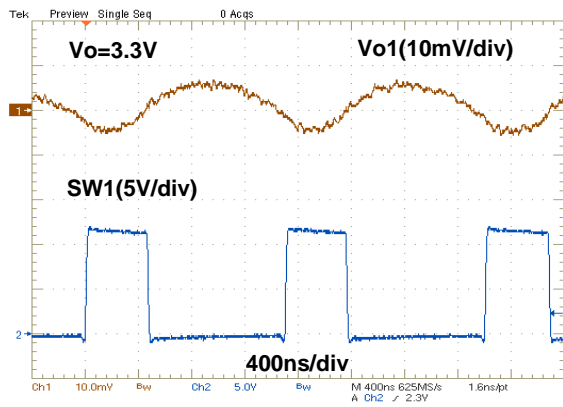

Figure 26. V_{OUT1} = 3.3V, VO1 Ripple Voltage at I_{OUT1} = 1.5A

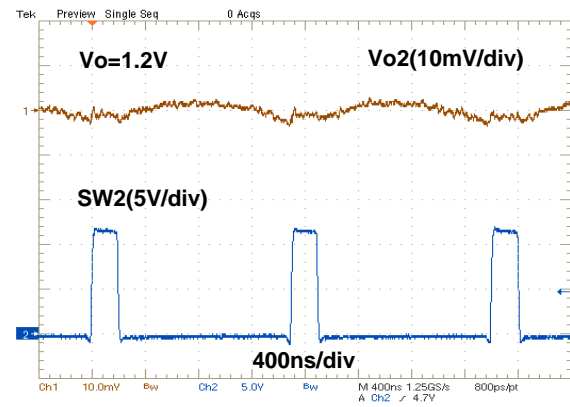

Figure 27. V_{OUT2} = 1.2V, Ripple Voltage at I_{OUT2} = 2.5A

TYPICAL CHARACTERISTICS (continued)

VIN = 12 V, TA = 25°C (unless otherwise noted)

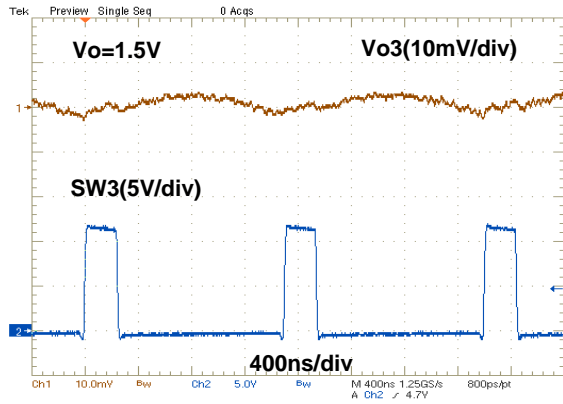

Figure 28. VOUT3 = 1.2V, Ripple Voltage at IOUT3 = 1.5A

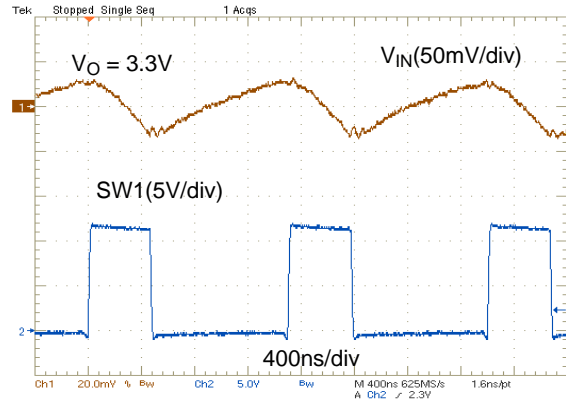

Figure 29. VOUT1 = 3.3V, VIN Ripple Voltage at IOUT1 = 1.5A

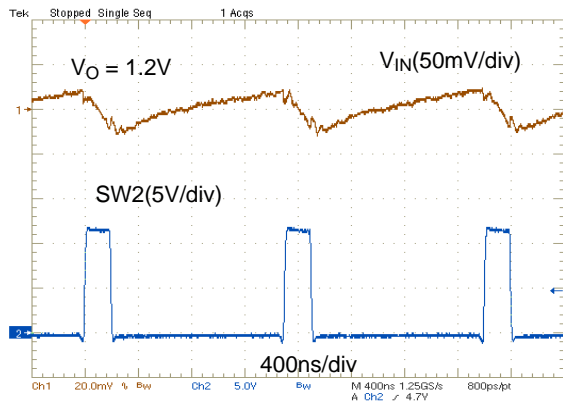

Figure 30. VOUT2 = 1.2V VIN Ripple at IOUT2 = 2.5A

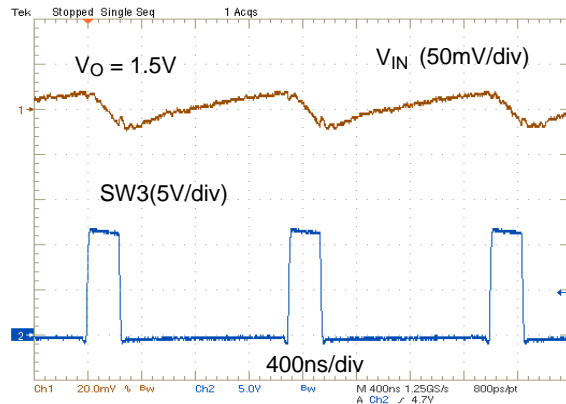

Figure 31. VOUT3 = 1.5V VIN Ripple at IOUT3 = 1.5A

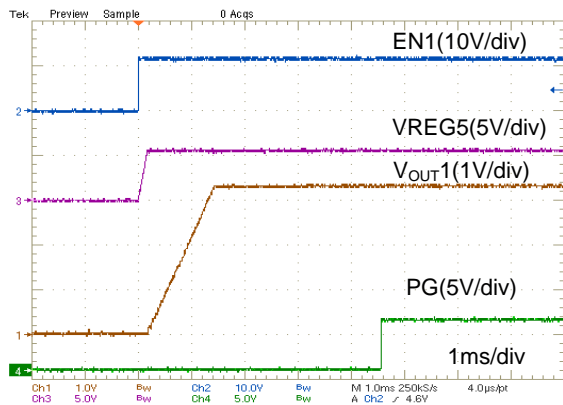

Figure 32. VOUT1 = 3.3V Soft-Start IOUT1 = 1.5A

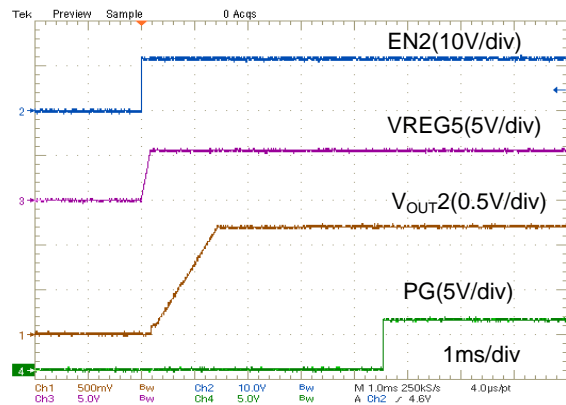

Figure 33. VOUT2 = 1.2V Soft-Start IOUT2 = 2.5A

TYPICAL CHARACTERISTICS (continued)

VIN = 12 V, TA = 25°C (unless otherwise noted)

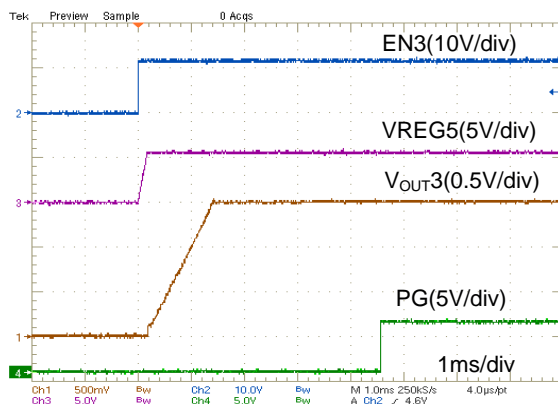

Figure 34. VOUT3 = 1.5V Soft-Start IOU3 = 1.5A

DESIGN GUIDE

Step By Step Design Procedure

To begin the design process, you must know a few application parameters:

- Input voltage range
- Output voltage
- Output current

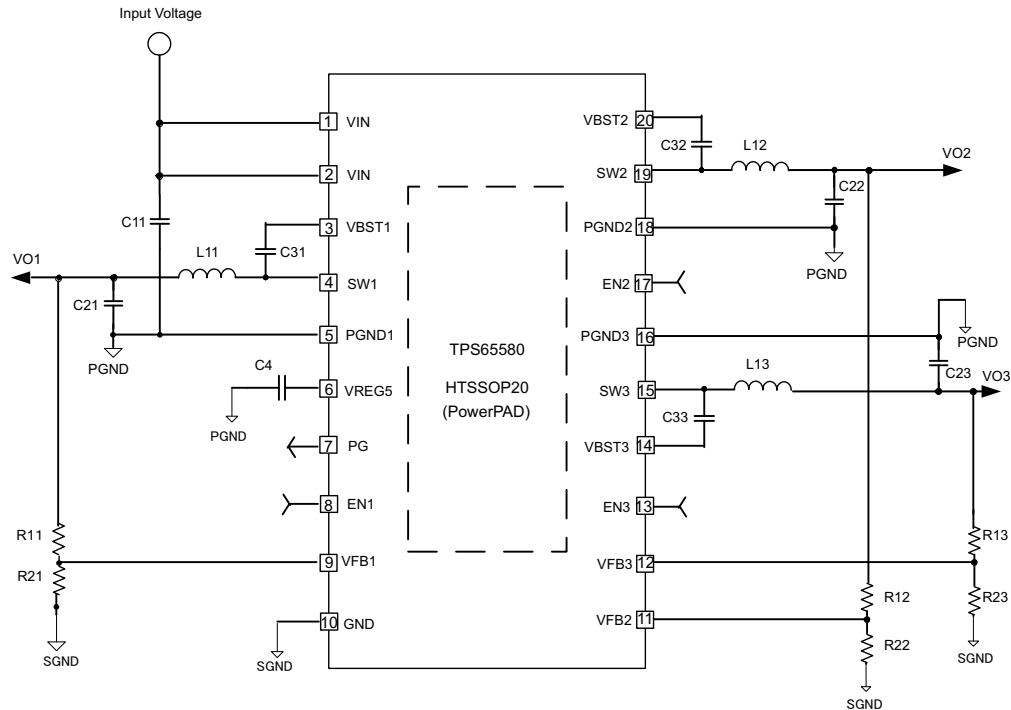

Figure 35. Schematic Diagram for the Design Example at $V_{in}=12V$

Output Voltage Resistors Selection

The output voltage is set with a resistor divider from the output node to the VFBx pin. It is recommended to use 1% tolerance or better divider resistors. Start by using Equation 1 to calculate V_{OX} .

$$V_{OX} = 0.764 \times \left(1 + \frac{R1x}{R2x} \right) \quad (1)$$

Output Filter Selection

The output filter used with the TPS65580 is an LC circuit. This LC filter has double pole at:

$$F_P = \frac{1}{2\pi\sqrt{L_{1X} \times C_{2X}}} \quad (2)$$

At low frequencies, the overall loop gain is set by the output set-point resistor divider network and the internal gain of the TPS65580. The low frequency phase is 180 degrees. At the output filter pole frequency, the gain rolls off at a -40 dB per decade rate and the phase drops rapidly. Advanced D-CAP2™ introduces a high frequency zero that reduces the gain roll off to -20 dB per decade and increases the phase to 90 degrees one decade above the zero frequency. The inductor and capacitor selected for the output filter must be selected so that the double pole of Equation 2 is located below the high frequency zero but close enough that the phase boost provided by the high frequency zero provides adequate phase margin for a stable circuit. To meet this requirement use the values recommended in Table 1.

Table 1. Recommended Component Values

OUTPUT VOLTAGE (V)	R1x (kΩ)	R2x (kΩ)	L1x (μH)	C2x (μF)
1	6.81	2.2	1.5 to 3.3	22 - 68
1.05	8.25	2.2	1.5 to 3.3	22 - 68
1.2	1.27	2.2	1.5 to 3.3	22 - 68
1.5	2.15	2.2	1.5 to 3.3	22 - 68
1.8	30.1	2.2	1.5 to 3.3	22 - 68
2.5	49.9	2.2	2.2 to 4.7	22 - 68
3.3	7.36	2.2	2.2 to 4.7	22 - 68
5	124	2.2	2.2 to 4.7	22 - 68
6.5	165	2.2	2.2 to 4.7	22 - 68

The inductor peak-to-peak ripple current, peak current and RMS current are calculated using [Equation 3](#), [Equation 4](#) and [Equation 5](#). The inductor saturation current rating must be greater than the calculated peak current and the RMS or heating current rating must be greater than the calculated RMS current.

For the calculations, use 700 kHz as the switching frequency, f_{SW} . Make sure the chosen inductor is rated for the peak current of [Equation 4](#) and the RMS current of [Equation 5](#).

$$\Delta I_{L1X} = \frac{V_{OX}}{V_{IN(MAX)}} \times \frac{V_{IN(MAX)} - V_{OX}}{L1x \times f_{SW}} \quad (3)$$

$$I_{L1XPEAK} = I_{OX} + \frac{\Delta I_{L1X}}{2} \quad (4)$$

$$I_{L1X(RMS)} = \sqrt{I_{OX}^2 + \frac{1}{12} \Delta I_{L1X}^2} \quad (5)$$

For the above design example, the calculated peak current is 2.46 A and the calculated RMS current is 2.02 A. for Vo1. The inductor used is a TDK CLF7045-1R5N with a rated current of 7.3 A based on the inductance change and of 4.9A based on the temperature rise.

The capacitor value and ESR determines the amount of output voltage ripple. The TPS65580 is intended for use with ceramic or other low ESR capacitors. Recommended values range from 22μF to 68μF. Use [Equation 6](#) to determine the required RMS current rating for the output capacitor(s).

$$I_{C2X(RMS)} = \frac{V_{OX} \times (V_{IN} - V_{OX})}{\sqrt{12} \times V_{IN} \times L_{IX} \times f_{SW}} \quad (6)$$

For this design two TDK C3216X5R0J226M 22μF output capacitors are used. The typical ESR is 2 mΩ each. The calculated RMS current is 0.19A and each output capacitor is rated for 4A.

Input Capacitor Selection

The TPS65580 requires an input decoupling capacitor and a bulk capacitor is needed depending on the application. A ceramic capacitor over 10μF × 2 is recommended for the decoupling capacitor. Accordingly, 0.1 μF ceramic capacitors from pin 1 to ground is recommended to improve the stability and reduce the SWx node overshoots. The capacitor voltage rating needs to be greater than the maximum input voltage.

Bootstrap Capacitor Selection

A 0.1 μF ceramic capacitors must be connected between the VBSTx and SWx pins for proper operation. It is recommended to use ceramic capacitors with a dielectric of X5R or better.

VREG5 Capacitor Selection

A 1 μF ceramic capacitor must be connected between the VREG5 and GND pins for proper operation. It is recommended to use a ceramic capacitor with a dielectric of X5R or better.

Thermal Information

This 20-pin PWP package incorporates an exposed thermal pad that is designed to be directly to an external heatsink. The thermal pad must be soldered directly to the printed board (PCB). After soldering, the PCB can be used as a heatsink. In addition, through the use of thermal vias, the thermal pad can be attached directly to the appropriate copper plane shown in the electrical schematic for the device, or alternatively, can be attached to a special heatsink structure designed into the PCB. This design optimizes the heat transfer from the integrated circuit (IC).

For additional information on the exposed thermal pad and how to use the advantage of its heat dissipating abilities, refer to the Technical Brief, *PowerPAD™ Thermally Enhanced Package*, Texas Instruments Literature No. [SLMA002](#) and Application Brief, *PowerPAD™ Made Easy*, Texas Instruments Literature No. [SLMA004](#).

The exposed thermal pad dimensions for this package are shown in the following illustration.

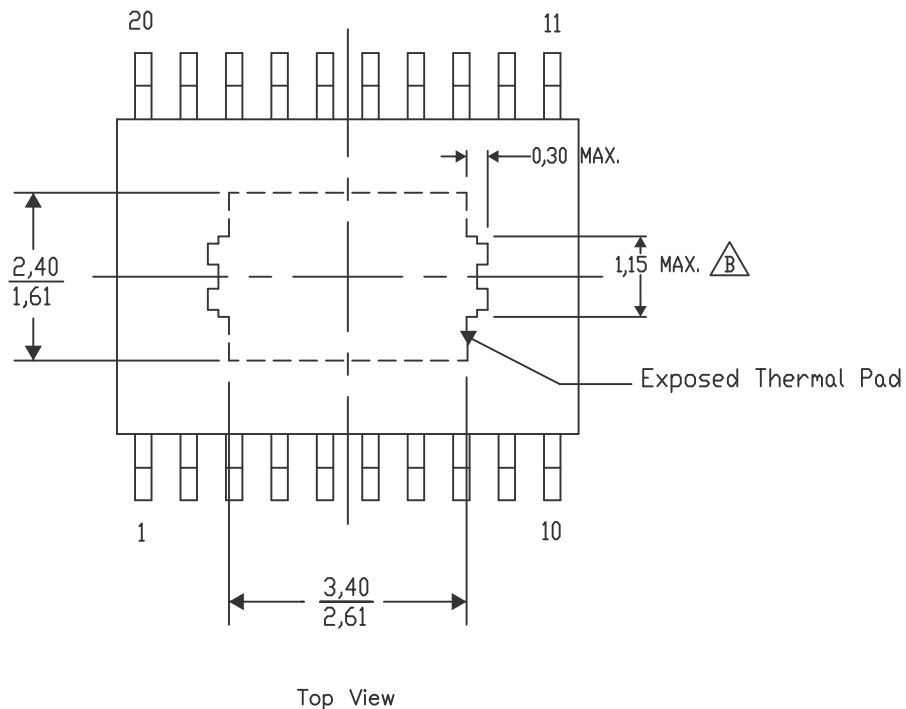

NOTE: A. All linear dimensions are in millimeters
 B. Exposed tie strap features may not be present.

Figure 36. Thermal Pad Dimensions

Layout Considerations

1. Keep the input current loop as small as possible. And avoid the input switching current through the thermal pad.
2. Keep the SW node as physically small and short as possible to minimize parasitic capacitance and inductance and to minimize radiated emissions. Kelvin connections should be brought from the output to the feedback pin of the device.
3. Keep analog and non-switching components away from switching components.
4. Make a single point connection from the signal ground to power ground.
5. Do not allow switching currents to flow under the device.
6. Keep the pattern lines for VIN and PGND broad.
7. Exposed pad of device must be connected to PGND with solder.
8. VREG5 capacitor should be placed near the device, and connected to PGND.
9. Output capacitors should be connected with a broad pattern to the PGND.
10. Voltage feedback loops should be as short as possible, and preferably with ground shield.
11. Kelvin connections should be brought from the output to the feedback pin of the device.
12. Providing sufficient vias is preferable for VIN, SW and PGND connection.
13. PCB pattern for VIN, SW, and PGND should be as broad as possible.
14. VIN Capacitor should be placed as near as possible to the device.

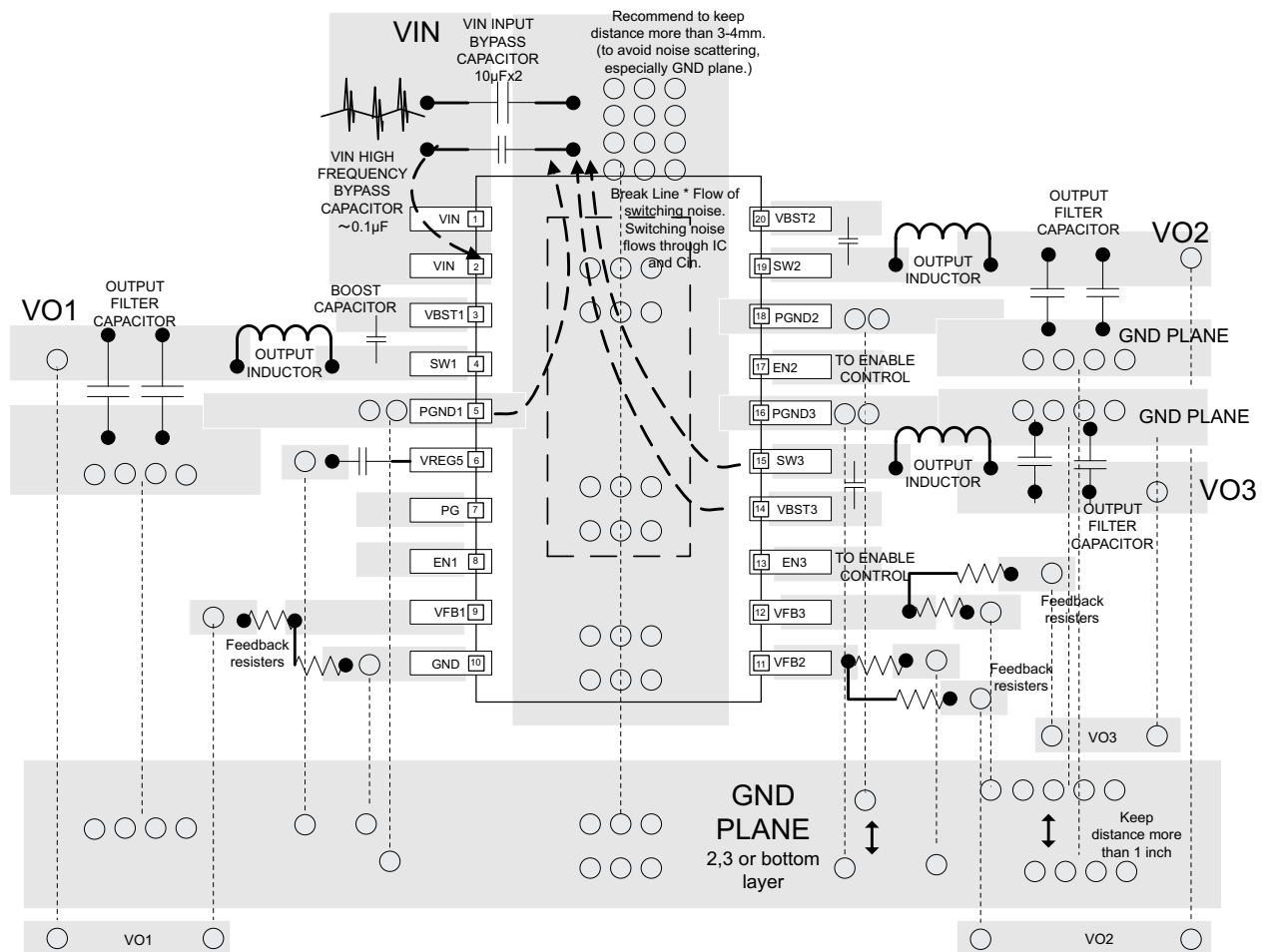

Figure 37. TPS65580 Layout

PACKAGING INFORMATION

Orderable Device	Status (1)	Package Type	Package Drawing	Pins	Package Qty	Eco Plan (2)	Lead finish/ Ball material (6)	MSL Peak Temp (3)	Op Temp (°C)	Device Marking (4/5)	Samples
TPS65580PWP	ACTIVE	HTSSOP	PWP	20	70	RoHS & Green	NIPDAU	Level-2-260C-1 YEAR	-40 to 125	TPS65580	Samples
TPS65580PWPR	ACTIVE	HTSSOP	PWP	20	2000	RoHS & Green	NIPDAU	Level-2-260C-1 YEAR	-40 to 125	TPS65580	Samples

(1) The marketing status values are defined as follows:

ACTIVE: Product device recommended for new designs.

LIFEBUY: TI has announced that the device will be discontinued, and a lifetime-buy period is in effect.

NRND: Not recommended for new designs. Device is in production to support existing customers, but TI does not recommend using this part in a new design.

PREVIEW: Device has been announced but is not in production. Samples may or may not be available.

OBsolete: TI has discontinued the production of the device.

(2) **RoHS:** TI defines "RoHS" to mean semiconductor products that are compliant with the current EU RoHS requirements for all 10 RoHS substances, including the requirement that RoHS substance do not exceed 0.1% by weight in homogeneous materials. Where designed to be soldered at high temperatures, "RoHS" products are suitable for use in specified lead-free processes. TI may reference these types of products as "Pb-Free".

RoHS Exempt: TI defines "RoHS Exempt" to mean products that contain lead but are compliant with EU RoHS pursuant to a specific EU RoHS exemption.

Green: TI defines "Green" to mean the content of Chlorine (Cl) and Bromine (Br) based flame retardants meet JS709B low halogen requirements of <=1000ppm threshold. Antimony trioxide based flame retardants must also meet the <=1000ppm threshold requirement.

(3) MSL, Peak Temp. - The Moisture Sensitivity Level rating according to the JEDEC industry standard classifications, and peak solder temperature.

(4) There may be additional marking, which relates to the logo, the lot trace code information, or the environmental category on the device.

(5) Multiple Device Markings will be inside parentheses. Only one Device Marking contained in parentheses and separated by a "~" will appear on a device. If a line is indented then it is a continuation of the previous line and the two combined represent the entire Device Marking for that device.

(6) Lead finish/Ball material - Orderable Devices may have multiple material finish options. Finish options are separated by a vertical ruled line. Lead finish/Ball material values may wrap to two lines if the finish value exceeds the maximum column width.

Important Information and Disclaimer:The information provided on this page represents TI's knowledge and belief as of the date that it is provided. TI bases its knowledge and belief on information provided by third parties, and makes no representation or warranty as to the accuracy of such information. Efforts are underway to better integrate information from third parties. TI has taken and continues to take reasonable steps to provide representative and accurate information but may not have conducted destructive testing or chemical analysis on incoming materials and chemicals. TI and TI suppliers consider certain information to be proprietary, and thus CAS numbers and other limited information may not be available for release.

In no event shall TI's liability arising out of such information exceed the total purchase price of the TI part(s) at issue in this document sold by TI to Customer on an annual basis.

MECHANICAL DATA

PWP (R-PDSO-G20)

PowerPAD™ PLASTIC SMALL OUTLINE



4073225-4/1 05/11

- NOTES:
- All linear dimensions are in millimeters.
 - This drawing is subject to change without notice.
 - Body dimensions do not include mold flash or protrusions. Mold flash and protrusion shall not exceed 0.15 per side.
 - This package is designed to be soldered to a thermal pad on the board. Refer to Technical Brief, PowerPad Thermally Enhanced Package, Texas Instruments Literature No. SLMA002 for information regarding recommended board layout. This document is available at www.ti.com <<http://www.ti.com>>.
 - See the additional figure in the Product Data Sheet for details regarding the exposed thermal pad features and dimensions.
 - Falls within JEDEC MO-153

PowerPAD is a trademark of Texas Instruments.

THERMAL PAD MECHANICAL DATA

PWP (R-PDSO-G20) PowerPAD™ SMALL PLASTIC OUTLINE

THERMAL INFORMATION

This PowerPAD™ package incorporates an exposed thermal pad that is designed to be attached to a printed circuit board (PCB). The thermal pad must be soldered directly to the PCB. After soldering, the PCB can be used as a heatsink. In addition, through the use of thermal vias, the thermal pad can be attached directly to the appropriate copper plane shown in the electrical schematic for the device, or alternatively, can be attached to a special heatsink structure designed into the PCB. This design optimizes the heat transfer from the integrated circuit (IC).

For additional information on the PowerPAD package and how to take advantage of its heat dissipating abilities, refer to Technical Brief, PowerPAD Thermally Enhanced Package, Texas Instruments Literature No. SLMA002 and Application Brief, PowerPAD Made Easy, Texas Instruments Literature No. SLMA004. Both documents are available at www.ti.com.

The exposed thermal pad dimensions for this package are shown in the following illustration.



Top View

Exposed Thermal Pad Dimensions

4206332-15/AO 01/16

NOTE: A. All linear dimensions are in millimeters

 Exposed tie strap features may not be present.

PowerPAD is a trademark of Texas Instruments

PWP (R-PDSO-G20)

PowerPAD™ PLASTIC SMALL OUTLINE



- NOTES:
- A. All linear dimensions are in millimeters.
 - B. This drawing is subject to change without notice.
 - C. Customers should place a note on the circuit board fabrication drawing not to alter the center solder mask defined pad.
 - D. This package is designed to be soldered to a thermal pad on the board. Refer to Technical Brief, PowerPad Thermally Enhanced Package, Texas Instruments Literature No. SLMA002, SLMA004, and also the Product Data Sheets for specific thermal information, via requirements, and recommended board layout. These documents are available at www.ti.com <<http://www.ti.com>>. Publication IPC-7351 is recommended for alternate designs.
 - E. Laser cutting apertures with trapezoidal walls and also rounding corners will offer better paste release. Customers should contact their board assembly site for stencil design recommendations. Example stencil design based on a 50% volumetric metal load solder paste. Refer to IPC-7525 for other stencil recommendations.
 - F. Customers should contact their board fabrication site for solder mask tolerances between and around signal pads.

重要声明和免责声明

TI 均以“原样”提供技术性及其可靠性数据（包括数据表）、设计资源（包括参考设计）、应用或其他设计建议、网络工具、安全信息和其他资源，不保证其中不含任何瑕疵，且不做任何明示或暗示的担保，包括但不限于对适销性、适合某特定用途或不侵犯任何第三方知识产权的暗示担保。

所述资源可供专业开发人员应用TI 产品进行设计使用。您将对以下行为独自承担全部责任：(1) 针对您的应用选择合适的TI 产品；(2) 设计、验证并测试您的应用；(3) 确保您的应用满足相应标准以及任何其他安全、安保或其他要求。所述资源如有变更，恕不另行通知。TI 对您使用所述资源的授权仅限于开发资源所涉及TI 产品的相关应用。除此之外不得复制或展示所述资源，也不提供其它TI 或任何第三方的知识产权授权许可。如因使用所述资源而产生任何索赔、赔偿、成本、损失及债务等，TI 对此概不负责，并且您须赔偿由此对TI 及其代表造成的损害。

TI 所提供产品均受TI 的销售条款 (<http://www.ti.com.cn/zh-cn/legal/termsofsale.html>) 以及ti.com.cn上或随附TI产品提供的其他可适用条款的约束。TI提供所述资源并不扩展或以其他方式更改TI 针对TI 产品所发布的可适用的担保范围或担保免责声明。

邮寄地址：上海市浦东新区世纪大道 1568 号中建大厦 32 楼，邮政编码：200122

Copyright © 2020 德州仪器半导体技术（上海）有限公司