

TPS92550 450mA 14W Constant Current Buck LED Driver Micro-Module

Check for Samples: [TPS92550](#)

FEATURES

- Integrated all Power Components Including the Power Inductor
- Wide Input Voltage Range : 4.5V–36V
- Constant Switching Frequency at 400kHz
- High Contrast Ratio (Minimum dimming current pulse width < 16µs)
- Drives up to 10 LEDs in Series at 36V Input
- ±3.6% Typical LED Current Accuracy
- LED Current Adjustable from 300mA to 450mA
- Up to 96% Efficiency
- TPS92550 Modules can be Connected in Parallel for Higher Current Operation
- Input Under-Voltage Lock-Out (UVLO)
- Compatible with Ceramic and Low ESR Capacitors
- Low Electro Magnetic Interference(EMI) Complies with EN55015 Standard ⁽¹⁾
- LED Open and Short Circuit Protections
- Thermal Shutdown and RoHS Compliant
- –40°C to +125°C Junction Temperature Range

APPLICATIONS

- General Lighting, Desk Lamps
 - Cabinet Lamps, Decorative Lamps
 - Street Lamps
- Architecture Lighting, Recess Lights
 - Spot Lights
 - Underwater Lights

PACKAGE HIGHLIGHTS

- 7 Lead Easy-to-use Package (Similar to TO-263)
- Single Exposed Die Attach Pad for Enhancing Thermal Performance
- 10.2 x 13.8 x 4.6 mm Package

⁽¹⁾ EN55015, refer to [Figure 36](#) and [Figure 37](#)

DESCRIPTION

The TPS92550 Constant Current Buck LED Driver Micro-Module drives maximum 450mA LED current up to 10 LEDs in a single string (maximum 14W). It integrates all the power components including the power inductor. The TPS92550 provides a full turn-key, highly efficient solution for wide range of single string LED lighting applications with up to 96% power efficiency. It accepts an input voltage ranging from 4.5V to 36V and delivers a 350mA LED current as default. The LED current is adjustable from 300mA to 450mA by changing a single external resistor.

The module operates at constant switching frequency (400kHz) with low Electro Magnetic Interference (EMI) complying with EN55015 standard. The module has fast control loop to realize fine LED current pulse yielding 256–step PWM dimming resolution at 240Hz for general lighting. Protection feature include thermal shutdown, input under-voltage lockout, LED open-circuit and short-circuit protections. The TPS92550 Micro-Module is available in 7-pin PFM power package.

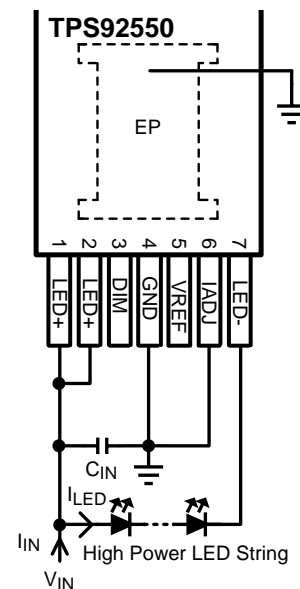
Figure 1. Typical Application Circuit

Please be aware that an important notice concerning availability, standard warranty, and use in critical applications of Texas Instruments semiconductor products and disclaimers thereto appears at the end of this data sheet.

All trademarks are the property of their respective owners.

SYSTEM PERFORMANCE

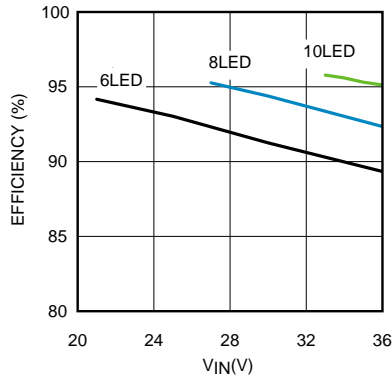

Figure 2. Efficiency vs V_{IN}, I_{LED} = 350mA

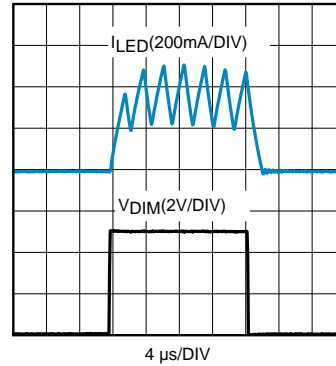

Figure 3. LED Current with PWM Dimming 16μs Dimming Pulse

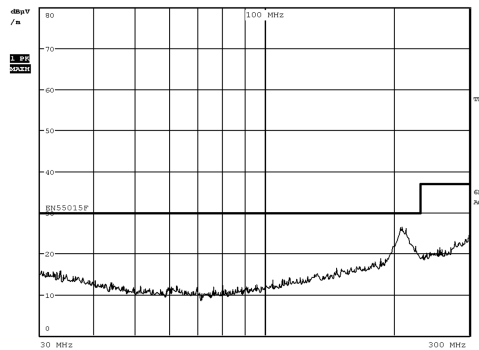
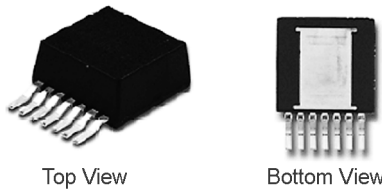

Figure 4. Radiated Emissions (EN 55015)

Easy to Use 7-Pin Package



(1) θ_{JA} measured on a 1.705" x 3.0" four layer board, with one ounce copper, thirty five 12 mil thermal vias, no air flow, and 1W power dissipation.

**Figure 5. 7-Pin PFM Package
10.16 x 13.77 x 4.57 mm (0.4 x 0.39 x 0.18 in)
 $\theta_{JA} = 20^{\circ}\text{C/W}$, $\theta_{JC} = 1.9^{\circ}\text{C/W}^{(1)}$
RoHS Compliant**

CONNECTION DIAGRAM

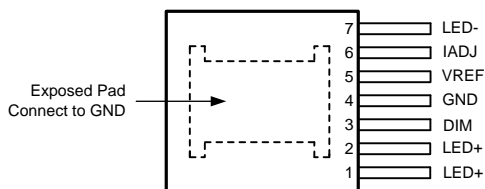

Figure 6. 7-Pin PFM (Top View)
See NDW0007A Package

PIN DESCRIPTIONS

Pin Number	Name	Description	Function
1,2	LED+	Anode of LED string	Supply input and rail connection to the anode of the LED string.
3	DIM	Dimming signal input	Dimming control signal input. Open to enable or apply logic level PWM signal to control the brightness of the LED string.
4	GND	Ground	Reference point for all stated voltages. Connect to the exposed pad of the package externally.
5	VREF	Voltage reference	Internal voltage reference output.
6	IADJ	LED current adjustment	Fine tuning of the LED current by connecting a resistor between this pin and ground. Connect this pin to ground for factory preset current.
7	LED-	Cathode of LED string	The current return pin of the LED string, connect to the cathode of the LED string.
EP	Exposed Pad	Exposed thermal pad	Used to dissipate heat from the package during operation. Must connect to GND directly.



These devices have limited built-in ESD protection. The leads should be shorted together or the device placed in conductive foam during storage or handling to prevent electrostatic damage to the MOS gates.

ABSOLUTE MAXIMUM RATINGS ⁽¹⁾

	VALUE / UNITS
LED+, LED- to GND	-0.3V to 40V
DIM to GND	-0.3V to 6V
IADJ, VREF to GND	-0.3V to 5V
ESD Susceptibility ⁽²⁾	±2 kV (All pins Except Pin 6)
Power Dissipation	Internally Limited
Junction Temperature	150°C
Storage Temperature Range	0°C to 150°C
Peak Reflow Case Temperature (30 sec)	245°C

- (1) Absolute Maximum Ratings are limits beyond which damage to the device may occur. Operating Ratings are conditions under which operation of the device is intended to be functional. For specifications and test conditions, see the Electrical Characteristics.
- (2) The human body model is a 100 pF capacitor discharged through a 1.5 kΩ resistor into each pin. The Pin 6 (IADJ pin) pass ± 1kV. Test method is per JESD22-A114S.

RECOMMENDED OPERATING CONDITIONS ⁽¹⁾

	VALUE / UNITS
LED+, LED-	4.5V to 36V
DIM	0V to 5.5V
IADJ	0V to 0.2V
Junction Temperature (T _J)	-40°C to 125°C

- (1) Absolute Maximum Ratings are limits beyond which damage to the device may occur. Operating Ratings are conditions under which operation of the device is intended to be functional. For specifications and test conditions, see the Electrical Characteristics.

ELECTRICAL CHARACTERISTICS

Limits in standard type are for $T_J = 25^\circ\text{C}$ unless otherwise stated; limits in **boldface** type apply over the operating junction temperature range T_J of -40°C to 125°C . Minimum and maximum limits are specified through test, design, or statistical correlation. Typical values represent the most likely parametric norm at $T_J = 25^\circ\text{C}$, and are provided for reference purposes only. Unless otherwise stated the following conditions apply: $V_{IN} = 24\text{ V}$, $I_{LED} = 350\text{ mA}$. V_{IN} is the voltage applied across LED+ and GND. I_{IN} is the input current flowing into the LED+ node. I_{LED} is a LED current flowing into the LED- pin. V_{LED} is the voltage applied across LED+ and LED-. V_{DIM} is the voltage applied across the DIM pin to ground. Resistor R_{IADJ} connect from IADJ pin to ground. Resistor R_{VREF} connect from VREF pin to ground.

Symbol	Parameter	Conditions	Min ⁽¹⁾	Typ ⁽²⁾	Max ⁽¹⁾	Units
SYSTEM PARAMETERS						
I_{IN}	Input Current	$V_{LED} = 0\text{ V}$, $4.5\text{ V} \leq V_{IN} \leq 36\text{ V}$, $V_{DIM} = 0\text{ V}$	2.0	2.35	2.7	mA
I_{LED}	LED Current	$V_{LED} = 18\text{ V}$, $R_{IADJ} = 0\Omega$, $R_{VREF} = \text{open}$, $T_J = 25^\circ\text{C}$	336	350	361	mA
		$V_{LED} = 18\text{ V}$, $R_{IADJ} = 0\Omega$, $R_{VREF} = \text{open}$, $T_J = 25^\circ\text{C}$ to 125°C	328	350	361	
		$V_{LED} = 18\text{ V}$, $R_{IADJ} = 0\Omega$, $R_{VREF} = \text{open}$, $T_J = -40^\circ\text{C}$ to 125°C	328	350	370	
$I_{LED-36V}$	LED Current at $V_{IN} = 36\text{ V}$	$V_{IN} = 36\text{ V}$, $V_{LED} = 24\text{ V}$, $R_{IADJ} = 0\Omega$, $R_{VREF} = \text{open}$, $T_J = 25^\circ\text{C}$	332	350	359	mA
		$V_{IN} = 36\text{ V}$, $V_{LED} = 24\text{ V}$, $R_{IADJ} = 0\Omega$, $R_{VREF} = \text{open}$, $T_J = 25^\circ\text{C}$ to 125°C	330	350	359	
		$V_{IN} = 36\text{ V}$, $V_{LED} = 24\text{ V}$, $R_{IADJ} = 0\Omega$, $R_{VREF} = \text{open}$, $T_J = -40^\circ\text{C}$ to 125°C	330	350	366	
$I_{LED-ADJ1}$	Adjusted LED Current	$V_{LED} = 18\text{ V}$, $R_{IADJ} = 0\Omega$, $R_{VREF} = 10.5\text{ k}\Omega$, $T_J = 25^\circ\text{C}$	432	450	466	mA
		$V_{LED} = 18\text{ V}$, $R_{IADJ} = 0\Omega$, $R_{VREF} = 10.5\text{ k}\Omega$, $T_J = 25^\circ\text{C}$ to 125°C	429	450	466	
		$V_{LED} = 18\text{ V}$, $R_{IADJ} = 0\Omega$, $R_{VREF} = 10.5\text{ k}\Omega$, $T_J = -40^\circ\text{C}$ to 125°C	429	450	474	
$I_{LED-ADJ2}$	Adjusted LED Current	$V_{LED} = 18\text{ V}$, $R_{IADJ} = 500\Omega$, $R_{VREF} = \text{open}$, $T_J = 25^\circ\text{C}$	287	300	309	mA
		$V_{LED} = 18\text{ V}$, $R_{IADJ} = 500\Omega$, $R_{VREF} = \text{open}$, $T_J = 25^\circ\text{C}$ to 125°C	283	300	309	
		$V_{LED} = 18\text{ V}$, $R_{IADJ} = 500\Omega$, $R_{VREF} = \text{open}$, $T_J = -40^\circ\text{C}$ to 125°C	283	300	315	
$I_{LED-SHORT}$	LED Short Circuit Current at $V_{IN} = 36\text{ V}$	$V_{LED} = 0\text{ V}$, $V_{IN} = 36\text{ V}$, DIM = open	800	900	1020	mA
$I_{LED-LEAK}$	"LED-" pin leakage current	$V_{LED} = 0\text{ V}$, $V_{IN} = \text{operating max}$, DIM = 0V			1.2	μA
f_{SW}	Switching Frequency	$V_{LED} = 12\text{ V}$, $R_{IADJ} = 0\Omega$, $R_{VREF} = \text{open}$	365	400	450	kHz
V_{DIM}	DIM Pin Threshold	V_{DIM} Increasing		1.0	1.2	V
$V_{DIM-HYS}$	DIM Pin Hysteresis			0.25		V
THERMAL CHARACTERISTICS						
T_{SD}	Thermal Shutdown Temperature	T_J Rising		170		$^\circ\text{C}$
T_{SD-HYS}	Thermal Shutdown Temp. Hysteresis	T_J Rising		10		$^\circ\text{C}$
θ_{JA}	Junction to Ambient ⁽³⁾	4 Layer JEDEC Printed Circuit Board, 100 vias, No air flow		19.3		$^\circ\text{C/W}$
		2 Layer JEDEC PCB, No air flow		21.5		
θ_{JC}	Junction to Case	No air flow		1.9		$^\circ\text{C/W}$

- (1) Min and Max limits are 100% production tested at an ambient temperature (T_A) of 25°C . Limits over the operating temperature range are specified through correlation using Statistical Quality Control (SQC) methods. Limits are used to calculate Average Outgoing Quality Level (AOQL).
- (2) Typical numbers are at 25°C and represent the most likely parametric norm.
- (3) θ_{JA} measured on a 1.705" x 3.0" four layer board, with one ounce copper, thirty five 12 mil thermal vias, no air flow, and 1W power dissipation.

TYPICAL PERFORMANCE CHARACTERISTICS

Unless otherwise specified, the following conditions apply: $V_{IN} = 24V$, C_{IN} is a $2.2\mu F$ 100V X7R ceramic capacitor for driving 2–7 power LEDs with $I_{LED} = 350mA$. Single LED forward voltage used is 3.2V. $T_A = 25^\circ C$ for efficiency curves and waveforms.

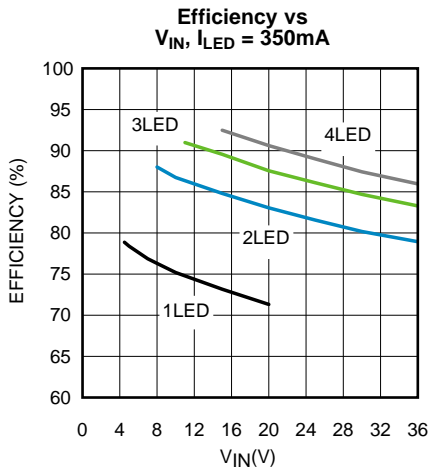

Figure 7.

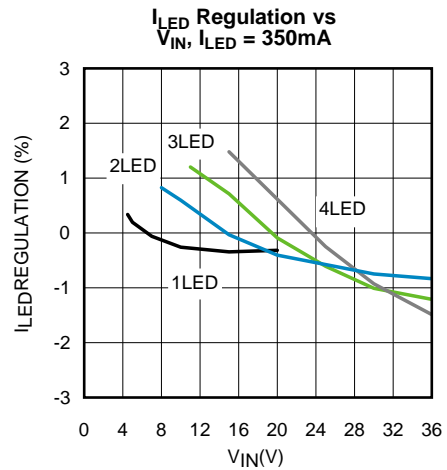

Figure 8.

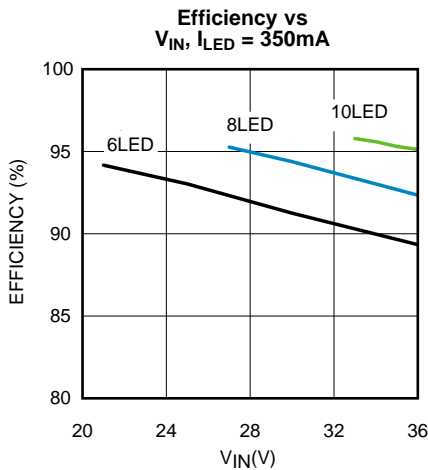

Figure 9.

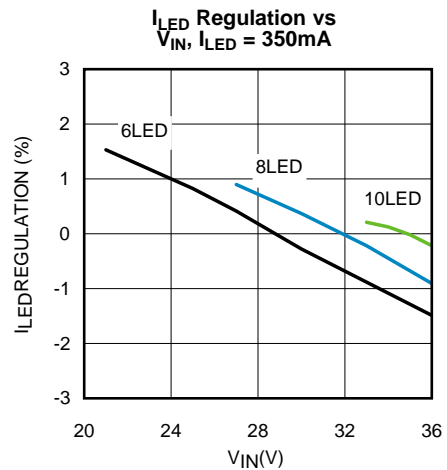

Figure 10.

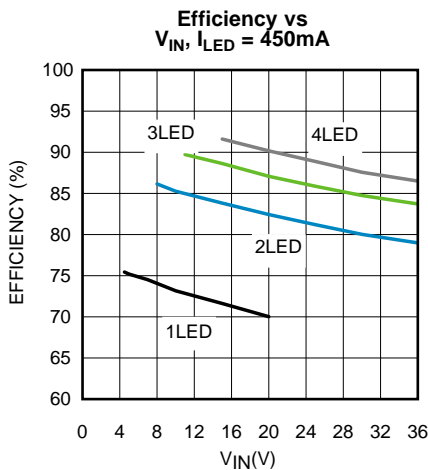

Figure 11.

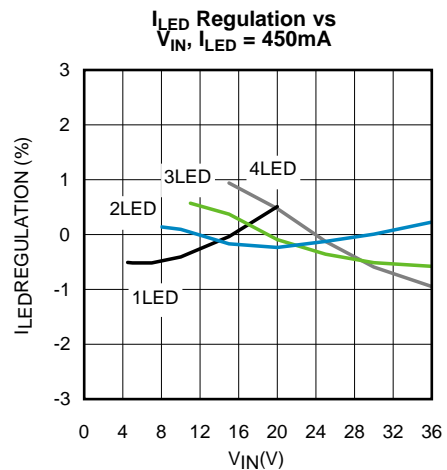

Figure 12.

TYPICAL PERFORMANCE CHARACTERISTICS (continued)

Unless otherwise specified, the following conditions apply: $V_{IN} = 24V$, C_{IN} is a 2.2 μF 100V X7R ceramic capacitor for driving 2–7 power LEDs with $I_{LED} = 350mA$. Single LED forward voltage used is 3.2V. $T_A = 25^\circ C$ for efficiency curves and waveforms.

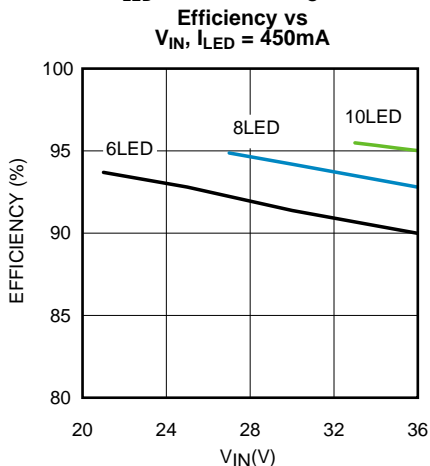

Figure 13.

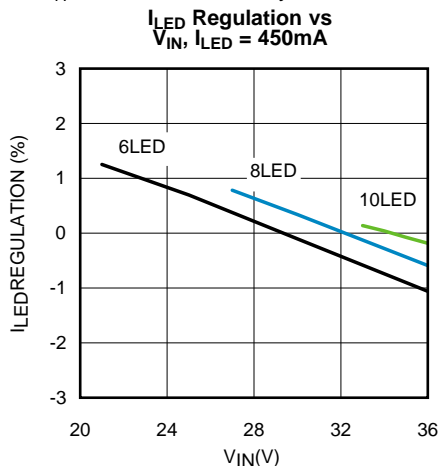

Figure 14.

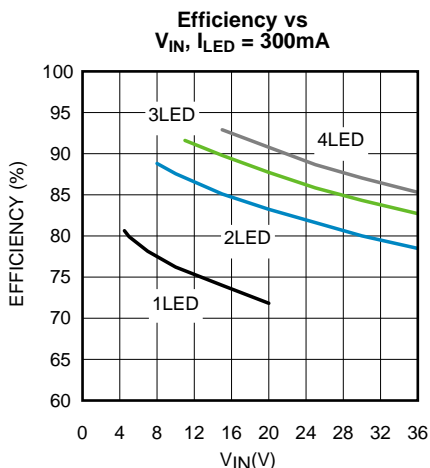

Figure 15.

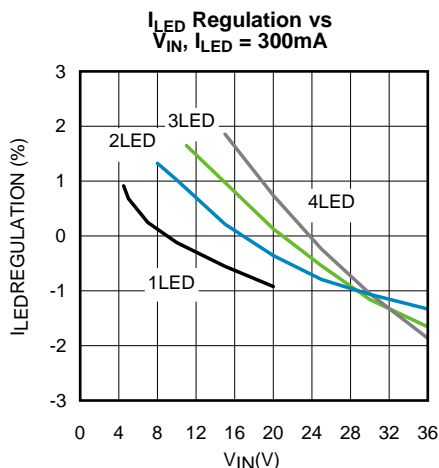

Figure 16.

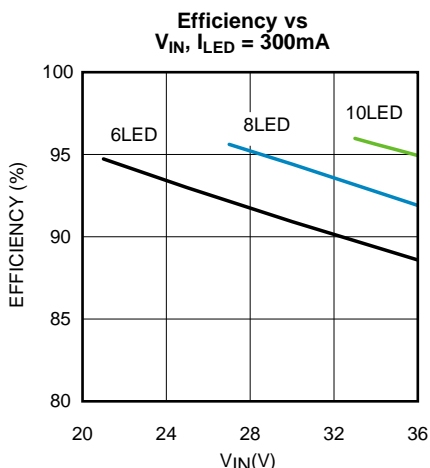

Figure 17.

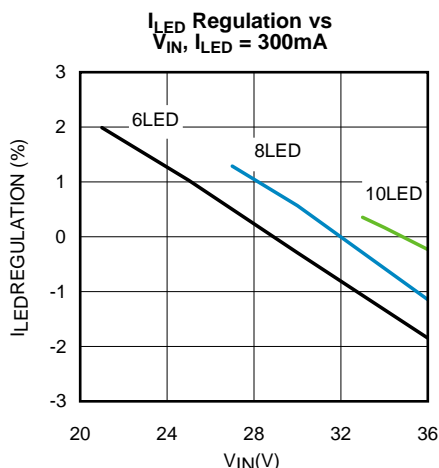

Figure 18.

TYPICAL PERFORMANCE CHARACTERISTICS (continued)

Unless otherwise specified, the following conditions apply: $V_{IN} = 24V$, C_{IN} is a $2.2\mu F$ 100V X7R ceramic capacitor for driving 2–7 power LEDs with $I_{LED} = 350mA$. Single LED forward voltage used is 3.2V. $T_A = 25^\circ C$ for efficiency curves and waveforms.

**LED Current with PWM Dimming
 V_{DIM} Rising**

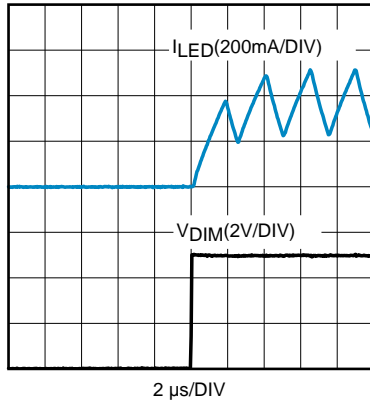

Figure 19.

**LED Current with PWM Dimming
 V_{DIM} Falling**

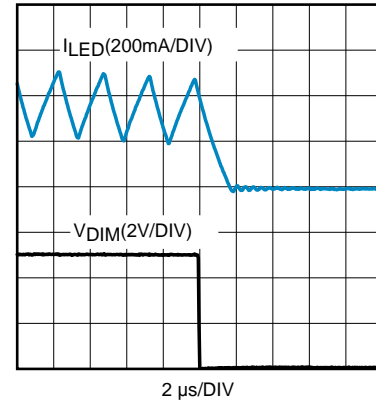

Figure 20.

**LED Current with PWM Dimming
16μs dimming pulse**

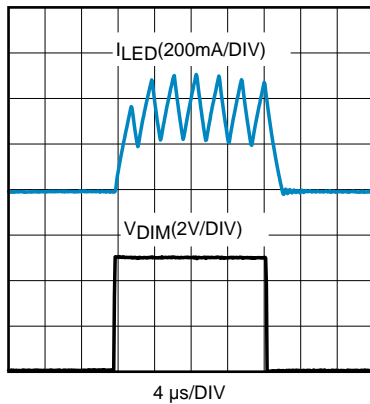

Figure 21.

**I_{IN} vs V_{IN}
 $V_{DIM} = 0V$**

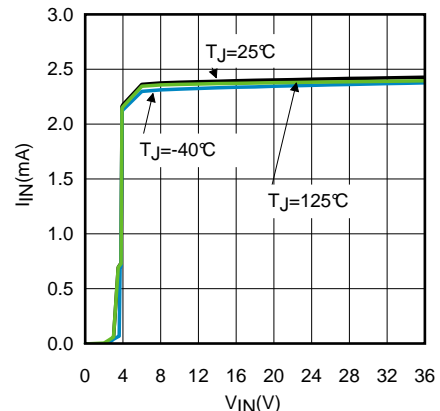

Figure 22.

**I_{IN} vs V_{IN}
LED = open, DIM = open**

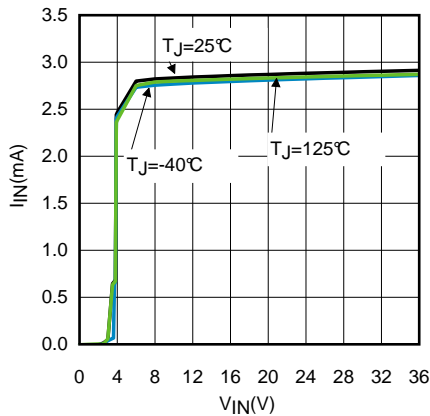

Figure 23.

**I_{LED} vs V_{IN}
3LED**

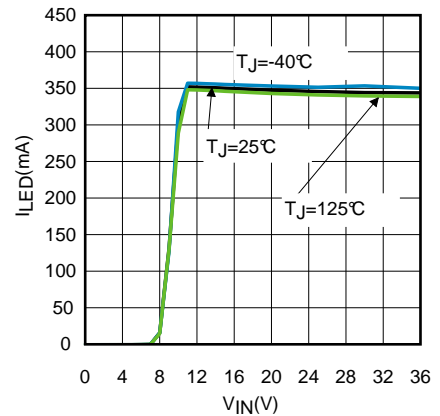

Figure 24.

TYPICAL PERFORMANCE CHARACTERISTICS (continued)

Unless otherwise specified, the following conditions apply: $V_{IN} = 24V$, C_{IN} is a 2.2 μF 100V X7R ceramic capacitor for driving 2–7 power LEDs with $I_{LED} = 350mA$. Single LED forward voltage used is 3.2V. $T_A = 25^\circ C$ for efficiency curves and waveforms.

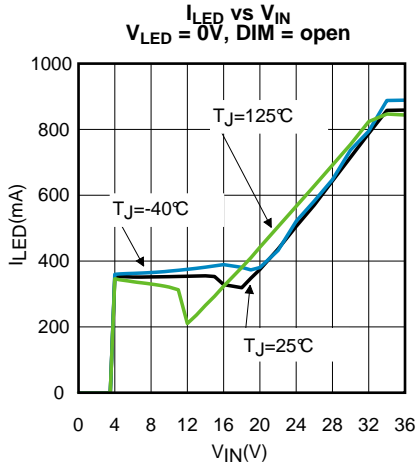

Figure 25.

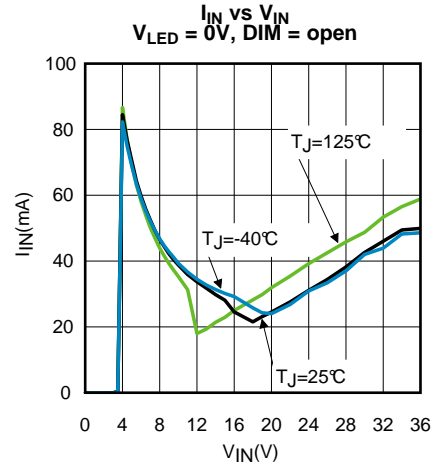

Figure 26.

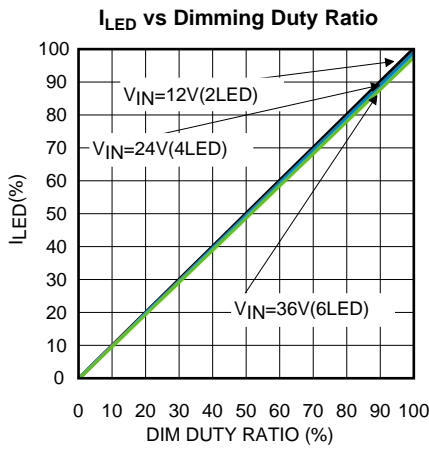

Figure 27.

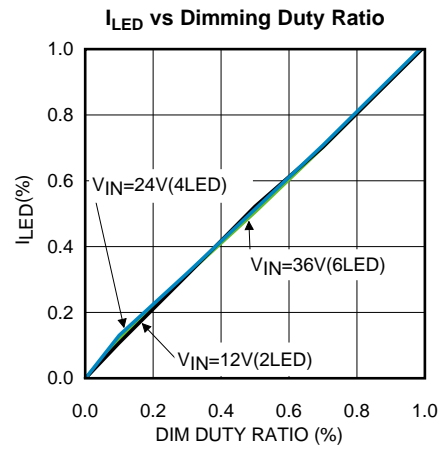

Figure 28.

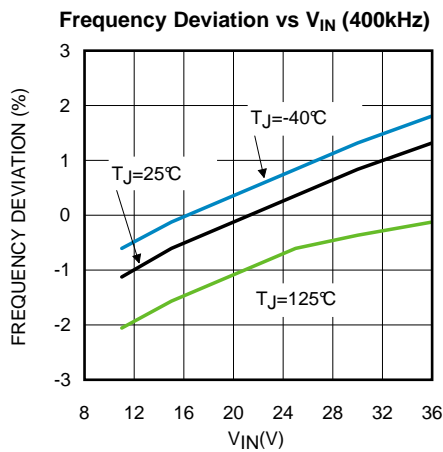

Figure 29.

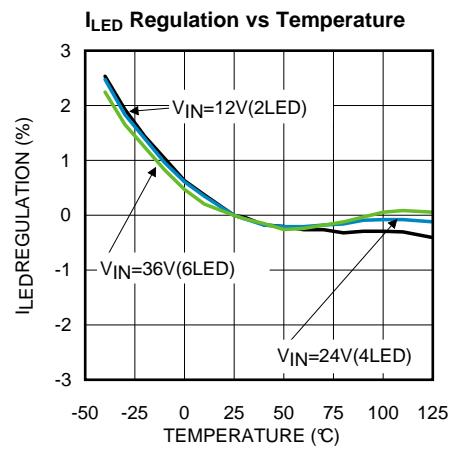

Figure 30.

TYPICAL PERFORMANCE CHARACTERISTICS (continued)

Unless otherwise specified, the following conditions apply: $V_{IN} = 24V$, C_{IN} is a $2.2\mu F$ 100V X7R ceramic capacitor for driving 2–7 power LEDs with $I_{LED} = 350mA$. Single LED forward voltage used is $3.2V$. $T_A = 25^\circ C$ for efficiency curves and waveforms.

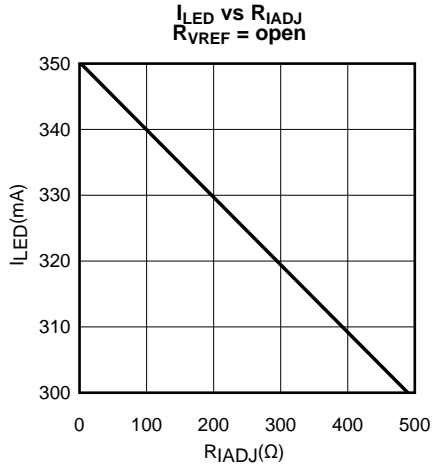

Figure 31.

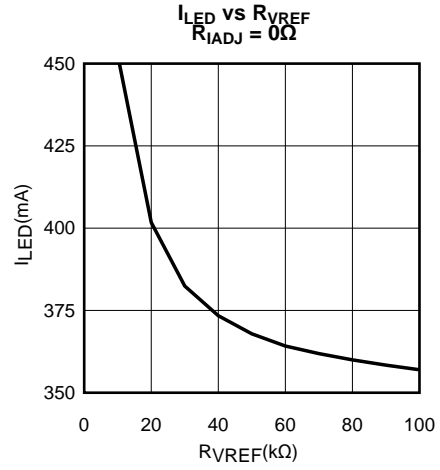
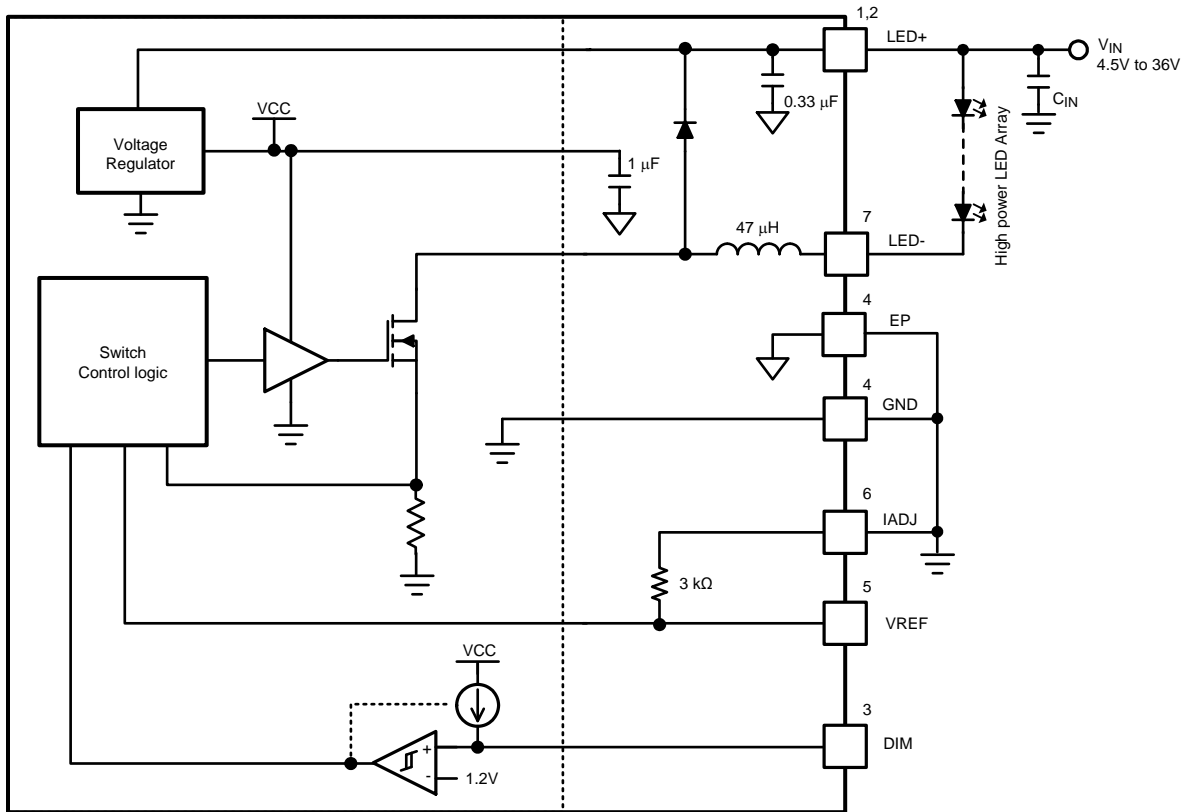

Figure 32.

BLOCK DIAGRAM



Operation Description

The TPS92550 is a high power floating buck LED driver with wide input voltage range. It requires no external current sensing elements and loop compensation network. The integrated power switch enables high output power up to 14W with 450mA LED current.

High speed dimming control input allows precision and high resolution brightness control for applications which require fine brightness adjustment.

APPLICATION INFORMATION

SETTING THE LED CURRENT

The TPS92550 requires no external current sensing resistor for LED current regulation. The average LED current of the TPS92550 is adjustable from 300mA to 450mA by varying the resistance of the resistor according to the following equation and table.

For $R_{VREF} = \text{open}$ and $R_{IADJ} \leq 499\Omega$

$$I_{LED} = \frac{1050}{3k + R_{IADJ}} \tag{1}$$

For $R_{IADJ} = 0$ and $R_{VREF} \geq 10.5k\Omega$

$$I_{LED} = \frac{1050}{3k / R_{VREF}} \tag{2}$$

Table 1. Example for I_{LED} Setting

$R_{IADJ}(\Omega)$	$R_{VREF}(\Omega)$	$I_{LED}(mA)$
499	OPEN	300
SHORT	OPEN	350
SHORT	10.5k	450

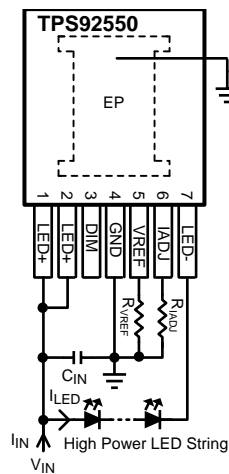

Figure 33. TPS92550 Application Schematic for I_{LED} Setting

Minimum Switch On-Time

The on-time of the internal switch should be no shorter than 400ns. The number of LED (typical forward voltage at 3.2V) to input voltage is constrained by that as shown in the following table.

No. of LED	Max. $V_{IN}(V)$
1	20
2 – 10	36

Peak Switch Current Limit

The TPS92550 features an integrated switch current limiting mechanism to prevent the LEDs from being over-driven. The switch current limiter is triggered when the switch current is three times exceeding the current level set by resistor. Once the current limiter is triggered, the internal power switch turn OFF for 3.6 μ s to discharge the inductor until inductor current reduces back to normal level. The current limiting feature is exceptionally important to avoid permanent damage of the TPS92550 application circuit due to short circuit of LED string.

PWM Dimming Control

The DIM pin of the TPS92550 is an input with internal pull-up that accepts logic signals for average LED current control. Applying a logic high (above 1.2V) signal to the DIM pin or leaving the DIM pin open will enable the device. Applying a logic low signal (below 0.7V) to the DIM pin will disable the switching activity of the device but maintain operation of the VCC regulator active. The TPS92550 operation of high speed dimming and very fine dimming control as shown in Figure 34.

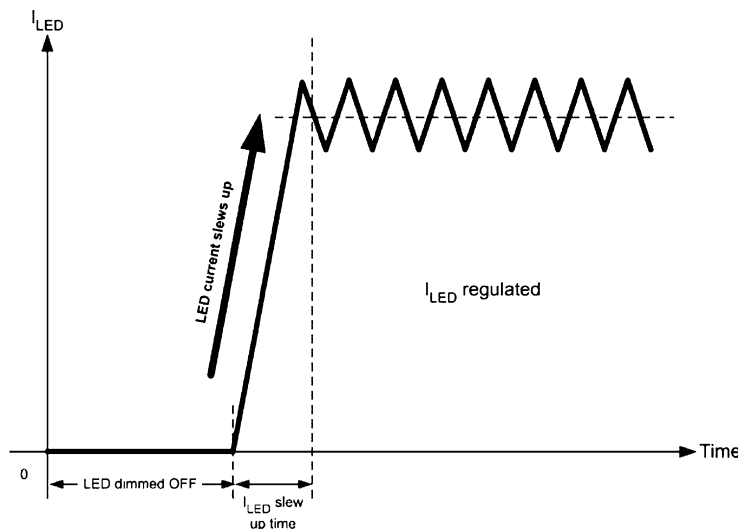

Figure 34. Shortened Current Slew up Time of the TPS92550

To ensure normal operation of the TPS92550, it is recommended to set the dimming frequency not higher than 1/10 of the switching frequency. The dim pulse on time is tested down to 16 μ s. In applications that require high dimming contrast ratio, low dimming frequency should be used.

Parallel Operation

When a load current higher than 450mA is required by the application, TPS92550 can be used in parallel to deliver higher current. With common VINs and GNDs, the TPS92550 will operate as independent asynchronous current sinks driving the same LED load. The total DC current of the modules will be additive; however, low frequency sub-harmonic current ripple may be present and its frequency and magnitude will depend upon the phase relationship between the internal clocks as there is no provision for synchronizing driver clocks. It is suggested to have minimum 2.2 μ F C_{OUT} located close to the module to filter out the current ripple, and the resultant LED current will become DC. Current sharing modules should have a local C_{IN} capacitor of minimum 2.2 μ F located as close to V_{IN} and GND as possible. Refer to Figure 35 for the TPS92550 parallel operation circuit schematic. Refer to Figure 36 for the TPS92550 parallel operation results I_{LED} vs V_{IN}.

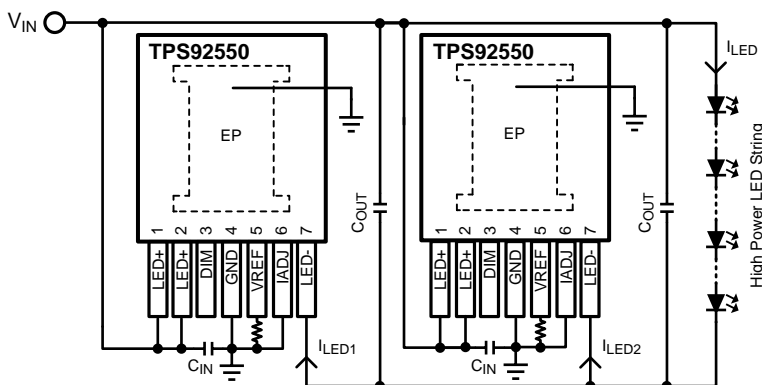

Figure 35. Parallel Operation Circuit Schematic for I_{LED} = 900mA

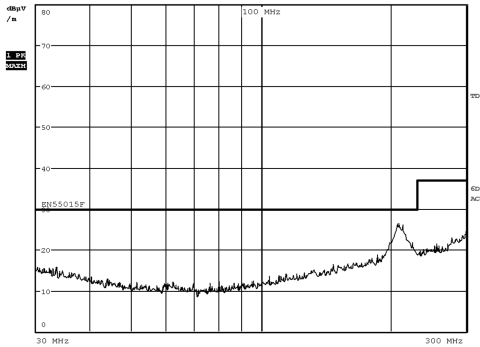

Figure 38. Complies with EN55015 Radiated Emissions (HORI. / HEIGHT=3.0m / RANGE=10m)
 $C_{IN} = 2.2\mu F$, $C_{OUT} = 2.2\mu F$, $V_{IN} = 36V$, $I_{LED} = 350mA$,
 No. of LED = 10

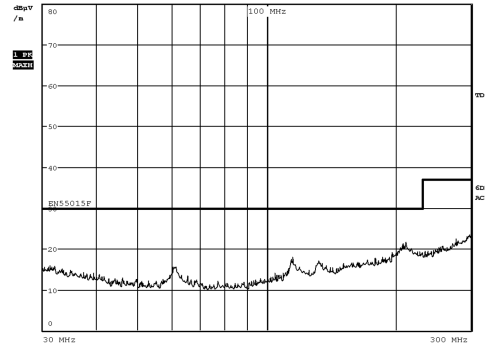

Figure 39. Complies with EN55015 Radiated Emissions (VERT. / HEIGHT=1.0m / RANGE=10m)
 $C_{IN} = 2.2\mu F$, $C_{OUT} = 2.2\mu F$, $V_{IN} = 36V$, $I_{LED} = 350mA$,
 No. of LED = 10

TPS92550 Application Circuit Schematic and BOM

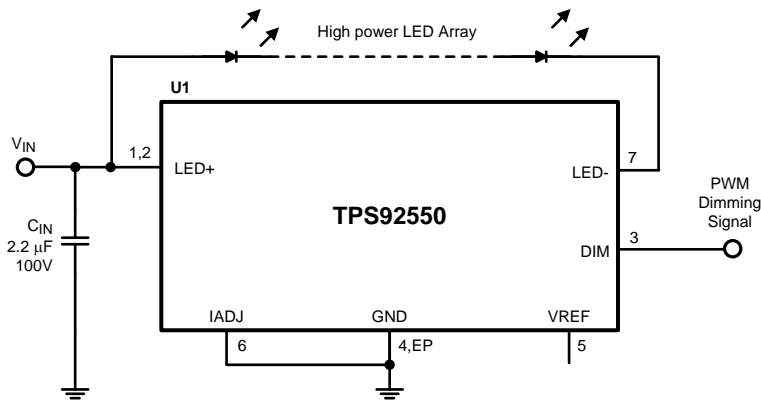

Table 2. Bill of Materials, $V_{IN} = 18V$, $I_{LED} = 350mA$, No. of LED = 2 — 5

Designator	Description	Case Size	Manufacturer	Manufacturer P/N	Quantity
U1	LED Micro-Module Driver	PFM	Texas Instruments	TPS92550TZ	1
C_{IN}	2.2 μF , 100V, X7R	1210	Murata	GRM32ER72A225KA35L	1

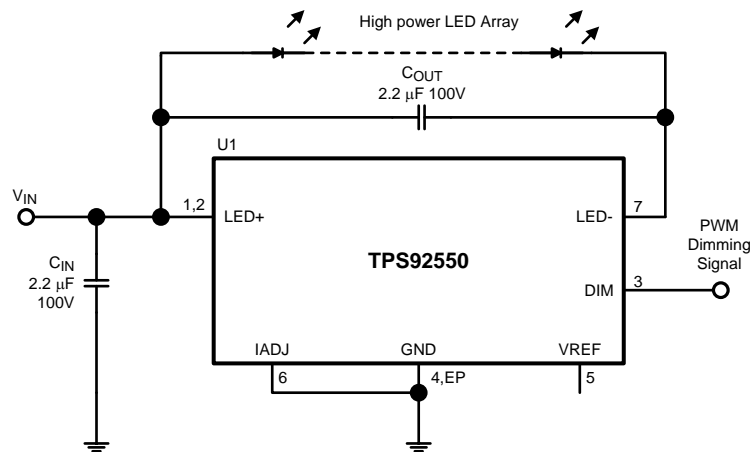

Table 3. Bill of Materials, $V_{IN} = 36V$, $I_{LED} = 350mA$, No. of LED = 10, Complies with EN55015 Radiated

Table 3. Bill of Materials, $V_{IN} = 36V$, $I_{LED} = 350mA$, No.of LED = 10, Complies with EN55015 Radiated Emissions (continued)

Emissions

Designator	Description	Case Size	Manufacturer	Manufacturer P/N	Quantity
U1	LED Micro-Module Driver	PFM	Texas Instruments	TPS92550TZ	1
C _{IN}	2.2 μ F, 100V, X7R	1210	Murata	GRM32ER72A225KA35L	1
C _{OUT}	2.2 μ F, 100V, X7R	1210	Murata	GRM32ER72A225KA35L	1

PCB Layout Diagrams

The PCB design is available in the TPS92550 product folder at www.ti.com.

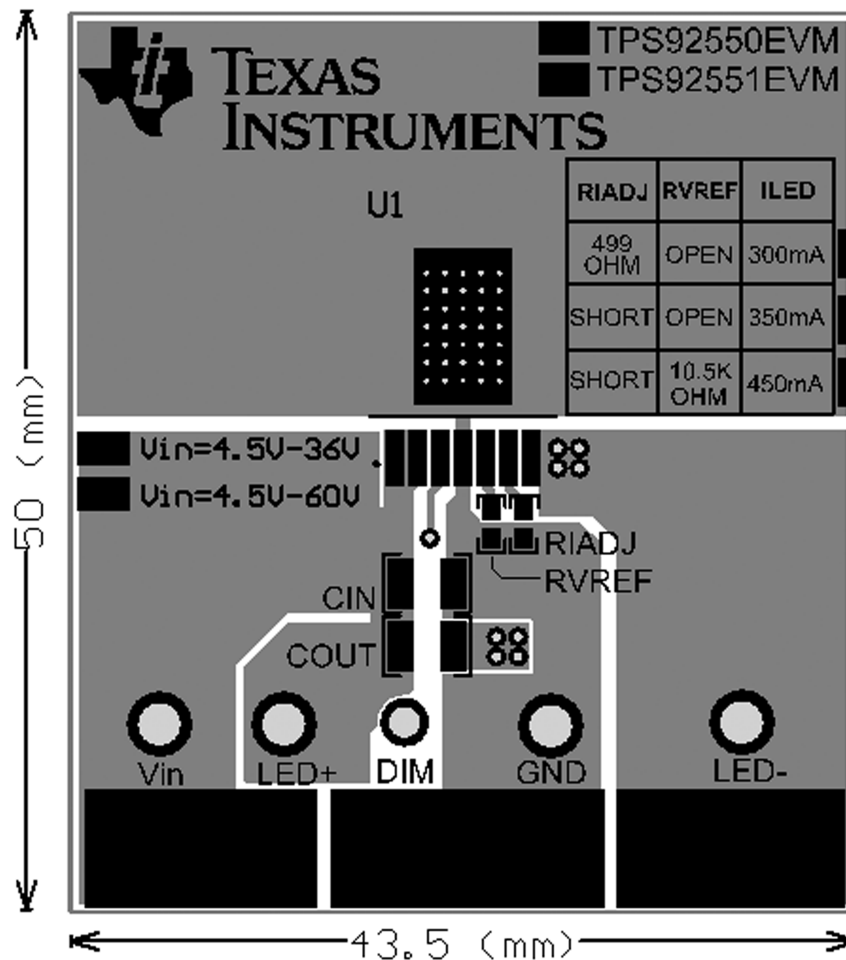

Figure 40. Top Layer and Top Overlay

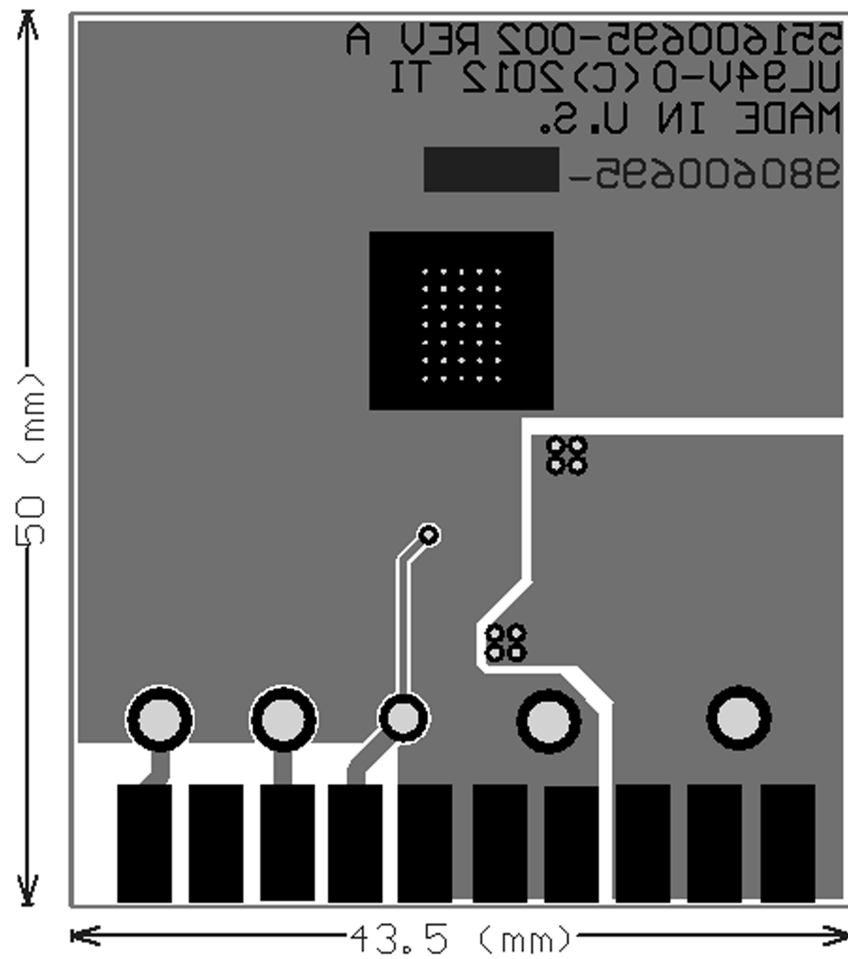

Figure 41. Bottom Layer and Bottom Overlay

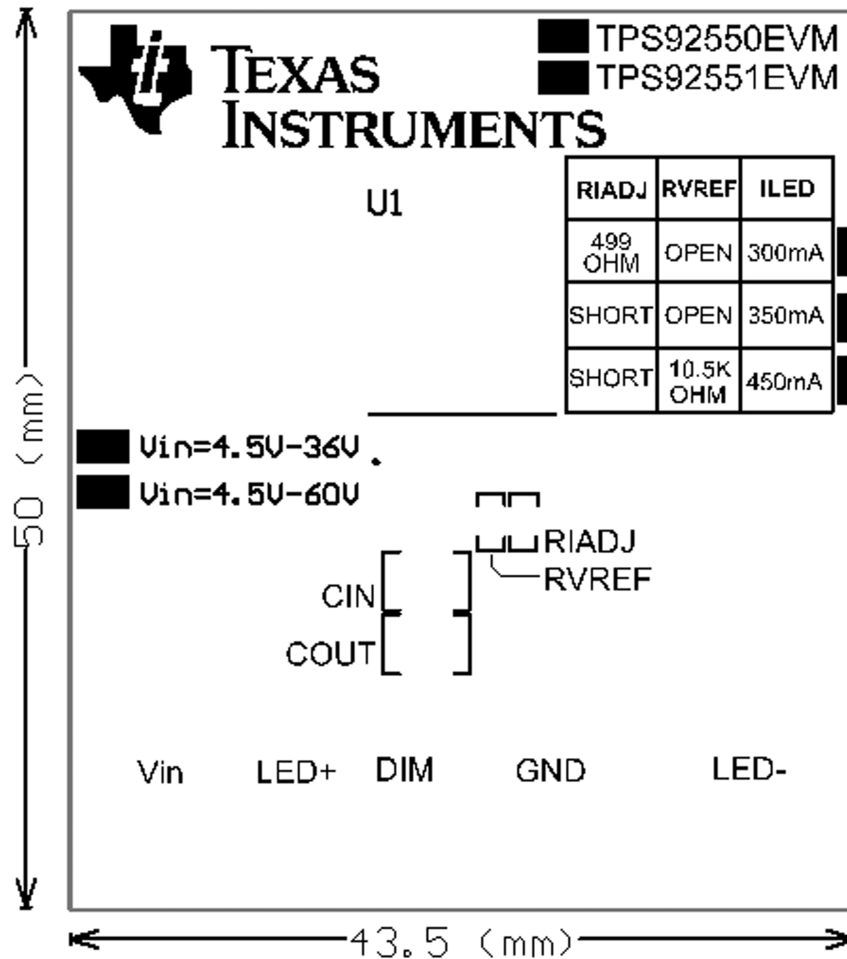



Figure 42. Top Overlay

REVISION HISTORY

Changes from Revision B (May 2013) to Revision C	Page
• Changed layout of National Data Sheet to TI format	18

PACKAGING INFORMATION

Orderable Device	Status (1)	Package Type	Package Drawing	Pins	Package Qty	Eco Plan (2)	Lead finish/ Ball material (6)	MSL Peak Temp (3)	Op Temp (°C)	Device Marking (4/5)	Samples
TPS92550TZ/NOPB	ACTIVE	TO-PMOD	NDW	7	250	RoHS Exempt & Green	SN	Level-3-245C-168 HR	-40 to 125	TPS92550 TZ	
TPS92550TZX/NOPB	ACTIVE	TO-PMOD	NDW	7	500	RoHS Exempt & Green	SN	Level-3-245C-168 HR	-40 to 125	TPS92550 TZ	

(1) The marketing status values are defined as follows:

ACTIVE: Product device recommended for new designs.

LIFEBUY: TI has announced that the device will be discontinued, and a lifetime-buy period is in effect.

NRND: Not recommended for new designs. Device is in production to support existing customers, but TI does not recommend using this part in a new design.

PREVIEW: Device has been announced but is not in production. Samples may or may not be available.

OBsolete: TI has discontinued the production of the device.

(2) **RoHS:** TI defines "RoHS" to mean semiconductor products that are compliant with the current EU RoHS requirements for all 10 RoHS substances, including the requirement that RoHS substance do not exceed 0.1% by weight in homogeneous materials. Where designed to be soldered at high temperatures, "RoHS" products are suitable for use in specified lead-free processes. TI may reference these types of products as "Pb-Free".

RoHS Exempt: TI defines "RoHS Exempt" to mean products that contain lead but are compliant with EU RoHS pursuant to a specific EU RoHS exemption.

Green: TI defines "Green" to mean the content of Chlorine (Cl) and Bromine (Br) based flame retardants meet JS709B low halogen requirements of <=1000ppm threshold. Antimony trioxide based flame retardants must also meet the <=1000ppm threshold requirement.

(3) MSL, Peak Temp. - The Moisture Sensitivity Level rating according to the JEDEC industry standard classifications, and peak solder temperature.

(4) There may be additional marking, which relates to the logo, the lot trace code information, or the environmental category on the device.

(5) Multiple Device Markings will be inside parentheses. Only one Device Marking contained in parentheses and separated by a "~" will appear on a device. If a line is indented then it is a continuation of the previous line and the two combined represent the entire Device Marking for that device.

(6) Lead finish/Ball material - Orderable Devices may have multiple material finish options. Finish options are separated by a vertical ruled line. Lead finish/Ball material values may wrap to two lines if the finish value exceeds the maximum column width.

Important Information and Disclaimer:The information provided on this page represents TI's knowledge and belief as of the date that it is provided. TI bases its knowledge and belief on information provided by third parties, and makes no representation or warranty as to the accuracy of such information. Efforts are underway to better integrate information from third parties. TI has taken and continues to take reasonable steps to provide representative and accurate information but may not have conducted destructive testing or chemical analysis on incoming materials and chemicals. TI and TI suppliers consider certain information to be proprietary, and thus CAS numbers and other limited information may not be available for release.

In no event shall TI's liability arising out of such information exceed the total purchase price of the TI part(s) at issue in this document sold by TI to Customer on an annual basis.

TAPE AND REEL INFORMATION

QUADRANT ASSIGNMENTS FOR PIN 1 ORIENTATION IN TAPE

*All dimensions are nominal

Device	Package Type	Package Drawing	Pins	SPQ	Reel Diameter (mm)	Reel Width W1 (mm)	A0 (mm)	B0 (mm)	K0 (mm)	P1 (mm)	W (mm)	Pin1 Quadrant
TPS92550TZ/NOPB	TO-PMOD	NDW	7	250	330.0	24.4	10.6	14.22	5.0	16.0	24.0	Q2
TPS92550TZ/NOPB	TO-PMOD	NDW	7	500	330.0	24.4	10.6	14.22	5.0	16.0	24.0	Q2

TAPE AND REEL BOX DIMENSIONS

*All dimensions are nominal

Device	Package Type	Package Drawing	Pins	SPQ	Length (mm)	Width (mm)	Height (mm)
TPS92550TZ/NOPB	TO-PMOD	NDW	7	250	367.0	367.0	45.0
TPS92550TZ/NOPB	TO-PMOD	NDW	7	500	367.0	367.0	45.0

NDW0007A

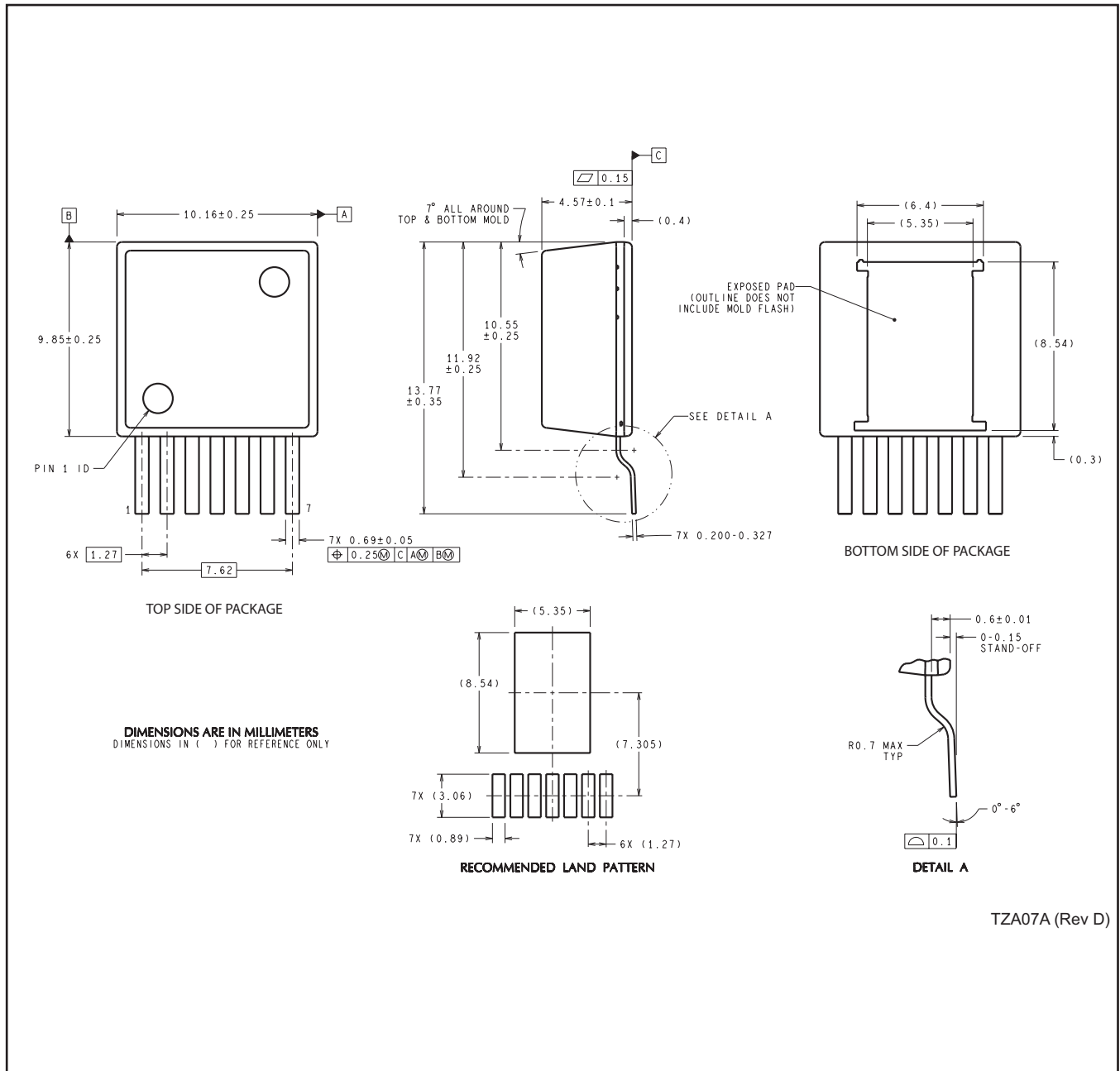

IMPORTANT NOTICE AND DISCLAIMER

TI PROVIDES TECHNICAL AND RELIABILITY DATA (INCLUDING DATA SHEETS), DESIGN RESOURCES (INCLUDING REFERENCE DESIGNS), APPLICATION OR OTHER DESIGN ADVICE, WEB TOOLS, SAFETY INFORMATION, AND OTHER RESOURCES "AS IS" AND WITH ALL FAULTS, AND DISCLAIMS ALL WARRANTIES, EXPRESS AND IMPLIED, INCLUDING WITHOUT LIMITATION ANY IMPLIED WARRANTIES OF MERCHANTABILITY, FITNESS FOR A PARTICULAR PURPOSE OR NON-INFRINGEMENT OF THIRD PARTY INTELLECTUAL PROPERTY RIGHTS.

These resources are intended for skilled developers designing with TI products. You are solely responsible for (1) selecting the appropriate TI products for your application, (2) designing, validating and testing your application, and (3) ensuring your application meets applicable standards, and any other safety, security, regulatory or other requirements.

These resources are subject to change without notice. TI grants you permission to use these resources only for development of an application that uses the TI products described in the resource. Other reproduction and display of these resources is prohibited. No license is granted to any other TI intellectual property right or to any third party intellectual property right. TI disclaims responsibility for, and you will fully indemnify TI and its representatives against, any claims, damages, costs, losses, and liabilities arising out of your use of these resources.

TI's products are provided subject to [TI's Terms of Sale](#) or other applicable terms available either on ti.com or provided in conjunction with such TI products. TI's provision of these resources does not expand or otherwise alter TI's applicable warranties or warranty disclaimers for TI products.

TI objects to and rejects any additional or different terms you may have proposed.

Mailing Address: Texas Instruments, Post Office Box 655303, Dallas, Texas 75265
Copyright © 2022, Texas Instruments Incorporated