

UCC2800/2801/2802/2803/2804/2805-EP LOW-POWER BICMOS CURRENT-MODE PWM

SGLS135F – SEPTEMBER 2002 – REVISED OCTOBER 2010

- **Controlled Baseline**
 - One Assembly
 - One Test Site
 - One Fabrication Site
- **Extended Temperature Performance of –55°C to 125°C**
- **Enhanced Diminishing Manufacturing Sources (DMS) Support**
- **Enhanced Product Change Notification**
- **Qualification Pedigree†**
- **ESD Protection Exceeds 200 V Using Machine Model (C = 200 pF, R = 0)**
- **100 μ A Typical Starting Supply Current**
- **500 μ A Typical Operating Supply Current**
- **Operation to 1 MHz**
- **Internal Soft Start**
- **Internal Fault Soft Start**
- **Internal Leading-Edge Blanking of the Current Sense Signal**
- **1 Amp Totem-Pole Output**
- **70 ns Typical Response from Current-Sense to Gate Drive Output**
- **1.5% Tolerance Voltage Reference**
- **Same Pinout as UC3842 and UC3842A**

† Component qualification in accordance with JEDEC and industry standards to ensure reliable operation over an extended temperature range. This includes, but is not limited to, Highly Accelerated Stress Test (HAST) or biased 85/85, temperature cycle, autoclave or unbiased HAST, electromigration, bond intermetallic life, and mold compound life. Such qualification testing should not be viewed as justifying use of this component beyond specified performance and environmental limits.

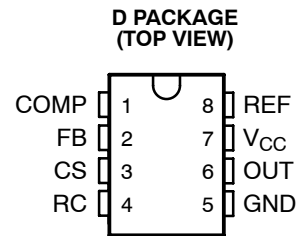

description

The UCC2800/1/2/3/4/5 family of high-speed, low-power integrated circuits contain all of the control and drive components required for off-line and dc-to-dc fixed frequency current-mode switching power supplies with minimal parts count.

These devices have the same pin configuration as the UC2842/3/4/5 family and also offer the added features of internal full-cycle soft start and internal leading-edge blanking of the current-sense input.

The UCC2800/1/2/3/4/5 family offers choice of maximum duty cycle and critical voltage levels. Lower reference parts such as the UCC2803 and UCC2805 fit best into battery operated systems, while the higher reference and the higher UVLO hysteresis of the UCC2802 and UCC2804 make these ideal choices for use in off-line power supplies.

PART NUMBER	MAXIMUM DUTY CYCLE	REFERENCE VOLTAGE	TURN-ON THRESHOLD	TURN-OFF THRESHOLD
UCC2800	100%	5 V	7.2 V	6.9 V
UCC2801	50%	5 V	9.4 V	7.4 V
UCC2802	100%	5 V	12.5 V	8.3 V
UCC2803	100%	4 V	4.1 V	3.6 V
UCC2804	50%	5 V	12.5 V	8.3 V
UCC2805	50%	4 V	4.1 V	3.6 V



Please be aware that an important notice concerning availability, standard warranty, and use in critical applications of Texas Instruments semiconductor products and disclaimers thereto appears at the end of this data sheet.

PRODUCTION DATA information is current as of publication date. Products conform to specifications per the terms of Texas Instruments standard warranty. Production processing does not necessarily include testing of all parameters.

 **TEXAS
INSTRUMENTS**

POST OFFICE BOX 655303 • DALLAS, TEXAS 75265

Copyright © 2007, Texas Instruments Incorporated

UCC2800/2801/2802/2803/2804/2805-EP LOW-POWER BICMOS CURRENT-MODE PWM

SGLS135F – SEPTEMBER 2002 – REVISED OCTOBER 2010

ORDERING INFORMATION†

T _A	PACKAGE‡		ORDERABLE PART NUMBER	TOP-SIDE MARKING
-40°C to 125°C	SOP – D	Tape and reel	UCC2800QDREP	2800EP
			UCC2801QDREP	2801EP
			UCC2802QDREP	2802EP
			UCC2803QDREP	2803EP
			UCC2804QDREP	2804EP
			UCC2805QDREP	2805EP
-55°C to 125°C	SOP – D	Tape and reel	UCC2800MDREP	2800EP
			UCC2801MDREP	2801EP
			UCC2803MDREP	2803EP

† For the most current package and ordering information, see the Package Option Addendum at the end of this document, or see the TI website at www.ti.com.

‡ Package drawings, thermal data, and symbolization are available at www.ti.com/packaging.

block diagram

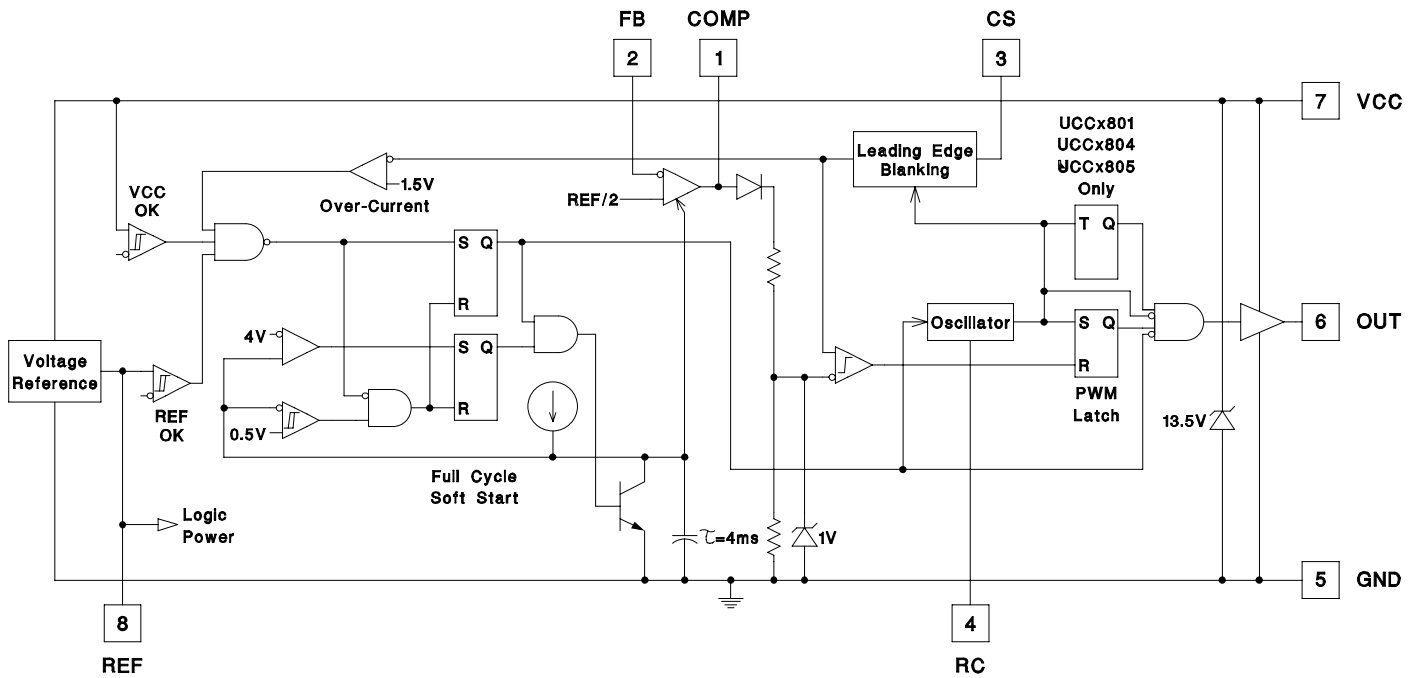

UCC2800/2801/2802/2803/2804/2805-EP LOW-POWER BICMOS CURRENT-MODE PWM

SGLS135F – SEPTEMBER 2002 – REVISED OCTOBER 2010

Ordering Information

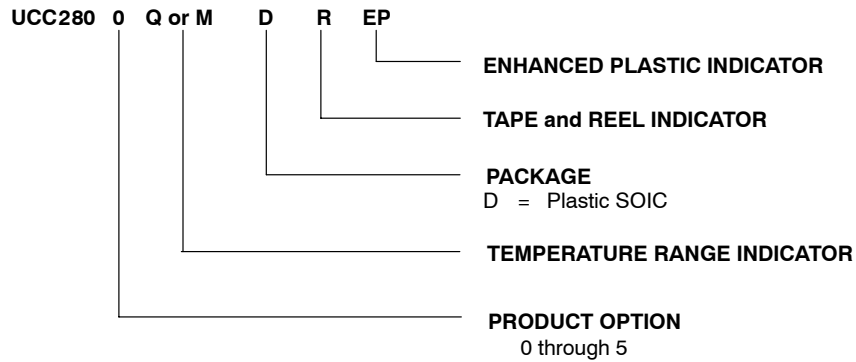

UCC280XXD-EP Operating Life Derating Chart

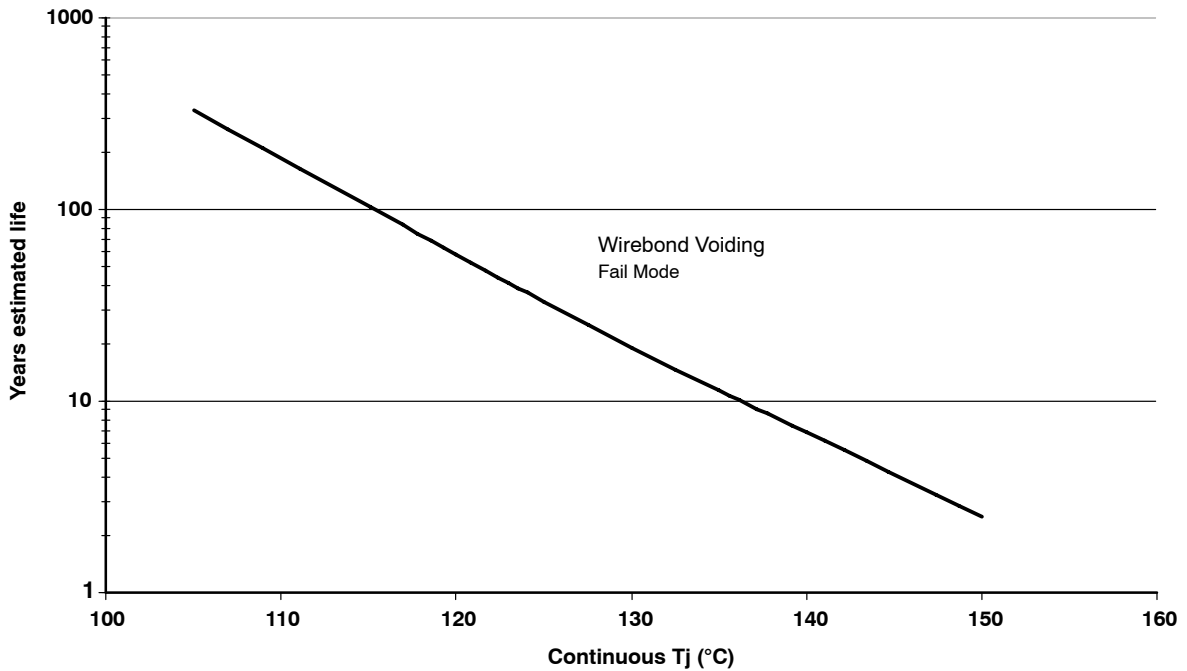

- NOTES: A. See datasheet for Absolute Maximum and Minimum Recommended Operating Conditions
 B. Silicon operating life design Goal is 10 @ 105°C junction temperature (does not include package interconnect life).
 C. Enhanced plastic product disclaimer applies.

UCC2800/2801/2802/2803/2804/2805-EP

LOW-POWER BICMOS CURRENT-MODE PWM

SGLS135F – SEPTEMBER 2002 – REVISED OCTOBER 2010

absolute maximum ratings over operating free-air temperature range (unless otherwise noted)^{†‡}

V_{CC} voltage §	12 V
V_{CC} current §	30 mA
Output current, I_O	±1 A
Output energy (capacitive load)	20 μ J
Analog inputs (FB, CS, RC, COMP)	-0.3 V to the lesser of 6.3 V or $V_{CC} + 0.3$ V
Power dissipation at $T_A < +25^\circ\text{C}$ (D package)	0.65 W
Storage temperature range, T_{stg}	-65°C to 150°C
Lead temperature soldering 1,6 mm (1/16 in) from case for 10s	300°C

[†] Stresses beyond those listed under “absolute maximum ratings” may cause permanent damage to the device. These are stress ratings only, and functional operation of the device at these or any other conditions beyond those indicated under “recommended operating conditions” is not implied. Exposure to absolute-maximum-rated conditions for extended periods may affect device reliability.

[‡] Unless otherwise indicated, voltages are reference to ground and currents are positive into and negative out of the specified terminals.

§ In normal operation, V_{CC} is powered through a current limiting resistor. Absolute maximum of 12 V applies when V_{CC} is driven from a low impedance source such that I_{CC} does not exceed 30 mA (which includes gate drive current requirement).

electrical characteristics, $T_A = -40^\circ\text{C}$ to 125°C for Q temp and $T_A = -55^\circ\text{C}$ to 125°C for M temp, $V_{CC} = 10$ V (see Note 1), $R_T = 100$ k Ω from REF to RC, $C_T = 330$ pF from RC to GND, 0.1 F capacitor from V_{CC} to GND, 0.1 F capacitor from V_{REF} to GND and $T_A = T_J$ (unless otherwise stated)

PARAMETER	TEST CONDITIONS	UCC280XQ, UCC280XM			UNIT	
		MIN	TYP	MAX		
Reference Section						
Output voltage	$T_J = 25^\circ\text{C}$, $I = 0.2$ mA	UCC2800/01/02/04	4.925	5	5.075	V
		UCC2803/05	3.94	4	4.06	
Load regulation voltage	$I = 0.2$ mA to 5 mA		10	30	mV	
Line regulation voltage	$V_{CC} = 10$ V to clamp	$T_J = 25^\circ\text{C}$			1.9	mV/V
		$T_J = -40^\circ\text{C}$ to 125°C and $T_J = -55^\circ\text{C}$ to 125°C			2.5	
Total variation voltage	See Note 5	UCC2800/01/02/04	4.88	5	5.1	V
		UCC2803/05	3.9	4	4.08	
Output noise voltage	$f = 10$ Hz to 10 kHz, See Note 7	$T_J = 25^\circ\text{C}$		130	μ V	
Long term stability	1000 hours, See Note 7	$T_A = 125^\circ\text{C}$		5	mV	
Output short-circuit current			-5		-35	mA



UCC2800/2801/2802/2803/2804/2805-EP LOW-POWER BICMOS CURRENT-MODE PWM

SGLS135F – SEPTEMBER 2002 – REVISED OCTOBER 2010

electrical characteristics, $T_A = -40^\circ\text{C}$ to 125°C for Q temp and $T_A = -55^\circ\text{C}$ to 125°C for M temp, $V_{CC} = 10\text{ V}$ (see Note 1), $R_T = 100\text{ k}\Omega$ from REF to RC, $C_T = 330\text{ pF}$ from RC to GND, 0.1 F capacitor from V_{CC} to GND, 0.1 F capacitor from V_{REF} to GND and $T_A = T_J$ (unless otherwise stated)

PARAMETER	TEST CONDITIONS		UCC280XQ, UCC280XM			UNIT
			MIN	TYP	MAX	
Oscillator Section						
Oscillator frequency	See Note 2	UCC2800/01/02/04	40	46	52	kHz
		UCC2803/05	26	31	36	
Temperature stability	See Note 7		2.5%			
Amplitude peak-to-peak			2.25	2.4	2.55	V
Oscillator peak voltage			2.45			V
Error Amplifier Section						
Input voltage	COMP = 2.5 V	UCC2800/01/02/04	2.44	2.5	2.56	V
	COMP = 2 V	UCC2803/05	1.95	2	2.05	
Input bias current			-1		1	μA
Open loop voltage gain			60	80		db
COMP sink current	FB = 2.7 V, COMP = 1.1 V		0.3		3.5	mA
COMP source current	FB = 1.8 V, COMP = REF - 1.2 V		-0.2	-0.5	-0.8	mA
Gain bandwidth product	See Note 7		2			MHz
PWM Section						
Maximum duty cycle		UCC2800/02/03	97%	99%	100%	
		UCC2801/04/05	48%	49%	50%	
Minimum duty cycle	COMP = 0 V		0			
Current Sense Section						
Gain	See Note 3		1.1	1.65	1.8	V/V
Maximum input signal	COMP = 5 V, See Note 4		0.9	1	1.1	V
Input bias current			-200		200	nA
CS blank time			50	100	150	ns
Overcurrent threshold voltage			1.42	1.55	1.68	V
COMP to CS offset voltage	CS = 0 V		0.45	0.9	1.35	V
Output Section (OUT)						
Low-level output voltage	$I_{OUT} = 20\text{ mA}$	All parts	0.1 0.4			V
	$I_{OUT} = 200\text{ mA}$	All parts	0.35 0.9			
	$I_{OUT} = 50\text{ mA}, V_{CC} = 5\text{ V}$	UCC2803/05	0.15 0.4			
	$I_{OUT} = 20\text{ mA}, V_{CC} = 0\text{ V}$	All parts	0.7 1.2			
High-level output voltage $V_{SAT} (V_{CC} - OUT)$	$I_{OUT} = -20\text{ mA}$	All parts	0.15 0.4			V
	$I_{OUT} = -200\text{ mA}$	All parts	1 1.9			
	$I_{OUT} = -50\text{ mA}, V_{CC} = 5\text{ V}$	UCC2803/05	0.4 0.9			
Rise time	$C_L = 1\text{ nF}$		41 70			ns
Fall time	$C_L = 1\text{ nF}$		44 75			ns



UCC2800/2801/2802/2803/2804/2805-EP

LOW-POWER BICMOS CURRENT-MODE PWM

SGLS135F – SEPTEMBER 2002 – REVISED OCTOBER 2010

electrical characteristics, $T_A = -40^\circ\text{C}$ to 125°C for Q temp and $T_A = -55^\circ\text{C}$ to 125°C for M temp, $V_{CC} = 10\text{ V}$ (see Note 1), $R_T = 100\text{ k}\Omega$ from REF to RC, $C_T = 330\text{ pF}$ from RC to GND, 0.1 F capacitor from V_{CC} to GND, 0.1 F capacitor from V_{REF} to GND and $T_A = T_J$ (unless otherwise stated)

PARAMETER	TEST CONDITIONS	UCC280XQ, UCC280XM			UNIT	
		MIN	TYP	MAX		
Undervoltage Lockout Section						
Start threshold	See Note 6	UCC2800	6.6	7.2	7.8	V
		UCC2801	8.6	9.4	10.2	
		UCC2802/04	11.5	12.5	13.5	
		UCC2803/05	3.7	4.1	4.5	
Stop threshold	See Note 6	UCC2800	6.3	6.9	7.5	V
		UCC2801	6.8	7.4	8	
		UCC2802/04	7.6	8.3	9	
		UCC2803/05	3.2	3.6	4	
Start to stop hysteresis		UCC2800	0.12	0.3	0.48	V
		UCC2801	1.6	2	2.4	
		UCC2802/04	3.5	4.2	5.1	
		UCC2803/05	0.2	0.5	0.8	
Soft Start Section						
COMP rise time	FB = 1.8 V, Rise from 0.5 V to REF – 1 V		4	10	ms	
Overall Section						
Start-up current	$V_{CC} < \text{Start threshold}$		0.1	0.2	mA	
Operating supply current	FB = 0 V, CS = 0 V		0.5	1	mA	
V_{CC} internal zener voltage	$I_{CC} = 10\text{ mA}$, See Note 6 and Note 8		12	13.5	15	V
V_{CC} internal zener voltage minus start threshold voltage	See Note 6	UCC2802/04	0.5	1	V	

- NOTES: 1. Adjust V_{CC} above the start threshold before setting at 10 V.
 2. Oscillator frequency for the UCC2800, UCC2802, and UCC2803 is the output frequency.
 Oscillator frequency for the UCC2801, UCC2804, and UCC2805 is twice the output frequency.

$$A = \frac{\Delta V_{COMP}}{\Delta V_{CS}}$$

3. Gain is defined by: $0 \leq V_{CS} \leq 0.8\text{ V}$
 4. Parameter measured at trip point of latch with Pin 2 at 0 V
 5. Total variation includes temperature stability and load regulation.
 6. Start threshold, stop threshold, and zener shunt thresholds track one another.
 7. Not production tested
 8. The device is fully operating in clamp mode as the forcing current is higher than the normal operating supply current.



detailed terminal descriptions

COMP

COMP is the output of the error amplifier and the input of the PWM comparator.

Unlike other devices, the error amplifier in the UCC2800 family is a true, low output-impedance, 2 MHz operational amplifier. As such, the COMP terminal can both source and sink current. However, the error amplifier is internally current limited, so that one can command zero duty cycle by externally forcing COMP to GND.

The UCC2800 family features built-in full cycle soft start. Soft start is implemented as a clamp on the maximum COMP voltage.

CS

CS is the input to the current sense comparators. The UCC2800 family has two different current sense comparators - the PWM comparator and an overcurrent comparator.

The UCC2800 family contains digital current sense filtering, which disconnects the CS terminal from the current sense comparator during the 100 ns interval immediately following the rising edge of the OUT pin. This digital filtering, also called leading-edge blanking, means that in most applications, no analog filtering (RC filter) is required on CS. Compared to an external RC filter technique, the leading-edge blanking provides a smaller effective CS to OUT propagation delay. Note, however, that the minimum non-zero on-time of the OUT signal is directly affected by the leading-edge-blanking and the CS to OUT propagation delay.

The overcurrent comparator is only intended for fault sensing, and exceeding the over-current threshold will cause a soft start cycle.

FB

FB is the inverting input of the error amplifier. For best stability, keep FB lead length as short as possible and FB stray capacitance as small as possible.

ground (GND)

GND is reference ground and power ground for all functions on this part.

OUT

OUT is the output of a high-current power driver capable of driving the gate of a power MOSFET with peak currents exceeding 750 mA. OUT is actively held low when V_{CC} is below the UVLO threshold.

The high-current power driver consists of FET output devices, which can switch all of the way to GND and all of the way to V_{CC} . The output stage also provides a low impedance to overshoot and undershoot. This means that in many cases, external schottky clamp diodes are not required.

UCC2800/2801/2802/2803/2804/2805-EP

LOW-POWER BICMOS CURRENT-MODE PWM

SGLS135F – SEPTEMBER 2002 – REVISED OCTOBER 2010

detailed descriptions (continued)

RC

RC is the oscillator timing pin. For fixed frequency operation, set timing capacitor charging current by connecting a resistor from REF to RC. Set frequency by connecting timing capacitor from RC to GND. For the best performance, keep the timing capacitor lead to GND as short and direct as possible. If possible, use separate ground traces for the timing capacitor and all other functions.

The frequency of oscillation can be estimated with the following equations:

$$\text{UCC2800/01/02/04} : F = \frac{1.5}{R \times C}$$

$$\text{UCC2803/UCC2805} : F = \frac{1.0}{R \times C}$$

(1)

where frequency is in Hz, resistance is in ohms, and capacitance is in farads. The recommended range of timing resistors is between 10k and 200k and timing capacitor is 100 pF to 1000 pF. Never use a timing resistor less than 10k.

To prevent noise problems, bypass V_{CC} to GND with a ceramic capacitor as close to the V_{CC} pin as possible. An electrolytic capacitor may also be used in addition to the ceramic capacitor.

voltage reference (REF)

REF is the voltage reference for the error amplifier and also for many other functions on the IC. REF is also used as the logic power supply for high speed switching logic on the IC.

When V_{CC} is greater than 1 V and less than the UVLO threshold, REF is pulled to ground through a 5 k Ω resistor. This means that REF can be used as a logic output indicating power system status. It is important for reference stability that REF is bypassed to GND with a ceramic capacitor as close to the pin as possible. An electrolytic capacitor may also be used in addition to the ceramic capacitor. A minimum of 0.1 μ F ceramic is required. Additional REF bypassing is required for external loads greater than 2.5 mA on the reference.

To prevent noise problems with high speed switching transients, bypass REF to ground with a ceramic capacitor close to the IC package.

power (V_{CC})

V_{CC} is the power input connection for this device. In normal operation, V_{CC} is powered through a current limiting resistor. Although quiescent V_{CC} current is very low, total supply current will be higher, depending on the OUT current. Total V_{CC} current is the sum of quiescent V_{CC} current and the average OUT current. Knowing the operating frequency and the MOSFET gate charge (Q_g), average OUT current can be calculated from:

$$I_{OUT} = Q_g \times F$$

(2)



PARAMETER MEASUREMENT INFORMATION

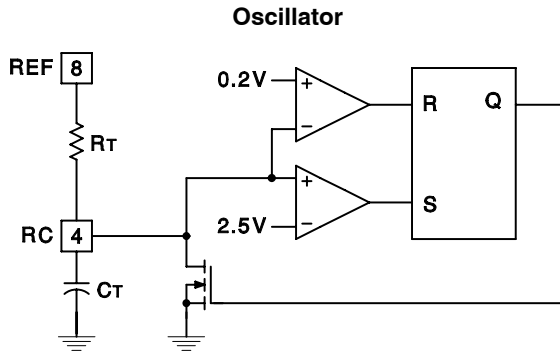

The UCC3800/1/2/3/4/5 oscillator generates a sawtooth waveform on RC. The rise time is set by the time constant of R_T and C_T . The fall time is set by C_T and an internal transistor on-resistance of approximately 125. During the fall time, the output is off and the maximum duty cycle is reduced below 50% or 100% depending on the part number. Larger timing capacitors increase the discharge time and reduce the maximum duty cycle and frequency.

Figure 1

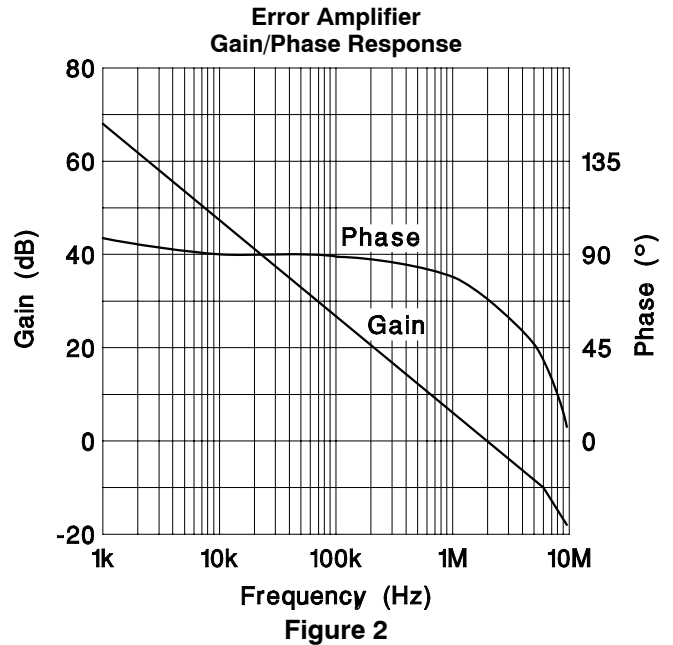

Figure 2

UCC1803/05 V_{REF} vs V_{CC} ; $I_{LOAD} = 0.5$ mA

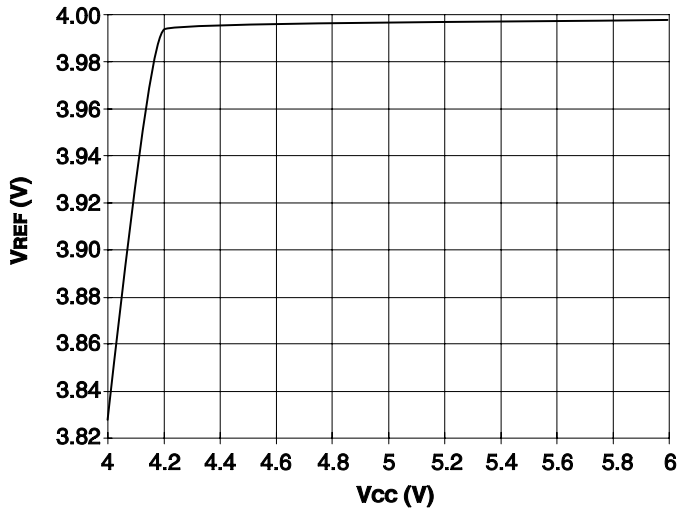

Figure 3

UCC1800/01/02/04 Oscillator Frequency vs R_T and C_T

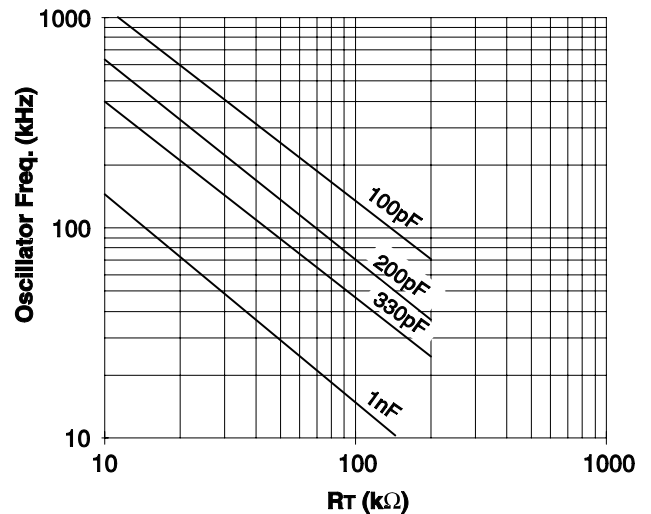
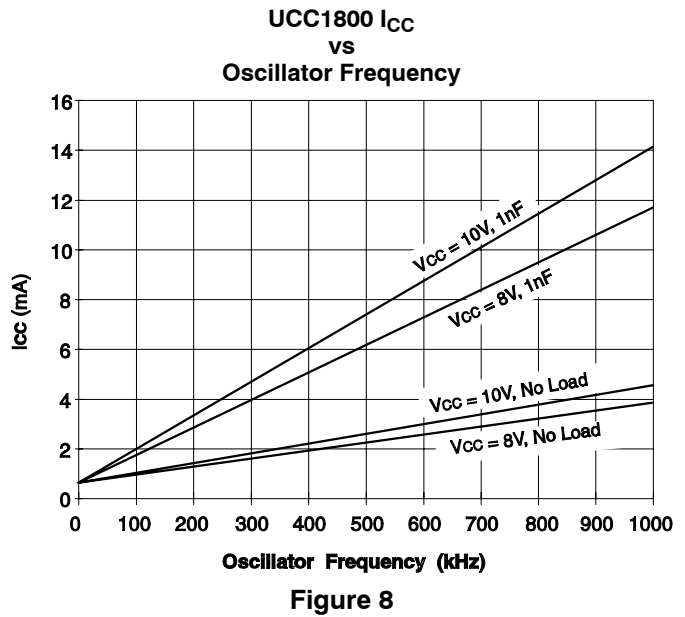
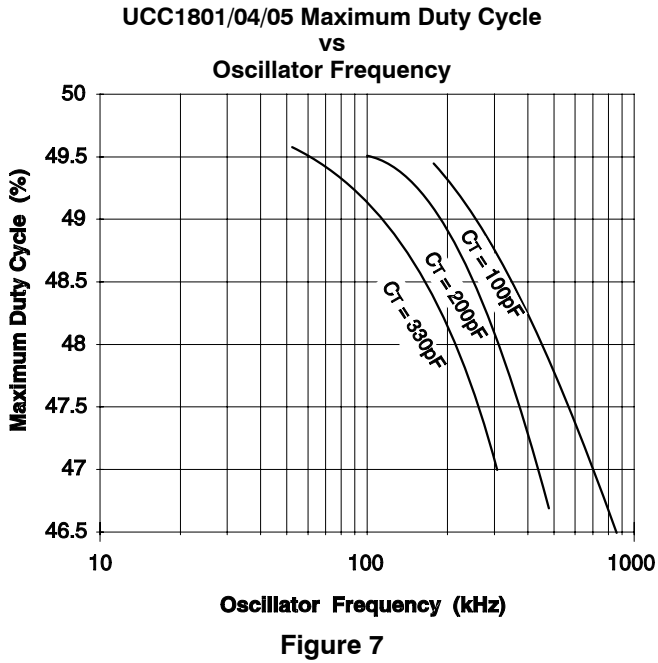
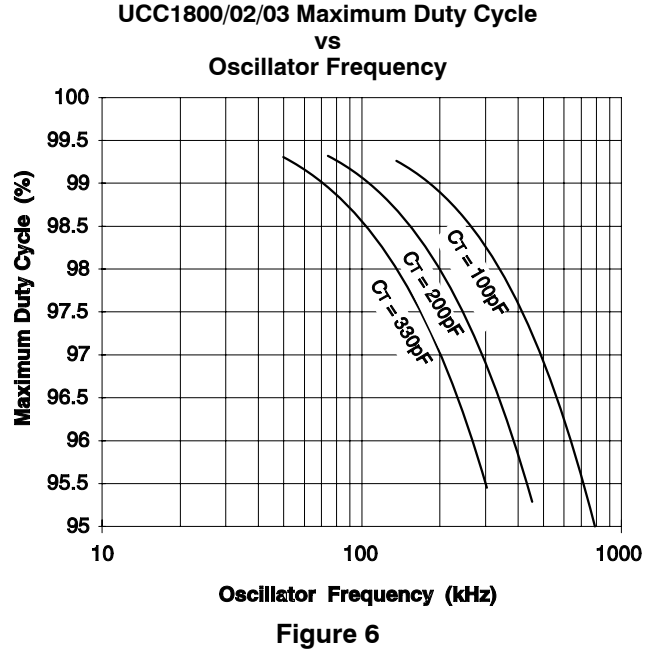
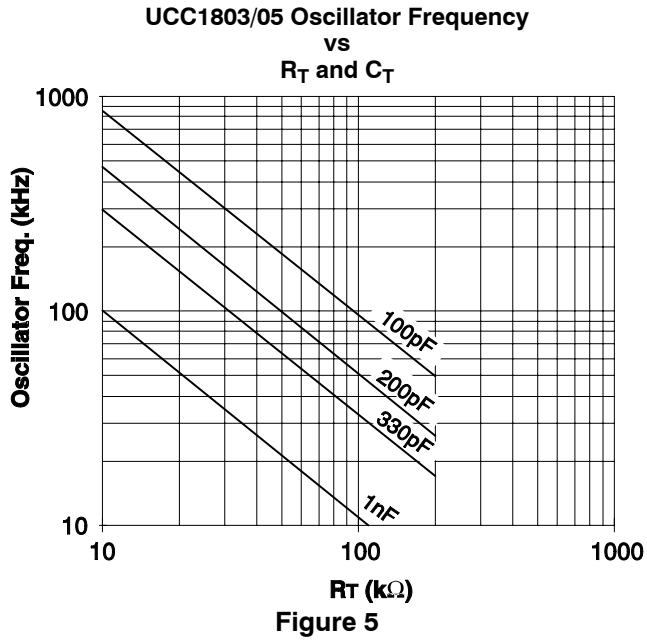

Figure 4

UCC2800/2801/2802/2803/2804/2805-EP LOW-POWER BICMOS CURRENT-MODE PWM

SGLS135F – SEPTEMBER 2002 – REVISED OCTOBER 2010

PARAMETER MEASUREMENT INFORMATION



PARAMETER MEASUREMENT INFORMATION

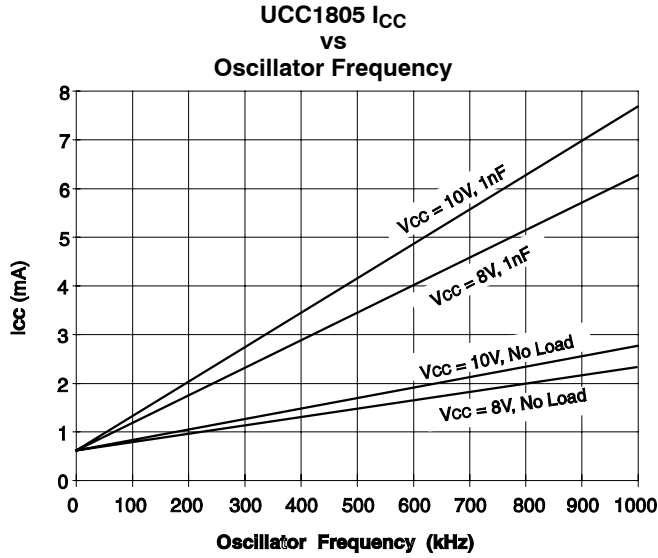

Figure 9

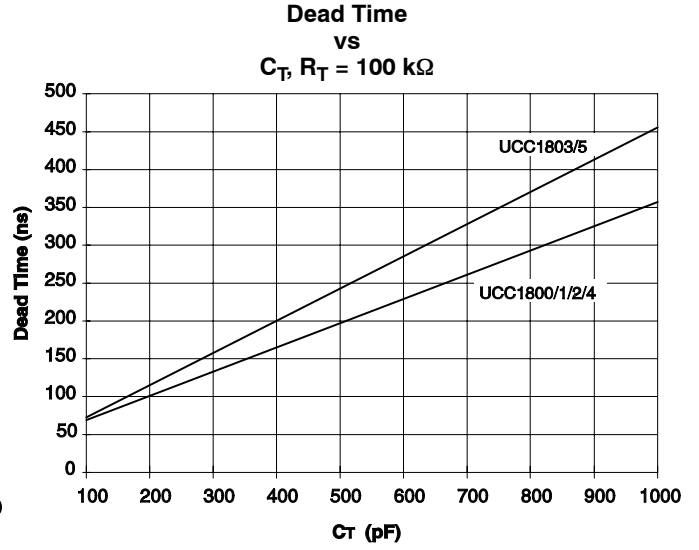

Figure 10

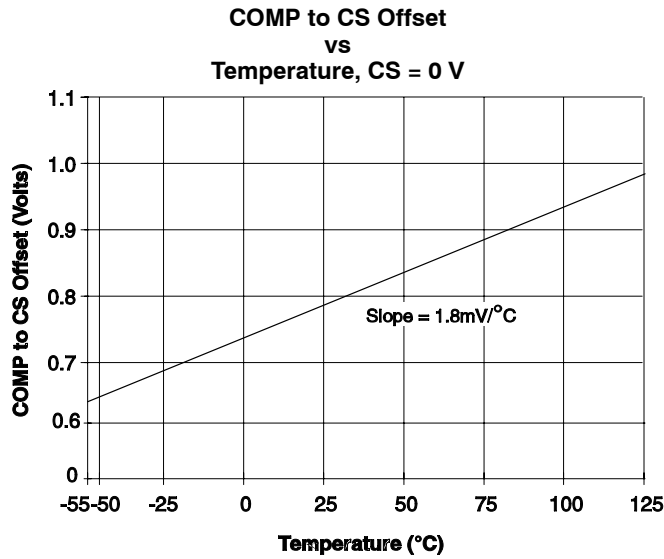

Figure 11

UCC2800/2801/2802/2803/2804/2805-EP LOW-POWER BICMOS CURRENT-MODE PWM

SGLS135F – SEPTEMBER 2002 – REVISED OCTOBER 2010

MECHANICAL DATA

D (R-PDSO-G**)

PLASTIC SMALL-OUTLINE PACKAGE

8 PINS SHOWN

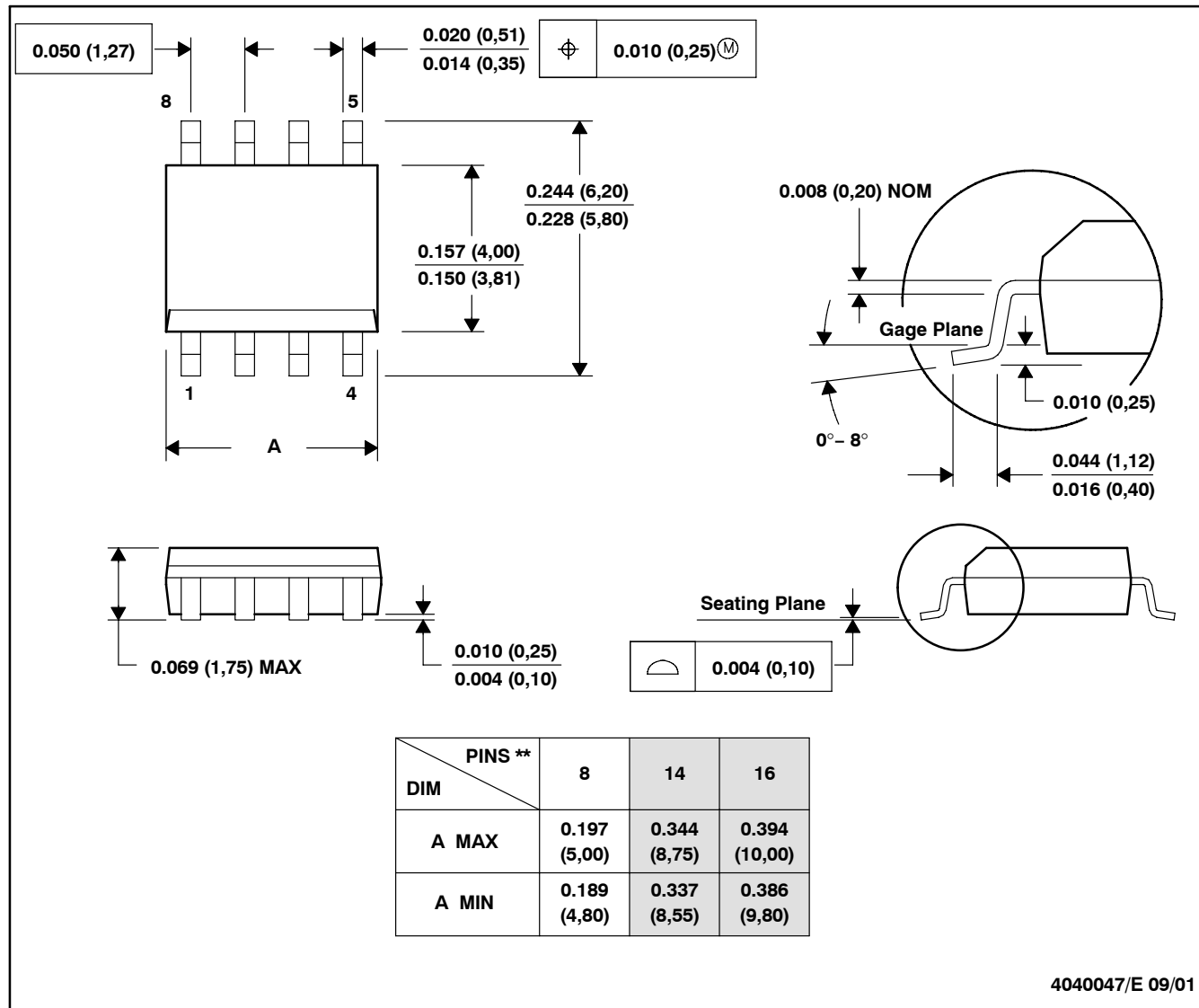

- NOTES: A. All linear dimensions are in inches (millimeters).
 B. This drawing is subject to change without notice.
 C. Body dimensions do not include mold flash or protrusion, not to exceed 0.006 (0,15).
 D. Falls within JEDEC MS-012

PACKAGING INFORMATION

Orderable Device	Status (1)	Package Type	Package Drawing	Pins	Package Qty	Eco Plan (2)	Lead finish/ Ball material (6)	MSL Peak Temp (3)	Op Temp (°C)	Device Marking (4/5)	Samples
UCC2800MDREP	ACTIVE	SOIC	D	8	2500	RoHS & Green	NIPDAU	Level-1-260C-UNLIM	-55 to 125	2800EP	Samples
UCC2800QDREP	ACTIVE	SOIC	D	8	2500	RoHS & Green	NIPDAU	Level-1-260C-UNLIM	-40 to 125	(C2800D, C2800DEP) EP	Samples
UCC2801MDREP	ACTIVE	SOIC	D	8	2500	RoHS & Green	NIPDAU	Level-1-260C-UNLIM	-55 to 125	2801EP	Samples
UCC2801QDREP	ACTIVE	SOIC	D	8	2500	RoHS & Green	NIPDAU	Level-1-260C-UNLIM	-40 to 125	2801EP	Samples
UCC2802QDREP	ACTIVE	SOIC	D	8	2500	RoHS & Green	NIPDAU	Level-1-260C-UNLIM	-40 to 125	2802EP	Samples
UCC2803MDREP	ACTIVE	SOIC	D	8	2500	RoHS & Green	NIPDAU	Level-1-260C-UNLIM	-55 to 125	2803EP	Samples
UCC2803QDREP	ACTIVE	SOIC	D	8	2500	RoHS & Green	NIPDAU	Level-1-260C-UNLIM	-40 to 125	2803EP	Samples
UCC2804QDREP	ACTIVE	SOIC	D	8	2500	RoHS & Green	NIPDAU	Level-1-260C-UNLIM	-40 to 125	2804EP	Samples
UCC2805QDREP	ACTIVE	SOIC	D	8	2500	RoHS & Green	NIPDAU	Level-1-260C-UNLIM	-40 to 125	2805EP	Samples
V62/03624-01XE	ACTIVE	SOIC	D	8	2500	RoHS & Green	NIPDAU	Level-1-260C-UNLIM	-40 to 125	(C2800D, C2800DEP) EP	Samples
V62/03624-02XE	ACTIVE	SOIC	D	8	2500	RoHS & Green	NIPDAU	Level-1-260C-UNLIM	-40 to 125	2801EP	Samples
V62/03624-03XE	ACTIVE	SOIC	D	8	2500	RoHS & Green	NIPDAU	Level-1-260C-UNLIM	-40 to 125	2802EP	Samples
V62/03624-04XE	ACTIVE	SOIC	D	8	2500	RoHS & Green	NIPDAU	Level-1-260C-UNLIM	-40 to 125	2803EP	Samples
V62/03624-05XE	ACTIVE	SOIC	D	8	2500	RoHS & Green	NIPDAU	Level-1-260C-UNLIM	-40 to 125	2804EP	Samples
V62/03624-06XE	ACTIVE	SOIC	D	8	2500	RoHS & Green	NIPDAU	Level-1-260C-UNLIM	-40 to 125	2805EP	Samples
V62/03624-07XE	ACTIVE	SOIC	D	8	2500	RoHS & Green	NIPDAU	Level-1-260C-UNLIM	-55 to 125	2801EP	Samples
V62/03624-08XE	ACTIVE	SOIC	D	8	2500	RoHS & Green	NIPDAU	Level-1-260C-UNLIM	-55 to 125	2803EP	Samples
V62/03624-09XE	ACTIVE	SOIC	D	8	2500	RoHS & Green	NIPDAU	Level-1-260C-UNLIM	-55 to 125	2800EP	Samples

(1) The marketing status values are defined as follows:

ACTIVE: Product device recommended for new designs.

LIFEBUY: TI has announced that the device will be discontinued, and a lifetime-buy period is in effect.

NRND: Not recommended for new designs. Device is in production to support existing customers, but TI does not recommend using this part in a new design.

PREVIEW: Device has been announced but is not in production. Samples may or may not be available.

OBSOLETE: TI has discontinued the production of the device.

(2) **RoHS:** TI defines "RoHS" to mean semiconductor products that are compliant with the current EU RoHS requirements for all 10 RoHS substances, including the requirement that RoHS substance do not exceed 0.1% by weight in homogeneous materials. Where designed to be soldered at high temperatures, "RoHS" products are suitable for use in specified lead-free processes. TI may reference these types of products as "Pb-Free".

RoHS Exempt: TI defines "RoHS Exempt" to mean products that contain lead but are compliant with EU RoHS pursuant to a specific EU RoHS exemption.

Green: TI defines "Green" to mean the content of Chlorine (Cl) and Bromine (Br) based flame retardants meet JS709B low halogen requirements of ≤ 1000 ppm threshold. Antimony trioxide based flame retardants must also meet the ≤ 1000 ppm threshold requirement.

(3) MSL, Peak Temp. - The Moisture Sensitivity Level rating according to the JEDEC industry standard classifications, and peak solder temperature.

(4) There may be additional marking, which relates to the logo, the lot trace code information, or the environmental category on the device.

(5) Multiple Device Markings will be inside parentheses. Only one Device Marking contained in parentheses and separated by a "-" will appear on a device. If a line is indented then it is a continuation of the previous line and the two combined represent the entire Device Marking for that device.

(6) Lead finish/Ball material - Orderable Devices may have multiple material finish options. Finish options are separated by a vertical ruled line. Lead finish/Ball material values may wrap to two lines if the finish value exceeds the maximum column width.

Important Information and Disclaimer: The information provided on this page represents TI's knowledge and belief as of the date that it is provided. TI bases its knowledge and belief on information provided by third parties, and makes no representation or warranty as to the accuracy of such information. Efforts are underway to better integrate information from third parties. TI has taken and continues to take reasonable steps to provide representative and accurate information but may not have conducted destructive testing or chemical analysis on incoming materials and chemicals. TI and TI suppliers consider certain information to be proprietary, and thus CAS numbers and other limited information may not be available for release.

In no event shall TI's liability arising out of such information exceed the total purchase price of the TI part(s) at issue in this document sold by TI to Customer on an annual basis.

OTHER QUALIFIED VERSIONS OF UCC2800-EP, UCC2801-EP, UCC2802-EP, UCC2803-EP, UCC2804-EP, UCC2805-EP :

● Catalog: [UCC2800](#), [UCC2801](#), [UCC2802](#), [UCC2803](#), [UCC2804](#), [UCC2805](#)

● Automotive: [UCC2800-Q1](#), [UCC2801-Q1](#), [UCC2802-Q1](#), [UCC2803-Q1](#), [UCC2804-Q1](#), [UCC2805-Q1](#)

● Military: [UCC2802M](#)

NOTE: Qualified Version Definitions:

- Catalog - TI's standard catalog product
- Automotive - Q100 devices qualified for high-reliability automotive applications targeting zero defects
- Military - QML certified for Military and Defense Applications

TAPE AND REEL INFORMATION



QUADRANT ASSIGNMENTS FOR PIN 1 ORIENTATION IN TAPE



*All dimensions are nominal

Device	Package Type	Package Drawing	Pins	SPQ	Reel Diameter (mm)	Reel Width W1 (mm)	A0 (mm)	B0 (mm)	K0 (mm)	P1 (mm)	W (mm)	Pin1 Quadrant
UCC2800MDREP	SOIC	D	8	2500	330.0	12.4	6.4	5.2	2.1	8.0	12.0	Q1
UCC2800QDREP	SOIC	D	8	2500	330.0	12.4	6.4	5.2	2.1	8.0	12.0	Q1
UCC2801MDREP	SOIC	D	8	2500	330.0	12.4	6.4	5.2	2.1	8.0	12.0	Q1
UCC2801QDREP	SOIC	D	8	2500	330.0	12.4	6.4	5.2	2.1	8.0	12.0	Q1
UCC2802QDREP	SOIC	D	8	2500	330.0	12.4	6.4	5.2	2.1	8.0	12.0	Q1
UCC2803MDREP	SOIC	D	8	2500	330.0	12.4	6.4	5.2	2.1	8.0	12.0	Q1
UCC2803QDREP	SOIC	D	8	2500	330.0	12.4	6.4	5.2	2.1	8.0	12.0	Q1
UCC2804QDREP	SOIC	D	8	2500	330.0	12.4	6.4	5.2	2.1	8.0	12.0	Q1
UCC2805QDREP	SOIC	D	8	2500	330.0	12.4	6.4	5.2	2.1	8.0	12.0	Q1

TAPE AND REEL BOX DIMENSIONS

*All dimensions are nominal

Device	Package Type	Package Drawing	Pins	SPQ	Length (mm)	Width (mm)	Height (mm)
UCC2800MDREP	SOIC	D	8	2500	350.0	350.0	43.0
UCC2800QDREP	SOIC	D	8	2500	350.0	350.0	43.0
UCC2801MDREP	SOIC	D	8	2500	350.0	350.0	43.0
UCC2801QDREP	SOIC	D	8	2500	350.0	350.0	43.0
UCC2802QDREP	SOIC	D	8	2500	350.0	350.0	43.0
UCC2803MDREP	SOIC	D	8	2500	350.0	350.0	43.0
UCC2803QDREP	SOIC	D	8	2500	350.0	350.0	43.0
UCC2804QDREP	SOIC	D	8	2500	350.0	350.0	43.0
UCC2805QDREP	SOIC	D	8	2500	350.0	350.0	43.0

IMPORTANT NOTICE AND DISCLAIMER

TI PROVIDES TECHNICAL AND RELIABILITY DATA (INCLUDING DATASHEETS), DESIGN RESOURCES (INCLUDING REFERENCE DESIGNS), APPLICATION OR OTHER DESIGN ADVICE, WEB TOOLS, SAFETY INFORMATION, AND OTHER RESOURCES "AS IS" AND WITH ALL FAULTS, AND DISCLAIMS ALL WARRANTIES, EXPRESS AND IMPLIED, INCLUDING WITHOUT LIMITATION ANY IMPLIED WARRANTIES OF MERCHANTABILITY, FITNESS FOR A PARTICULAR PURPOSE OR NON-INFRINGEMENT OF THIRD PARTY INTELLECTUAL PROPERTY RIGHTS.

These resources are intended for skilled developers designing with TI products. You are solely responsible for (1) selecting the appropriate TI products for your application, (2) designing, validating and testing your application, and (3) ensuring your application meets applicable standards, and any other safety, security, or other requirements. These resources are subject to change without notice. TI grants you permission to use these resources only for development of an application that uses the TI products described in the resource. Other reproduction and display of these resources is prohibited. No license is granted to any other TI intellectual property right or to any third party intellectual property right. TI disclaims responsibility for, and you will fully indemnify TI and its representatives against, any claims, damages, costs, losses, and liabilities arising out of your use of these resources.

TI's products are provided subject to TI's Terms of Sale (www.ti.com/legal/termsofsale.html) or other applicable terms available either on ti.com or provided in conjunction with such TI products. TI's provision of these resources does not expand or otherwise alter TI's applicable warranties or warranty disclaimers for TI products.

Mailing Address: Texas Instruments, Post Office Box 655303, Dallas, Texas 75265
Copyright © 2020, Texas Instruments Incorporated