



Low Profile Bayonet Connectors MIL-DTL-38999 Series II



Presentation

38999 bayonet circular connector for more compacity

The design and performances of the 8T connectors meet the most severe requirements set for applications in military and civil aerospace. With the increasing requirement for Space, Weight and Power (SWaP) reduction, SOURIAU has more than doubled its 8T range. It features:

- Lower profile design: Lightweight, space saving (30% shorter compared to 8LT Series)
- High reliability: EMI shielding, excellent shock vibration and fluid resistance, QPL approved
- A high contact density: From 1 to 128 contacts
- A wide range: 11 different shells available, 43 layouts available from size 8 to 24

Contents

Overview

Typical applications	6
Features & Benefits	7
A large offer	8
Main characteristics	9
A versatile range available	9
A universal product platform	10
Contact layouts	13

Standard Series

Technical features	16
Ordering information	17
Dimensions	19
Aluminum backshells	24
Aluminum protective caps	27

Common Section

Contacts / Filler plugs	30
Tooling / Wiring instruction	31
Gaskets	33
Orientations	33
Dummy receptacles	33
Backshells assembly	34
Coordinates for PC tail contacts	36
Cross reference list	45

Range Extension

Box mount interconnect solutions	48
Rack and panel	48
<i>microComp</i> ® Series	49
Double flange	49
Integrated clinch nut or helicoils	50
PC tail contacts without shoulder	50

8T SERIES

8T Series

Overview

■ Typical applications	6
■ Features & Benefits	7
■ A large offer	8
■ Main characteristics	9
■ A versatile range available	9
■ A universal product platform	10
■ Worldwide sales network	10
■ Contact layouts	11
■ Contact layouts (matrix)	13

Typical applications



Civil and Military Aerospace



Missiles and Weapon Systems



Armored Carrier and Tanks



Communication Equipment



Medical Instrumentation



Marine Equipment

Features & Benefits

QPL

MIL-DTL-38999 Qualified

39 qualified layouts.
High reliability: EMI shielding, excellent shock vibration and fluid resistance.

**QUICK
MATING**

Fast and secure mating

Bayonet quick coupling system.
Audible, sensitive and visible coupling.

**LOW
PROFILE**

Space and weight saving

Lower profile connector design: integrated backshell and short grommet versions.
30% shorter compared to 38999 Series I.

**LARGE
OFFER**

Versatility

11 different shells, 43 layouts available from size 8 to 24.
High contact density: from 1 to 128 contacts.
Crimp contacts with rear release and a retainer metallic clip.

RoHS

Environment friendly

RoHS black zinc nickel plating available.
RoHS nickel plating available.

A large offer

PLUGS

Plug with grounding ring

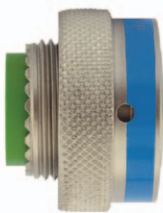

8T5
MS27484T

Plug without grounding ring

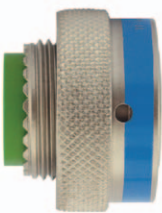

8T6
MS27473T



8T15



8T16

RECEPTACLES

Square flange receptacle front mounting



8T0
MS27472T



8T4
MS27499E



8T10

Square flange receptacle rear mounting



8T3
MS27497T



8T2
MS27508E

In line receptacle



8T1

Jam nut receptacle

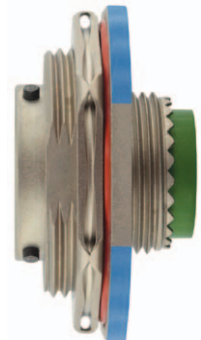

8T7
MS27474T

PC Tail
receptacles
available



ACCESSORIES

Backshells

6 styles of backshells,
Straight or right angle,
4 platings available

Please see page 24.



Metallic caps

Caps for plug or receptacle,
Cord with eyelet or ring
2 platings available

Please see page 27.

Main characteristics

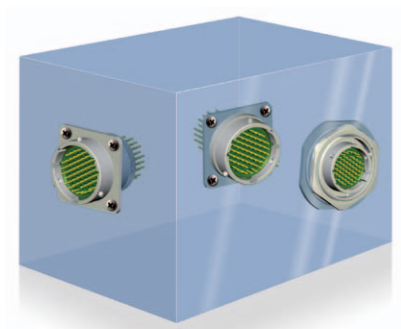

Versatility

Square flange **rear mounting**,
Square flange **front mounting**,
Integrated backshell,
Jam nut receptacle



30% Shorter

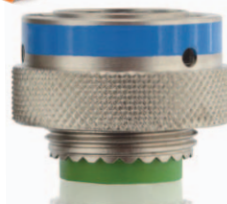

8T
38999 Series II
Example: 8T5



8LT
38999 Series I
Example: 8LT5

Shell size comparison

8T Series shorter for all shell types compared to 8LT Series

A versatile range available

FROM YOUR NEED...



Short grommet

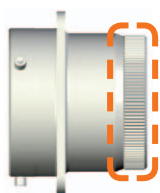

Integrated backshell



With accessory threads

Short grommet		Integrated backshell			With accessory threads					
Receptacle		Receptacle	Plug		Receptacle				Plug	
Square flange + Rear mounting	Square flange + Front mounting	Square flange + Front mounting	With grounding ring	Without grounding ring	Square flange + Front mounting	Square flange + Rear mounting	In line	Jam nut	With grounding ring	Without grounding ring
8T2	8T4	8T10	8T15	8T16	8T0	8T3	8T1	8T7	8T5	8T6

...TO OUR SOLUTION!

A universal product platform

38999
Series I
MIL-DTL-38999
8LT Series



- . High density MIL-spec circular
- . Scoop proof
- . Bayonet coupling
- . Mounting: screws or jam nut
- . Shell: Aluminum alloy
- . Plating: Cadmium or nickel
- . QPL approved
- . Numerous layouts

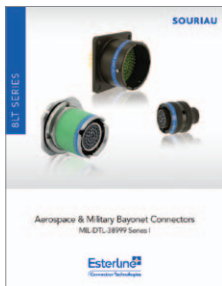

Please consult our
"8LT Series MIL-DTL-38999 Series I"
online catalog on:
www.esterline-connection-technologies.com

38999
Series III
MIL-DTL-38999
8D Series



- . High density MIL-spec circular
- . Scoop proof, fast screw coupling
- . Composite light-weight version
- . Hermetic version
- . QPL approved
- . Quadrax and ELIO® version
- . Specific design: clinch nuts, high power, double flange, ...



Please consult our
"8D Series MIL-DTL-38999 Series III / EN3645"
online catalog on:
www.esterline-connection-technologies.com

VG96912 &
JN1003
8ST Series



- . High density
- . Lightweight version of Series I
- . Scoop proof, bayonet coupling
- . Mounting: screws or jam nut
- . Shell: Aluminum alloy
- . Plating: Cadmium or nickel
- . VG 96912 German specification
- . JN 1003 Typhoon specification



Please consult our
"8ST Series VG96912 / JN1003"
online catalog on:
www.esterline-connection-technologies.com

Worldwide sales network





SOURIAU-SUNBANK is recognized as one of the top international manufacturers of connectors for harsh environment and is continuously strengthening its leading position through its solid structure as an international group. Today the SOURIAU-SUNBANK group has a strong worldwide global presence on 4 continents.

Our international presence is reinforced by franchised and value added distributors in many countries. We also rely upon an extensive network of distributors and resellers worldwide. This coverage, together with a strong commitment towards service, ensures rapid responses to the specific needs of our customers.

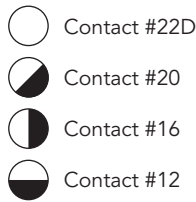
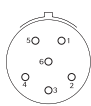

- Operations and Sales Offices
- Value Added Distributors and Franchised

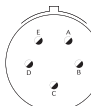
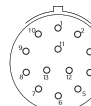
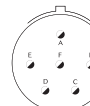
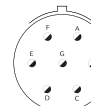
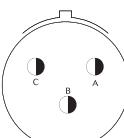
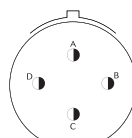
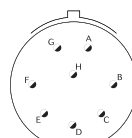
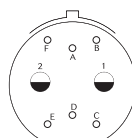
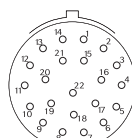
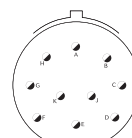
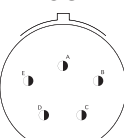
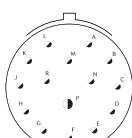
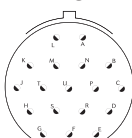
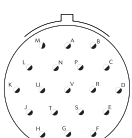
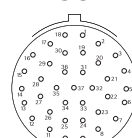
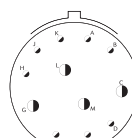
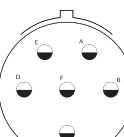
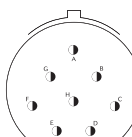
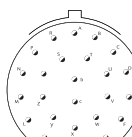
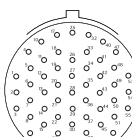
Contact layouts



08		10				
35  6#22D Service M	98  3#20 Service I	05*  5#20 Service I	35  13#22D Service M	98  6#20 Service I	99  7#20 Service I	
12						
03  3#16 Service I	04*  4#16 Service I	08**  8#20 Service I	26*  6#22D 2#12 Service M	35  22#22D Service M	98  10#20 Service I	
14						
05*  5#16 Service II	15*  14#20 1#16 Service I	18*  18#20 Service I	19*  19#20 Service I	35  37#22D Service M	97*  8#20 4#16 Service I	
16						
06  6#12 or 6#12 Coax Service I	08*  8#16 Service II	26*  26#20 Service I	35  55#22D Service M	99  2#16 21#20 Service I		

* Layout not available on 8T2 & 8T4 (short grommet). On demand only, please consult us.

** Layout not available on 8T2 & 8T4 (short grommet) / Layout available on other types (long grommet) but only with male insert. For female version or short grommet, please consult us.

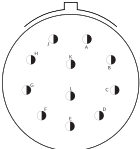
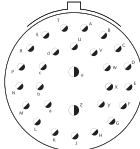
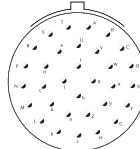
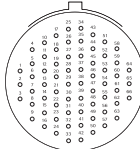
18

<p>11*</p>  <p>11#16 Service II</p>	<p>28</p>  <p>26#20 2#16 Service I</p>	<p>32</p>  <p>32#20 Service I</p>	<p>35</p>  <p>66#22D Service M</p>
---	--	---	--

-  Contact #22D
-  Contact #20
-  Contact #16
-  Contact #12

20

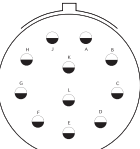
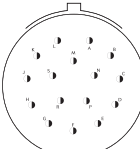
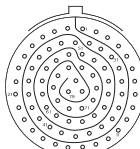
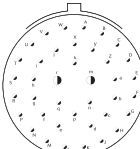
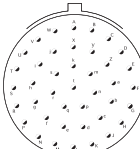
<p>11*</p>  <p>11#12 Service I</p>	<p>16</p>  <p>16#16 Service II</p>	<p>35</p>  <p>79#22D Service M</p>	<p>39</p>  <p>37#20 2#16 Service I</p>	<p>41</p>  <p>41#20 Service I</p>
--	--	--	--	--

22

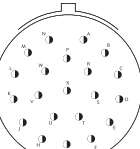
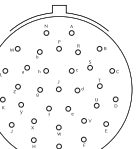
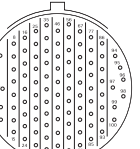
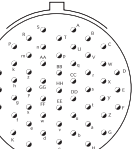
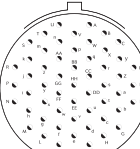
<p>21*</p>  <p>21#16 Service II</p>	<p>32</p>  <p>32#20 Service I</p>	<p>35</p>  <p>100#22D Service M</p>	<p>53*</p>  <p>53#20 Service I</p>	<p>55</p>  <p>55#20 Service I</p>
---	---	---	--	--

24

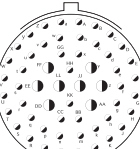
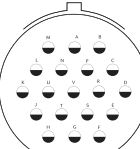
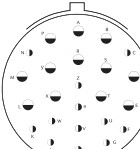
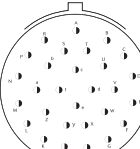
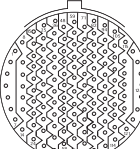
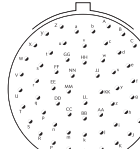
<p>04</p>  <p>48#20 8#16 Service I</p>	<p>19*</p>  <p>19#12 Service I</p>	<p>24*</p>  <p>12#12 12#16 Service I</p>	<p>29*</p>  <p>29#16 Service I</p>	<p>35</p>  <p>128#22D Service M</p>	<p>61*</p>  <p>61#20 Service I</p>
--	--	--	--	--	--

* Layout not available on 8T2 & 8T4 (short grommet). On demand only, please consult us.

Contact layouts (matrix)

Shell Size	Layout	Service	8T	MIL-DTL-38999 (QPL)	HE309	Number of Contacts	#22D	#20	#16	#12
08	08-35	M	OK	Q	Q	6	6			
	08-98	I	OK	Q	Q	3		3		
10	10-05	I	OK	Q ⁽¹⁾		5		5		
	10-35	M	OK	Q	Q	13	13			
	10-98	I	OK	Q	Q	6		6		
	10-99	I	OK	Q		7		7		
12	12-03	I	OK	Q		3			3	
	12-04	I	OK	Q ⁽¹⁾	Q	4			4	
	12-08	I	OK			8		8		
	12-26	M	OK			8	6			2
	12-35	M	OK	Q	Q	22	22			
	12-98	I	OK	Q	Q	10		10		
14	14-05	II	OK	Q ⁽¹⁾	Q	5			5	
	14-15	I	OK	Q ⁽¹⁾		15		14	1	
	14-18	I	OK	Q		18		18		
	14-19	I	OK		Q	19		19		
	14-35	M	OK	Q	Q	37	37			
	14-97	I	OK	Q	Q	12		8	4	
16	16-06	I	OK	Q	Q	6		6 or 6 Coax		
	16-08	II	OK	Q ⁽¹⁾	Q	8			8	
	16-26	I	OK	Q ⁽¹⁾	Q	26		26		
	16-35	M	OK	Q	Q	55	55			
	16-99	I	OK	Q	Q	23		21	2	
18	18-11	II	OK	Q ⁽¹⁾	Q	11			11	
	18-28	I	OK	Q		28		26	2	
	18-32	I	OK	Q	Q	32		32		
	18-35	M	OK	Q	Q	66	66			
20	20-11	I	OK			11				11
	20-16	II	OK	Q	Q	16			16	
	20-35	M	OK	Q	Q	79	79			
	20-39	I	OK	Q ⁽²⁾	Q	39		37	2	
	20-41	I	OK	Q	Q	41		41		
22	22-21	II	OK	Q ⁽¹⁾	Q	21			21	
	22-32	I	OK	Q		32		32		
	22-35	M	OK	Q	Q	100	100			
	22-53	I	OK		Q	53		53		
	22-55	I	OK	Q		55		55		
24	24-04	I	OK	Q		56		48	8	
	24-19	I	OK	Q ⁽¹⁾	Q	19				19
	24-24	II	OK	Q ⁽¹⁾		24			12	12
	24-29	I	OK	Q ⁽¹⁾	Q	29			29	
	24-35	M	OK	Q	Q	128	128			
	24-61	I	OK	Q ⁽¹⁾	Q	61		61		

OK SOURIAU's layout

Q SOURIAU's layout & layout according to corresponding norm

(1) Not qualified for short grommet version (8T2 & 8T4)

(2) Not qualified for 8T4 short grommet version

8T SERIES

8T Series

Standard Series

■ Technical features	16
■ Ordering information	17
■ Dimensions:	
Plugs: 8T5, 8T15, 8T6 & 8T16 types	19
In line receptacle: 8T1 type	20
Jam nut receptacle: 8T7 type	20
Square flange receptacles: 8T0, 8T2, 8T3, 8T4 & 8T10 types	21
■ Receptacle with straight PC tail contacts	23
■ Mated/unmated connectors	23
■ Aluminum backshells	24
■ Aluminum protective caps	27



Description

- Low profile / No scoop proof
- Bayonet locking system
- 11 shell types
- 43 layouts
- High density connector from 1 to 128 contacts
- Excellent shock vibration and fluid resistance
- QPL qualified
- Standards:
 - MIL-C 38999 Series II
 - NFC 93422 HE 309
 - VG 96912 Series II
 - PAN 6433-1
 - BS 9522 N 003

Technical features

Mechanical

- **Shell:** Aluminum alloy
- **Plating:**
 - Black zinc nickel (Z)
 - Nickel (F)
 - Olive green cadmium (B)
 - Hard anodized (C)
- **Insulator:** Thermoplastic
- **Grommet and seal:** Silicone elastomer
- **Contact:** Copper alloy
- **Plating:** Gold over nickel
- **Endurance:**
 - 500 mating cycles
- **Shock:** 300g, 3ms duration
- **Vibration:**
 - Random 100 to 1000Hz - 1g2/Hz
- **Contact retention (mini force in N):**
 - Size 22D: 44N Size 16: 110N
 - Size 20: 67N Size 12: 110N

Electrical

- **Test voltage (Vrms):**

Service	Sea level	at 21 000 m
M	1300	800
I	1800	1000
II	2300	1000

- **Contact resistance:**
 - Size 22D: 14.6mΩ
 - Size 20: 7.3mΩ
 - Size 16: 3.8mΩ
 - Size 12: 3.5mΩ
- **Insulation resistance:**
 - ≥ 5000MΩ (at 500Vdc)
- **Contact rating:**
 - Size 22D: 5A Size 16: 13A
 - Size 20: 7.5A Size 12: 23A
- **Shell continuity (with EMI ring):**
 - Black zinc nickel plating: 2.5mΩ
 - Olive green plating: 2.5mΩ
 - Nickel plating: 1mΩ

Environmental

- **Temperature range:**
 - Zinc nickel plating (Z): -65°C +175°C
 - Cadmium plating (B): -65°C +175°C
 - Nickel plating (F): -65°C +200°C
 - Hard anodized (C): -65°C +200°C
- **Sealing (mated connectors):**
 - Differential pressure 1 bar
 - Leakage ≤ 8cm³/h
- **Salt spray to:**
 - MIL-STD 1344 method 1001:
 - . 500 hours (plating B & Z)
 - . 48 hours (plating F & C)
 - NFC 93422: 48 hours (plating F & C)
- **Damp heat:**
 - MIL-C 38999: 10 cycles (24 hours)
 - NFC 93422: 56 days
- **Resistance to fluids:**
 - To MIL-L 38999:
 - MIL-L 7808, MIL-L 23699, MIL-H 5606,
 - MIL-A 8243, MIL-C 87936, MIL-G 3056,
 - MIL-T 5624 (JP5); hydraulic fluids; solvents
 - To NFC 93422:
 - F 46, F 54, O/180, H 515, H 542, XH 45

Ordering information

SOURIAU part number

Basic Series	8T	0	-	14	B	35	P	N		
Shell type: 0: Square flange receptacle (front mount with accessory threads) 1: In line receptacle (with accessory threads) 2: Square flange receptacle (rear mount without accessory threads) 3: Square flange receptacle (rear mount with accessory threads) 4: Square flange receptacle (front mount without accessory threads) 5: Plug with RFI shielding 6: Plug without RFI shielding 7: Jam nut receptacle (with accessory threads) 10: Square flange receptacle (front mount, rear knurling) 15: Plug with RFI shielding (rear knurling) 16: Plug without RFI shielding (rear knurling)										
Contact style: (for more information please see page 30) -: Connectors with standard crimp contacts L: Receptacle with long PC tail C: Receptacle with short PC tail P: Receptacle with solder cup										
Shell size: 08; 10; 12; 14; 16; 18; 20; 22; 24										
Plating: Z: Black zinc nickel F: Nickel B: Olive drab cadmium C: Hard anodized										
Contact layout: See pages 11 to 13										
Contact type: P: Pin S: Socket A: Connector supplied less pin contact or with specific contacts (connector marking : A + orientation) B: Female connector without contact or with special contacts (connector marking : B + orientation)										
Orientation: N, A, B, C & D										
Special custom: None: Standard plastic cap M: Antistatic plastic cap										
L: For P and S contact type only, connector delivered without contacts, connector marking P or S (without L)										

MIL-DTL-38999 Series II part number

Basic Series	MS	27497T	14	B	35	P			
Shell type & Class:									
27472T: Square flange receptacle (front mount with accessory threads)									
27508E: Square flange receptacle (rear mount without accessory threads)									
27497T: Square flange receptacle (rear mount with accessory threads)									
27499E: Square flange receptacle (front mount without accessory threads)									
27484T: Plug with RFI shielding									
27473T: Plug without RFI shielding									
27474T: Jam nut receptacle (with accessory threads)									
27472E: Square flange receptacle (front mount, with accessory threads and backnut)									
27484E: Plug with RFI shielding (with accessory threads and backnut)									
27473E: Plug without RFI shielding (with accessory threads and backnut)									
Shell size: 08; 10; 12; 14; 16; 18; 20; 22; 24									
Plating:									
Z: Black zinc nickel									
B: Olive drab cadmium									
F: Nickel									
Contact layout: See pages 11 to 13									
Contact type:									
P: Pin									
S: Socket									
A: Connector supplied less pin contact or with specific contacts (connector marking : A + orientation)									
B: Female connector without contact or with special contacts (connector marking : B + orientation)									
Orientation:									
empty: N									
A, B, C & D									
L: For P and S contact type only, connector delivered without contacts, connector marking P or S (without L)									

HE309 Series part number

Basic Series	HE309	03	T	10	35	P	N	6	L
Shell type:									
03: Square flange receptacle with thread for back fitting									
05: Square flange receptacle without thread for back fitting									
06: Plug without RFI shielding									
07: Jam nut receptacle									
Class:									
T: Sealed									
Shell size: 08; 10; 12; 14; 16; 18; 20; 22; 24									
Contact layout: See pages 11 to 13									
Contact type:									
P: Pin									
S: Socket									
Orientation: N, A, B, C & D									
Plating:									
6: Nickel									
7: Olive drab cadmium									
8: Hard anodized									
Specification									
-: Connector delivered with contacts									
L: Connector delivered without contacts									

Dimensions

Plug 8T5 type & 8T15 type



8T5 type
Plug with
accessories thread,
with grounding ring

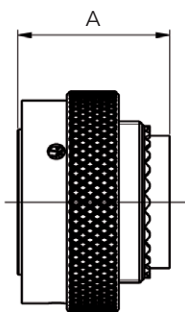

8T5 type

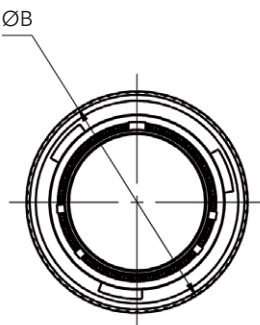

8T5/8T15 types

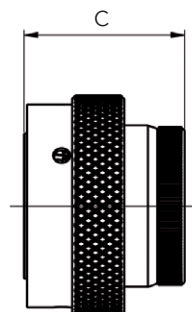

8T15 type

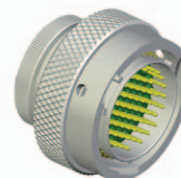

8T15 type
Plug with
integrated backshell,
with grounding ring

Shell size		08	10	12	14	16	18	20	22	24
A	Min.	21.26	21.26	21.26	21.26	21.26	21.26	21.26	21.26	21.26
	Max.	22.59	22.59	22.59	22.59	22.59	22.59	22.59	22.59	22.59
ØB		21.73	24.87	28.93	32.43	35.63	38.43	41.10	44.78	47.93
C	Min.	23.38	23.38	23.38	23.38	23.38	23.38	23.38	23.38	23.38
	Max.	23.57	23.57	23.57	23.57	23.57	23.57	23.57	23.57	23.57

Plug 8T6 type & 8T16 type

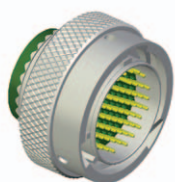

8T6 type
Plug with
accessories thread,
without grounding ring

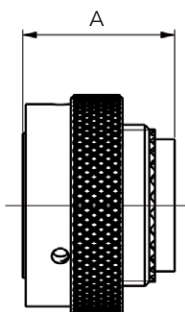

8T6 type

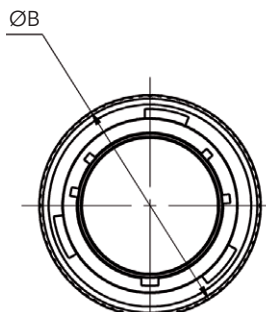

8T6/8T16 types

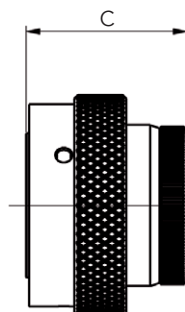

8T16 type

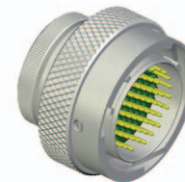

8T16 type
Plug with
integrated backshell,
without grounding ring

Shell size		08	10	12	14	16	18	20	22	24
A	Min.	21.31	21.31	21.31	21.31	21.31	21.31	21.31	21.31	21.31
	Max.	22.65	22.65	22.65	22.65	22.65	22.65	22.65	22.65	22.65
ØB ±0.1		19.03	21.78	26.13	29.33	32.48	35.28	38.83	41.63	44.83
C	Min.	23.43	23.43	23.43	23.43	23.43	23.43	23.43	23.43	23.43
	Max.	23.63	23.63	23.63	23.63	23.63	23.63	23.63	23.63	23.63

Note: All dimensions are in millimeters (mm)

Dimensions

In-line receptacle 8T1 type

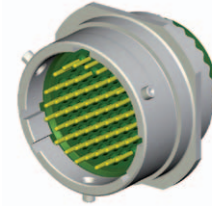
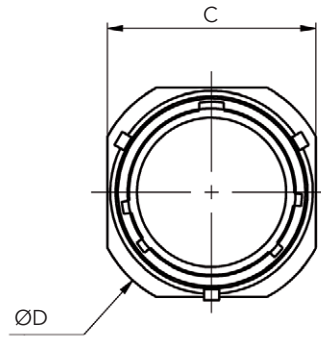
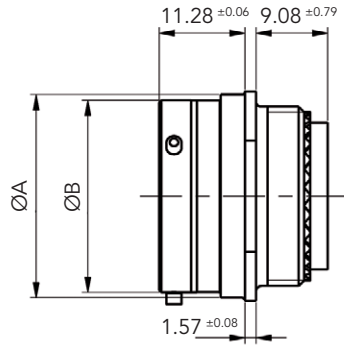

8T1 type
In line receptacle
with accessories thread

Shell size	08	10	12	14	16	18	20	22	24
ØA ±0.07	13.19	16.14	20.43	23.65	26.78	29.95	33.13	36.30	39.50
ØB ±0.08	11.96	14.93	19.00	22.17	25.35	28.52	31.70	34.87	38.05
C ±0.25	14.38	18.68	21.98	25.38	27.58	31.11	34.38	37.78	41.78
ØD ±0.27	17.80	22.10	25.40	28.80	31.00	34.40	37.80	41.20	45.20

Jam nut receptacle 8T7 type

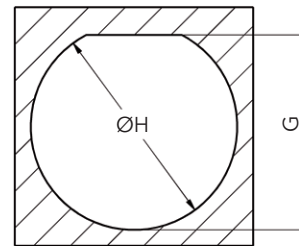
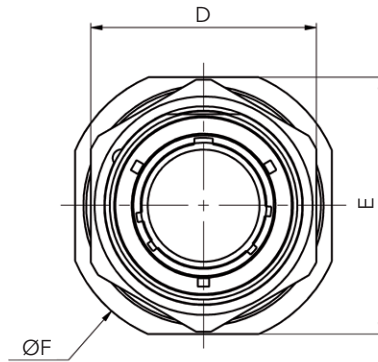
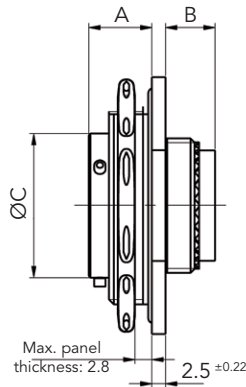

Panel cut-out

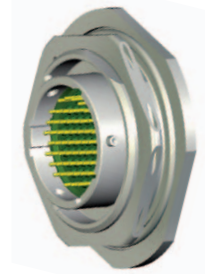

8T7 type
Jam nut receptacle
with accessories thread

Shell size	08	10	12	14	16	18	20	22	24
A ±0.12	11.13	11.13	11.13	11.13	11.13	11.13	11.79	11.79	11.79
B ±0.99	8.36	8.36	8.36	8.36	8.36	8.36	7.70	7.70	7.70
ØC ±0.08	12.01	14.98	19.05	22.22	25.40	28.57	31.75	34.92	38.10
D	27.40	30.61	33.75	36.96	40.10	43.31	46.45	51.23	54.41
E ±0.37	31.85	35.02	38.20	41.37	45.34	48.10	51.30	54.46	57.63
ØF ±0.32	35.05	38.24	41.42	44.59	49.36	51.35	54.50	57.55	60.85
G $0_{-0.25}^{0.25}$	21.08	24.26	27.53	30.68	33.86	37.06	40.03	43.21	46.38
ØH $0_{+0.25}^{0.25}$	22.46	25.58	28.80	31.98	35.15	38.28	41.50	44.68	47.85
Max tightening torque (mN)	9	10	13	20	23	25	26	27	29

Note: All dimensions are in millimeters (mm)

Dimensions

Square flange receptacle 8T0 type, 8T4 type & 8T10 type

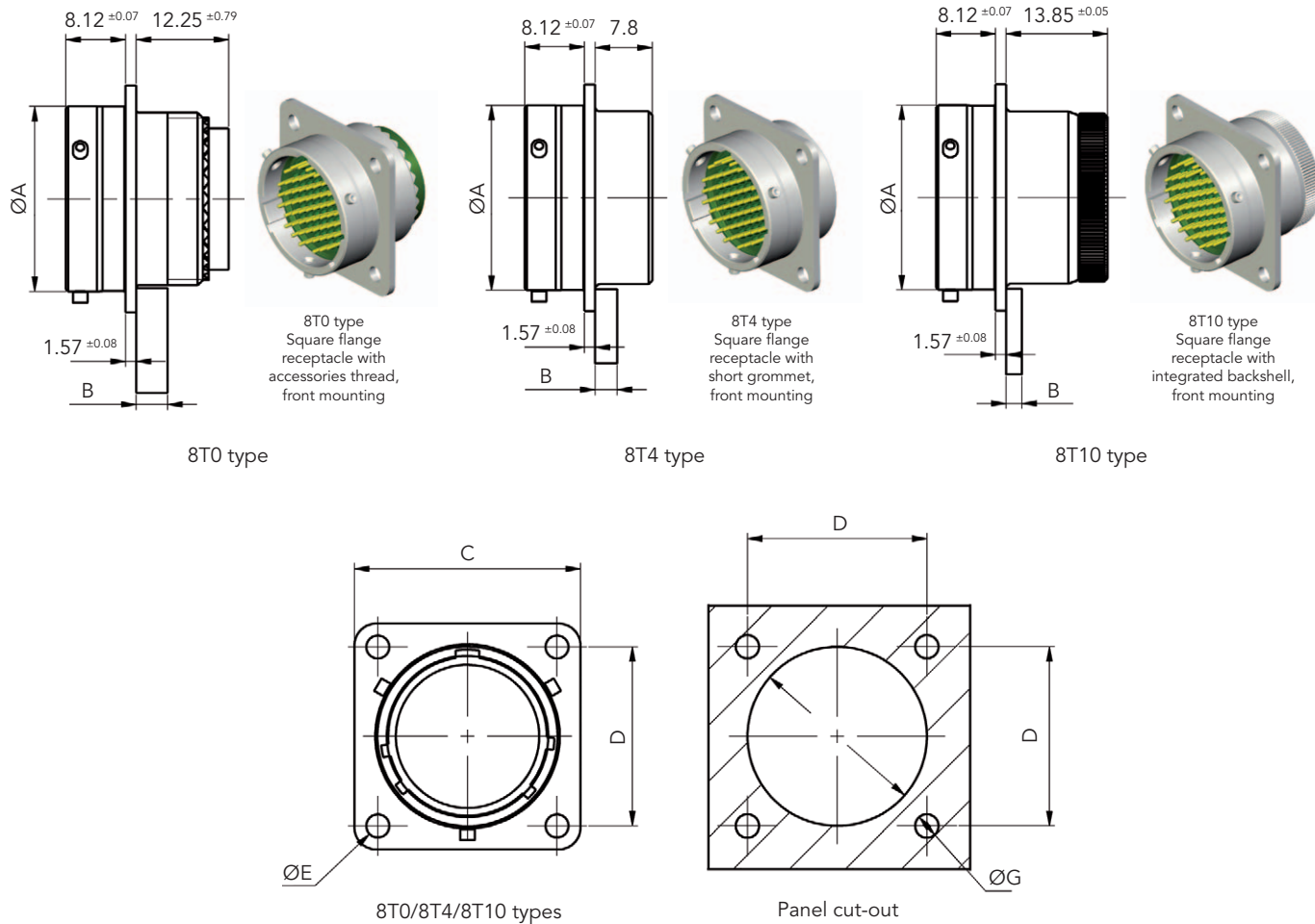

Shell size	08	10	12	14	16	18	20	22	24
ØA ±0.08	12.96	14.93	19.00	22.17	25.35	28.52	31.70	34.87	38.05
B Max.	3.71	3.71	3.71	3.71	3.71	3.71	4.27	4.27	4.27
C	Min.	20.52	23.73	26.11	28.50	30.86	33.22	36.42	39.60
	Max.	21.03	24.23	26.59	28.98	31.34	33.73	36.91	40.08
D	15.09	18.26	20.62	23.01	24.61	26.97	29.36	31.75	34.93
ØE	Min.	3.08	3.08	3.08	3.08	3.08	3.08	3.08	3.71
	Max.	3.30	3.30	3.30	3.30	3.30	3.30	3.30	3.99
ØF	14.15	17.32	21.69	24.87	28.04	31.22	34.39	37.57	40.74
ØG ±0.15	3.25	3.25	3.25	3.25	3.25	3.25	3.25	3.25	3.91

Note: All dimensions are in millimeters (mm)

Dimensions

Square flange receptacle 8T2 type & 8T3 type

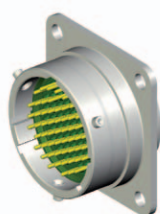
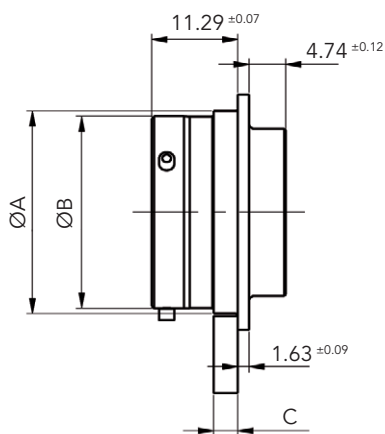

8T2 type
Square flange
receptacle with
short grommet,
rear mounting

8T2 type

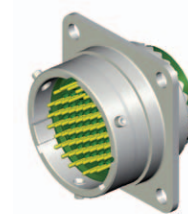
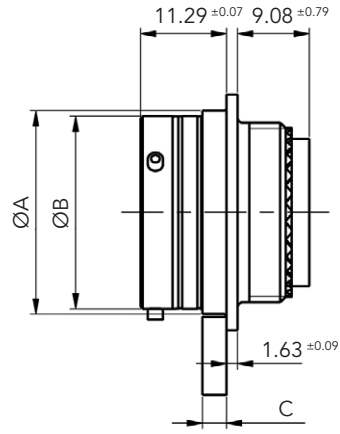

8T3 type
Square flange
receptacle with
accessories thread,
rear mounting

8T3 type

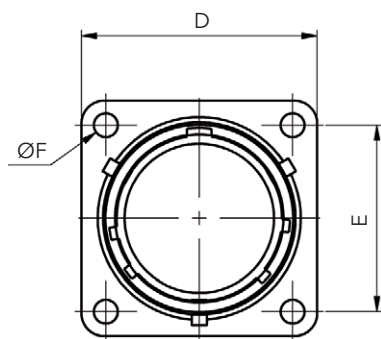

8T2/8T3 types

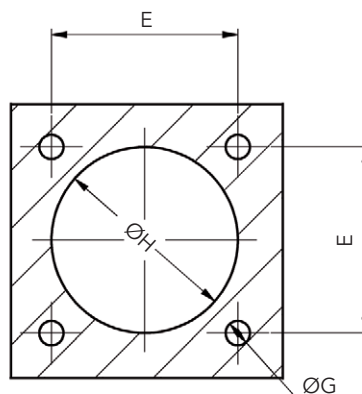

Panel cut-out

Shell size	08	10	12	14	16	18	20	22	24	
ØA ±0.08	13.25	16.20	20.49	23.71	26.84	30.01	33.19	36.36	39.56	
ØB ±0.09	12.02	14.99	19.06	22.25	25.41	28.58	31.76	34.93	38.11	
C Max.	3.71	3.71	3.71	3.71	3.71	3.71	4.27	4.27	4.27	
D	Min.	20.57	23.78	26.16	28.55	30.91	33.27	36.47	39.65	42.82
	Max.	21.10	24.31	26.69	29.08	31.71	34.10	37.28	40.45	43.63
E	15.09	18.26	20.62	23.01	24.61	26.97	29.36	31.75	34.93	
ØF	Min.	3.08	3.08	3.08	3.08	3.08	3.08	3.08	3.71	
	Max.	3.30	3.30	3.30	3.30	3.30	3.30	3.30	3.99	
G ±0.15	3.25	3.25	3.25	3.25	3.25	3.25	3.25	3.25	3.91	
ØH Min.	14.15	17.32	21.69	24.87	28.04	31.22	34.39	37.57	40.74	

Note: All dimensions are in millimeters (mm)

Dimensions

Receptacle with straight PC tail contacts

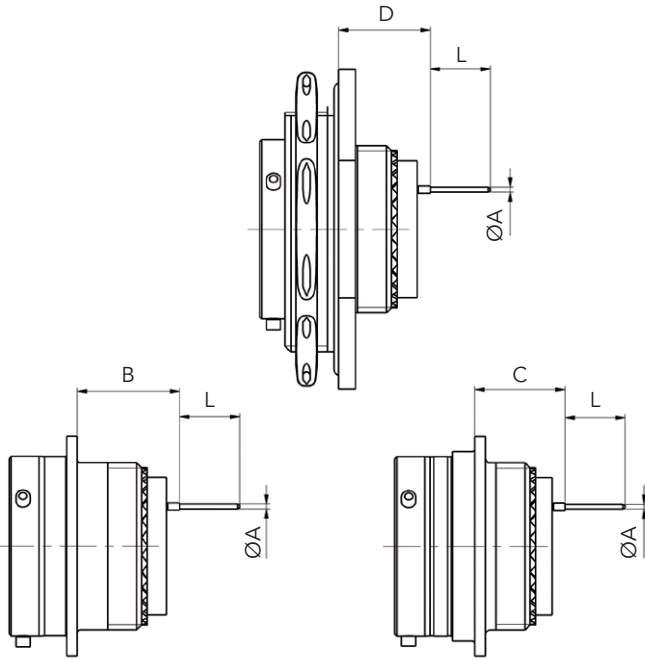

	Contact style			Shell size	
	Size	Type	Length	08 to 18	20 to 24
L _{-0.20}	#22D	M / F	L	8.50	
	#22D	M / F	C	4.00	
	#20 / #16 / #12	M / F	C	5.10	
ØA _{-0.05}	#22D / 20	M / F	C / L	0.70	
	#16	M / F	C / L	1.15	
B	#22D	M	C / L	15.05	
	#22D	F	L	15.05	
	#20 / #16	M	C	15.22	
8T0/8T10 types	#12	M	C	15.22	
	#22D	M	C / L	13.40	
	#22D	F	L	13.40	
8T3 type	#20 / #16	M	C	13.57	
	#12	M	C	13.57	
	#22D	M	C / L	13.61	12.95
8T7 type	#22D	F	L	13.61	12.95
	#20 / #16	M	C	13.78	13.12
	#12	M	C	13.78	

M: Male contact, F: Female contact, C: Short PC tail, L: Long PC tail

Mated/unmated dimensions

8T7 type
with 8T5/8T15/8T6/8T16 types

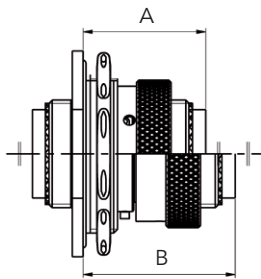

8T1 type
with 8T5/8T15/8T6/8T16 types

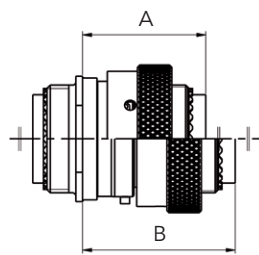

8T2/8T3 types
with 8T5/8T15/8T6/8T16 types

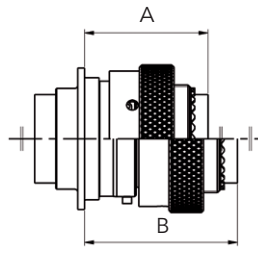

8T0/8T4/8T10 types
with 8T5/8T15/8T6/8T16 types

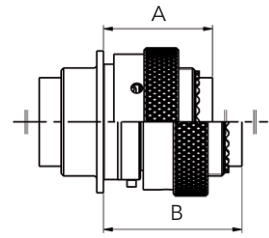

Shell size	8T7 type jam nut receptacle				8T1 type in-line receptacle 8T2/8T3 types square flange receptacle								8T0/8T4/8T10 types square flange receptacle												
	With plug 8T5		With plug 8T6		With plug 8T15		With plug 8T16		With plug 8T5		With plug 8T6		With plug 8T15		With plug 8T16		With plug 8T5		With plug 8T6		With plug 8T15		With plug 8T16		
	A Max.	B Max.	A Max.	B Max.	A Max.	B Max.	A Max.	B Max.	A Max.	B Max.	A Max.	B Max.	A Max.	B Max.	A Max.	B Max.	A Max.	B Max.	A Max.	B Max.	A Max.	B Max.	A Max.	B Max.	
08 to 18	27.68	33.86	27.74	33.92	28.65	34.83	28.71	34.89																	
20 to 24	28.34	34.52	28.40	34.58	29.31	35.49	29.37	35.55	27.77	33.95	27.83	34.01	28.74	34.92	28.80	34.98	24.60	30.78	24.66	30.64	25.57	31.75	25.63	31.81	

Note: All dimensions are in millimeters (mm)

Aluminum backshells

Ordering information

Basic Series	8T	AB	05	A	16	W	S	01	-
Accessories type									
Type:									
01: Backnut	04: Crimp ring								
02: Cable clamp	05: Band lock								
03: Shrink boot	06: Double cone								
Angle:									
A: Straight									
B: 90° (Type 02 only)									
Shell size:									
08, 10, 12, 14, 16, 18, 20, 22, 24									
Finish:									
Z: Black zinc nickel									
W: Olive green cadmium									
F: Nickel									
A: Black anodized									
Self locking option:									
None									
S: Self locking (available for Types 01 & 02 - mandatory for Type 05)									
Cable entry (Type 05 only):									
01, 02 (02 mandatory for shell size 08 & 10)									
Drain hole option:									
None									
D: Drain hole (Type 03 only)									

Assembly instructions

Please see "Common Section" p.34 for assembly instructions and Band-it.

Dimensions

Aluminum backshell Type 01 - Backnut

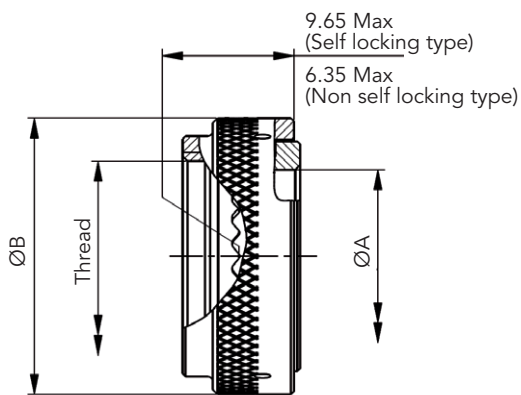

Shell size	ØA Min	ØB Max
08	6.7	17.9
10	9.95	20.9
12	12.85	24.3
14	17.0	27.9
16	19.25	31.3
18	21.7	35.3
20	24.7	38.1
22	27.8	41.5
24	32.0	44.5

Thread: See page 27 for information.

Note: All dimensions are in millimeters (mm)

Aluminum backshells

Aluminum backshell Type 02 - Cable clamp

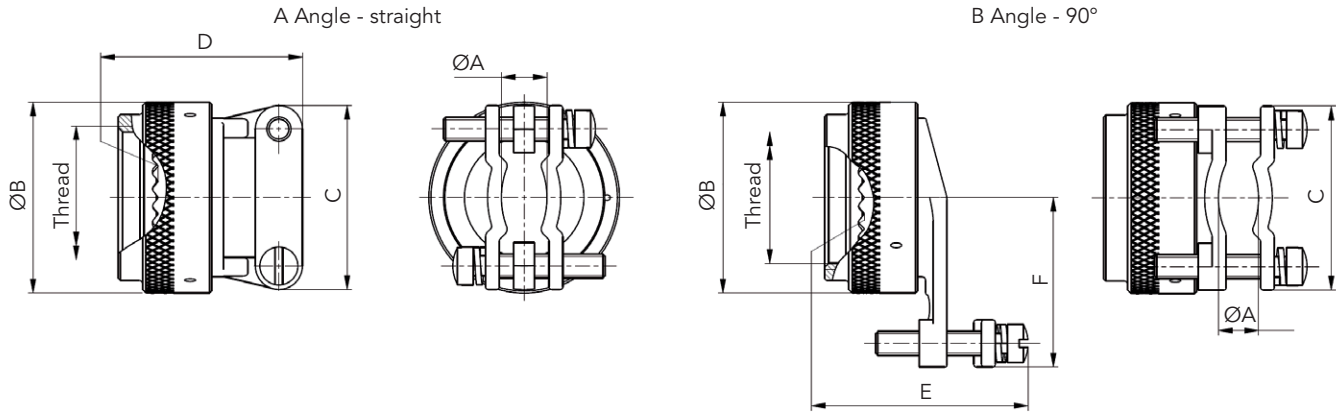

Shell size	ØA		ØB Max	C Max	D Max	E Max	F Max
	Min	Max					
08	2.49	5.94	17.9	21.5	23.1	29.5	20
10	3.89	5.94	20.9	21.5	23.1	29.5	21.5
12	4.83	8.33	24.3	24.5	25.6	31.5	23.5
14	6.60	11.61	27.9	27.5	26.9	35.8	25.5
16	7.19	15.6	31.3	31.5	29.4	40.1	27.5
18	8.26	16.1	35.3	35.5	35.8	40.6	30.5
20	8.71	17.73	38.1	37	38.3	42.7	31.5
22	9.68	20.9	41.5	40.5	42.1	46.2	34.5
24	10.62	21.67	44.5	45	44.7	49	36.5

Thread: See page 27 for information.

Aluminum backshell Type 03 - Shrink boot

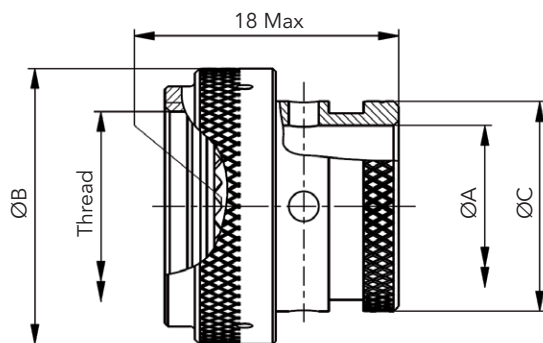

Shell size	ØA Min	ØB Max	C Max
08	6.7	19.0	11.3
10	9.95	21.5	14.9
12	12.85	25.3	17.8
14	16.05	29.1	21.27
16	19.2	31.7	24.3
18	21.5	35.5	26.4
20	24.7	39.3	30.8
22	27.8	41.8	34.1
24	31	46.9	36.6

Thread: See page 27 for information.

Note: All dimensions are in millimeters (mm)

Aluminum backshells

Aluminum backshell Type 04 - Crimp ring

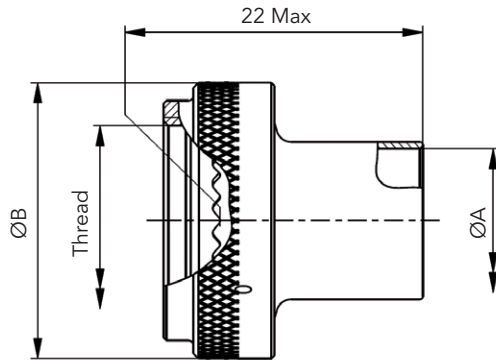

Shell size	ØA Min	ØB Max
08	6	17.9
10	8.2	20.9
12	10.5	24.3
14	13.6	27.9
16	16.9	31.3
18	20	34.3
20	23.2	38.1
22	26.1	41.5
24	28.1	44.4

Thread: See page 27 for information.

Aluminum backshell Type 05 - Band lock

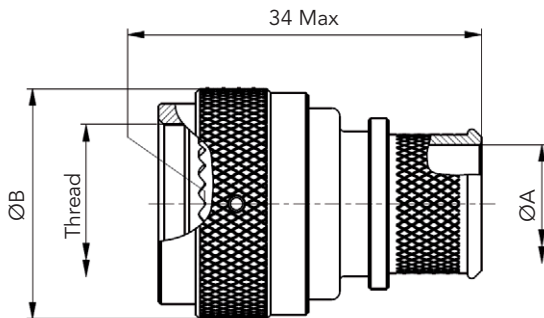

Shell size	ØA Max - Entry size		ØB Max
	01	02	
08	-	6.6	17.9
10	-	8	24.9
12	8	11.2	29.3
14	11.2	14.4	32.4
16	12.8	16	35.6
18	16	19.1	38.4
20	16	20.7	41.6
22	17.6	23.9	44.8
24	19.1	25.5	47.9

Thread: See page 27 for information.

Aluminum backshell Type 06 - Double cone

HE 308 standard - Screen termination and heat shrink boot

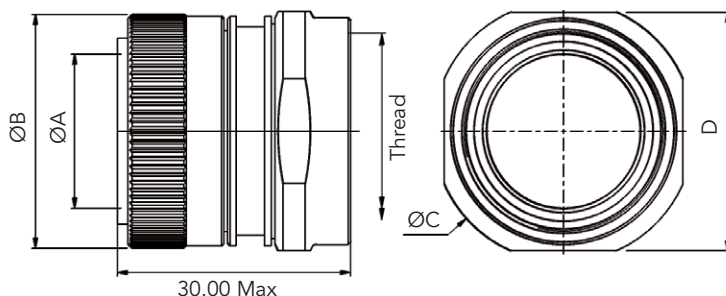

Shell size	ØA±0.07	ØB±0.12	ØC±0.12	D±0.07
08	7.1	15.55	19.35	16.7
10	10.25	18.45	23.35	20.7
12	13.05	21.85	25.35	22.7
14	15.25	25.05	28.35	25.7
16	18.45	28.05	31.35	28.7
18	20.65	31.05	34.35	31.7
20	23.85	34.45	38.35	35.7
22	26.95	37.45	41.35	38.7
24	30.15	40.75	44.35	41.7

Thread: See page 27 for information.

Note: All dimensions are in millimeters (mm)

Aluminum backshells

Recommended installation torque

Shell Size	Installation Torque (Inch-Pounds)
08 to 18	40
20 to 24	80

Note: Torque values are based on 80% of the coupling thread strength specified in SAE-AS85049 standard.

Thread information

Shell size	UNEF Thread
08	7/16-28 2B
10	9/16-24 2B
12	11/16-24 2B
14	13/16-20 2B
16	15/16-20 2B

Shell size	UNEF Thread
18	1 1/16 -18 2B
20	1 3/16 -18 2B
22	1 5/16 -18 2B
24	1 7/16 -18 2B

Aluminum protective caps

Ordering information

Basic Series	8T	E	01	B	14
Cap type:					
E: Cap for receptacle					
F: Cap for plug					
Fixing type:					
Cap for receptacle			Cap for plug		
01: Plastic sleeved metal cord with eyelet			01: Plastic sleeved metal cord with eyelet		
02: Plastic sleeved metal cord with ring					
Plating:					
B: Olive green cadmium					
F: Nickel					
Shell size: 08, 10, 12, 14, 16, 18, 20, 22, 24					

Dimensions

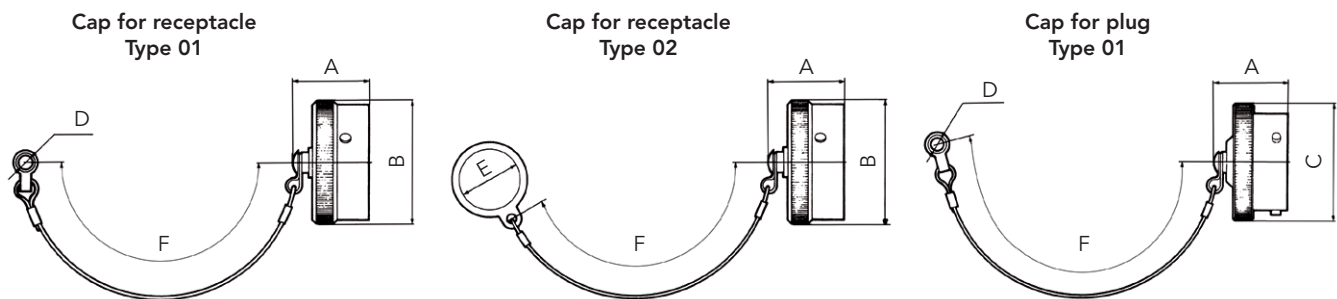

Shell size	08	10	12	14	16	18	20	22	24
Ø A Max.	20.83	20.83	20.83	20.83	20.83	20.83	20.83	20.83	20.83
B Max.	19.05	21.82	26.19	29.36	32.54	35.71	38.89	41.68	44.86
Ø C Max.	18.29	21.59	25.40	28.70	31.75	35.05	38.10	41.40	44.45
Ø D	3.12	3.12	3.12	3.12	3.12	3.12	3.12	3.12	3.53
Ø E	22.61	25.65	28.96	32.00	35.31	38.35	41.66	44.70	48.01
F	76.20	76.20	88.90	88.90	88.90	88.90	101.60	101.60	101.60

Note: All dimensions are in millimeters (mm)

8T SERIES

Common Section

■	Contacts:	
	Crimp contacts	30
	Straight PC tail contacts	30
	Filler plugs	30
■	Tooling:	
	Insertion and extraction tools	31
	Crimping tools	31
	Backshell tightening tools	31
	Tightening support	31
	Slackening tools	31
■	Wiring instruction	32
■	Sealing gaskets	33
■	Orientations	33
■	Dummy receptacles	33
■	Backshells assembly	34
■	Coordinates for straight PC tail terminations	36
■	Cross reference list	45

Contacts

Crimp contacts

Contact size	Contact type	Ø	Conductor section				External Ø over insulator		SOURIAU Part number without color code	MIL-DTL-38999 contacts	
			AWG		mm ²		Min	Max		Part number	Color code
			Min	Max	Min	Max					
#22D	Pin	0.76	26	22	0.12	0.38	0.71	1.37	85990702JJ	M39029/58-360	Black/Blue/Orange
	Socket								85990710900	M39029/57-354	Yellow/Green/Orange
#20	Pin	1.00	24	20	0.21	0.60	1.02	2.11	85990703SA	M39029/58-363	Orange/Blue/Orange
	Socket								85990711900	M39029/57-357	Purple/Green/Orange
#16	Pin	1.60	20	16	0.60	1.34	1.65	2.77	85990704MJ	M39029/58-364	Yellow/Blue/Orange
	Socket								85990712900	M39029/57-358	Grey/Green/Orange
#12	Pin	2.40	14	12	1.91	3.18	2.46	3.61	85990705MJ	M39029/58-365	Green/Blue/Orange
	Socket								85990713900	M39029/57-359	White/Green/Orange

Straight PC tail contacts

Contact size	Contact type	Contact length	Part number
#22D	Pin	L: Long PC tail	85990720900
		C: Short PC tail	85990730900
#20	Pin	L: Long PC tail	85990771900
		C: Short PC tail	85990724900
#16	Pin	L: Long PC tail	85997496A900
		C: Short PC tail	85990726900
#12	Pin	C: Short PC tail	85997711900

Filler plugs

Contact size	MS Part number (Rev. N)	Color	SOURIAU Part number	Color
#22D	MS27488-22-2	Black	8660-212	Black
#20	MS27488-20-2	Red	8522-389A	Red
#16	MS27488-16-2	Green	8522-390A	Blue
#12	MS27488-12-2	Orange	8522-391A	Yellow

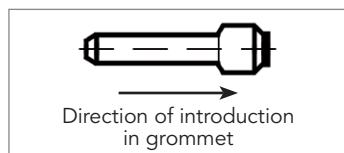

These filler plugs are installed at the rear of unwired contact to maintain connector sealing.

Tooling

Insertion and extraction tools

Contact size	Material	Part number MIL standard	Color	
			Insertion	Extraction
#22D	Plastic	M81969/14-01	Green	White
#20	Plastic	M81969/14-10	Red	Orange
#16	Plastic	M81969/14-03	Blue	White
#12	Plastic	M81969/14-04	Yellow	White

Crimping tools

Contact size	Contact type	Wire sizes		Plier M22520/1-01	Plier M22520/2-01 (SOURIAU 8476-01)
		mm ²	AWG	Turret Part number	Locator Part number
#22D	Pin	0.38 0.21	22 24	-	M22520/2-09
	Socket	0.15 0.095	26 28		M22520/2-06
#20	Pin	0.60 0.38	20 22	M22520/1-04	M22520/2-10
	Socket	0.21	24		
#16	Pin	1.34 0.93	16 18	M22520/1-04	-
	Socket	0.60	20		
#12	Pin	3.18	14	M22520/1-04	-
	Socket	1.91	12		

Backshell tightening tools

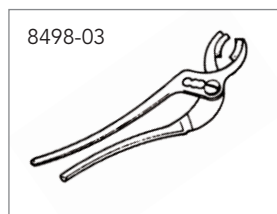

Backshell tightening pliers, part number: 8498-03
Square jaws (order 2 jaws), part number: 8500-1015

Tightening support

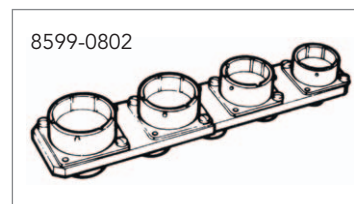

Part number: 8599-0802
This tool is made up of dummy receptacles housings of all 9 sizes for all key polarisation, and secures free connectors during wiring and fitting of rear accessories.

Tightening of rear accessories:

Shell size	8	10	12	14	16	18	20	22	24
Max torque in m/daN	0.62						1.24		

Slackening tools

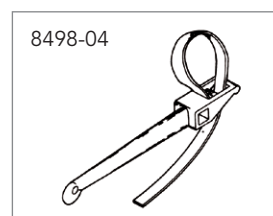

Strap clamp, part number: 8498-04
Spare strap, part number: 8498-103

Wiring instruction

Cable preparation and wire stripping

Contact size	#22D	#20	#16	#12
L	4	6		

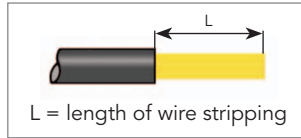

Insertion of wire in contact barrel

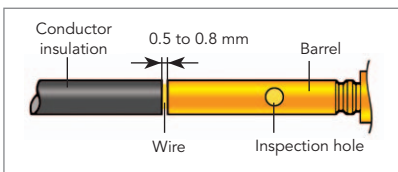

When inserting the stripped wire into the contact barrel check that no strands are left outside and that the wire is visible through the wire inspection hole.

Important:

- Slide any accessories over wire strands before carrying out the following operations.
- Contacts are inserted and extracted from the rear of the connector.

Insertion of the contacts

1 - Engage the crimp cable / contact assembly into the longitudinal slot of the plastic tool (coloured tip). Slide the tool down the cable until the tip of the tool abuts the contact retention shoulder.

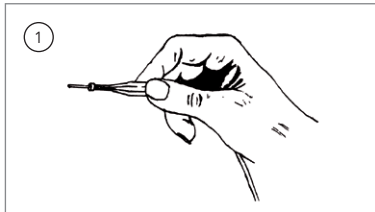

2 - Introduce the contact into the required contact cavity in the insulator, pushing tool axially, until the contact snaps into position in clip.

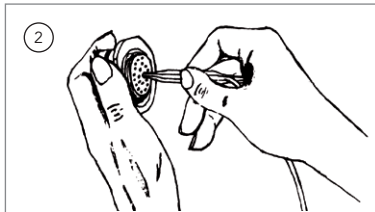

3 - Withdraw the tool from rear. Check that contact is firmly locked by pulling wire gently. When connector is fully loaded, check the position of contact tips. They should all be in the same plane.
Nota: For larger sizes of cable which are stiff enough manual insertion without tool is preferable.

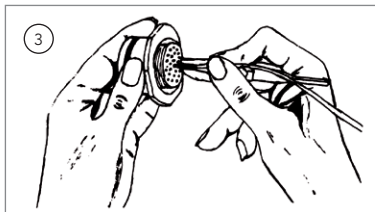

Extraction of the contacts

1 - Engage the appropriate cable into the longitudinal slot of the tool with the white tip towards connector.

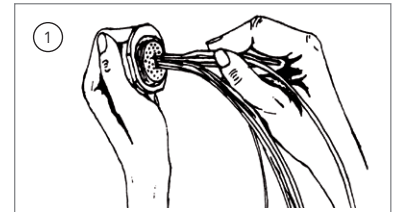

2 - Slide the tool down towards the contact. Insert the tool in the insulator until it abuts the contact shoulder.

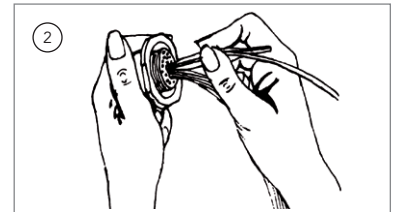

3 - Holding the tool-contact and cable assembly together, remove them simultaneously.

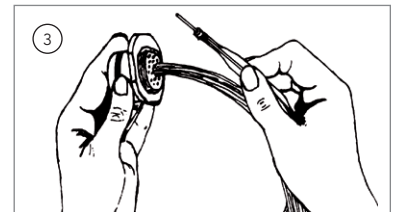

Gaskets

Shell size	Part Numbers	
	For receptacle Type 0	For receptacle Type 7
08	8525 1431	AS3582-022
10	8525 1432	AS3582-024
12	8525 1433	AS3582-026
14	8525 1434	AS3582-028
16	8525 1435	AS3582-029

Shell size	Part Numbers	
	For receptacle Type 0	For receptacle Type 7
18	8525 1436	AS3582-030
20	8525 1437	AS3582-031
22	8525 1438	AS3582-032
24	8525 1439	AS3582-033

Orientations

Polarization is determined by the master keyway position. The secondary keyway positions remain fixed.

Shell size	Angles (degrees)				
	N	A	B	C	D
08	100	82	-	-	118
10	100	86	72	128	114
12	100	80	68	132	120
14	100	79	66	134	121
16	100	82	70	130	118
18	100	82	70	130	118
20	100	82	70	130	118
22	100	85	74	126	115
24	100	85	74	126	115

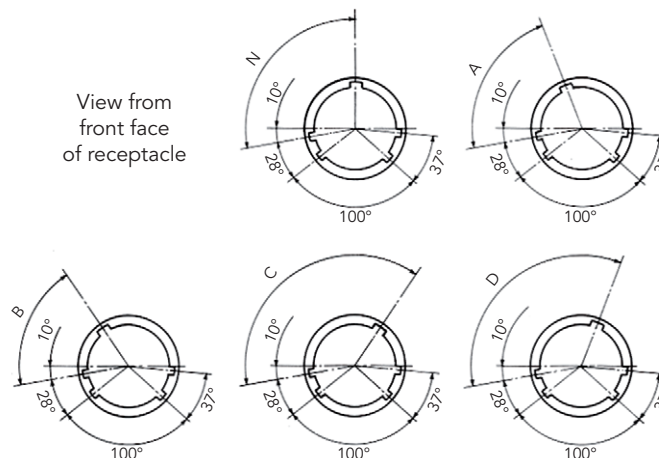

Dummy receptacles

Shell size	A	B		C	D		Part Numbers	
		Min.	Max.		Min.	Max.	Olive green cadmium plating	Nickel plating
08	13.24	20.57	21.10	15.09	3.08	3.30	8T3-08GUR	8T3-08FUR
10	16.19	23.78	24.31	18.26	3.08	3.30	8T3-10GUR	8T3-10FUR
12	20.48	26.16	26.69	20.62	3.08	3.30	8T3-12GUR	8T3-12FUR
14	23.70	28.55	29.08	23.01	3.08	3.30	8T3-14GUR	8T3-14FUR
16	26.84	30.91	31.71	24.61	3.08	3.30	8T3-16GUR	8T3-16FUR
18	30.00	33.27	34.10	26.97	3.08	3.30	8T3-18GUR	8T3-18FUR
20	33.18	36.47	37.28	29.36	3.08	3.30	8T3-20GUR	8T3-20FUR
22	36.35	39.65	40.45	31.75	3.08	3.30	8T3-22GUR	8T3-22FUR
24	39.55	42.82	43.63	34.93	3.71	3.99	8T3-24GUR	8T3-24FUR

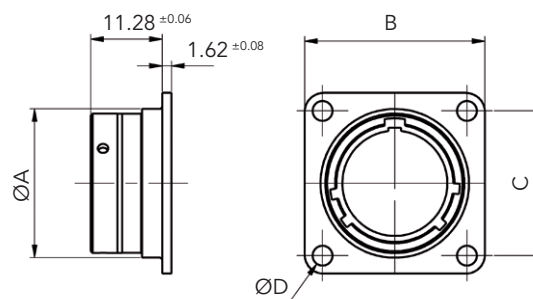

Note: All dimensions are in millimeters (mm)

Backshells assembly

Band lock Type 05

Step 1: Prepare cable braid

Terminate wires to connector and screw the backshell to connector. Prepare the cable for termination process.

WARNING ! Banding must occur on an un-fixed cable assembly. Attaching a band to a firmly clamped cable will affect the applied forces and will also interfere with the cut-off operation. The cut-off operation causes a rotation of the band termination in order to lock the band.

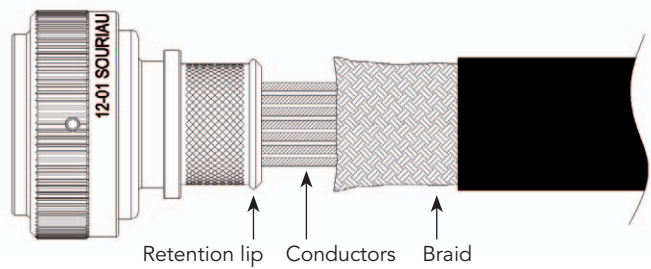

Step 2: Push braid over adaptor

Push the braid over the retention lip to the adaptor incline point or ensuring 10.2mm [0.4"] minimum braid length over termination area. Milk the braid as required to remove the slack and insure a snug fit around the shield termination area.

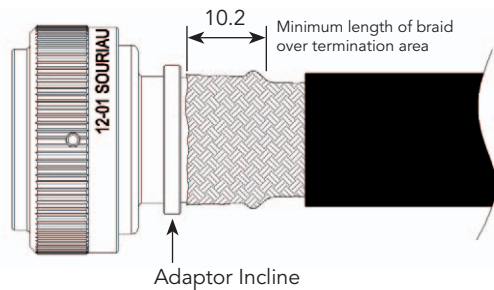

Step 3: Prepare band

Roll the band through the buckle slot twice. Pull on the band until the tail length indicator mark is within approximately 6.4 mm (0.250 in) of the buckle slot. The band may be tightened further if desired.

WARNING ! Always roll band through the buckle slot twice in order to ensure correct functioning.

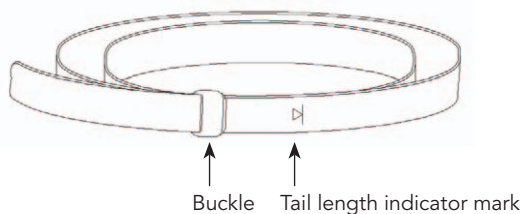

Note: All dimensions are in millimeters (mm)

Step 4: Install band

a) Squeeze the gripper release lever of the banding tool and insert the band into the front end opening of the tool as shown on picture. **WARNING !** The circular portion of looped band must always face downward.



b) Aligning the band and the tool with the shield termination area, squeeze the black pull-up handle repeatedly using short strokes until it locks against the tool body (this indicates that the band is compressed to the tool pre-calibrated tension).

IMPORTANT ! Operator technique can affect the integrity of the band installation. The operator should use **abbreviated** or **partial** strokes of the pull-up handle as the band is pulling up against the braid. As the band becomes completely tight, apply a full strokes of the pull-up handle to ensure that the full calibrated force of the tool is applied as the handle locks into position.

c) Complete the clamping process by squeezing the gray cut-off handle, allowing the cable to rotate slightly during cut-off.

Step 5: Inspect the shield termination

Remove the excess band from the tool. Inspect shield termination. Install the heat shrinkable boot, if required.

WARNING ! Tools and Bands should never be lubricated.

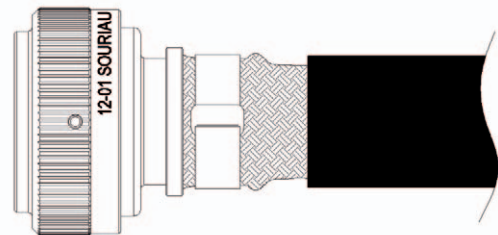

Double cone Type 06

Step 1: Prepare cable braid

Prepare the cable for termination process and slide the backshell parts onto the cable the items in the order shown in above figure. Screw the backshell at the rear of the connector.

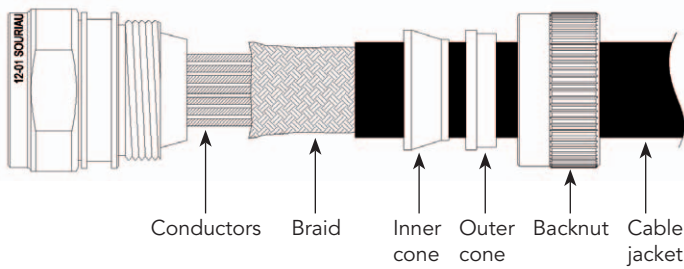

Step 2: Push braid over adaptor

Release the braid and slide the inner cone over the braid.

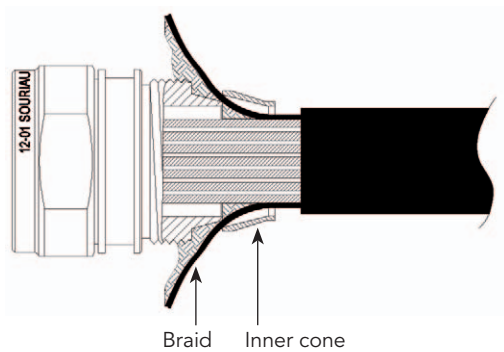

Step 3-a: Double folding

Fold back the braid on the inner cone and fix it with an adhesive tape on to the jacket of the cable. Slide the outer cone over the braid and the inner cone. Screw the backnut at the rear of the backshell and tighten it. Install heat shrinkable boot.

Please refer to Step 3-b for alternate method (Single folding).

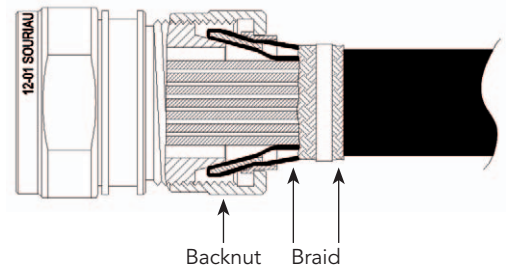

Step 3-b: Single folding

Cut the braid as shown. Slide the outer cone over the braid and the inner cone. Screw the backnut at the rear of the backshell and tighten it. Install heat-shrinkable boot.

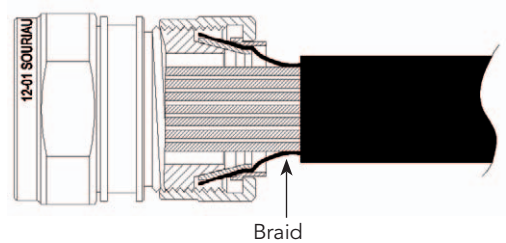

Band-it

Designation	Flat stainless steel standard band	Pre-coiled stainless steel standard band	Hand banding tool
Part number	8599-9344	8599-9345	8599-9346

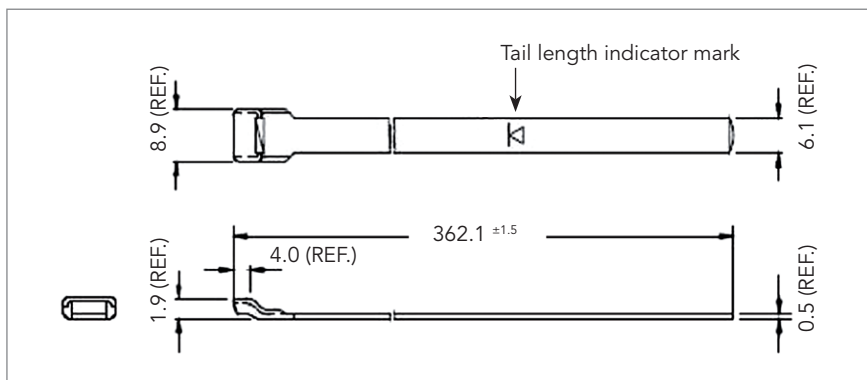

Note: All dimensions are in millimeters (mm)

Coordinates for straight PC tail terminations Viewed from front face of male insulator

Hole sizes: 1mm min. (#22 and #20 contacts) and 1.3mm min. (#16 contact) coordinates in mm.

08

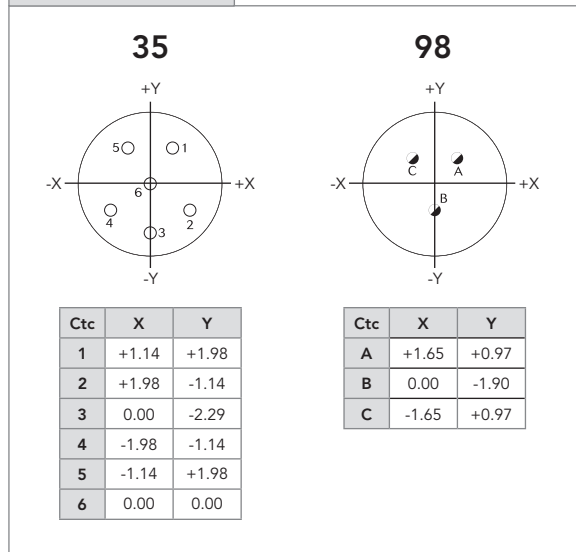

10

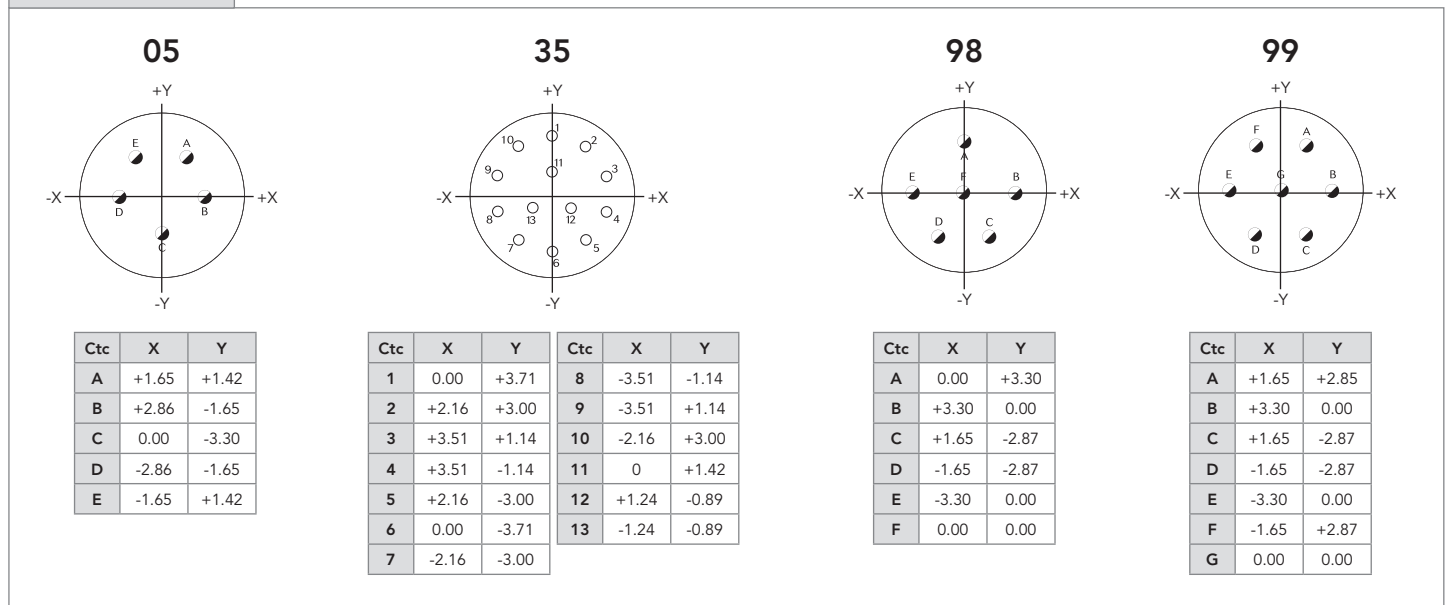

12

04

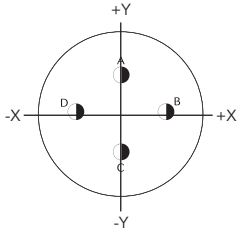

Ctc	X	Y
A	0.00	+3.81
B	+3.71	+0.89
C	0.00	-2.11
D	-3.71	+0.89

08

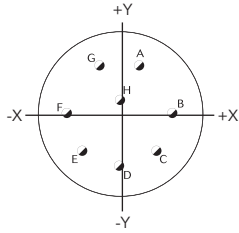

Ctc	X	Y
A	+1.65	+3.99
B	+4.32	0.00
C	+3.05	-3.05
D	0.00	-4.32
E	-3.05	-3.05
F	-4.32	0.00
G	-1.65	+3.99
H	0.00	+1.12

35

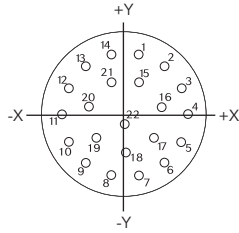

Ctc	X	Y
1	+1.14	+5.00
2	+3.20	+4.01
3	+4.62	+2.24
4	+5.16	0.00
5	+4.62	-2.24
6	+3.20	-4.01
7	+1.14	-5.00
8	-1.14	-5.00
9	-3.20	-4.01
10	-4.62	-2.24
11	-5.16	0.00
12	-4.62	+2.24
13	-3.20	+4.01
14	-1.14	+5.00
15	+1.14	+2.72
16	+2.97	+0.66
17	+2.36	-1.91
18	0.00	-3.05
19	-2.36	-1.91
20	-2.97	+0.66
21	-1.24	+2.72
22	0.00	-0.76

98

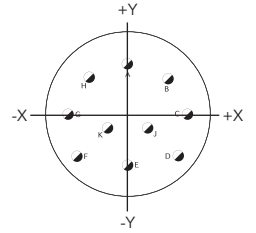

Ctc	X	Y
A	0.00	+4.95
B	+3.18	+3.81
C	+4.90	+0.76
D	+4.17	-2.67
E	0.00	-3.43
F	-4.17	-2.67
G	-4.90	+0.76
H	-3.18	+3.81
J	+1.65	-0.38
K	-1.65	-0.38

14

05

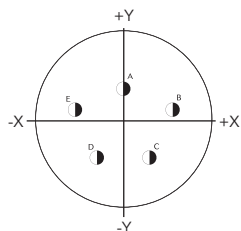

Ctc	X	Y
A	0	+2.54
B	+4.42	+0.61
C	+2.39	+3.76
D	-2.39	-3.76
E	-4.42	+0.61

18

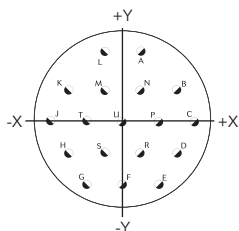

Ctc	X	Y
A	+1.65	+6.40
B	+4.95	+2.87
C	+6.60	0.00
D	+4.95	-2.87
E	+3.30	-5.72
F	0.00	-5.72
G	-3.30	-5.72
H	-4.95	-2.87
J	-6.60	0.00
K	-4.95	+2.87
L	-1.65	+6.40
M	-1.65	+2.87
N	+1.65	+2.87
P	+3.30	0.00
R	+1.65	-2.87
S	-1.65	-2.87
T	-3.30	0.00
U	0.00	0.00

19

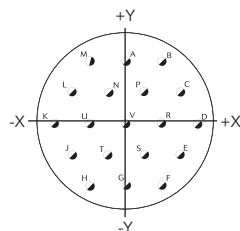

Ctc	X	Y
A	0.00	+5.72
B	+3.30	+5.72
C	+4.95	+2.87
D	+6.60	0.00
E	+4.95	-2.87
F	+3.30	-5.72
G	0.00	-5.72
H	-3.30	-5.72
J	-4.95	-2.87
K	-6.60	0.00
L	-4.95	+2.87
M	-3.30	+5.72
N	-1.65	+2.87
P	+1.65	+2.87
R	+3.30	0.00
S	+1.65	-2.87
T	-1.65	-2.87
U	-3.30	0.00
V	0.00	0.00

97

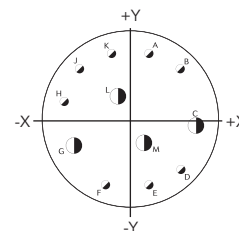

Ctc	X	Y
A	+1.65	+5.94
B	+4.52	+4.52
C	+5.84	-0.58
D	+4.52	-4.52
E	+1.65	-5.94
F	-2.26	-5.97
G	-5.26	-2.41
H	-5.94	+1.65
J	-4.52	+4.52
K	-1.65	+5.94
L	-1.19	+2.06
M	+1.19	-2.06

35

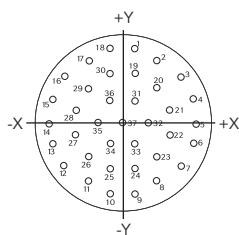

Ctc	X	Y	Ctc	X	Y	Ctc	X	Y	Ctc	X	Y	Ctc	X	Y
1	+1.14	+6.65	9	+1.14	-6.65	17	-3.12	+5.51	24	+1.14	-4.37	31	+1.14	+1.88
2	+3.12	+5.51	10	-1.14	-6.65	18	-1.14	+6.65	25	-1.14	-4.37	32	+2.29	-0.10
3	+5.36	+4.06	11	-3.30	-5.89	19	+1.14	+4.37	26	-3.12	-3.23	33	+1.14	-2.08
4	+6.45	+2.03	12	-5.08	-4.45	20	+3.12	+3.02	27	-4.32	-1.27	34	-1.14	-2.08
5	+6.76	-0.25	13	-6.27	-2.49	21	+4.32	+1.02	28	-4.32	+1.02	35	-2.29	-0.10
6	+6.27	-2.49	14	-6.76	-0.25	22	+4.32	-1.27	29	-3.12	+3.02	36	-1.14	+1.88
7	+5.08	-4.45	15	-6.45	+2.03	23	+3.12	-3.23	30	-1.14	+4.37	37	0.00	-0.10
8	+3.30	-5.89	16	-5.36	+4.06									

16

06

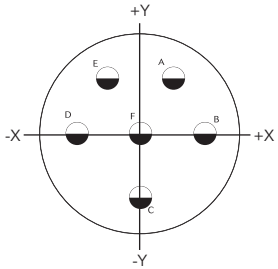

Ctc	X	Y
A	+3.07	+5.31
B	+6.12	0.00
C	0.00	-6.12
D	-6.12	0.00
E	-3.07	+5.31
F	0.00	0.00

08

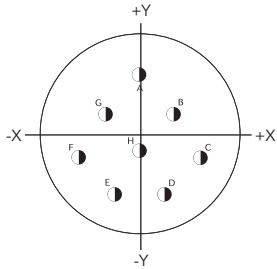

Ctc	X	Y
A	0.00	+5.99
B	+3.25	+2.18
C	+5.84	-1.98
D	+2.39	-5.49
E	-2.39	-5.49
F	-5.84	-1.98
G	-3.25	+2.18
H	0.00	-1.32

26

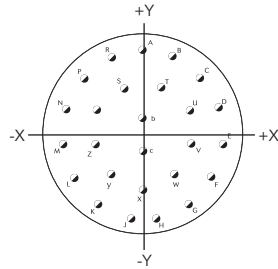

Ctc	X	Y
A	0.00	+8.15
B	+3.33	+7.44
C	+6.07	+5.44
D	+7.75	+2.51
E	+8.10	-0.86
F	+7.06	-4.09
G	+4.80	-6.60
H	+1.70	-7.98
J	-1.70	-7.98
K	-4.80	-6.60
L	-7.06	-4.09
M	-8.10	-0.86
N	-7.75	+2.51
P	-6.07	+5.44
R	-3.33	+7.44
S	-1.78	+4.50
T	+1.78	+4.50
U	+4.45	+2.39
V	+4.53	-0.91
W	+3.02	-3.84
X	0.00	-5.16
Y	-3.02	-3.84
Z	-4.53	-0.91
a	-4.45	+2.39
b	0.00	+1.65
c	0.00	-1.65

99

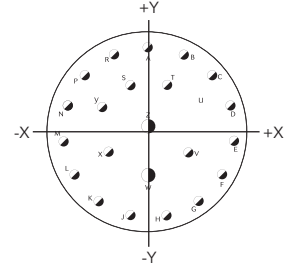

Ctc	X	Y
A	0.00	+8.15
B	+3.33	+7.44
C	+6.07	+5.44
D	+7.75	+2.51
E	+8.10	-0.86
F	+7.06	-4.09
G	+4.80	-6.60
H	+1.70	-7.98
J	-1.70	-7.98
K	-4.80	-6.60
L	-7.06	-4.09
M	-8.10	-0.86
N	-7.75	+2.51
P	-6.07	+5.44
R	-3.33	+7.44
S	-1.78	+4.50
T	+1.78	+4.50
U	+4.45	+2.39
V	+3.81	-1.91
W	0.00	-4.09
X	-3.81	-1.91
Y	-4.45	+2.39
Z	0.00	+0.64

35

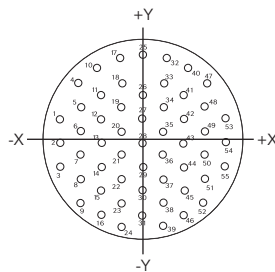

Ctc	X	Y
1	-7.92	+2.18
2	-7.92	-0.10
3	-7.92	-2.39
4	-6.15	+5.61
5	-5.94	+3.33
6	-5.94	+1.04
7	-5.94	-1.24
8	-5.94	-3.53
9	-5.94	-5.82
10	-4.37	+7.09
11	-3.96	+4.47
12	-3.96	+2.18
13	-3.96	-0.10
14	-3.96	-2.39
15	-3.96	-4.67
16	-3.96	-6.96
17	-2.26	+8.03
18	-1.98	+5.61
19	-1.98	+3.33
20	-1.98	+1.04
21	-1.98	-1.24
22	-1.98	-3.53
23	-1.98	-5.82
24	-1.98	-8.10
25	0.00	+8.36
26	0.00	+4.47
27	0.00	+2.18
28	0.00	-0.10
29	0.00	-2.39
30	0.00	+4.67
31	0.00	-6.96
32	+2.26	+8.03
33	+1.98	+5.61
34	+1.98	+3.33
35	+1.98	+1.04
36	+1.98	-1.24
37	+1.98	-3.53
38	+1.98	-5.82
39	+1.98	-8.10
40	+4.37	+7.09
41	+3.96	+4.47
42	+3.96	+2.18
43	+3.96	-0.10
44	+3.96	-2.39
45	+3.96	-4.67
46	+3.96	-6.96
47	+6.15	+5.61
48	+5.94	+3.33
49	+5.94	+1.04
50	+5.94	-1.24
51	+5.94	-3.53
52	+5.94	-5.82
53	+7.92	+2.18
54	+7.92	-0.10
55	+7.92	-2.39

18

11

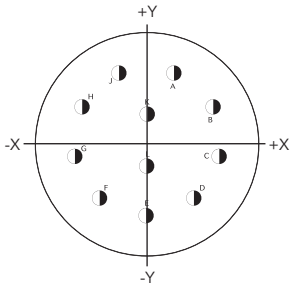

Ctc	X	Y
A	+2.67	+6.60
B	+6.35	+3.35
C	+6.99	-1.35
D	+4.55	-5.46
E	0.00	-7.14
F	-4.55	-5.46
G	-6.99	-1.35
H	-6.35	+3.35
J	-2.67	+6.60
K	0.00	+2.67
L	0.00	-2.34

32

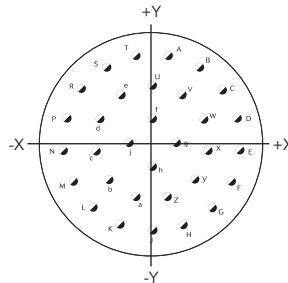

Ctc	X	Y
A	+1.68	+8.97
B	+4.80	+7.75
C	+7.26	+5.51
D	+8.76	+2.49
E	+9.07	-0.84
F	+8.15	-4.06
G	+6.15	-6.73
H	+3.30	-8.51
J	0.00	-9.12
K	-3.30	-8.51
L	-6.15	-6.73
M	-8.15	-4.06
N	-9.07	-0.84
P	-8.76	+2.49
R	-7.26	+5.51
S	-4.80	+7.75

Ctc	X	Y
T	-1.68	+8.97
U	0.00	+5.84
V	+3.15	+4.90
W	+5.31	+2.41
X	+5.79	-0.84
Y	+4.42	-3.84
Z	+1.65	-5.61
a	-1.65	-5.61
b	-4.42	-3.84
c	-5.79	-0.84
d	-5.31	+2.41
e	-3.15	+4.90
f	0.00	+2.44
g	+2.44	0.00
h	0.00	-2.44
j	-2.44	0.00

35

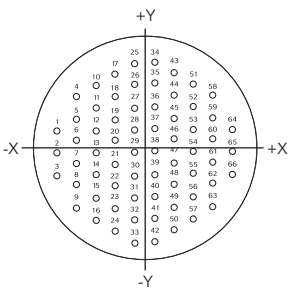

Ctc	X	Y
1	-9.07	+2.29
2	-9.07	0.00
3	-9.07	-2.29
4	-7.09	+5.71
5	-7.09	+3.43
6	-7.09	+1.14
7	-7.09	-1.14
8	-7.09	-3.43
9	-7.09	-5.71
10	-5.11	+6.86
11	-5.11	+4.57
12	-5.11	+2.29
13	-5.11	0.00
14	-5.11	-2.29

Ctc	X	Y
15	-5.11	-4.57
16	-5.11	-6.86
17	-3.12	+8.00
18	-3.12	+5.71
19	-3.12	+3.43
20	-3.12	+1.14
21	-3.12	-1.14
22	-3.12	-3.43
23	-3.12	-5.71
24	-3.12	-8.00
25	-1.14	+9.14
26	-1.14	+6.86
27	-1.14	+4.57

Ctc	X	Y
28	-1.14	+2.29
29	-1.14	0.00
30	-1.14	-2.29
31	-1.14	-4.57
32	-1.14	-6.86
33	-1.14	-9.14
34	+1.14	+9.14
35	+1.14	+6.86
36	+1.14	+4.57
37	+1.14	+2.29
38	+1.14	0.00
39	+1.14	-2.29
40	+1.14	-4.57

Ctc	X	Y
41	+1.14	-6.86
42	+1.14	-9.14
43	+3.12	+8.00
44	+3.12	+5.71
45	+3.12	+3.43
46	+3.12	+1.14
47	+3.12	-1.14
48	+3.12	-3.43
49	+3.12	-5.71
50	+3.12	-8.00
51	+5.11	+6.86
52	+5.11	+4.57
53	+5.11	+2.29

Ctc	X	Y
54	+5.11	0.00
55	+5.11	-2.29
56	+5.11	-4.57
57	+5.11	-6.86
58	+7.09	+5.71
59	+7.09	+3.43
60	+7.09	+1.14
61	+7.09	-1.14
62	+7.09	-3.43
63	+7.09	-5.71
64	+9.07	+2.29
65	+9.07	0.00
66	+9.07	-2.29

16

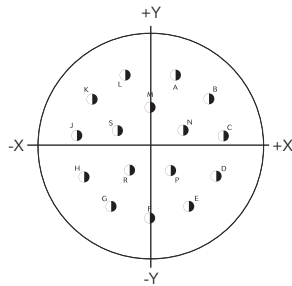

Ctc	X	Y	Ctc	X	Y
A	+3.00	+8.18	J	-8.66	+0.91
B	+6.88	+5.36	K	-6.88	+5.36
C	+8.66	+0.91	L	-3.00	+8.18
D	+7.82	-3.81	M	0.00	+4.45
E	+4.62	-7.37	N	+3.91	+1.57
F	0.00	-8.71	P	+2.39	-3.10
G	-4.62	-7.37	R	-2.39	-3.10
H	-7.82	-3.81	S	-3.91	+1.57

35

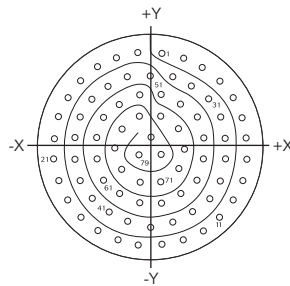

Ctc	X	Y	Ctc	X	Y
1	+1.35	+10.82	23	-10.31	+3.58
2	+3.71	+10.26	24	-9.27	+5.77
3	+5.89	+9.19	25	-7.77	+7.67
4	+7.77	+7.67	26	-5.89	+9.19
5	+9.27	+5.77	27	-3.71	+10.26
6	+10.31	+3.58	28	-1.35	+10.82
7	+10.85	+1.22	29	0.00	+8.20
8	+10.85	-1.22	30	+2.49	+8.18
9	+10.31	-3.58	31	+4.67	+7.11
10	+9.27	-5.77	32	+6.55	+5.59
11	+7.77	-7.67	33	+7.90	+3.58
12	+5.89	-9.19	34	+8.43	+1.22
13	+3.71	-10.26	35	+8.43	-1.22

Ctc	X	Y	Ctc	X	Y
14	+1.35	-10.82	36	+7.90	-3.58
15	-1.35	-10.82	37	+6.55	-5.59
16	-3.71	-10.26	38	+4.67	-7.11
17	-5.89	-9.19	39	+2.49	-8.18
18	-7.77	-7.67	40	0.00	-8.81
19	-9.27	-5.77	41	-2.49	-8.18
20	-10.31	-3.58	42	-4.67	-7.11
21	-10.85	-1.22	43	-6.55	-5.59
22	-10.85	+1.22	44	-7.90	-3.58
23	-10.31	+3.58	45	-8.43	-1.22
24	-9.27	+5.77	46	-8.43	+1.22
25	-7.77	+7.67	47	-7.90	+3.58
26	-5.89	+9.19	48	-6.55	+5.59
27	-3.71	+10.26	49	-4.67	+7.11
28	-1.35	+10.82	50	-2.49	+8.18
29	0.00	+8.20	51	-1.22	+6.12
30	+2.49	+8.18	52	+1.22	+6.12
31	+4.67	+7.11	53	+3.40	+5.05
32	+6.55	+5.59	54	+5.28	+3.53
33	+7.90	+3.58	55	+6.02	+1.22
34	+8.43	+1.22	56	+6.02	-1.22
35	+8.43	-1.22	57	+5.28	-3.53

Ctc	X	Y	Ctc	X	Y
58	+3.40	-5.05	66	-3.40	+5.05
59	+1.22	-6.12	67	-1.22	+3.71
60	-1.22	-6.12	68	+1.22	+3.71
61	-3.40	-5.05	69	+3.18	+2.29
62	-5.28	-3.53	70	+3.94	0.00
63	-6.02	-1.22	71	+3.18	-2.29
64	-6.02	+1.22	72	+1.22	-3.71
65	-5.28	+3.53	73	-1.22	-3.71
66	-3.40	+5.05	74	-3.18	-2.29
67	-1.22	+3.71	75	-3.94	0.00
68	+1.22	+3.71	76	-3.18	+2.29
69	+3.18	+2.29	77	0.00	+1.35
70	+3.94	0.00	78	+1.22	-0.74
71	+3.18	-2.29	79	-1.22	-0.74
72	+1.22	-3.71			
73	-1.22	-3.71			
74	-3.18	-2.29			
75	-3.94	0.00			
76	-3.18	+2.29			
77	0.00	+1.35			
78	+1.22	-0.74			
79	-1.22	-0.74			

39

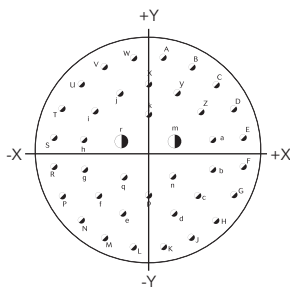

Ctc	X	Y	Ctc	X	Y	Ctc	X	Y
A	+1.65	+10.44	P	-9.42	-4.80	d	+2.84	-6.73
B	+4.80	+9.42	R	-10.44	-1.65	e	-2.84	-6.73
C	+7.47	+7.47	S	-10.44	+1.65	f	-5.51	-4.80
D	+9.42	+4.80	T	-9.42	+4.80	g	-7.11	-1.88
E	+10.44	+1.65	U	-7.47	+7.47	h	-7.11	+1.45
F	+10.44	-1.65	V	-4.80	+9.42	i	-5.89	+4.55
G	+9.42	-4.80	W	-1.65	+10.44	j	-3.20	+6.50
H	+7.47	-7.47	X	0.00	+7.49	k	0.00	+4.17
J	+4.80	-9.42	Y	+3.20	+6.50	m	+2.90	+1.22
K	+1.65	-10.44	Z	+5.89	+4.55	n	+2.69	-2.72
L	-1.65	-10.44	a	+7.11	+1.45	p	0.00	-4.80
M	-4.80	-9.42	b	+7.11	-1.88	q	-2.69	-2.72
N	-7.47	-7.47	c	+5.51	-4.80	r	-2.90	+1.22

41

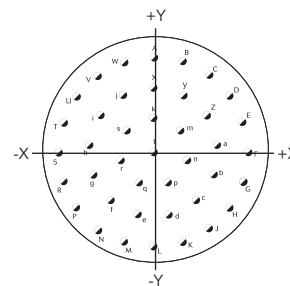

Ctc	X	Y	Ctc	X	Y
A	0.00	+10.60	M	-3.26	-10.09
B	+3.28	+10.09	N	-6.23	-8.58
C	+6.23	+8.58	P	-8.58	-6.23
D	+8.58	+6.23	R	-10.09	-3.28
E	+10.09	+3.28	S	-10.60	0.00
F	+10.60	0.00	T	-10.09	+3.28
G	+10.09	-3.28	U	-8.58	+6.23
H	+8.58	-6.23	V	-6.23	+8.58
J	+6.23	-8.58	W	-3.28	+10.09
K	+3.28	-10.09	X	0.00	+7.20
L	0.00	-10.60	Y	+3.35	+6.38

Ctc	X	Y
Z	+5.92	+4.09
a	+7.15	+0.87
b	+6.73	-2.55
c	+4.78	-5.39
d	+1.73	-6.99
e	-1.73	-6.99
f	-4.78	-5.39
g	-6.73	-2.55
h	-7.15	+0.87
i	-5.92	+4.09
j	-3.35	+6.38
k	0.00	+3.81
m	+2.98	+2.38
n	+3.71	-0.85
p	+1.66	-3.43
q	-1.66	-3.43
r	-3.71	-0.85
s	-2.98	+2.38
t	0.00	0.00

22

21

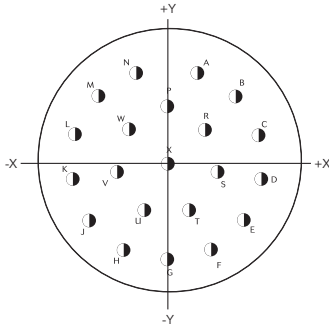

Ctc	X	Y
A	+3.25	+9.78
B	+7.34	+7.24
C	+9.80	+3.12
D	+10.16	-1.65
E	+8.33	-6.07
F	+4.65	-9.19
G	0.00	-10.31
H	-4.65	-9.19
J	-8.33	-6.07
K	-10.16	-1.65
L	-9.80	+3.12
M	-7.34	+7.24
N	-3.25	+9.78
P	0.00	+6.22
R	+4.06	+3.71
S	+5.44	-0.89
T	+2.39	-4.93
U	-2.39	-4.93
V	-5.44	-0.89
W	-4.06	+3.71
X	0.00	0.00

53

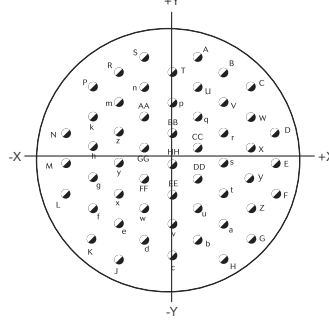

Ctc	X	Y
N	-11.43	+3.30
P	-8.53	+8.26
R	-5.72	+9.91
S	-2.84	+11.56
T	0.00	+9.91
U	+2.84	+8.26
V	+5.72	+6.60
W	+8.53	+4.95
X	+8.53	+1.65
Y	+8.53	-1.65
Z	+8.53	-4.95
a	+5.72	-6.60
b	+2.84	-8.26
c	0.00	-9.91
d	-2.84	-8.26
e	-5.72	-6.60
f	-8.53	-4.95
g	-8.53	-1.65
h	-8.53	+1.65
k	-8.53	+4.95

Ctc	X	Y
m	-5.72	+6.60
n	-2.84	+8.26
p	0.00	+6.60
q	+2.84	+4.95
r	+5.72	+3.30
s	+5.72	0.00
t	+5.72	-3.30
u	+2.84	-4.95
v	0.00	-6.60
w	-2.84	-4.95
x	-5.72	-3.30
y	-5.72	0.00
z	-5.72	+3.30
AA	-2.84	+4.95
BB	0.00	+3.30
CC	+2.84	+1.65
DD	+2.84	-1.65
EE	0.00	-3.30
FF	-2.84	-1.65
GG	-2.84	+1.65
HH	0.00	0.00

Ctc	X	Y
A	+2.84	+11.56
B	+5.72	+9.91
C	+8.53	+8.26
D	+11.43	+3.30
E	+11.43	0.00
F	+11.43	-3.30

Ctc	X	Y
G	+8.53	-8.26
H	+5.72	-10.41
J	-5.72	-10.41
K	-8.53	-8.26
L	-11.43	-3.30
M	-11.43	0.00

35

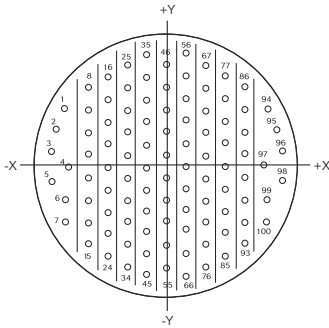

Ctc	X	Y
1	-10.87	+6.12
2	-11.86	+3.91
3	-12.40	+1.55
4	-10.54	0.00
5	-12.40	-1.55
6	-10.87	-3.61
7	-10.87	-6.02
8	-8.43	+8.46
9	-8.43	+6.05
10	-8.43	+3.63
11	-8.43	+1.22
12	-8.43	-1.19
13	-8.43	-3.61
14	-8.43	-6.02
15	-8.43	-8.43
16	-6.32	+9.65
17	-6.32	+7.24
18	-6.32	+4.83
19	-6.32	+2.41
20	-6.32	0.00

Ctc	X	Y
21	-6.32	-2.41
22	-6.32	-4.83
23	-6.32	-7.24
24	-6.32	-9.65
25	-4.22	+10.87
26	-4.22	+8.46
27	-4.22	+6.05
28	-4.22	+3.63
29	-4.22	+1.22
30	-4.22	-1.19
31	-4.22	-3.61
32	-4.22	-6.02
33	-4.22	-8.43
34	-4.22	-10.85
35	-2.11	+12.07
36	-2.11	+9.65
37	-2.11	+7.24
38	-2.11	+4.83
39	-2.11	+2.41
40	-2.11	0.00

Ctc	X	Y
41	-2.11	-2.41
42	-2.11	-4.83
43	-2.11	-7.24
44	-2.11	-9.65
45	-2.11	-12.07
46	0.00	+10.87
47	0.00	+8.46
48	0.00	+6.05
49	0.00	+3.63
50	0.00	+1.22
51	0.00	-1.19
52	0.00	-3.61
53	0.00	-6.02
54	0.00	-8.43
55	0.00	-10.85
56	+2.11	+12.07
57	+2.11	+9.65
58	+2.11	+7.24
59	+2.11	+4.83
60	+2.11	+2.41

Ctc	X	Y
61	+2.11	0.00
62	+2.11	-2.41
63	+2.11	-4.83
64	+2.11	-7.24
65	+2.11	-9.65
66	+2.11	-12.07
67	+4.22	+10.87
68	+4.22	+8.46
69	+4.22	+6.05
70	+4.22	+3.63
71	+4.22	+1.22
72	+4.22	-1.19
73	+4.22	-3.61
74	+4.22	-6.02
75	+4.22	-8.43
76	+4.22	-10.85
77	+6.32	+9.65
78	+6.32	+7.24
79	+6.32	+4.83
80	+6.32	+2.41

Ctc	X	Y
81	+6.32	0.00
82	+6.32	-2.41
83	+6.32	-4.83
84	+6.32	-7.24
85	+6.32	-9.65
86	+8.43	+8.46
87	+8.43	+6.05
88	+8.43	+3.63
89	+8.43	+1.22
90	+8.43	-1.19
91	+8.43	-3.61
92	+8.43	-6.02
93	+8.43	-8.43
94	+10.87	+6.12
95	+11.86	+3.91
96	+12.40	+1.55
97	+10.54	0.00
98	+12.40	-1.55
99	+10.87	-3.61
100	+10.87	-6.02

04

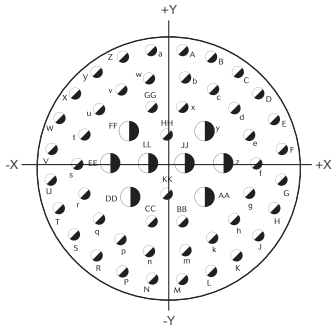

Ctc	X	Y
A	+1.75	+13.49
B	+5.16	+12.57
C	+8.23	+10.80
D	+10.77	+8.28
E	+12.52	+5.21
F	+13.49	+1.75
G	+13.49	-1.75

Ctc	X	Y
H	+12.52	-5.21
J	+10.77	-8.28
K	+8.23	-10.80
L	+5.16	-12.57
M	+1.75	-13.49
N	-1.75	-13.49
P	-5.16	-12.57

Ctc	X	Y
R	-8.23	-10.80
S	-10.77	-8.28
T	-12.52	-5.21
U	-13.49	-1.75
V	-13.49	+1.75
W	-12.52	+5.21
X	-10.77	+8.28
Y	-8.23	+10.80
Z	-5.16	+12.57
a	-1.75	+13.49
b	+2.18	+10.08
c	+5.38	+8.78
d	+7.90	+6.38
e	+9.58	+3.35
f	+10.46	0.00
g	+9.58	-3.35
h	+7.90	-6.38
k	+5.38	-8.78
m	+2.18	-10.08
n	-2.18	-10.08
p	-5.38	-8.78

Ctc	X	Y
q	-7.90	-6.38
r	-9.58	-3.35
s	-10.46	0.00
t	-9.58	+3.35
u	-7.90	+6.38
v	-5.38	+8.78
w	-2.18	+10.08
x	+1.75	+6.66
y	+4.37	+3.78
z	+6.55	0.00
AA	+4.37	-3.78
BB	+1.75	-6.66
CC	-1.75	-6.66
DD	-4.37	-3.78
EE	-6.55	0.00
FF	-4.37	-3.78
GG	-1.75	-6.66
HH	0.00	+3.35
JJ	+2.18	0.00
KK	0.00	-3.35
LL	-2.18	0.00

29

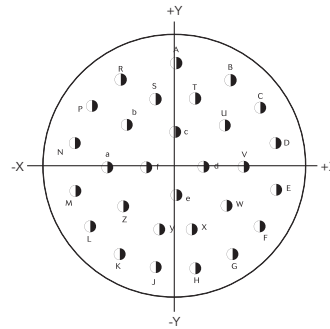

Ctc	X	Y
A	0.00	+12.22
B	+6.55	+10.31
C	+10.03	+7.04
D	+11.91	+2.77
E	+11.91	-2.77
F	+10.03	-7.04
G	+6.68	-10.31
H	+2.31	-11.99

Ctc	X	Y
J	-2.31	-11.99
K	-6.68	-10.31
L	-10.03	-7.04
M	-11.91	-2.77
N	-11.91	+2.77
P	-10.03	+7.04
R	-6.55	+10.31
S	-2.31	+8.15
T	+2.31	+8.15
U	+5.79	+4.93
V	+8.10	0.00
W	+6.10	-4.60
X	+2.31	-7.37
Y	-2.31	-7.37
Z	-6.10	-4.60
a	-8.10	0.00
b	-5.79	+4.93
c	0.00	+4.09
d	+3.40	0.00
e	0.00	-3.30
f	-3.40	0.00

35

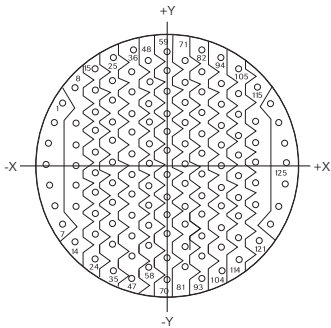

Ctc	X	Y
1	-12.17	+7.09
2	-13.21	+4.83
3	-13.87	+2.41
4	-14.10	0.00
5	-13.87	-2.41
6	-13.21	-4.83
7	-12.17	-7.09
8	-10.77	+9.07
9	-10.54	+4.83
10	-10.54	+2.41
11	-10.54	0.00
12	-10.54	-2.41
13	-10.54	-4.83
14	-10.77	-9.07
15	-8.43	+11.28
16	-8.43	+8.43
17	-8.43	+6.02
18	-8.43	+3.61
19	-8.43	+1.19
20	-8.43	-1.19
21	-8.43	-3.61
22	-8.43	-6.02
23	-8.43	-8.43
24	-8.43	-10.85
25	-6.32	+12.60
26	-6.32	+9.65

Ctc	X	Y
27	-6.32	+7.24
28	-6.32	+4.83
29	-6.32	+2.41
30	-6.32	0.00
31	-6.32	-2.41
32	-6.32	-4.83
33	-6.32	-7.24
34	-6.32	-9.65
35	-6.32	-12.07
36	-4.06	+13.49
37	-4.22	+10.85
38	-4.22	+8.43
39	-4.22	+6.02
40	-4.22	+3.61
41	-4.22	+1.19
42	-4.22	-1.19
43	-4.22	-3.61
44	-4.22	-6.02
45	-4.22	-8.43
46	-4.22	-10.85
47	-4.22	-13.26
48	-2.11	+12.07
49	-2.11	+9.65
50	-2.11	+7.24
51	-2.11	+4.83
52	-2.11	+2.41

Ctc	X	Y
53	-2.11	0.00
54	-2.11	-2.41
55	-2.11	-4.83
56	-2.11	-7.24
57	-2.11	-9.65
58	-2.11	-12.07
59	0.00	+13.26
60	0.00	+10.85
61	0.00	+8.43
62	0.00	+6.02
63	0.00	+3.61
64	0.00	+1.19
65	0.00	-1.19
66	0.00	-3.61
67	0.00	-6.02
68	0.00	-8.43
69	0.00	-10.85
70	0.00	-14.10
71	+2.11	+12.07
72	+2.11	+9.65
73	+2.11	+7.24
74	+2.11	+4.83
75	+2.11	+2.41
76	+2.11	0.00
77	+2.11	-2.41
78	+2.11	-4.83

Ctc	X	Y
79	+2.11	-7.24
80	+2.11	-9.65
81	+2.11	-12.07
82	+4.06	+13.49
83	+4.22	+10.85
84	+4.22	+8.43
85	+4.22	+6.02
86	+4.22	+3.61
87	+4.22	+1.19
88	+4.22	-1.19
89	+4.22	-3.61
90	+4.22	-6.02
91	+4.22	-8.43
92	+4.22	-10.85
93	+4.22	-13.26
94	+6.32	+12.60
95	+6.32	+9.65
96	+6.32	+7.24
97	+6.32	+4.83
98	+6.32	+2.41
99	+6.32	0.00
100	+6.32	-2.41
101	+6.32	-4.83
102	+6.32	-7.24
103	+6.32	-9.65

Ctc	X	Y
104	+6.32	-12.07
105	+8.43	+11.28
106	+8.43	+8.43
107	+8.43	+6.02
108	+8.43	+3.61
109	+8.43	+1.19
110	+8.43	-1.19
111	+8.43	-3.61
112	+8.43	-6.02
113	+8.43	-8.43
114	+8.43	-10.85
115	+10.77	+9.07
116	+10.54	+4.83
117	+10.54	+2.41
118	+10.54	0.00
119	+10.54	-2.41
120	+10.54	-4.83
121	+10.77	-9.07
122	+12.17	+7.09
123	+13.21	+4.83
124	+13.87	+2.41
125	+14.10	0.00
126	+13.87	-2.41
127	+13.21	-4.83
128	+12.17	-7.09

61

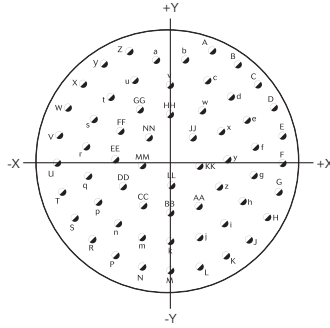

Ctc	X	Y	Ctc	X	Y	Ctc	X	Y	Ctc	X	Y	Ctc	X	Y
A	+4.98	+12.70	P	-6.58	-11.94	c	+4.39	+9.22	q	-9.96	-2.24	CC	-3.33	-5.92
B	+7.98	+11.05	R	-9.35	-9.93	d	+7.24	+7.19	r	-10.13	+1.17	DD	-5.79	-3.53
C	+10.49	+8.71	S	-11.53	-7.29	e	+9.19	+4.45	s	-9.19	+4.45	EE	-6.78	-0.25
D	+12.32	+5.84	T	-12.98	-4.17	f	+10.13	+1.17	t	-7.24	+7.19	FF	-6.02	+3.10
E	+13.39	+2.57	U	-13.61	-0.76	g	+9.96	-2.24	u	-4.39	+9.22	GG	-3.73	+5.66
F	+13.61	-0.76	V	-13.39	+2.57	h	+8.66	-5.41	v	0.00	+8.59	HH	0.00	+5.08
G	+12.98	-4.17	W	-12.32	+5.84	i	+6.38	-7.98	w	+3.73	+5.66	JJ	+2.67	+2.39
H	+11.53	-7.29	X	-10.49	+8.71	j	+3.38	-9.63	x	+6.02	+3.10	KK	+3.43	-1.04
J	+9.35	-9.93	Y	-7.98	-11.05	k	0.00	-10.21	y	+6.78	-0.25	LL	0.00	-3.35
K	+6.58	-11.94	Z	-4.98	+12.10	m	-3.38	-9.63	z	+5.79	-3.53	MM	-3.43	-1.04
L	+3.40	-13.18	a	-1.73	+11.53	n	-6.38	-7.98	AA	+3.33	-5.92	NN	-2.67	+2.39
M	0.00	-13.64	b	+1.73	+11.53	p	-8.66	-5.41	BB	0.00	-6.78	PP	0.00	0.00
N	-3.40	-13.18												

Cross reference list

Designation	SOURIAU	MIL-DTL-38999 Series II	NFC 93422 HE309
	Shell size Contact layout Orientation ↓ ↓ ↓ 8TX••X••X/X•	Shell size Contact layout Orientation ↓ ↓ ↓ MSXXXXXX••X••X/X•	Shell size & Contact layout Orientation ↓ ↓ HE309XXX••••X/X•XX
Square flange receptacle	8T0••B••P/S• 8T0••F••P/S• 8T0••C••P/S•	MS27472T••B••P/S• MS27472T••F••P/S• MS27472T••C••P/S•	HE30900T••••P/S•7M HE30900T••••P/S•6M HE30900T••••P/S•8M
In line receptacle	8T1••B••P/S• 8T1••F••P/S• 8T1••C••P/S•	-	-
Square flange receptacle not accepting backshells (rear mounting)	8T2••B••P/S• 8T2••F••P/S• 8T2••C••P/S•	MS27508E••B••P/S• MS27508E••F••P/S• MS27508E••C••P/S•	HE30905T••••P/S•7M HE30905T••••P/S•6M HE30905T••••P/S•8M
Square flange receptacle (rear mounting)	8T3••B••P/S• 8T3••F••P/S• 8T3••C••P/S•	MS27497T••B••P/S• MS27497T••F••P/S• MS27497T••C••P/S•	HE30903T••••P/S•7M HE30903T••••P/S•6M HE30903T••~•P/S•8M
Square flange receptacle not accepting backshells	8T4••B••P/S• 8T4••F••P/S• 8T4••C••P/S•	MS27499E••B••P/S• MS27499E••F••P/S• MS27499E••C••P/S•	HE30902T••~•P/S•7M HE30902T••~•P/S•6M HE30902T••~•P/S•8M
Plug with RFI shielding	8T5••B••P/S• 8T5••F••P/S• 8T5••C••P/S•	MS27484T••B••P/S• MS27484T••F••P/S• MS27484T••C••P/S•	HE309G6T••~•P/S•7M HE309G6T••~•P/S•6M HE309G6T••~•P/S•8M
Plug without RFI shielding	8T6••B••P/S• 8T6••F••P/S• 8T6••C••P/S•	MS27473T••B••P/S• MS27473T••F••P/S• MS27473T••C••P/S•	HE30906T••~•P/S•7M HE30906T••~•P/S•6M HE30906T••~•P/S•8M
Jam nut receptacle	8T7••B••P/S• 8T7••F••P/S• 8T7••C••P/S•	MS27474T••B••P/S• MS27474T••F••P/S• MS27474T••C••P/S•	HE30907T••~•P/S•7M HE30907T••~•P/S•6M HE30907T••~•P/S•8M
Square flange receptacle not accepting backshells (rear milling)	8T10••B••P/S• 8T10••F••P/S• 8T10••C••P/S•	-	-
Plug with RFI shielding not accepting backshells (rear milling)	8T15••B••P/S• 8T15••F••P/S• 8T15••C••P/S•	-	-
Plug without RFI shielding not accepting backshells (rear milling)	8T16••B••P/S• 8T16••F••P/S• 8T16••C••P/S•	-	-
Backshells	8TAB01A••W 8TAB01A••F	M85049/27••W M85049/27••N	-

8T SERIES

8T Series

Range Extension

■ Box mount interconnect solutions	48
■ Rack and panel	48
■ <i>microComp</i> ® Series	49
■ Double flange	49
■ Integrated clinch nut or helicoils	50
■ PC tail contacts without shoulder	50

Product range extension

Box Mount Interconnect Solutions

Box Interconnect Solutions: Inside/Outside.
Anything you need - we can do!

PCB terminations:

- . with many lengths and different types of plating.

Shape of connector can be adapted:

- . to meet the board application as double flange receptacles.

Receptacles with short shell:

- . to minimize space inside the box.

Any customized design:

- . to make box mount easier when space is a constraint.

Blindmate/hermetic/thin panel assembly solutions...



See «Box Mount Interconnect Solutions» catalog on www.souriau.com

Rack and Panel

Sealed rack and panel for blind connection.
A 100% scoop proof connector with quick connection in hard-to-reach areas.

Blind connection:

- . Easy and fast connection without any coupling/uncoupling between a float-mounting unit & a fixed unit.

Float-mounting unit - rack:

- . Female crimp contacts.
- . Mounting on the cabinet side.
- . Angular orientation with a key.
- . Possibility to supply rear accessories.

Misalignment catching:

- . Longitudinal, axial and angular.



See «38999 Series I - 8LT Series Rack & Panel» datasheet on www.souriau.com

Product range extension

microComp® Series

To respond to miniaturization and weight saving trends in aeronautical and defense applications SOURIAU has developed an innovative high density connector range.

Very light & high density:

- . Shell in composite (or aluminum).
- . Up to 66% lighter than HD D-Sub.
- . Very high density up to 40% smaller than HD D-Sub.

Excellent features:

- . With crimp removable contacts for wire AWG 24 to 28
- . Temperature up to 175°C
- . High vibration and shock withstanding
- . Standard MIL-STD 83513 accessories
- . Compatible with high speed data rates (Gigabit Ethernet...)

Quick connect version for harsh environment:

- . 104 contacts push-push



See «microComp® Series - Miniature High Density» datasheet on www.souriau.com

Double Flange

Double flange solution for PCB mount. Specially designed for PCB applications in harsh environments, decoupling vibration from the board.

Excellent mechanical performance:

- . Standoffs integrated into the connector.
- . No risk of breaking contacts and no risk of micro-cuts.

Design flexibility:

- . Square flange or Jam nut versions available.
- . Versatile contact length options.

A wide range:

- . Available in aluminum with a range of layouts from shell size 9 to 25.

User friendly:

- . Easy to assemble & time saving.

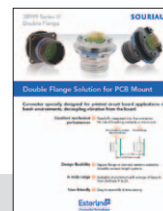

See «38999 Series III - Double Flange» datasheet on www.souriau.com

Product range extension

Integrated Clinch Nut or Helicoils

Integrated clinch nut solution for box mount. Equivalent mounting retention of the receptacle ensured with only 4 clinch nuts. Designed for severe applications.

User friendly:

- . Easy to install.

Selflocking:

- . Fast and secure.

Reduced mounting hardware:

- . Elimination of nuts and washers.

Foreign Object Debris reduction



See «38999 Series III - Clinch Nut or Helicoils» datasheet on www.souriau.com

PC Tail Contacts without Shoulder

Pin & socket PCB contacts without shoulder #22D and #20 as per MIL-DTL-38999 Series I, II & III. Contacts without shoulder allows a more flexible mounting on variable PCB thicknesses or depths.

Ruggedized contacts:

- . Material: copper alloy
- . Finish: gold per MIL-G-45204 type I class 1 over nickel plate
- . Sleeve: stainless steel

Flexible mounting:

- . Various PCB thicknesses.
- . Multiple PCB positioning.



See «PCB contacts without shoulder» datasheet on www.souriau.com

Reliable People, Reliable Solutions



Your local contact



Our contribution to environmental protection:
This catalog is printed on PEFC certified paper
Advancement of sustainable wood cultivation. www.pefc.org

www.esterline-connection-technologies.com
technical-emear-ect@esterline.com (Europe - Asia - Africa)
technical-americas-ect@esterline.com (North America)



SOURIAU