

2

1

DATE	REV	ECN	APP'D. BY
9-8-15	X0	-	DHG
2-4-16	A0	10528	ADB

B

B

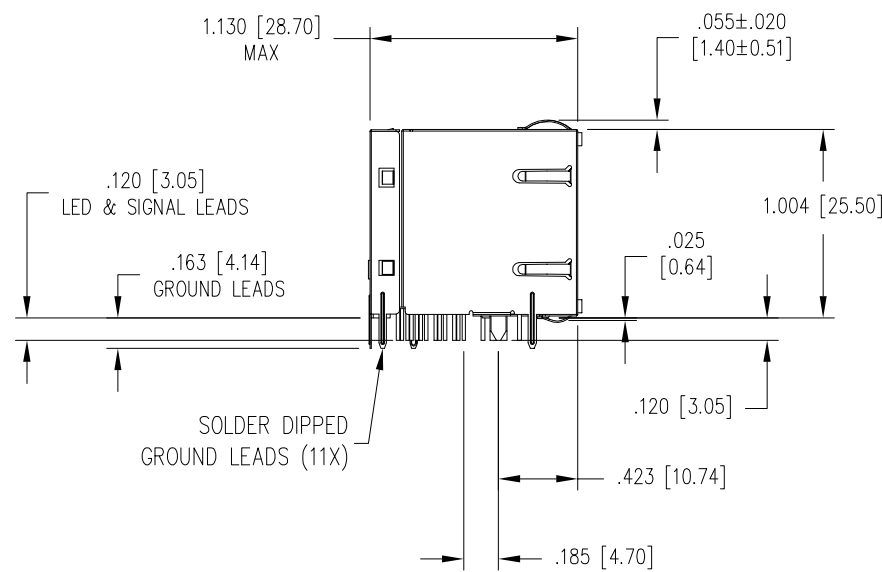

.055±.020 [1.40±0.51]

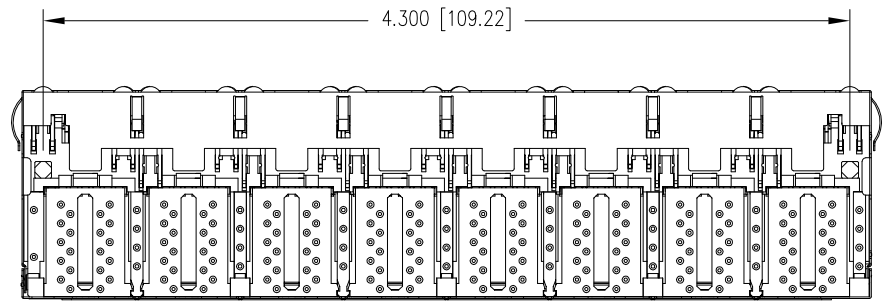
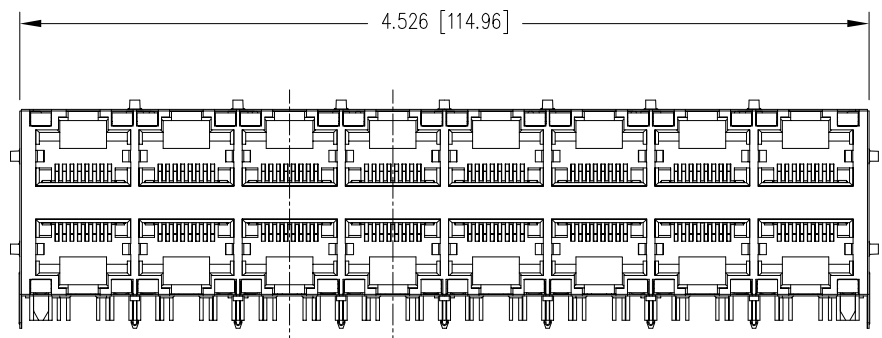
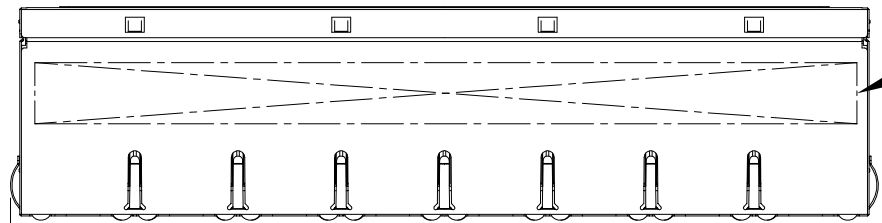

NOTES:

- CONNECTOR MATERIALS:  
HOUSING: THERMOPLASTIC UL94 V-0  
CONTACTS/SHIELD: COPPER ALLOY  
SHIELD PLATING: NICKEL OR "REFLOW" TIN  
CONTACT PLATING: SELECTIVE GOLD OR EQUIVALENT IN THE CONTACT AREA  
SEE CHART FOR PART NUMBER
  - FOR PRODUCT SPECIFICATIONS SEE PR022-01.
  - DIMENSIONS AND TOLERANCES COMPLY WITH TIA-1096 STANDARD.
  - THE SUGGESTED PANEL OPENING IS INTENDED TO GIVE USER THE ABILITY TO HAVE REASONABLE JACK/PANEL CLEARANCES, YET MAINTAIN GROUNDING CAPABILITY. THESE VARIABLES CAN BE ADJUSTED IN EITHER DIRECTION BUT MAY CARRY SOME CONSEQUENCES IN THE FORM OF LOWER MATING FORCES OR TIGHTER ASSEMBLY TOLERANCES.
- △ MARK PART WITH MFG LOGO, MFG NAME, PART NUMBER, AND DATE CODE.

A

A

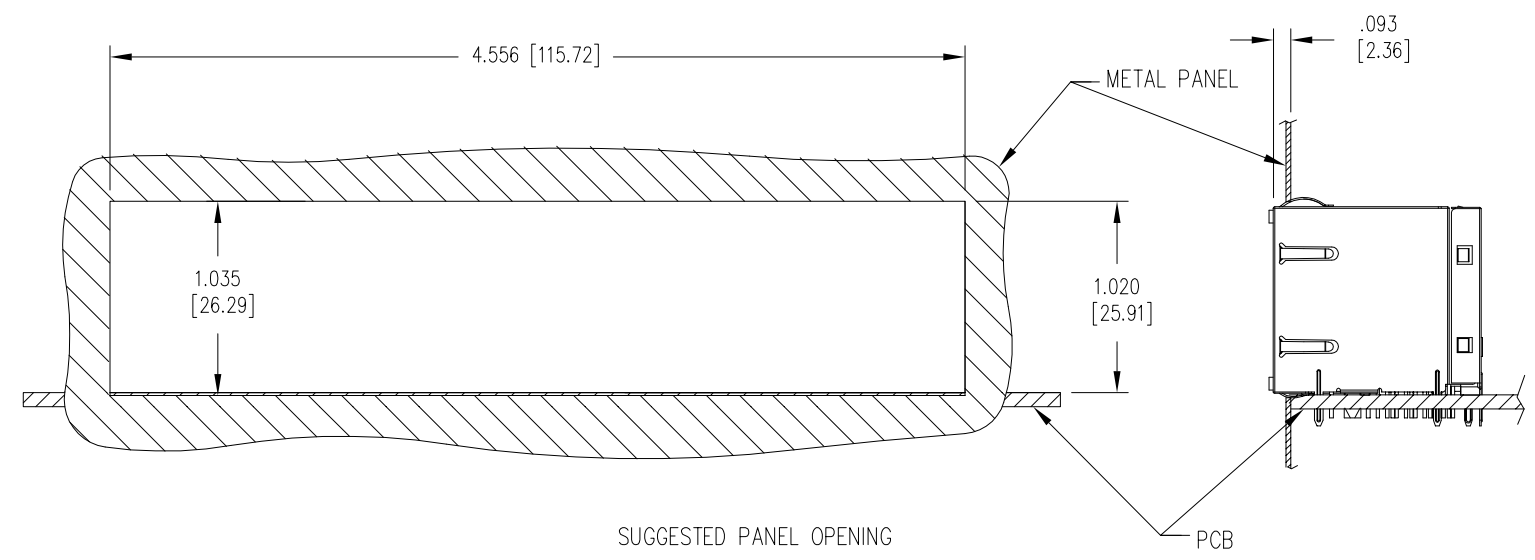

50 MICRO-INCHES [1.27um]	SS-74500-022
CONTACT PLATING IN MATING AREA	PART NUMBER

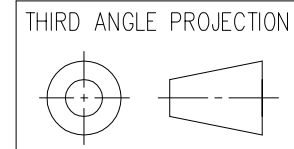

DO NOT SCALE DRAWING  
DRAWING IS SUBJECT TO CHANGE WITHOUT NOTICE

DIMENSIONS: INCHES [METRIC]

UNLESS OTHERWISE SPECIFIED TOLERANCES ARE ±.010 [0.25] ANGLES ARE ± 1°

SHEET NO. 1 OF 3

TITLE: 2X8 SHIELDED STACKJACK WITH GREEN/YELLOW UPPER AND LOWER LEADS

THIS DRAWING AND THE SUBJECT MATTER SHOWN THEREON ARE CONFIDENTIAL AND THE PROPRIETARY PROPERTY OF STEWART CONNECTOR AND SHALL NOT BE REPRODUCED, COPIED, OR USED IN ANY MANNER WITHOUT PRIOR WRITTEN CONSENT OF STEWART CONNECTOR. THIS PRODUCT MAY BE PROTECTED BY ONE OR MORE OF THE FOLLOWING US PATENTS: 5791942 6217391 6368159 6419526 6602097 687722 6964587 7048590 7086909 7568950 7686650 OTHER PATENTS MAY BE PENDING.

DRN BY: ADB	DATE 9-4-15
APPD BY: DHG	DATE 9-8-15
DWG NO. CT740219	REV. A0



2

1

AutoCAD

LED INFORMATION

LED 2 & 4 POLARITY			LED 1 & 3 POLARITY		
PIN 9	PIN 10	COLOR	PIN 11	PIN 12	COLOR
+	-	GREEN	+	-	YELLOW

LED 2 & 4  
 VF (FORWARD VOLTAGE) IF=20mA GREEN 2.2V TYP.  
 λD (DOMINANT WAVELENGTH) IF=20mA GREEN 570nm TYP.

LED 1 & 3  
 VF (FORWARD VOLTAGE) IF=20mA YELLOW 2.1V TYP.  
 λD (DOMINANT WAVELENGTH) IF=20mA YELLOW 590nm TYP.

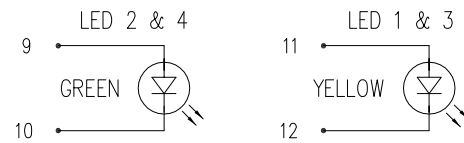

PORT ASSIGNMENT (FRONT VIEW OF JACK)

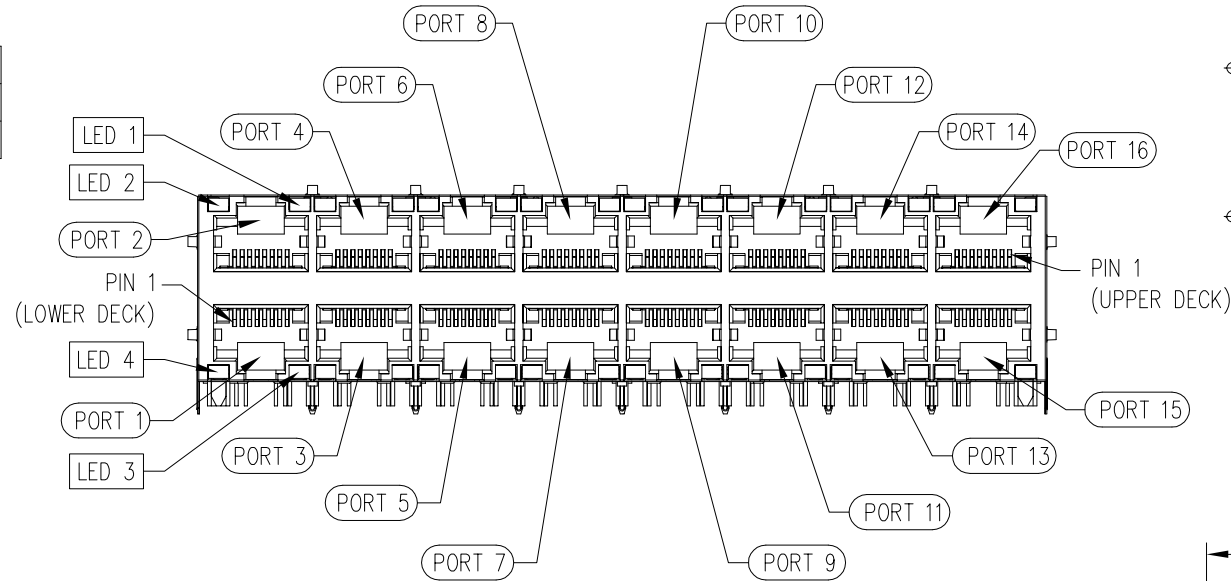

PORT ASSIGNMENT (PCB - COMPONENT SIDE VIEW)

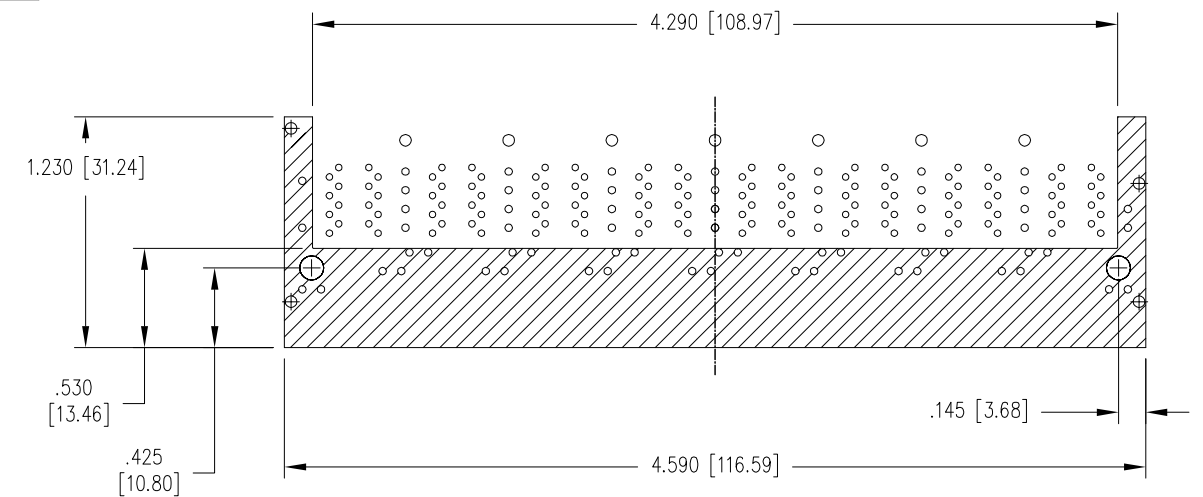
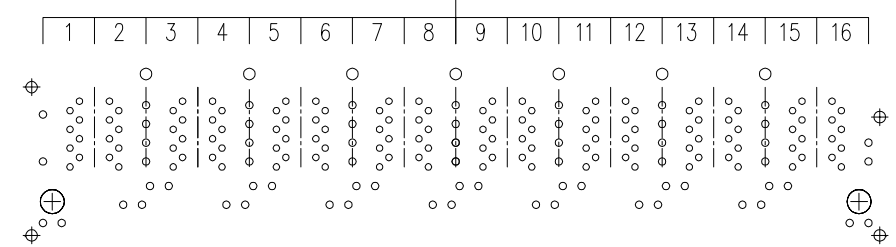

THE SHADED AREA ON THE CUSTOMER BOARD IS RECOMMENDED TO BE CLEAR OF ANY VIA HOLE OR COMPONENT PAD.

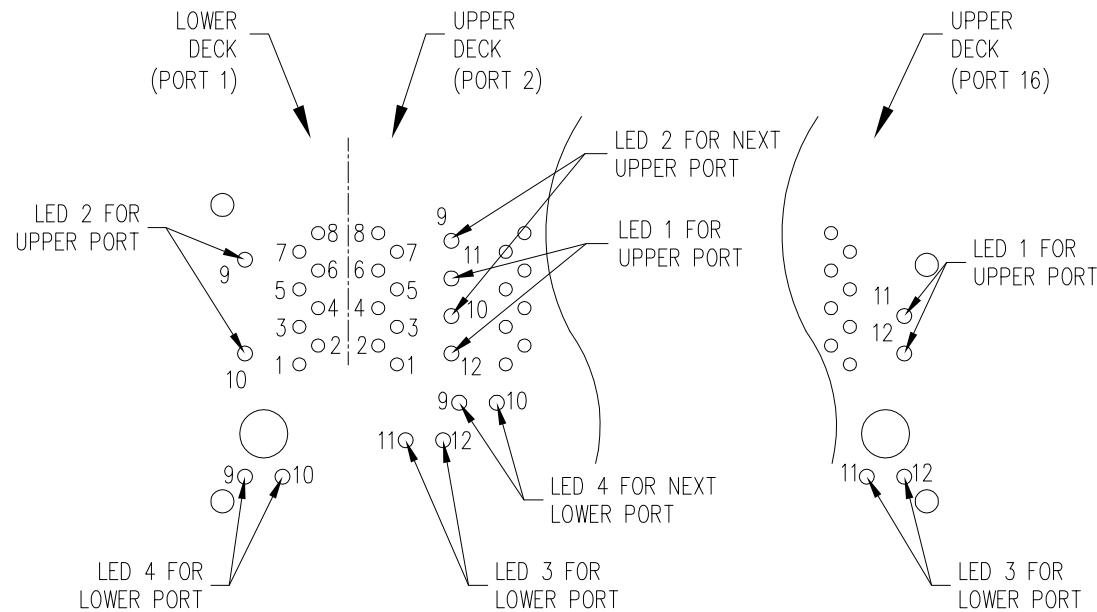

PIN-OUT INFORMATION (PCB - COMPONENT SIDE VIEW)



THIRD ANGLE PROJECTION

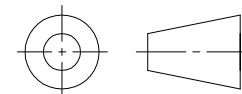

1118 Susquehanna Trail South  
 Glen Rock, PA 17327-9199  
 (717) 235-7512

<http://www.stewartconnector.com>

DO NOT SCALE DRAWING  
 DRAWING IS SUBJECT TO CHANGE WITHOUT NOTICE

TITLE: 2X8 SHIELDED STACKJACK WITH GREEN/YELLOW UPPER AND LOWER LEDS

DIMENSIONS: INCHES [METRIC]

THIS DRAWING AND THE SUBJECT MATTER SHOWN THEREON ARE CONFIDENTIAL AND THE PROPRIETARY PROPERTY OF STEWART CONNECTOR AND SHALL NOT BE REPRODUCED, COPIED, OR USED IN ANY MANNER WITHOUT PRIOR WRITTEN CONSENT OF STEWART CONNECTOR. THIS PRODUCT MAY BE PROTECTED BY ONE OR MORE OF THE FOLLOWING US PATENTS: 5791942 6217391 6368159 6419526 6602097 687722 6964587 7048590 7086909 7568950 7686650 OTHER PATENTS MAY BE PENDING.

DRN BY: ADB DATE 9-4-15

APPD BY: DHG DATE 9-8-15

DWG NO. CT740219 REV. A0

SHEET NO. 2 OF 3

B

B

A

A

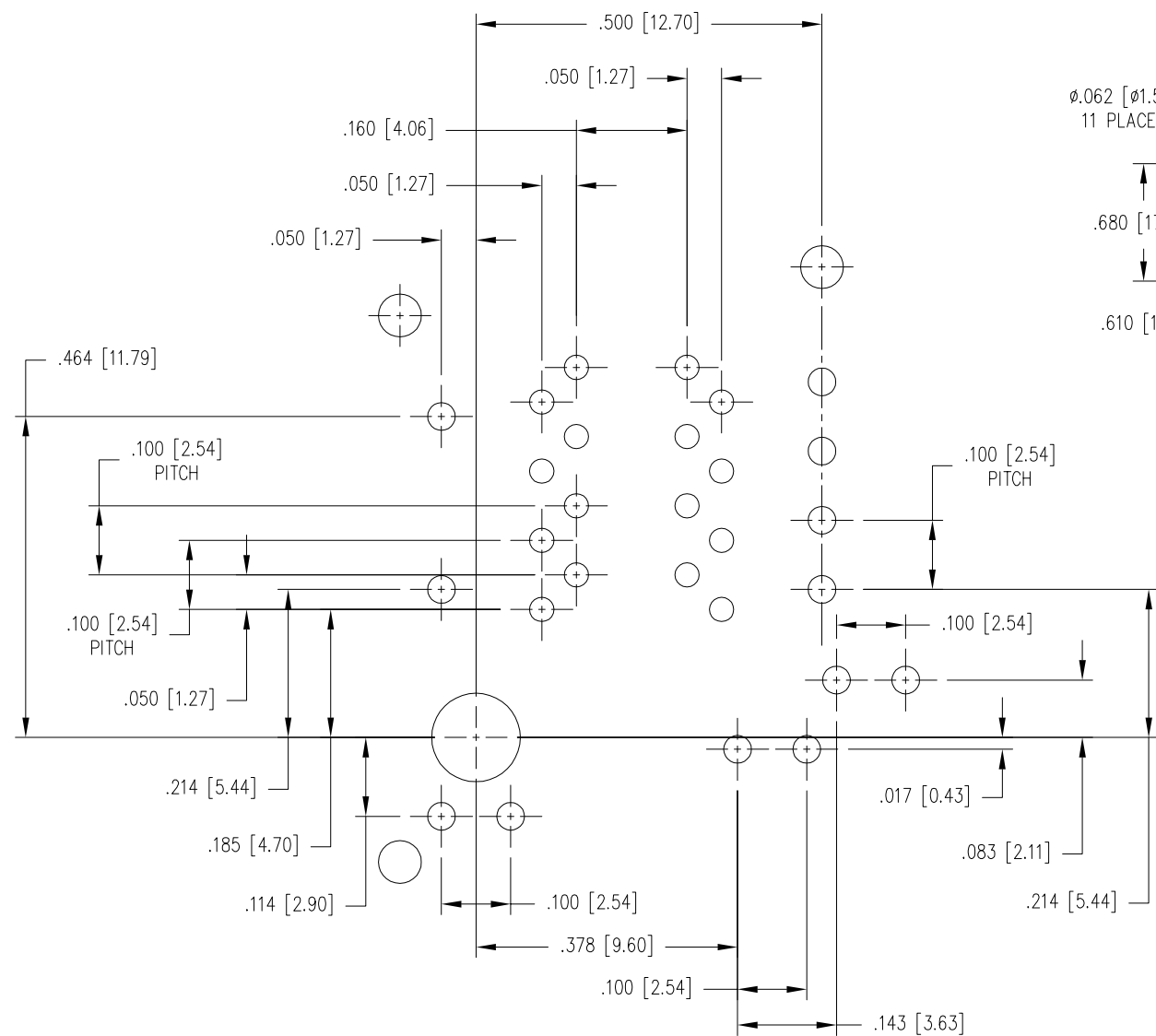

DETAIL A - TYPICAL HOLE LAYOUT  
SCALE 4X

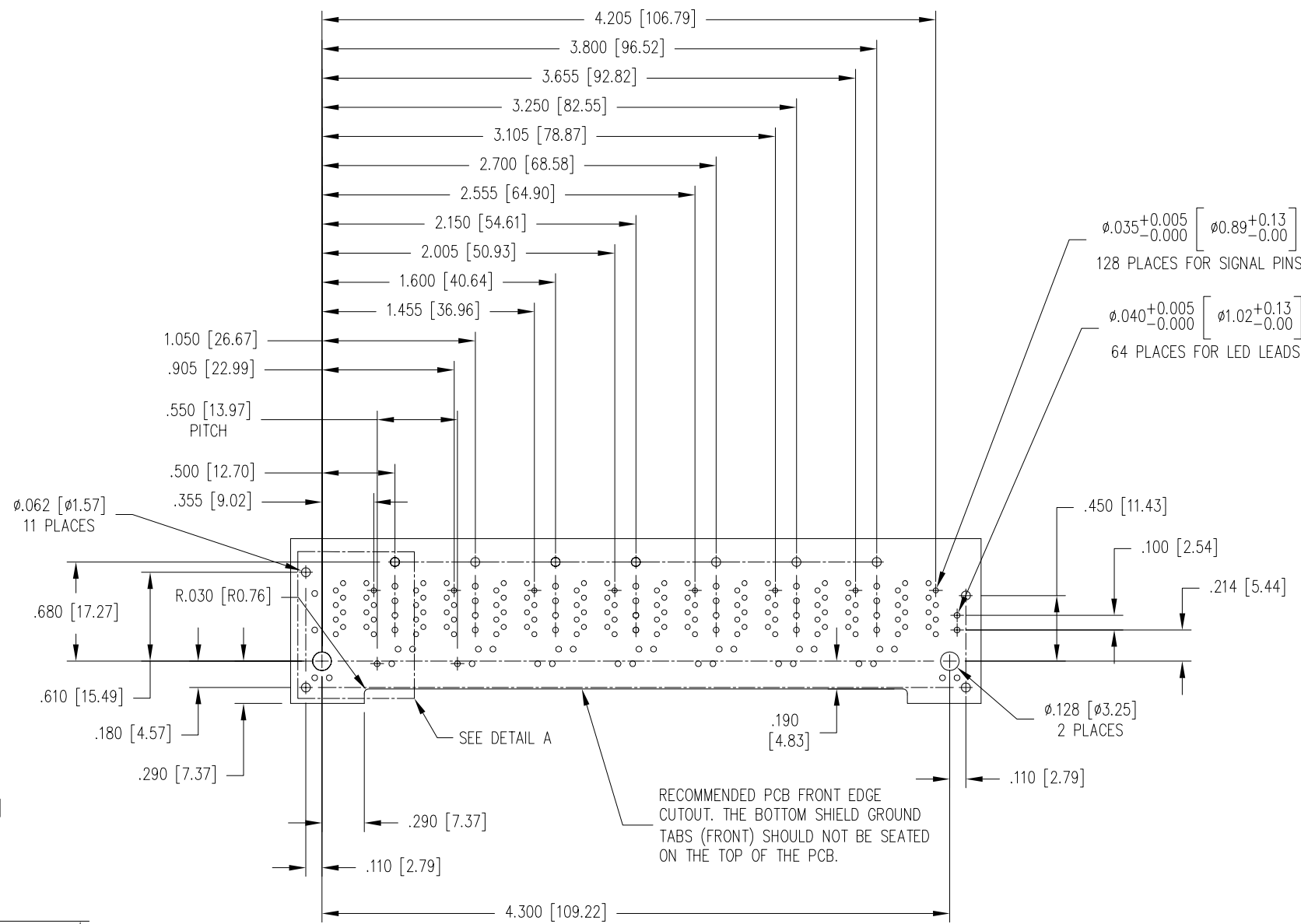

P.C.B. RECOMMENDED HOLE LAYOUT  
(COMPONENT SIDE VIEW)

ALL CENTERLINE DIMENSIONS ARE BASIC.

ALL HOLE POSITIONS ARE  $\pm \phi .006 [0.15]$

RECOMMENDED PCB FRONT EDGE  
CUTOUT. THE BOTTOM SHIELD GROUND  
TABS (FRONT) SHOULD NOT BE SEATED  
ON THE TOP OF THE PCB.

$\phi .035^{+0.005}_{-0.000} [\phi 0.89^{+0.13}_{-0.00}]$   
128 PLACES FOR SIGNAL PINS

$\phi .040^{+0.005}_{-0.000} [\phi 1.02^{+0.13}_{-0.00}]$   
64 PLACES FOR LED LEADS



THIRD ANGLE PROJECTION 	 stewart CONNECTOR a bel group	11118 Susquehanna Trail South Glen Rock, PA 17327-9199 (717) 235-7512 <a href="http://www.stewartconnector.com">http://www.stewartconnector.com</a>
DO NOT SCALE DRAWING DRAWING IS SUBJECT TO CHANGE WITHOUT NOTICE	TITLE: 2X8 SHIELDED STACKJACK WITH GREEN/YELLOW UPPER AND LOWER LEADS	
DIMENSIONS: INCHES [METRIC]	THIS DRAWING AND THE SUBJECT MATTER SHOWN THEREON ARE CONFIDENTIAL AND THE PROPRIETARY PROPERTY OF STEWART CONNECTOR AND SHALL NOT BE REPRODUCED, COPIED, OR USED IN ANY MANNER WITHOUT PRIOR WRITTEN CONSENT OF STEWART CONNECTOR. THIS PRODUCT MAY BE PROTECTED BY ONE OR MORE OF THE FOLLOWING US PATENTS: 5791942 6217391 6368159 6419526 6602097 687722 6964587 7048590 7086909 7568950 7686650 OTHER PATENTS MAY BE PENDING.	DRN BY: ADB DATE 9-4-15 APPD BY: DHG DATE 9-8-15
UNLESS OTHERWISE SPECIFIED TOLERANCES ARE $\pm .010 [0.25]$ ANGLES ARE $\pm 1^\circ$	SHEET NO. 3 OF 3	DWG NO. CT740219 REV. A0